









+ ROLLING BEARINGS



Technical Information	Page A003	Technical Information
Deep Groove Ball Bearings	B005	
Angular Contact Ball Bearings	B073	
Self-Aligning Ball Bearings	B119	
Cylindrical Roller Bearings	B141	
Tapered Roller Bearings	B199	
Spherical Roller Bearings	B275	
Thrust Ball Bearings	B313	
Ball Bearing Units	B359	
Accessories for Rolling Bearings	B376	Sleeves 
NSK Products and Appendices	C002	Appendices

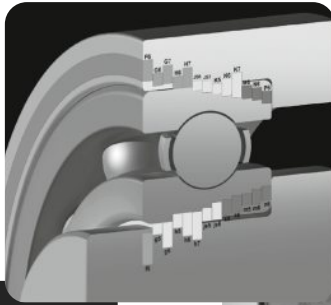
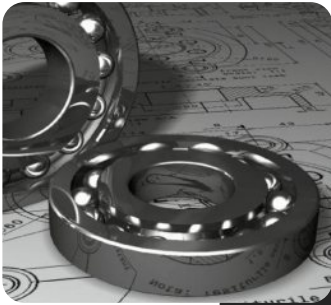

Part A

TECHNICAL INFORMATION

1. Types and Features of Rolling Bearings	A 005
2. Selection of Bearing Types	A 019
3. Selection of Bearing Arrangement	A 025
4. Selection of Bearing Size	A 030
5. Speeds	A 097
6. Boundary Dimensions and Identifying Numbers for Bearings	A 103
7. Bearing Tolerances	A 125
8. Fits and Internal Clearances	A 153
9. Preload	A 191
10. Friction	A 215
11. Lubrication	A 227
12. Bearing Materials	A 243
13. Design of Shafts and Housings	A 269



1. TYPES AND FEATURES OF ROLLING BEARINGS

1.1 Design and Classification	A 006
1.2 Characteristics of Rolling Bearings	A 006
1.3 Contact Angle and Bearing Types	A 016
1.4 Types of Load on Bearings	A 017

1. Types and Features of Rolling Bearings

1.1 Design and Classification

Rolling bearings generally consist of two rings, rolling elements, and a cage, and they are classified into radial bearings or thrust bearings depending on the direction of the main load. In addition, depending on the type of rolling elements, they are classified into ball bearings or roller bearings, and they are further segregated by differences in their design or specific purpose.

The most common bearing types and nomenclature of bearing parts are shown in Fig.1.1, and a general classification of rolling bearings is shown in Fig. 1.2.

1.2 Characteristics of Rolling Bearings

Compared with plain bearings, rolling bearings have the following major advantages:

- (1) Their starting torque or friction is low and the difference between the starting torque and running torque is small.
- (2) With the advancement of worldwide standardization, rolling bearings are internationally available and interchangeable.
- (3) Maintenance, replacement, and inspection are easy because the structure surrounding rolling bearings is simple.
- (4) Many rolling bearings are capable of taking both radial and axial loads simultaneously or independently.
- (5) Rolling bearings can be used under a wide range of temperatures.
- (6) Rolling bearings can be preloaded to produce a negative clearance and achieve greater rigidity.

Furthermore, different types of rolling bearings have their own individual advantages. The features of the most common rolling bearings are described on Pages A010 to A013 and in Table 1.1 (Pages A014 and A015).

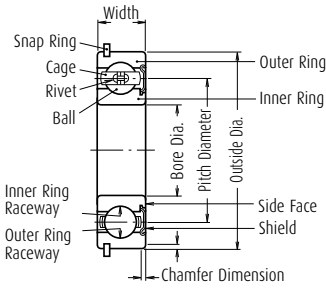

Single-Row Deep Groove Ball Bearing

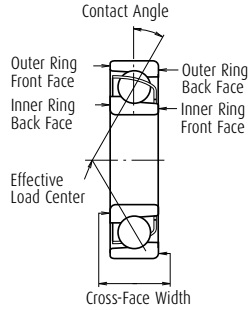

Single-Row Angular Contact Ball Bearing

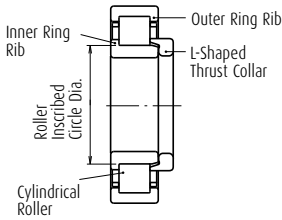

Cylindrical Roller Bearing

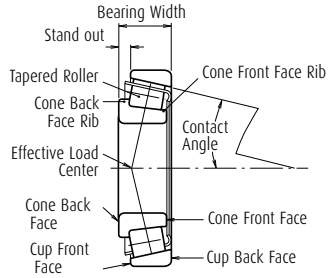

Tapered Roller Bearing

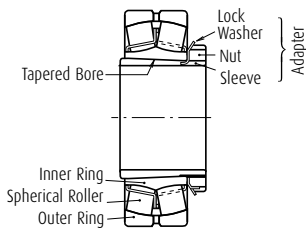

Spherical Roller Bearing

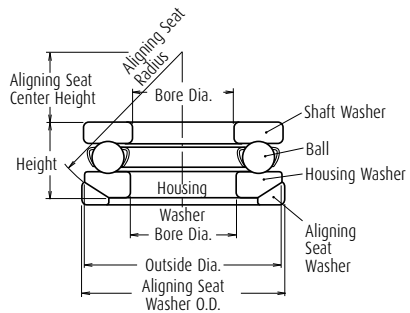

Single-Direction Thrust Ball Bearing

Fig. 1.1 Name of Bearing Parts

Types and Features of Rolling Bearings

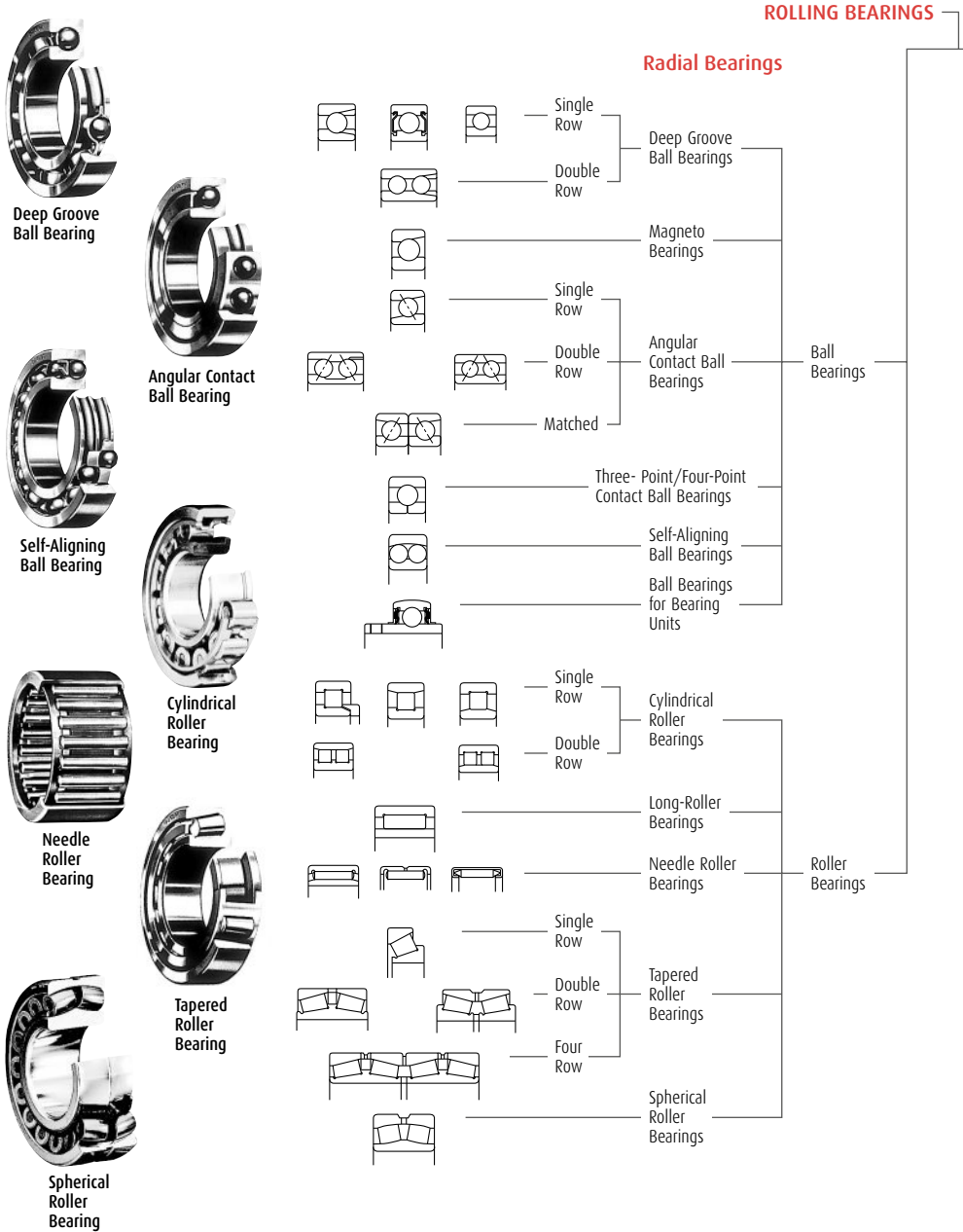
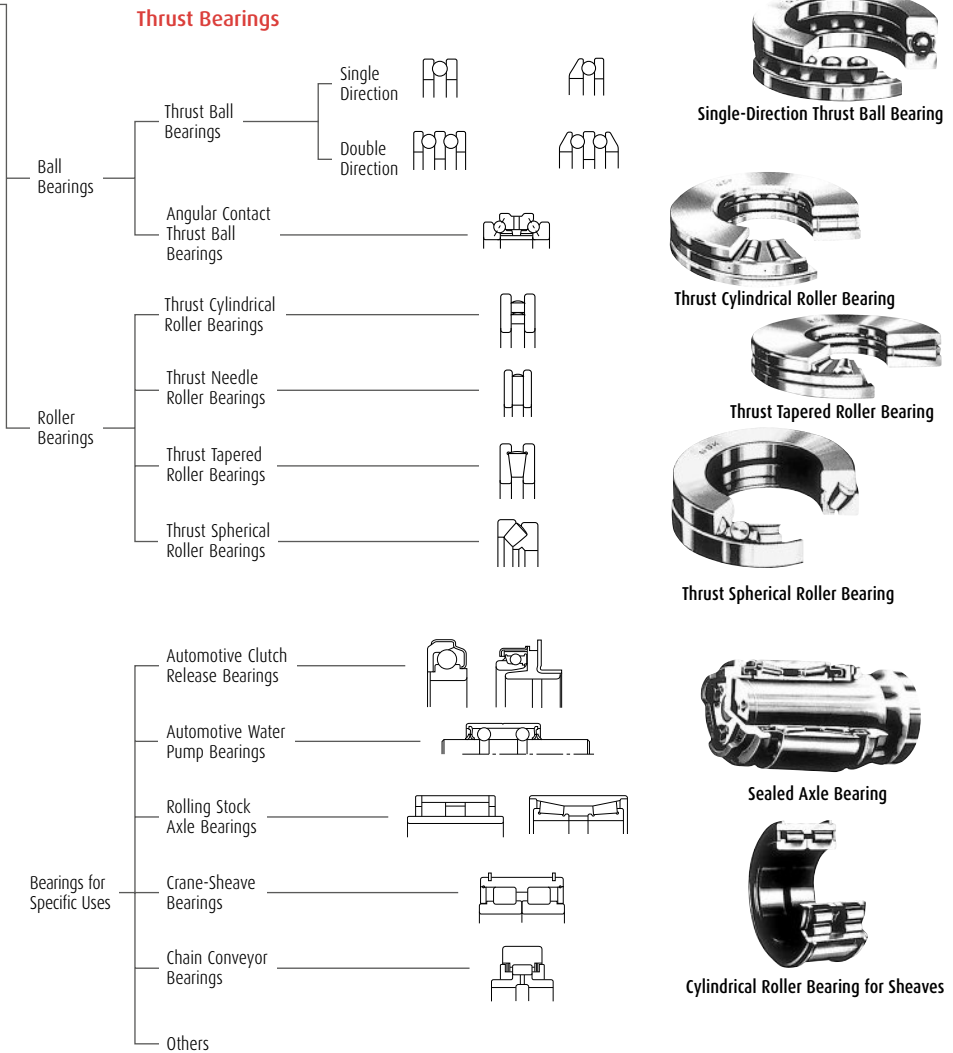

Fig. 1.2 Classification of Rolling Bearings

Thrust Bearings



Types and Features of Rolling Bearings

Single-Row Deep Groove Ball Bearings

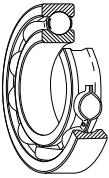

Single-row deep groove ball bearings are the most common type of rolling bearings. Their use is very widespread. The raceway grooves on both the inner and outer rings have circular arcs of slightly larger radius than that of the balls. In addition to radial loads, axial loads can be imposed in either direction. Because of their low torque, they are highly suitable for applications where high speeds and low power loss are required.

In addition to open type bearings, these bearings often have steel shields or rubber seals installed on one or both sides and are prelubricated with grease. Also, snap rings are sometimes used on the periphery. As to cages, pressed steel ones are the most common.

Magneto Bearings

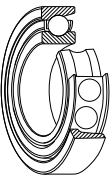

The inner groove of magneto bearings is a little shallower than that of deep groove bearings. Since the outer ring has a shoulder on only one side, the outer ring may be removed. This is often advantageous for mounting. In general, two such bearings are used in duplex pairs. Magneto bearings are small bearings with a bore diameter of 4 to 20 mm and are mainly used for small magnetos, gyroscopes, instruments, etc. Pressed brass cages are generally used.

Single-Row Angular Contact Ball Bearings

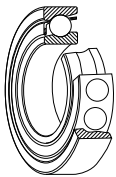

Individual bearings of this type are capable of taking radial loads and also axial loads in one direction. Four contact angles of 15°, 25°, 30°, and 40° are available. The larger the contact angle, the higher the axial load capacity. For high speed operation, however, the smaller contact angles are preferred. Usually, two bearings are used in duplex pairs, and the clearance between them must be adjusted properly.

Pressed-steel cages are commonly used, however, for high precision bearings with a contact angle less than 30°, polyamide resin cages are often used.

Duplex Bearings

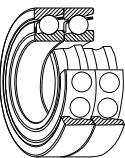

A combination of two radial bearings is called a duplex pair. Usually, they are formed using angular contact ball bearings or tapered roller bearings. Possible combinations include face-to-face, which have the outer ring faces together (type DF), back-to-back (type DB), or both front faces in the same direction (type DT). DF and DB duplex bearings are capable of taking radial loads and axial loads in either direction. Type DT is used when there is a strong axial load in one direction and it is necessary to impose the load equally on each bearing.

Double-Row Angular Contact Ball Bearings

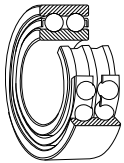

Double-row angular contact ball bearings are basically two single-row angular contact ball bearings mounted back-to-back except that they have only one inner ring and one outer ring, each having raceways. They can take axial loads in either direction.

Four-Point Contact Ball Bearings

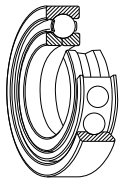

The inner and outer rings of four-point contact ball bearings are separable because the inner ring is split in a radial plane. They can take axial loads from either direction. The balls have a contact angle of 35° with each ring. Just one bearing of this type can replace a combination of face-to-face or back-to-back angular contact bearings.

Machined brass cages are generally used.

Self-Aligning Ball Bearings

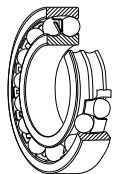

The inner ring of this type of bearing has two raceways and the outer ring has a single spherical raceway with its center of curvature coincident with the bearing axis. Therefore, the axis of the inner ring, balls, and cage can deflect to some extent around the bearing center. Consequently, minor angular misalignment of the shaft and housing caused by machining or mounting error is automatically corrected.

This type of bearing often has a tapered bore for mounting using an adapter sleeve.

Cylindrical Roller Bearings

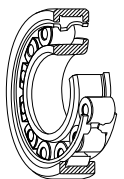

In bearings of this type, the cylindrical rollers are in linear contact with the raceways. They have a high radial load capacity and are suitable for high speeds.

There are different types designated NU, NJ, NUP, N, NF for single-row bearings, and NNU, NN for double-row bearings depending on the presence or absence of side ribs.

The outer and inner rings of all types are separable.

Some cylindrical roller bearings have no ribs on either the inner or outer ring, so the rings can move axially relative to each other. These can be used as free-end bearings. Cylindrical roller bearings, in which either the inner or outer rings has two ribs and the other ring has one, are capable of taking some axial load in one direction. Double-row cylindrical roller bearings have high radial rigidity and are used primarily for precision machine tools.

Pressed steel or machined brass cages are generally used, but sometimes molded polyamide cages are also used.

Types and Features of Rolling Bearings

Needle Roller Bearings

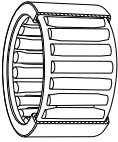

Needle roller bearings contain many slender rollers with a length 3 to 10 times their diameter. As a result, the ratio of the bearing outside diameter to the inscribed circle diameter is small, and they have a rather high radial load capacity.

There are numerous types available, and many have no inner rings. The drawn-cup type has a pressed steel outer ring and the solid type has a machined outer ring. There are also cage and roller assemblies without rings. Most bearings have pressed steel cages, but some are without cages.

Tapered Roller Bearings

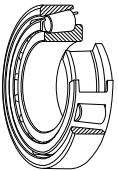

Bearings of this type use conical rollers guided by a back-face rib on the cone. These bearings are capable of taking high radial loads and also axial loads in one direction. In the HR series, the rollers are increased in both size and number giving it an even higher load capacity.

They are generally mounted in pairs in a manner similar to single-row angular contact ball bearings. In this case, the proper internal clearance can be obtained by adjusting the axial distance between the cones or cups of the two opposed bearings. Since they are separable, the cone assemblies and cups can be mounted independently.

Depending upon the contact angle, tapered roller bearings are divided into three types called normal angle, medium angle, and steep angle. Double-row and four-row tapered roller bearings are also available.

Pressed steel cages are generally used.

Spherical Roller Bearings

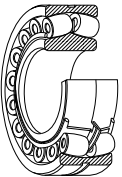

These bearings have barrel-shaped rollers between the inner ring, which has two raceways, and the outer ring which has one spherical raceway. Since the center of curvature of the outer ring raceway surface coincides with the bearing axis, they are self-aligning in a manner similar to that of self-aligning ball bearings. Therefore, if there is deflection of the shaft or housing or misalignment of their axes, it is automatically corrected so excessive force is not applied to the bearings.

Spherical roller bearings can take not only heavy radial loads, but also some axial loads in either direction. They have excellent radial load-carrying capacity and are suitable for use where there are heavy or impact loads.

Some bearings have tapered bores and may be mounted directly on tapered shafts or cylindrical shafts using adapters or withdrawal sleeves.

Pressed steel and machined brass cages are used.

Single-Direction Thrust Ball Bearings

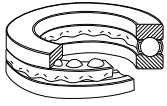

Single-direction thrust ball bearings are composed of washer-like bearing rings with raceway grooves. The ring attached to the shaft is called the shaft washer (or inner ring) while that attached to the housing is called the housing washer (or outer ring).

Double-Direction Thrust Ball Bearings

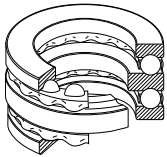

In double-direction thrust ball bearings, there are three rings with the middle one (center ring) being fixed to the shaft.

There are also thrust ball bearings with an aligning seat washer beneath the housing washer in order to compensate for shaft misalignment or mounting error.

Pressed steel cages are usually used in the smaller bearings and machined cages in the larger ones.

Spherical Thrust Roller Bearings

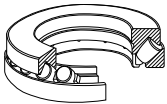





















































































These bearings have a spherical raceway in the housing washer and barrel-shaped rollers obliquely arranged around it. Since the raceway in the housing washer is spherical, these bearings are self-aligning. They have a very high axial load capacity and are capable of taking moderate radial loads when an axial load is applied.

Pressed steel cages or machined brass cages are usually used.

Types and Features of Rolling Bearings

Table 1.1 Types and Characteristics of Rolling Bearings

Features		Deep Groove Ball Bearings		Magneto Bearings	Angular Contact Ball Bearings	Double-Row Angular Contact Ball Bearings	Duplex Angular Contact Ball Bearings	Four-Point Contact Ball Bearings	Self-Aligning Ball Bearings	Cylindrical Roller Bearings	Double-Row Cylindrical Roller Bearings	Cylindrical Roller Bearings with Single Rib
												
Load Capacity	Radial Loads											
	Axial Loads											
	Combined Loads											
High Speeds												
High Accuracy												
Low Noise and Torque												
Rigidity												
Angular Misalignment												
Self-Aligning Capability								i				
Ring Separability			i					i		i	i	i
Fixed-End Bearing		i			i	i	i	i				
Free-End Bearing		I			I	I	I	I		i	i	
Tapered Bore in Inner Ring									i		i	
Remarks			Two bearings are usually mounted in opposition.	Contact angles of 15°, 25°, 30°, and 40°. Two bearings are usually mounted in opposition. Clearance adjustment is necessary.		Combination of DF and DT pairs is possible, but use on free-end is not possible.	Contact angle of 35°			Including N type	Including NNU type	Including NF type
Page No.		B005 B055	B005 B052	B072	B074 B108	B074	B074 B114	B120	B142	B142	B142 B176	B142

 Excellent
  Good
  Fair
  Poor
  Impossible
  One direction only
  Two directions

i Applicable
 I Applicable, but it is necessary to allow shaft contraction/elongation at fitting surfaces of bearings.

Cylindrical Roller Bearings with Thrust Collars	Needle Roller Bearings	Tapered Roller Bearings	Double-and Multiple-Row Tapered Roller Bearings	Spherical Roller Bearings	Thrust Ball Bearings	Thrust Ball Bearings with Aligning Seat	Double-Direction Angular Contact Thrust Ball Bearings	Thrust Cylindrical Roller Bearings	Thrust Tapered Roller Bearings	Thrust Spherical Roller Bearings	Page No.
											-
	×										-
	×				×	×	×	×	×	○	-
					×	×		○	○	○	A022 A098
											A023 A126 A151
											A023
											A023 A192
	○		○		×		×	×	×		A022
				i		i				i	A022
i	i	i	i		i	i	i	i	i	i	A023 A024
i			i	i							A026 to A029
	i		I	I							A026 to A029
				i							A150 B008 B012
Including NUP type		Two bearings are usually mounted in opposition. Clearance adjustment is necessary.	KH, KV types are also available but use on free-end is impossible.					Including needle roller thrust bearings		To be used with oil lubrication	
B142		B200	B200 B264	B276	B314	B314	-	B332	B340	B350	

Types and Features of Rolling Bearings

1.3 Contact Angle and Bearing Types

The contact angle (α) refers to the angle between a vertical plane of the rotation axis of the bearing and a straight line between the points where the rolling element comes in contact with the inner ring raceway and outer ring raceway. Radial bearings and thrust bearings are classified depending on the size of the contact angle.

Figure 1.3 shows the relation between contact angle and loading direction on the bearing.

Radial bearing α : Less than 45°
(A primarily radial load is applied.)

Thrust bearing α : Over 45°
(A primarily axial load is applied.)

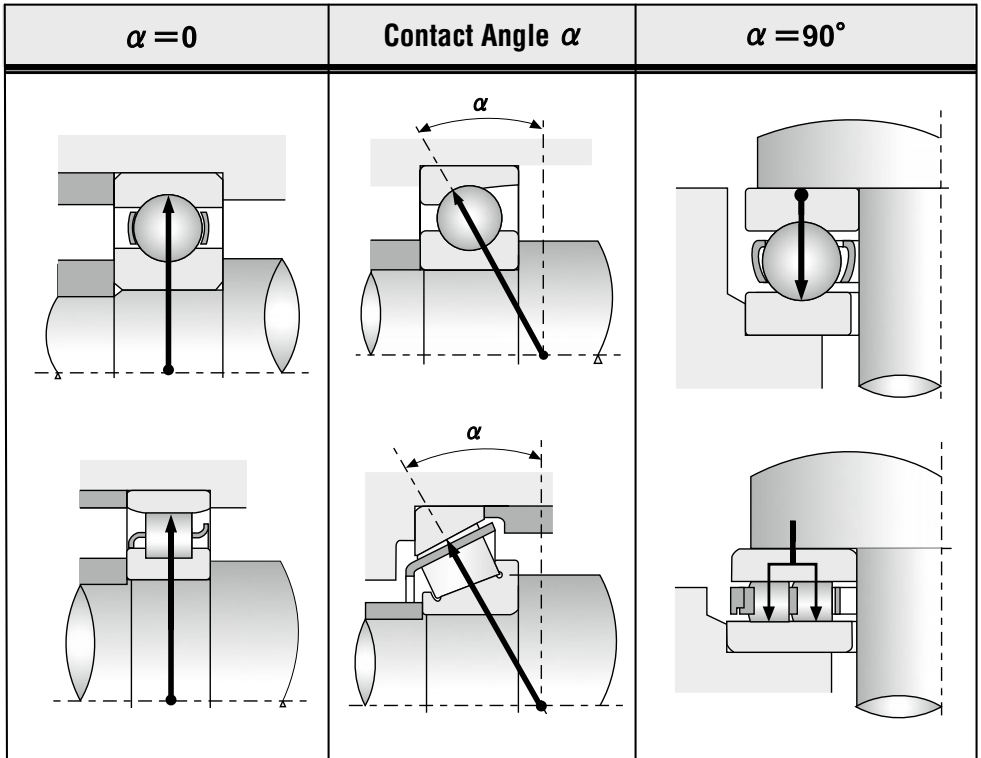

Fig. 1.3 Contact Angle α

1.4 Types of Load on Bearings

An example deep groove ball bearing is shown.

Figure 1.4 shows the types of the load applied to a rolling bearing.

- (a) Radial load
- (b) Axial load
- (c) Combined radial and axial load
- (d) Moment load

It is important to select the optimum bearing type according to the type and magnitude of the load.

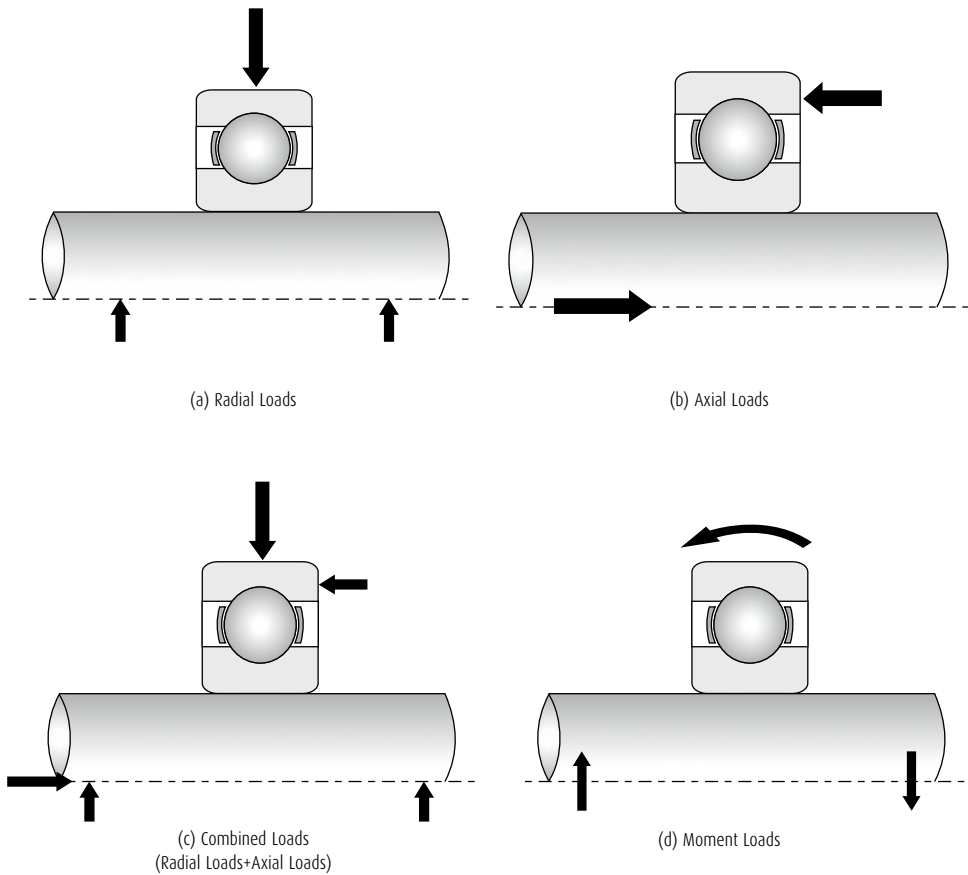
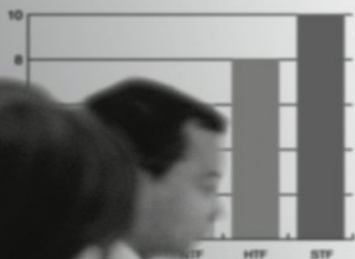

Fig. 1.4 Types of Load

Comparison Between Each Bearing Fatigue Life

NSK



2. SELECTION OF BEARING TYPES

2.1	Bearing Selection Procedure	A 020
2.2	Allowable Bearing Space	A 022
2.3	Load Capacity and Bearing Types	A 022
2.4	Permissible Speed and Bearing Types	A 022
2.5	Misalignment of Inner/Outer Rings and Bearing Types	A 022
2.6	Rigidity and Bearing Types	A 023
2.7	Noise and Torque of Various Bearing Types	A 023
2.8	Running Accuracy and Bearing Types	A 023
2.9	Mounting and Dismounting of Various Bearing Types	A 023

2. Selection of Bearing Types

2.1 Bearing Selection Procedure

The number of applications for rolling bearings is almost countless and the operating conditions and environments also vary greatly. In addition, the diversity of operating conditions and bearing requirements continue to grow with the rapid advancement of technology. Therefore, it is necessary to study bearings carefully from many angles to select the best one from the thousands of types and sizes available.

Usually, a bearing type is provisionally chosen considering the operating conditions, mounting arrangement, ease of mounting in the machine, allowable space, cost, availability, and other factors.

Then the size of the bearing is chosen to satisfy the desired life requirement. When doing this, in addition to fatigue life, it is necessary to consider grease life, noise and vibration, wear, and other factors.

There is no fixed procedure for selecting bearings. It is good practice to investigate experience with similar applications and studies relevant to any special requirements for your specific application. When selecting bearings for new machines, unusual operating conditions, or harsh environments, please consult with NSK.

The following diagram (Fig. 2.1) shows an example of the bearing selection procedure.

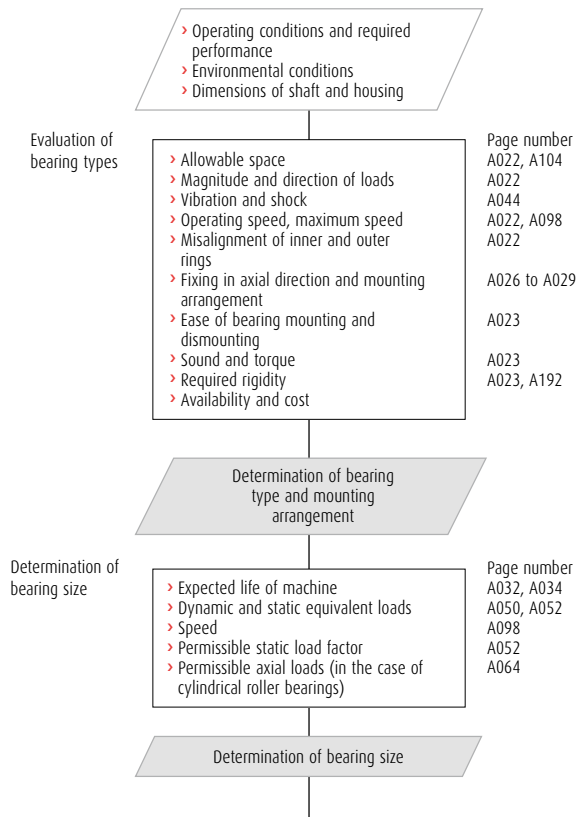
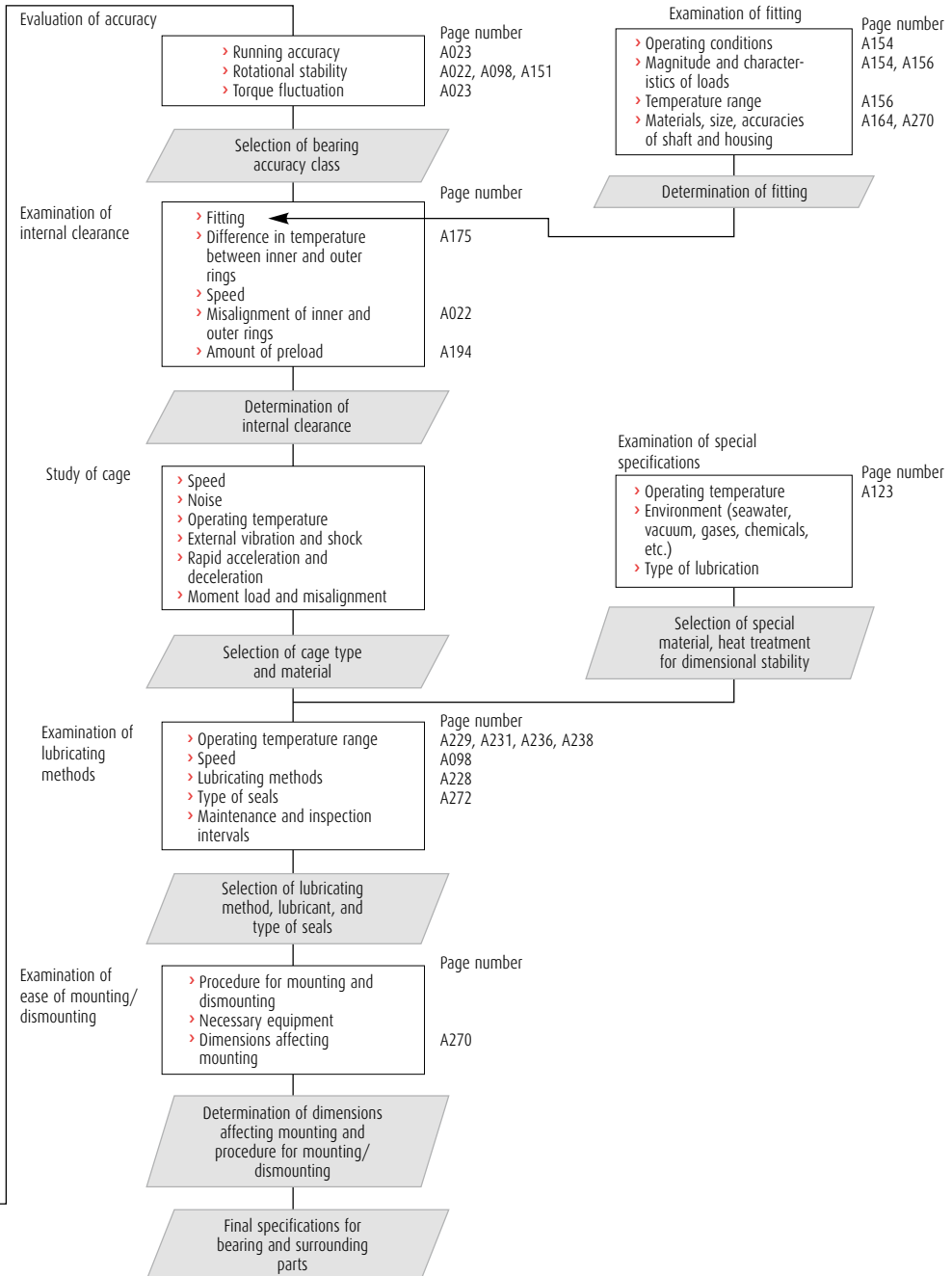

Fig. 2.1 Flow Chart for Selection of Rolling Bearings



Selection of Bearing Types

2.2 Allowable Bearing Space

The allowable space for a rolling bearing and its adjacent parts is generally limited so the type and size of the bearing must be selected within such limits. In most cases, the shaft diameter is fixed first by the machine design; therefore, the bearing is often selected based on its bore size. For rolling bearings, there are numerous standardized dimension series and types, and the selection of the optimum bearing from among them is necessary. Fig. 2.2 shows the dimension series of radial bearings and corresponding bearing types.

2.3 Load Capacity and Bearing Types

The axial load carrying capacity of a bearing is closely related to the radial load capacity (see Page A032) in a manner that depends on the bearing design as shown in Fig. 2.3. This figure makes it clear that when bearings of the same dimension series are compared, roller bearings have a higher load capacity than ball bearings and are superior if shock loads exist.

2.4 Permissible Speed and Bearing Types

The maximum speed of rolling bearings varies depending, not only the type of bearing, but also its size, type of cage, loads, lubricating method, heat dissipation, etc. Assuming the common oil bath lubrication method, the bearing types are roughly ranked from higher speed to lower as shown in Fig. 2.4.

2.5 Misalignment of Inner/Outer Rings and Bearing Types

Because of deflection of a shaft caused by applied loads, dimensional error of the shaft and housing, and mounting errors, the inner and outer rings are slightly misaligned. The permissible misalignment varies depending on the bearing type and operating conditions, but usually it is a small angle less than 0.0012 radian (4').

When a large misalignment is expected, bearings having a self-aligning capability, such as self-aligning ball bearings, spherical roller bearings, and certain bearing units should be selected (Figs. 2.5 and 2.6).

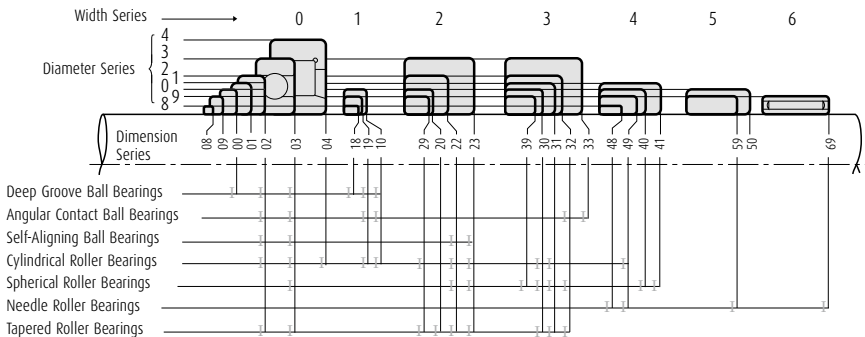

Fig. 2.2 Dimension Series of Radial Bearings

Bearing Type	Radial load capacity				Axial load capacity			
	1	2	3	4	1	2	3	4
Single-Row Deep Groove Ball Bearings	█				█			
Single-Row Angular Contact Ball Bearings	█				█	█		
Cylindrical Roller(*) Bearings	█	█						
Tapered Roller Bearings	█	█			█	█		
Spherical Roller Bearings	█	█			█			

Note(*) The bearings with ribs can take some axial loads.

Fig. 2.3 Relative Load Capacities of Various Bearing Types

Bearing Types	Relative permissible speed				
	1	4	7	10	13
Deep Groove Ball Bearings	█	█	█	█	█
Angular Contact Ball Bearings	█	█	█	█	█
Cylindrical Roller Bearings	█	█	█	█	█
Needle Roller Bearings	█	█	█	█	█
Tapered Roller Bearings	█	█	█	█	█
Spherical Roller Bearings	█	█	█	█	█
Thrust Ball Bearings	█	█	█	█	█

Remarks ——— Oil bath lubrication
 - - - - - With special measures to increase speed limit

Fig. 2.4 Relative Permissible Speeds of Various Bearing Types

Permissible bearing misalignment is given at the beginning of the dimensional tables for each bearing type.

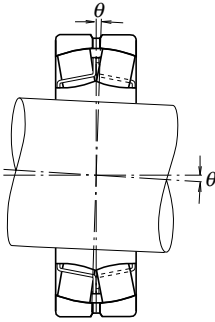

Fig. 2.5 Permissible Misalignment of Spherical Roller Bearings

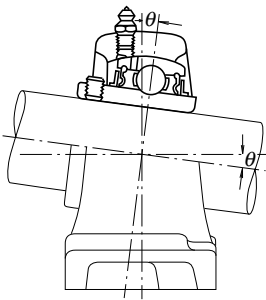

Fig. 2.6 Permissible Misalignment of Ball Bearing Units

2.6 Rigidity and Bearing Types

When loads are imposed on a rolling bearing, some elastic deformation occurs in the contact areas between the rolling elements and raceways. The rigidity of the bearing is determined by the ratio of bearing load to the amount of elastic deformation of the inner and outer rings and rolling elements. For the main spindles of machine tools, it is necessary to have high rigidity of the bearings together with the rest of the spindle. Consequently, since roller bearings are deformed less by load, they are more often selected than ball bearings. When extra high rigidity is required, bearings are given a preload, which means that they have a negative clearance. Angular contact ball bearings and tapered roller bearings are often preloaded.

2.7 Noise and Torque of Various Bearing Types

Since rolling bearings are manufactured with very high precision, noise and torque are minimal. For deep groove ball bearings and cylindrical roller bearings particularly, the noise level is sometimes specified depending on their purpose. For high precision miniature ball bearings, the starting torque is specified. Deep groove ball bearings are recommended for applications in which low noise and torque are required, such as motors and instruments.

2.8 Running Accuracy and Bearing Types

For the main spindles of machine tools that require high running accuracy or high speed applications like superchargers, high precision bearings of Class 5, 4 or 2 are usually used.

The running accuracy of rolling bearings is specified in various ways, and the specified accuracy classes vary depending on the bearing type. A comparison of the inner ring radial runout for the highest running accuracy specified for each bearing type is shown in Fig. 2.7.

For applications requiring high running accuracy, deep groove ball bearings, angular contact ball bearings, and cylindrical roller bearings are most suitable.

2.9 Mounting and Dismounting of Various Bearing Types

Separable types of bearings like cylindrical roller bearings, needle roller bearings and tapered roller bearings are convenient for mounting and dismounting. For machines in which bearings are mounted and dismounted rather often for periodic inspection, these types of bearings are recommended. Also, self-aligning ball bearings and spherical roller bearings (small ones) with tapered bores can be mounted and dismounted relatively easily using sleeves.

Bearing Types	Highest accuracy specified	Tolerance comparison of inner ring radial runout				
		1	2	3	4	5
Deep Groove Ball Bearings	Class 2	→				
Angular Contact Ball Bearings	Class 2	→				
Cylindrical Roller Bearings	Class 2	→				
Tapered Roller Bearings	Class 4	→	→			
Spherical Roller Bearings	Normal	→	→	→	→	→

Fig. 2.7 Relative Inner Ring Radial Runout of Highest Accuracy Class for Various Bearing Types

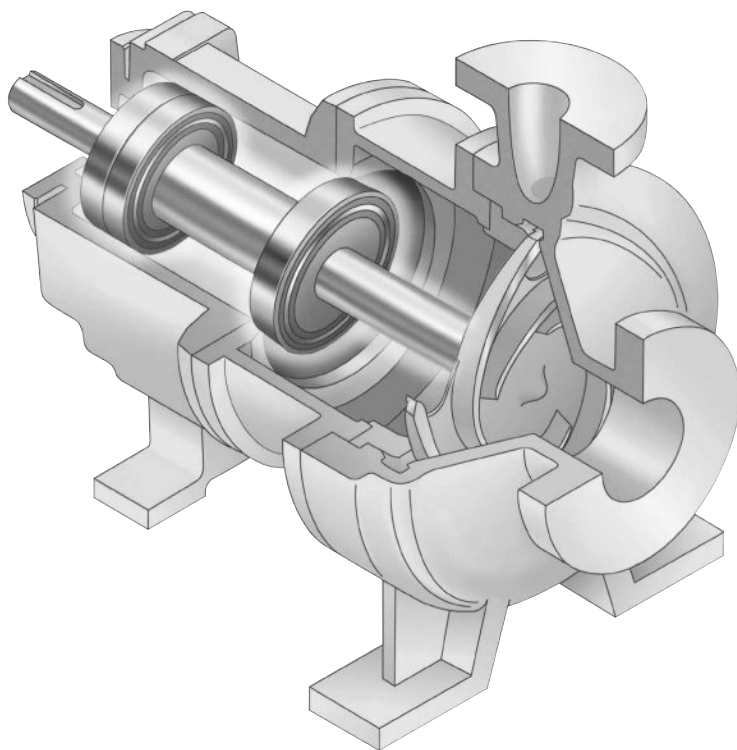

3. SELECTION OF BEARING ARRANGEMENT

3.1 Fixed-End and Free-End Bearings	A 026
3.2 Example of Bearing Arrangements	A 027

3. Selection of Bearing Arrangement

In general, shafts are supported by only two bearings. When considering the bearing mounting arrangement, the following items must be investigated:

- (1) Expansion and contraction of the shaft caused by temperature variations.
- (2) Ease of bearing mounting and dismounting.
- (3) Misalignment of the inner and outer rings caused by deflection of the shaft or mounting error.
- (4) Rigidity of the entire system including bearings and preloading method.
- (5) Capability to sustain the loads at their proper positions and to transmit them.

3.1 Fixed-End and Free-End Bearings

Among the bearings on a shaft, only one can be a "fixed-end" bearing that is used to fix the shaft axially. For this fixed-end bearing, a type which can carry both radial and axial loads must be selected.

Bearings other than the fixed-end one must be "free-end" bearings that carry only radial loads to relieve the shaft's thermal elongation and contraction.

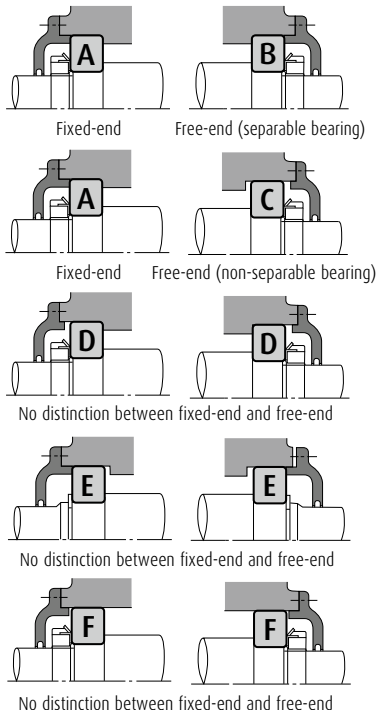

Fig. 3.1 Bearing Mounting Arrangements and Bearing Types

If measures to relieve a shaft's thermal elongation and contraction are insufficient, abnormal axial loads are applied to the bearings, which can cause premature failure.

For free-end bearings, cylindrical roller bearings or needle roller bearings with separable inner and outer rings that are free to move axially (NU, N types, etc.) are recommended. When these types are used, mounting and dismounting are also easier.

When non-separable types are used as free-end bearings, usually the fit between the outer ring and housing is loose to allow axial movement of the running shaft together with the bearing. Sometimes, such elongation is relieved by a loose fitting between the inner ring and shaft.

When the distance between the bearings is short and the influence of the shaft elongation and contraction is negligible, two opposed angular contact ball bearings or tapered roller bearings are used. The axial clearance (possible axial movement) after the mounting is adjusted using nuts or shims.

BEARING A

- > Deep Groove Ball Bearing
- > Matched Angular Contact Ball Bearing
- > Double-Row Angular Contact Ball Bearing
- > Self-Aligning Ball Bearing
- > Cylindrical Roller Bearing with Ribs (NH, NUP types)
- > Double-Row Tapered Roller Bearing
- > Spherical Roller Bearing

BEARING B

- > Cylindrical Roller Bearing (NU, N types)
- > Needle Roller Bearing (NA type, etc.)

BEARING C(1)

- > Deep Groove Ball Bearing
- > Matched Angular Contact Ball Bearing (back-to-back)
- > Double-Row Angular Contact Ball Bearing
- > Self-Aligning Ball Bearing
- > Double-Row Tapered Roller Bearing (KBE type)
- > Spherical Roller Bearing

BEARING D,E(2)

- > Angular Contact Ball Bearing
- > Tapered Roller Bearing
- > Magneto Bearing
- > Cylindrical Roller Bearing (NJ, NF types)

BEARING F

- > Deep Groove Ball Bearing
- > Self-Aligning Ball Bearing
- > Spherical Roller Bearing

- Notes**
- (1) In the figure, shaft elongation and contraction are relieved at the outside surface of the outer ring, but sometimes it is done at the bore.
 - (2) For each type, two bearings are used in opposition.

The distinction between free-end and fixed-end bearings and some possible bearing mounting arrangements for various bearing types are shown in Fig. 3.1.

3.2 Examples of Bearing Arrangements

Some representative bearing mounting arrangements considering preload and rigidity of the entire assembly, shaft elongation and contraction, mounting error, etc. are shown in Table 3.1.

Table 3.1 Representative Bearing Mounting Arrangements and Application Examples

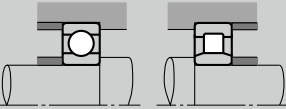
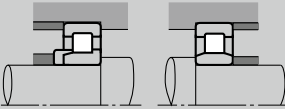
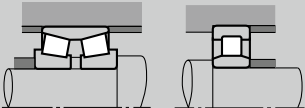
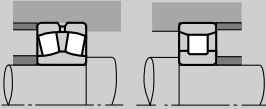
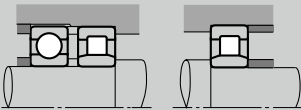
Bearing Arrangements		Remarks	Application Examples
Fixed-end	Free-end		
		<ul style="list-style-type: none"> > This is a common arrangement in which abnormal loads are not applied to bearings even if the shaft expands or contracts. > The mounting error is small, this is suitable for high speeds. 	Medium size electric motors, blowers
		<ul style="list-style-type: none"> > This can withstand heavy loads and shock loads and can take some axial load. > Every type of cylindrical roller bearing is separable. This is helpful when interference is necessary for both the inner and outer rings. 	Traction motors for rolling stock
		<ul style="list-style-type: none"> > This is used when loads are relatively heavy. > For maximum rigidity of the fixed-end bearing, it is a back-to-back type. > Both the shaft and housing must have high accuracy and the mounting error must be small. 	Table rollers for steel mills, main spindles of lathes
		<ul style="list-style-type: none"> > This is also suitable when interference is necessary for both the inner and outer rings. Heavy axial loads cannot be applied. 	Calender rolls of paper making machines, axles of diesel locomotives
		<ul style="list-style-type: none"> > This is suitable for high speeds and heavy radial loads. Moderate axial loads can also be applied. > It is necessary to provide some clearance between the outer ring of the deep groove ball bearing and the housing bore in order to avoid subjecting it to radial loads. 	Reduction gears in diesel locomotives

Continued on next page

Selection of Bearing Arrangement

Table 3.1 Representative Bearing Mounting Arrangements and Application Examples

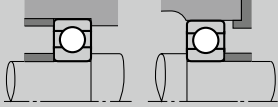
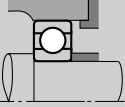
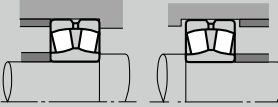
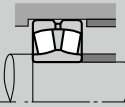
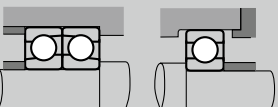
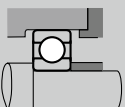
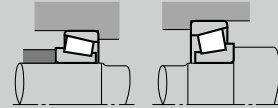
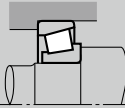
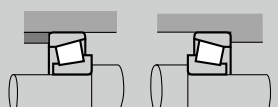
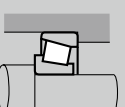
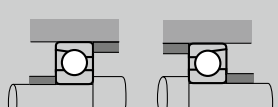
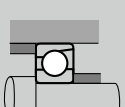
Bearing Arrangements		Remarks	Application Examples
Fixed-end	Free-end		
		<ul style="list-style-type: none"> > This is the most common arrangement. > It can sustain not only radial loads, but moderate axial loads also. 	Double suction volute pumps, automotive transmissions
		<ul style="list-style-type: none"> > This is the most suitable arrangement when there is mounting error or shaft deflection. > It is often used for general and industrial applications in which heavy loads are applied. 	Speed reducers, table rollers of steel mills, wheels for overhead travelling cranes
		<ul style="list-style-type: none"> > This is suitable when there are rather heavy axial loads in both directions. > Double row angular contact bearings may be used instead of an arrangement of two angular contact ball bearings. 	Worm gear reducers
When there is no distinction between fixed-end and free-end		Remarks	Application Examples
		<p style="text-align: center;">Back-to-back mounting</p> <ul style="list-style-type: none"> > This arrangement is widely used since it can withstand heavy loads and shock loads. > The back-to-back arrangement is especially good when the distance between bearings is short and moment loads are applied. > Face-to-face mounting makes mounting easier when interference is necessary for the inner ring. In general, this arrangement is good when there is mounting error. > To use this arrangement with a preload, attention must be paid to the amount of preload and clearance adjustment. 	Pinion shafts of automotive differential gears, automotive front and rear axles, worm gear reducers
		<p style="text-align: center;">Face-to-face mounting</p>	
		<p style="text-align: center;">Back-to-back mounting</p> <ul style="list-style-type: none"> > This is used at high speeds when radial loads are not so heavy and axial loads are relatively heavy. > It provides good rigidity of the shaft by preloading. > For moment loads, back-to-back mounting is better than face-to-face mounting. 	Grinding wheel shafts

Continued on next page

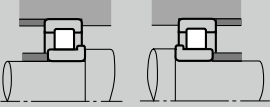
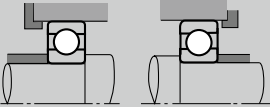
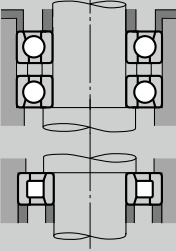
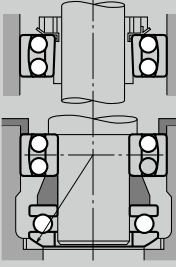
When there is no distinction between fixed-end and free-end	Remarks	Application Examples
 <p data-bbox="174 432 298 453">NJ + NJ mounting</p>	<ul style="list-style-type: none"> <li data-bbox="421 300 762 320">› This can withstand heavy loads and shock loads. <li data-bbox="421 328 777 371">› It can be used if interference is necessary for both the inner and outer rings. <li data-bbox="421 379 773 422">› Care must be taken so the axial clearance doesn't become too small during running. <li data-bbox="421 430 738 451">› NF type + NF type mounting is also possible. 	<p data-bbox="817 288 977 331">Final reduction gears of construction machines</p>
	<ul style="list-style-type: none"> <li data-bbox="421 513 785 557">› Sometimes a spring is used at the side of the outer ring of one bearing. 	<p data-bbox="817 513 1012 557">Small electric motors, small speed reducers, small pumps</p>
Vertical arrangements	Remarks	Application Examples
	<ul style="list-style-type: none"> <li data-bbox="421 794 765 837">› Matched angular contact ball bearings are on the fixed end. <li data-bbox="421 845 730 866">› Cylindrical roller bearing is on the free end. 	<p data-bbox="817 794 971 815">Vertical electric motors</p>
	<ul style="list-style-type: none"> <li data-bbox="421 1155 777 1198">› The spherical center of the self-aligning seat must coincide with that of the self-aligning ball bearing. <li data-bbox="421 1206 689 1227">› The upper bearing is on the free end. 	<p data-bbox="817 1155 1020 1198">Vertical openers (spinning and weaving machines)</p>

4. SELECTION OF BEARING SIZE

4.1	Bearing Life	A 032
4.1.1	Rolling Fatigue Life and Basic Rating Life	A 032
4.2	Basic Load Rating and Fatigue Life	A 032
4.2.1	Basic Load Rating	A 032
4.2.2	Machinery in which Bearings are Used and Projected Life	A 034
4.2.3	Selection of Bearing Size Based on Basic Load Rating	A 035
4.2.4	Temperature Adjustment for Basic Load Rating	A 035
4.2.5	Correction of Basic Rating Life	A 037
4.2.6	Life Calculation of Multiple Bearings as a Group	A 038
4.2.7	New Life Theory	A 040
4.3	Calculation of Bearing Loads	A 044
4.3.1	Load Factor	A 044
4.3.2	Bearing Loads in Belt or Chain Transmission Applications	A 044
4.3.3	Bearing Loads in Gear Transmission Applications	A 045
4.3.4	Load Distribution on Bearings	A 045
4.3.5	Average of Fluctuating Load	A 046
4.3.6	Combination of Rotating and Stationary Loads	A 048
4.4	Equivalent Load	A 050
4.4.1	Calculation of Equivalent Loads	A 050
4.4.2	Axial Load Components in Angular Contact Ball Bearings and Tapered Roller Bearings	A 051
4.5	Static Load Ratings and Static Equivalent Loads	A 052
4.5.1	Static Load Ratings	A 052
4.5.2	Static Equivalent Loads	A 052
4.5.3	Permissible Static Load Factor	A 052

4.6	Examples of Bearing Calculations	A 054
4.7	Bearing Type and Allowable Axial Load	A 058
4.7.1	Change of Contact Angle of Radial Ball Bearings and Allowable Axial Load	A 058
(1)	Change of Contact Angle Due to Axial Load	A 058
(2)	Allowable Axial Load for a Deep Groove Ball Bearing	A 062
4.7.2	Allowable Axial Load (Break Down Strength of The Ribs) for a Cylindrical Roller Bearings	A 064
4.8	Technical Data	A 066
4.8.1	Fatigue Life and Reliability	A 066
4.8.2	Radial Clearance and Fatigue Life	A 068
4.8.3	Misalignment of Inner/Outer Rings and Fatigue Life of Deep Groove Ball Bearings	A 070
4.8.4	Misalignment of Inner/Outer Rings and Fatigue Life of Cylindrical Roller Bearings	A 072
4.8.5	Oil Film Parameters and Rolling Fatigue Life	A 074
4.8.6	EHL Oil Film Parameter Calculation Diagram	A 076
(1)	Oil Film Parameter	A 076
(2)	Oil Film Parameter Calculation Diagram	A 076
(3)	Effect of Oil Shortage and Shearing Heat Generation	A 080
4.8.7	Load Calculation of Gears	A 082
(1)	Calculation of Loads on Spur, Helical, and Double-Helical Gears	A 082
(2)	Calculation of Load Acting on Straight Bevel Gears	A 086
(3)	Calculation of Load on Spiral Bevel Gears	A 088
(4)	Calculation of Load Acting on Hypoid Gears	A 090
(5)	Calculation of Load on Worm Gear	A 094

4. Selection of Bearing Size

4.1 Bearing Life

The various functions required of rolling bearings vary according to the bearing application. These functions must be performed for a prolonged period. Even if bearings are properly mounted and correctly operated, they will eventually fail to perform satisfactorily due to an increase in noise and vibration, loss of running accuracy, deterioration of grease, or fatigue flaking of the rolling surfaces.

Bearing life, in the broad sense of the term, is the period during which bearings continue to operate and to satisfy their required functions. This bearing life may be defined as noise life, abrasion life, grease life, or rolling fatigue life, depending on which one causes loss of bearing service.

Aside from the failure of bearings to function due to natural deterioration, bearings may fail when conditions such as heat-seizure, fracture, scoring of the rings, damage of the seals or the cage, or other damage occurs.

Conditions such as these should not be interpreted as normal bearing failure since they often occur as a result of errors in bearing selection, improper design or manufacture of the bearing surroundings, incorrect mounting, or insufficient maintenance.

4.1.1 Rolling Fatigue Life and Basic Rating Life

When rolling bearings are operated under load, the raceways of their inner and outer rings and rolling elements are subjected to repeated cyclic stress. Because of metal fatigue of the rolling contact surfaces of the raceways and rolling elements, scaly particles may separate from the bearing material (Fig. 4.1).

This phenomenon is called "flaking". Rolling fatigue life is represented by the total number of revolutions at which time the bearing surface will start flaking due to stress. This is called fatigue life. As shown in Fig. 4.2, even for seemingly identical bearings, which are of the same type, size, and material and receive the same heat treatment and other processing, the rolling fatigue life varies greatly even under identical operating conditions. This is because the flaking of materials due to fatigue is subject to many other variables. Consequently, "basic rating life", in which rolling fatigue life is treated as a statistical phenomenon, is used in preference to actual rolling fatigue life.

Suppose a number of bearings of the same type are operated individually under the same conditions. After a certain period of time, 10 % of them fail as a result of flaking caused by rolling fatigue. The total number of revolutions at this point is defined as the basic rating life or, if the speed is constant, the basic rating life is often expressed by the total number of operating hours completed when 10 % of the bearings become inoperable due to flaking.

In determining bearing life, basic rating life is often the only factor considered. However, other factors must also be taken into account. For example, the grease life of grease-prelubricated bearings (refer to Section 11, Lubrication, Page A228) can be estimated. Since noise life and abrasion life are judged according to individual standards for different applications, specific values for noise or abrasion life must be determined empirically.

4.2 Basic Load Rating and Fatigue Life

4.2.1 Basic Load Rating

The basic load rating is defined as the constant load applied on bearings with stationary outer rings that the inner rings can endure for a rating life of one million revolutions (10^6 rev). The basic load rating of radial bearings is defined as a central radial load of constant direction and magnitude, while the basic load rating of thrust bearings is defined as an axial load of constant magnitude in the same direction as the central axis. The load ratings are listed under C_r for radial bearings and C_a for thrust bearings in the dimension tables.



Fig. 4.1 Example of Flaking

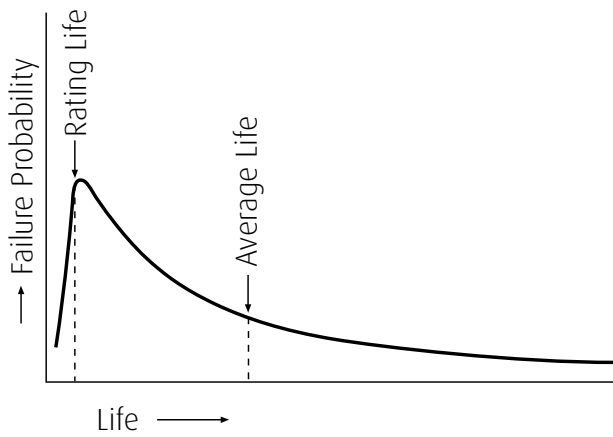

Fig. 4.2 Failure Probability and Bearing Life

Selection of Bearing Size

4.2.2 Machinery in which Bearings are Used and Projected Life

It is not advisable to select bearings with unnecessarily high load ratings, for such bearings may be too large and uneconomical. In addition, the bearing life alone should not be the deciding factor in the selection of bearings. The strength, rigidity, and design of the shaft on which the bearings are to be mounted should also be considered. Bearings are used in a wide range of applications and the design life varies with specific applications and operating conditions. Table 4.1 gives an empirical fatigue life factor derived from customary operating experience for various machines. Also refer to Table 4.2.

Table 4.1 Fatigue Life Factor f_h for Various Bearing Applications

Operating Periods	Fatigue Life Factor f_h				
	~3	2~4	3~5	4~7	6~
Infrequently used or only for short periods	<ul style="list-style-type: none"> > Small motors for home appliances like vacuum cleaners and washing machines > Hand power tools 	<ul style="list-style-type: none"> > Agricultural equipment 			
Used only occasionally but reliability is important		<ul style="list-style-type: none"> > Motors for home heaters and air conditioners > Construction equipment 	<ul style="list-style-type: none"> > Conveyors > Elevator cable sheaves 		
Used intermittently for relatively long periods	<ul style="list-style-type: none"> > Rolling mill roll necks 	<ul style="list-style-type: none"> > Small motors > Deck cranes > General cargo cranes > Pinion stands > Passenger cars 	<ul style="list-style-type: none"> > Factory motors > Machine tools > Transmissions > Vibrating screens > Crushers 	<ul style="list-style-type: none"> > Crane sheaves > Compressors > Specialized transmissions 	
Used intermittently for more than eight hours daily		<ul style="list-style-type: none"> > Escalators 	<ul style="list-style-type: none"> > Centrifugal separators > Air conditioning equipment > Blowers > Woodworking machines > Large motors > Axle boxes on railway rolling stock 	<ul style="list-style-type: none"> > Mine hoists > Press flywheels > Railway traction motors > Locomotive axle boxes 	<ul style="list-style-type: none"> > Paper making machines
Used continuously and high reliability is important					<ul style="list-style-type: none"> > Waterworks pumps > Electric power stations > Mine draining pumps

Table 4.2 Basic Rating Life, Fatigue Life Factor and Speed Factor

Life Parameters	Ball Bearings	Roller Bearings
Basic Rating Life	$L_h = \frac{10^6}{60n} \left(\frac{C}{P}\right)^3 = 500 f_h^3$	$L_h = \frac{10^6}{60n} \left(\frac{C}{P}\right)^{10} = 500 f_h^{\frac{10}{3}}$
Fatigue Life Factor	$f_h = f_n \frac{C}{P}$	$f_h = f_n \frac{C}{P}$
Speed Factor	$f_n = \left(\frac{10^6}{500 \times 60n}\right)^{\frac{1}{3}}$ $= (0.03n)^{-\frac{1}{3}}$	$f_n = \left(\frac{10^6}{500 \times 60n}\right)^{\frac{3}{10}}$ $= (0.03n)^{-\frac{3}{10}}$

$n, f_n \dots$ Fig. 4.3 (See Page A036), Appendix Table 12 (See Page C018)

$L_h, f_h \dots$ Fig. 4.4 (See Page A036), Appendix Table 13 (See Page C019)

4.2.3 Selection of Bearing Size Based on Basic Load Rating

The following relation exists between bearing load and basic rating life:

$$\text{For ball bearings } L = \left(\frac{C}{P}\right)^3 \dots\dots\dots (4.1)$$

$$\text{For roller bearings } L = \left(\frac{C}{P}\right)^{\frac{10}{3}} \dots\dots\dots (4.2)$$

- where L : Basic rating life (10⁶ rev)
 P : Bearing load (equivalent load) (N), {kgf}
(Refer to Page A030)
 C : Basic load rating (N), {kgf}
 For radial bearings, C is written C_r
 For thrust bearings, C is written C_a

In the case of bearings that run at a constant speed, it is convenient to express the fatigue life in terms of hours. In general, the fatigue life of bearings used in automobiles and other vehicles is given in terms of kilometer.

By designating the basic rating life as L_h (h), bearing speed as n (min⁻¹), fatigue life factor as f_h, and speed factor as f_n, the relations shown in Table 4.2 are obtained.

If the bearing load P and speed n are known, determine a fatigue life factor f_h appropriate for the projected life of the machine and then calculate the basic load rating C by means of the following equation.

$$C = \frac{f_h \cdot P}{f_n} \dots\dots\dots (4.3)$$

A bearing which satisfies this value of C should then be selected from the bearing tables.

4.2.4 Temperature Adjustment for Basic Load Rating

If rolling bearings are used at high temperature, the hardness of the bearing steel decreases. Consequently, the basic load rating, which depends on the physical properties of the material, also decreases. Therefore, the basic load rating should be adjusted for the higher temperature using the following equation:

$$C_t = f_t \cdot C \dots\dots\dots (4.4)$$

- where C_t : Basic load rating after temperature correction (N), {kgf}
 f_t : Temperature factor
 (See Table 4.3)
 C : Basic load rating before temperature adjustment (N), {kgf}

If large bearings are used at higher than 120 °C, they must be given special dimensional stability heat treatment to prevent excessive dimensional changes. The basic load rating of bearings given such special dimensional stability heat treatment may become lower than the basic load rating listed in the bearing tables.

Table 4.3 Temperature Factor f_t

Bearing Temperature °C	125	150	175	200	250
Temperature Factor f _t	1.00	1.00	0.95	0.90	0.75

Selection of Bearing Size

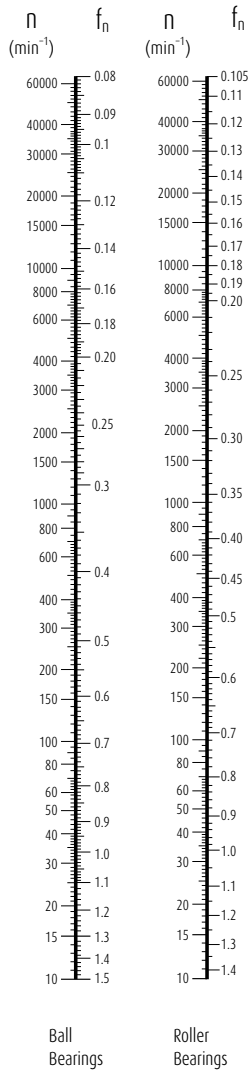

Fig. 4.3 Bearing Speed and Speed Factor

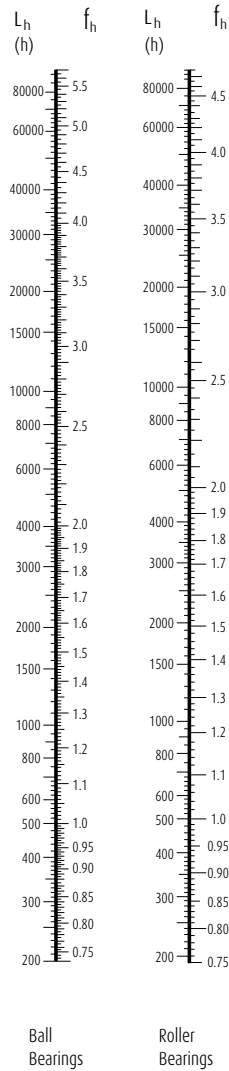

Fig. 4.4 Fatigue Life Factor and Fatigue Life

4.2.5 Correction of Basic Rating Life

As described previously, the basic equations for calculating the basic rating life are as follows:

$$\text{For ball bearings } L_{10} = \left(\frac{C}{P}\right)^3 \dots\dots\dots (4.5)$$

$$\text{For roller bearings } L_{10} = \left(\frac{C}{P}\right)^{\frac{10}{3}} \dots\dots\dots (4.6)$$

The L_{10} life is defined as the basic rating life with a statistical reliability of 90%. Depending on the machines in which the bearings are used, sometimes a reliability higher than 90% may be required. However, recent improvements in bearing material have greatly extended the fatigue life. In addition, the development of the Elasto-Hydrodynamic Theory of Lubrication proves that the thickness of the lubricating film in the contact zone between rings and rolling elements greatly influences bearing life. To reflect such improvements in the calculation of fatigue life, the basic rating life is adjusted using the following adjustment factors:

$$L_{na} = a_1 a_2 a_3 L_{10} \dots\dots\dots (4.7)$$

where L_{na} : Adjusted rating life in which reliability, material improvements, lubricating conditions, etc. are considered

L_{10} : Basic rating life with a reliability of 90%

a_1 : Life adjustment factor for reliability

a_2 : Life adjustment factor for special bearing properties

a_3 : Life adjustment factor for operating conditions

The life adjustment factor for reliability, a_1 , is listed in Table 4.4 for reliabilities higher than 90%.

The life adjustment factor for special bearing properties, a_2 , is used to reflect improvements in bearing steel.

NSK now uses vacuum degassed bearing steel, and the results of tests by NSK show that life is greatly improved when compared with earlier materials. The basic load ratings C_r and C_a listed in the bearing tables were calculated considering the extended life achieved by improvements in materials and manufacturing techniques. Consequently, when estimating life using Equation (4.7), it is sufficient to assume that is greater than one.

The life adjustment factor for operating conditions a_3 is used to adjust for various factors, particularly lubrication. If there is no misalignment between the inner and outer rings and the thickness of the lubricating film in the contact zones of the bearing is sufficient, it is possible for a_3 to be greater than one; however, a_3 is less than one in the following cases:

- > When the viscosity of the lubricant in the contact zones between the raceways and rolling elements is low.
- > When the circumferential speed of the rolling elements is very slow.
- > When the bearing temperature is high.
- > When the lubricant is contaminated by water or foreign matter.
- > When misalignment of the inner and outer rings is excessive.

It is difficult to determine the proper value for a_3 for specific operating conditions because there are still many unknowns. Since the special bearing property factor a_2 is also influenced by the operating conditions, there is a proposal to combine a_2 and a_3 into one quantity ($a_2 \times a_3$), and not consider them independently. In this case, under normal lubricating and operating conditions, the product ($a_2 \times a_3$) should be assumed equal to one. However, if the viscosity of the lubricant is too low, the value drops to as low as 0.2.

If there is no misalignment and a lubricant with high viscosity is used so sufficient fluid-film thickness is secured, the product of ($a_2 \times a_3$) may be about two.

When selecting a bearing based on the basic load rating, it is best to choose an a_1 reliability factor appropriate for the projected use and an empirically determined C/P or f_1 value derived from past results for lubrication, temperature, mounting conditions, etc. in similar machines.

The basic rating life equations (4.1), (4.2), (4.5), and (4.6) give satisfactory results for a broad range of bearing loads. However, extra heavy loads may cause detrimental plastic deformation at ball/raceway contact points. When P_r exceeds C_{or} (Basic static load rating) or $0.5 C_r$, whichever is smaller, for radial bearings or P_a exceeds $0.5 C_a$ for thrust bearings, please consult NSK to establish the applicability of the rating fatigue life equations.

Table 4.4 Reliability Factor a_1

Reliability (%)	90	95	96	97	98	99
a_1	1.00	0.62	0.53	0.44	0.33	0.21

Selection of Bearing Size

4.2.6 Life Calculation of Multiple Bearings as a Group

When multiple rolling bearings are used in one machine, the fatigue life of individual bearings can be determined if the load acting on individual bearings is known. Generally, however, the machine becomes inoperative if a bearing in any part fails. It may therefore be necessary in certain cases to know the fatigue life of a group of bearings used in one machine. The fatigue life of the bearings varies greatly and our fatigue life calculation equation

$L = \left(\frac{C}{P}\right)^p$ applies to the 90% life (also called

the rating fatigue life, which is either the gross number of revolution or hours to which 90% of multiple similar bearings operated under similar conditions can reach). In other words, the calculated fatigue life for one bearing has a probability of 90%. Since the endurance probability of a group of multiple bearings for a certain period is a product of the endurance probability of individual bearings for the same period, the rating fatigue life of a group of multiple bearings is not determined solely from the shortest rating fatigue life among the individual bearings. In fact, the group life is much shorter than the life of the bearing with the shortest fatigue life. Assuming the rating fatigue life of individual bearings as $L_1, L_2, L_3 \dots$ and the rating fatigue life of the entire group of bearings as L , the below equation is obtained:

$$\frac{1}{L^e} = \frac{1}{L_1^e} + \frac{1}{L_2^e} + \frac{1}{L_3^e} + \dots \quad (4.8)$$

where, $e=1.1$ (both for ball and roller bearings)

L of Equation (4.8) can be determined with ease by using Fig. 4.5.

Take the value L_1 of Equation (4.8) on the L_1 scale and the value of L_2 on the L_2 scale, connect them with a straight line, and read the intersection with the L scale. In this way, the value L_A of

$$\frac{1}{L_A^e} = \frac{1}{L_1^e} + \frac{1}{L_2^e}$$

is determined. Take this value L_A on the L_1 scale and the value L_3 on the L_2 scale, connect them with a straight line, and read an intersection with the L scale.

In this way, the value L of

$$\frac{1}{L^e} = \frac{1}{L_1^e} + \frac{1}{L_2^e} + \frac{1}{L_3^e}$$

can be determined.

Example

Assume that the calculated fatigue life of bearings of automotive front wheels as follows:

280 000 km for inner bearing

320 000 km for outer bearing

Then, the fatigue life of bearings of the wheel can be determined at 160 000 km from Fig. 4.5.

If the fatigue life of the bearing of the right-hand wheel takes this value, the fatigue life of the left-hand wheel will be the same. As a result, the fatigue life of the front wheels as a group will become 85 000 km.

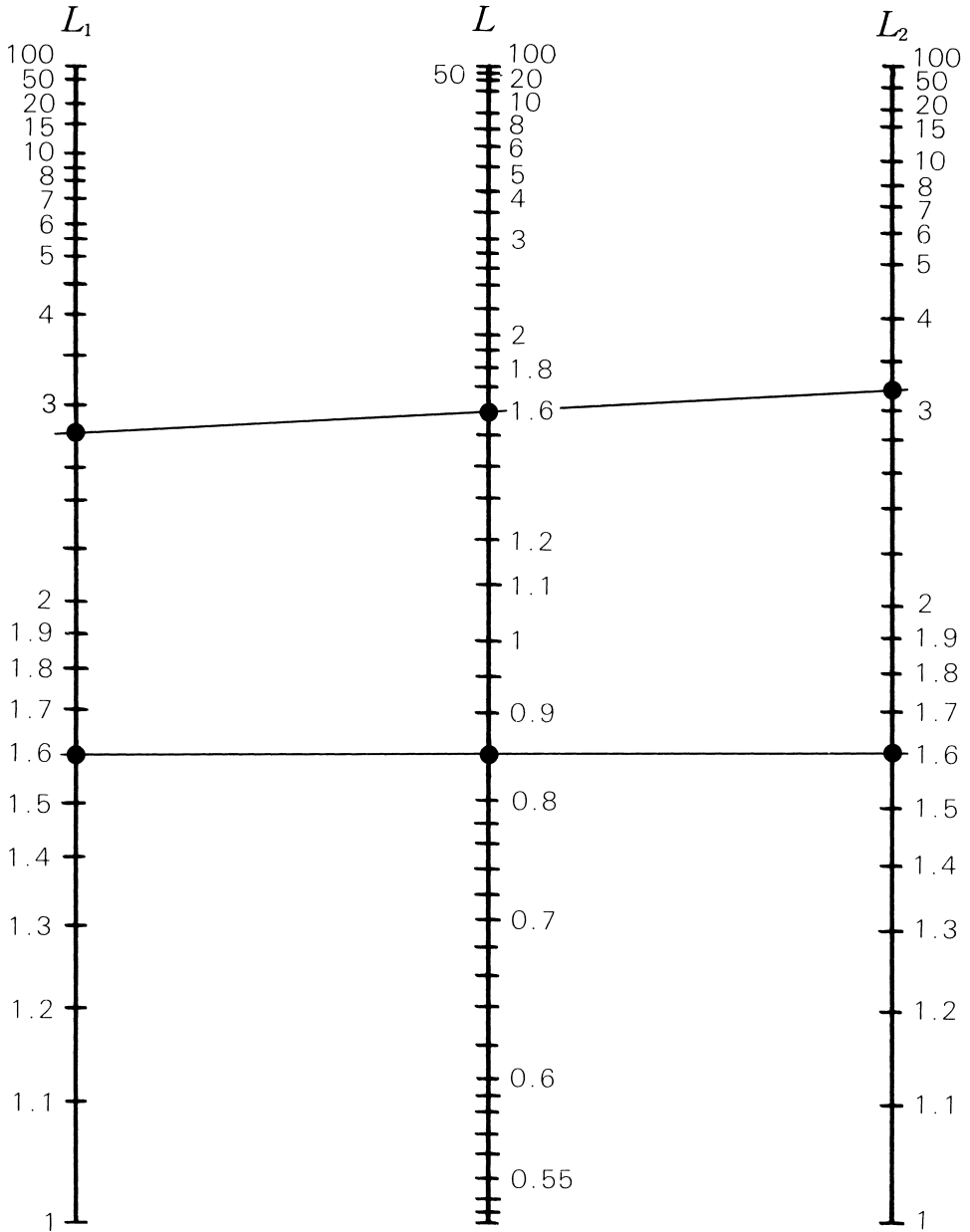

Fig. 4.5 Chart for Life Calculation

Selection of Bearing Size

4.2.7 New Life Theory

Bearing technology has advanced rapidly in recent years, particularly in the areas of dimensional accuracy and material cleanliness. As a result, bearings can now have a longer rolling fatigue life in a cleaner environment, than the life obtained by the traditional ISO life calculation formula. This extended life is partly due to the important advancements in bearing related technology such as lubrication cleanliness and filtration.

The conventional life calculation formula, based on the theories of G. Lundberg and A. Palmgren (L-P theory, hereafter) addresses only sub-surface originated flaking. This is the phenomenon in which cracks initially occur due to dynamic shear stress immediately below the rolling surface then progressively reach the surface in the form of flaking.

$$\ln \frac{1}{S} \propto \frac{\tau_0^c N^e V}{Z_0^h} \dots \dots \dots (4.9)$$

NSK's new life calculation formula theorizes that rolling fatigue life is the sum total of the combined effects of both sub-surface originated flaking and surface originated flaking occurring simultaneously.

NSK New Life Calculation Formula

(1) Sub-surface originated flaking

A pre-condition of sub-surface originated flaking of rolling bearings is contact of the rolling elements with the raceway via a sufficient and continuous oil film under clean lubrication conditions.

Fig. 4.6 plots the L_{10} life for each test condition with maximum surface contact pressure (P_{max}) and the number of repeated stresses applied on the ordinate and the abscissa, respectively.

In the figure, line L_{10} theoretical is the theoretical line obtained using the conventional life calculation formula.

As maximum surface contact pressure decreases, the actual life line separates from the line created by using conventional theoretical calculation and moves towards longer life.

This separation suggests the presence of fatigue load limit P_u below which no rolling fatigue occurs. This is better illustrated in Fig. 4.7.

$$\ln \frac{1}{S} \propto N^e \int_v \frac{(\tau - \tau_u)^c}{Z_0^h} dv \dots \dots \dots (4.10)$$

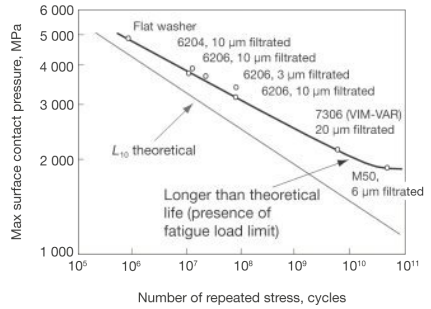

Fig. 4.6 Life Test Result under Clean Lubrication Condition

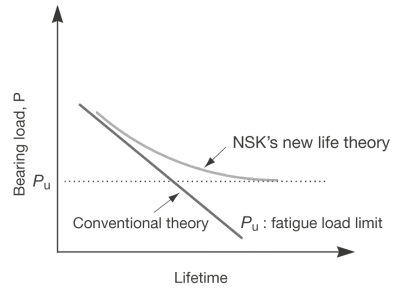

Fig. 4.7 NSK's New Life Theory That Considers Fatigue Limit

(2) Surface originated flaking

Under actual bearing operation, the lubricant is often contaminated with foreign objects such as metal chips, burrs, cast sand, etc.

When the foreign particles are mixed in the lubricant, the particles are pressed onto the raceways by the rolling elements and dents occur on the surfaces of the raceways and rolling elements. Stress concentration occurs at the edges of the dents, generating fine cracks, which over time, propagate into flaking of the raceways and rolling elements. As shown in Fig. 4.8, the actual life is shorter than conventional calculated life, under conditions of contaminated lubrication at low max surface pressure. The actual life line separates from the line created by theoretical life calculations and moves towards a shorter life. This result shows that the actual life under contaminated lubrication is further shortened compared to the theoretical life because of the decrease in maximum surface contact pressure.

Table 4.5 Value of Contamination Coefficient a_c

	Very clean	Clean	Normal	Contaminated	Heavily contaminated
a_c factor	1	0.8	0.5	0.4-0.1	0.05
Application guide	10 μm filtration	10-30 μm filtration	30-100 μm filtration	Greater than 100 μm filtration or no filtration (oil bath, circulating lubrication, etc.)	No filtration, presence of many fine particles
Application examples	Sealed grease lubricated bearing for electrical appliances and information technology equipment, etc.	Sealed grease lubricated bearing for electric motors Sealed grease bearing for railway axle boxes and machine tools, etc.	Normal usage Automotive hub unit bearing, etc.	Bearing for automotive transmission; Bearing for industrial gearbox; Bearing for construction machine, etc.	—

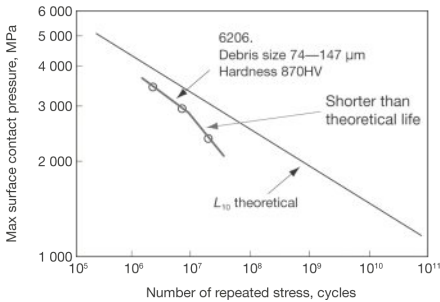

Fig. 4.8 Life Test Result under Contaminated Lubrication Condition

(3) Calculation of Contamination Coefficient a_c

The contamination coefficient in terms of lubrication cleanliness is shown in Table 4.5. Test results on ball and roller bearings with grease lubrication and clean filtration show the life as being a number of times longer than that of the contaminated calculation. Yet when the foreign object is harder than Hv350, hardness becomes a factor and a dent appears on the raceway. Fatigue damage from these dents, can progress to flaking in a short time. Test results on ball and roller bearings under conditions of foreign object contamination show from 1/3 to 1/10 the life when compared with conventionally calculated life. Based on these test results, the contamination coefficient a_c is classified into five steps for NSK's new life theory.

Therefore, the NSK new life calculation formula considers the trend in the results of the life test under conditions of clean environment and at low load zone. Based on these results, the new life equation is a function of $(P-P_u)/C$, which is affected by specific lubrication conditions identified by the lubrication parameter. Also, it is assumed that effects of different types and shapes of foreign particles are strongly influenced by the bearing load and lubrication conditions present, and that such a relationship can be expressed as a function of the load parameter. This relationship of the new life calculation formula is defined by $(P-P_u)/C \cdot 1/a_c$. Calculation formula for surface originated flaking, based on the above concept, is as follows:

$$\ln \frac{1}{S} \propto N^e \int_V \frac{(\tau - \tau_u)^c}{Z_0^h} dV \times \left\{ \frac{1}{f(a_c, a_t)} - 1 \right\} \dots \dots \dots (4.11)$$

Selection of Bearing Size

(4) New life calculation formula L_{able}

The following formula, which combines sub-surface originated flaking and surface originated flaking, is proposed as the new life calculation formula.

$$\ln \frac{1}{S} \propto N \int_V \frac{(\tau - \tau_u)^c}{Z_0^h} dV \times \left\{ \frac{1}{f(a_c, a_l)} - 1 \right\} \dots \dots \dots (4.12)$$

$$L_{\text{able}} = a_1 \cdot a_{\text{NSK}} \cdot L_{10} \dots \dots \dots (4.13)$$

Life Correction Factor a_{NSK}

The life correction factor a_{NSK} is the function of lubrication parameter $(P - P_u) / C \cdot 1 / a_c$ as shown below:

$$a_{\text{NSK}} \propto F \left[\frac{P - P_u}{C} \cdot \frac{1}{a_c} \right] \dots \dots \dots (4.14)$$

NSK's new life theory considers the life extending affect of improved material and heat treatment by correcting the contamination factor a_c . The theory also utilizes viscosity ratio κ ($\kappa = \nu / \nu_1$ where ν is the operational viscosity and ν_1 the required viscosity) because the lubrication parameter a_l changes with the degree of oil film formation, based on the lubricant and operating temperature. The theory indicates that the better the lubrication conditions (higher κ) the longer the life.

Figures 4.9 and 4.10 show the diagrams of the correction factor a_{NSK} as a function of the new life calculation formula. Also in this new life calculation formula, point contact and line contact are considered separately for ball and roller bearings respectively.

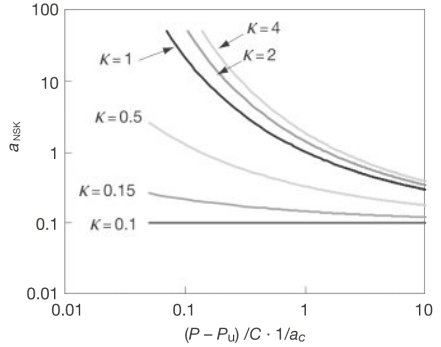

Fig. 4.9 New Life Calculation Diagram for Ball Bearings

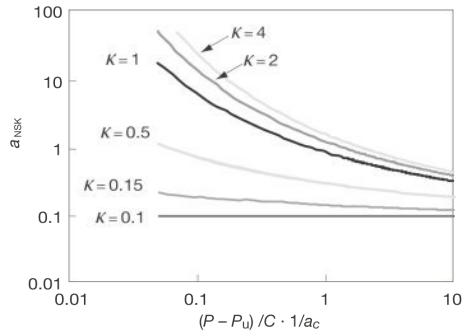

Fig. 4.10 New Life Calculation Diagram for Roller Bearings

To Access the NSK Calculation Tools

Visit our website at <http://www.nsk.com>



Selection of Bearing Size

4.3 Calculation of Bearing Loads

The loads applied on bearings generally include the weight of the body to be supported by the bearings, the weight of the revolving elements themselves, the transmission power of gears and belting, the load produced by the operation of the machine in which the bearings are used, etc. These loads can be theoretically calculated, but some of them are difficult to estimate. Therefore, it becomes necessary to correct the estimated using empirically derived data.

4.3.1 Load Factor

When a radial or axial load has been mathematically calculated, the actual load on the bearing may be greater than the calculated load because of vibration and shock present during operation of the machine. The actual load may be calculated using the following equation:

$$\left. \begin{aligned} F_r &= f_w \cdot F_{rc} \\ F_a &= f_w \cdot F_{ac} \end{aligned} \right\} \dots\dots\dots (4.15)$$

where F_r, F_a : Loads applied on bearing (N), {kgf}
 F_{rc}, F_{ac} : Theoretically calculated load (N), {kgf}
 f_w : Load factor

The values given in Table 4.6 are usually used for the load factor f_w .

Table 4.6 Values of Load Factor f_w

Operating Conditions	Typical Applications	f_w
Smooth operation free from shocks	Electric motors, Machine tools, Air conditioners	1 to 1.2
Normal operation	Air blowers, Compressors, Elevators, Cranes, Paper making machines	1.2 to 1.5
Operation accompanied by shock and vibration	Construction equipment, Crushers, Vibrating screens, Rolling mills	1.5 to 3

4.3.2 Bearing Loads in Belt or Chain Transmission Applications

The force acting on the pulley or sprocket wheel when power is transmitted by a belt or chain is calculated using the following equations.

$$\left. \begin{aligned} M &= 9\,550\,000 H / n \dots (N \cdot mm) \\ &= 974\,000 H / n \dots (kgf \cdot mm) \end{aligned} \right\} \dots\dots\dots (4.16)$$

$$P_k = M / r \dots\dots\dots (4.17)$$

where M : Torque acting on pulley or sprocket wheel (N · mm), {kgf · mm}
 P_k : Effective force transmitted by belt or chain (N), {kgf}
 H : Power transmitted (kW)
 n : Speed (min⁻¹)
 r : Effective radius of pulley or sprocket wheel (mm)

When calculating the load on a pulley shaft, the belt tension must be included. Thus, to calculate the actual load K_b in the case of a belt transmission, the effective transmitting power is multiplied by the belt factor f_b , which represents the belt tension. The values of the belt factor f_b for different types of belts are shown in Table 4.7.

$$K_b = f_b \cdot P_k \dots\dots\dots (4.18)$$

In the case of a chain transmission, the values corresponding to f_b should be 1.25 to 1.5.

Table 4.7 Belt Factor f_b

Type of Belt	f_b
Toothed belts	1.3 to 2
V belts	2 to 2.5
Flat belts with tension pulley	2.5 to 3
Flat belts	4 to 5

4.3.3 Bearing Loads in Gear Transmission Applications

The loads imposed on gears in gear transmissions vary according to the type of gears used. In the simplest case of spur gears, the load is calculated as follows:

$$\left. \begin{aligned} M &= 9\,550\,000 \frac{H}{n} \dots (\text{N} \cdot \text{mm}) \\ &= 974\,000 \frac{H}{n} \dots (\text{kgf} \cdot \text{mm}) \end{aligned} \right\} \dots \dots \dots (4.19)$$

$$P_k = M / r \dots \dots \dots (4.20)$$

$$S_k = P_k \tan \theta \dots \dots \dots (4.21)$$

$$K_c = \sqrt{P_k^2 + S_k^2} = P_k \sec \theta \dots \dots \dots (4.22)$$

where M : Torque applied to gear
($\text{N} \cdot \text{mm}$), { $\text{kgf} \cdot \text{mm}$ }

P_k : Tangential force on gear (N), { kgf }

S_k : Radial force on gear (N), { kgf }

K_c : Combined force imposed on gear
(N), { kgf }

H : Power transmitted (kW)

n : Speed (min^{-1})

r : Pitch circle radius of drive gear (mm)

θ : Pressure angle

In addition to the theoretical load calculated above, vibration and shock (which depend on how accurately the gear is finished) should be included using the gear factor f_g by multiplying the theoretically calculated load by this factor.

The values of f_g should generally be those in Table 4.8. When vibration from other sources accompanies gear operation, the actual load is obtained by multiplying the load factor by this gear factor.

Table 4.8 Values of Gear Factor f_g

Gear Finish Accuracy	f_g
Precision ground gears	1 ~ 1.1
Ordinary machined gears	1.1 ~ 1.3

4.3.4 Load Distribution on Bearings

In the simple examples shown in Figs. 4.11 and 4.12. The radial loads on bearings I and II can be calculated using the following equations:

$$F_{cI} = \frac{b}{c} K \dots \dots \dots (4.23)$$

$$F_{cII} = \frac{a}{c} K \dots \dots \dots (4.24)$$

where F_{cI} : Radial load applied on bearing I (N), { kgf }

F_{cII} : Radial load applied on bearing II (N), { kgf }

K : Shaft load (N), { kgf }

When these loads are applied simultaneously, first the radial load for each should be obtained, and then, the sum of the vectors may be calculated according to the load direction.

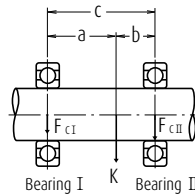

Fig. 4.11 Radial Load Distribution (1)

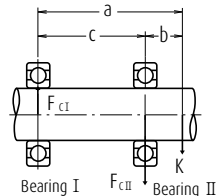

Fig. 4.12 Radial Load Distribution (2)

Selection of Bearing Size

4.3.5 Average of Fluctuating Load

When the load applied on bearings fluctuates, an average load which will yield the same bearing life as the fluctuating load should be calculated.

(1) When the relation between load and rotating speed is divided into the following steps (Fig. 4.13)

- Load F_1 : Speed n_1 ; Operating time t_1
- Load F_2 : Speed n_2 ; Operating time t_2
- ⋮
- Load F_n : Speed n_n ; Operating time t_n

Then, the average load F_m may be calculated using the following equation:

$$F_m = \sqrt[\rho]{\frac{F_1^\rho n_1 t_1 + F_2^\rho n_2 t_2 + \dots + F_n^\rho n_n t_n}{n_1 t_1 + n_2 t_2 + \dots + n_n t_n}} \quad (4.25)$$

where F_m : Average fluctuating load (N), {kgf}

$\rho = 3$ for ball bearings

$\rho = 10/3$ for roller bearings

The average speed n_m may be calculated as follows:

$$n_m = \frac{n_1 t_1 + n_2 t_2 + \dots + n_n t_n}{t_1 + t_2 + \dots + t_n} \quad (4.26)$$

(2) When the load fluctuates almost linearly (Fig. 4.14), the average load may be calculated as follows:

$$F_m \approx \frac{1}{3} (F_{\min} + 2F_{\max}) \quad (4.27)$$

where F_{\min} : Minimum value of fluctuating load (N), {kgf}

F_{\max} : Maximum value of fluctuating load (N), {kgf}

(3) When the load fluctuation is similar to a sine wave (Fig. 4.15), an approximate value for the average load F_m may be calculated from the following equation:

In the case of Fig. 4.15 (a)

$$F_m \approx 0.65 F_{\max} \quad (4.28)$$

In the case of Fig. 4.15 (b)

$$F_m \approx 0.75 F_{\max} \quad (4.29)$$

(4) When both a rotating load and a stationary load are applied (Fig. 4.16).

F_R : Rotating load (N), {kgf}

F_S : Stationary load (N), {kgf}

An approximate value for the average load F_m may be calculated as follows:

a) Where $F_R \geq F_S$

$$F_m \approx F_R + 0.3F_S + 0.2 \frac{F_S^2}{F_R} \quad (4.30)$$

b) Where $F_R < F_S$

$$F_m \approx F_S + 0.3F_R + 0.2 \frac{F_R^2}{F_S} \quad (4.31)$$

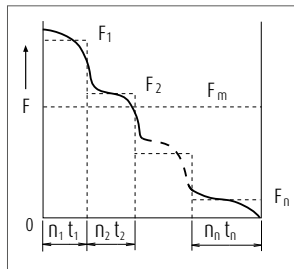

Fig. 4.13 Incremental Load Variation

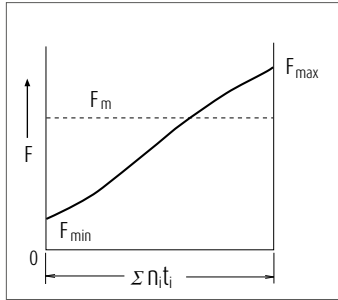

Fig. 4.14 Simple Load Fluctuation

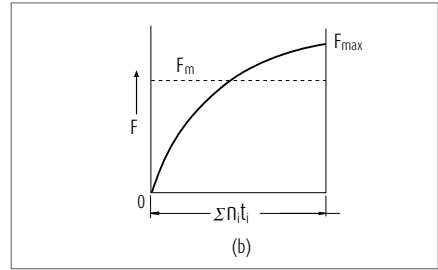
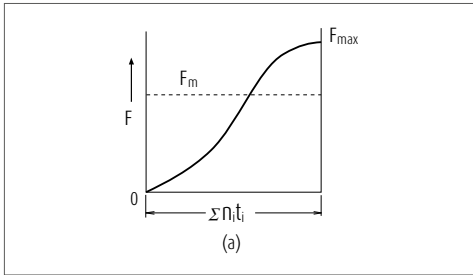

Fig. 4.15 Sinusoidal Load Variation

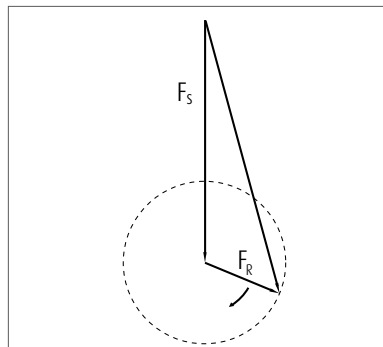

Fig. 4.16 Rotating Load and Stationary Load

Selection of Bearing Size

4.3.6 Combination of Rotating and Stationary Loads

Generally, rotating, static, and indeterminate loads act on a rolling bearing. In certain cases, both the rotating load, which is caused by an unbalanced or a vibration weight, and the stationary load, which is caused by gravity or power transmission, may act simultaneously. The combined mean effective load when the indeterminate load caused by rotating and static loads can be calculated as follows. There are two kinds of combined loads; rotating and stationary which are classified depending on the magnitude of these loads, as shown in Fig. 4.17.

Namely, the combined load becomes a running load with its magnitude changing as shown in Fig. 4.17 (a) if the rotating load is larger than the static load. The combined load becomes an oscillating load with a magnitude changing as shown in Fig. 4.17 (b) if the rotating load is smaller than the stationary load.

In either case, the combined load F is expressed by the following equation:

$$F = \sqrt{F_R^2 + F_S^2 - 2F_R F_S \cos \theta} \quad (4.32)$$

where, F_R : Rotating load (N), {kgf}
 F_S : Stationary load (N), {kgf}
 θ : Angle defined by rotating and stationary loads

The value F can be approximated by Load Equations (4.33) and (4.34) which vary sinusoidally depending on the magnitude of F_R and F_S , that is, in such a manner that $F_R + F_S$ becomes the maximum load F_{max} and $F_R - F_S$ becomes the minimum load F_{min} for $F_R \gg F_S$ or $F_R \ll F_S$.

$$F_R \gg F_S, F = F_R - F_S \cos \theta \quad (4.33)$$

$$F_R \ll F_S, F = F_S - F_R \cos \theta \quad (4.34)$$

The value F can also be approximated by Equations (4.35) and (4.36) when $F_R \neq F_S$.

$F_R > F_S$

$$F = F_R - F_S + 2F_S \sin \frac{\theta}{2} \quad (4.35)$$

$F_R < F_S$

$$F = F_S - F_R + 2F_R \sin \frac{\theta}{2} \quad (4.36)$$

Curves of Equations (4.32), (4.33), (4.35), and (4.36) are as shown in Fig. 4.18.

The mean value F_m of the load varying as expressed by Equations (4.33) and (4.34) or (4.35) and (4.36) can be expressed respectively by Equations (4.37) and (4.38) or (4.39) and (4.40).

$$F_m = F_{min} + 0.65 (F_{max} - F_{min})$$

$$\begin{matrix} F_R & F_S, & F_m = F_R + 0.3F_S & \dots\dots\dots (4.37) \\ F_R & F_S, & F_m = F_S + 0.3F_R & \dots\dots\dots (4.38) \end{matrix}$$

$$F_m = F_{min} + 0.75 (F_{max} - F_{min})$$

$$\begin{matrix} F_R & F_S, & F_m = F_R + 0.5F_S & \dots\dots\dots (4.39) \\ F_R & F_S, & F_m = F_S + 0.5F_R & \dots\dots\dots (4.40) \end{matrix}$$

Generally, as the value F exists somewhere among Equations (4.37), (4.38), (4.39), and (4.40), the factor 0.3 or 0.5 of the second terms of Equations (4.37) and (4.38) as well as (4.39) and (4.40) is assumed to change linearly along with F_S/F_R or F_R/F_S . Then, these factors may be expressed as follows:

$$0.3 + 0.2 \frac{F_S}{F_R}, 0 \quad \frac{F_S}{F_R} \quad 1$$

$$\text{or } 0.3 + 0.2 \frac{F_R}{F_S}, 0 \quad \frac{F_R}{F_S} \quad 1$$

Accordingly, F_m can be expressed by the following equation:

$$F_R > F_S$$

$$F_m = F_R + \left(0.3 + 0.2 \frac{F_S}{F_R}\right) F_S$$

$$= F_R + 0.3F_S + 0.2 \frac{F_S^2}{F_R} \quad (4.41)$$

$$F_R < F_S$$

$$F_m = F_S + \left(0.3 + 0.2 \frac{F_R}{F_S}\right) F_R$$

$$= F_S + 0.3F_R + 0.2 \frac{F_R^2}{F_S} \quad (4.42)$$

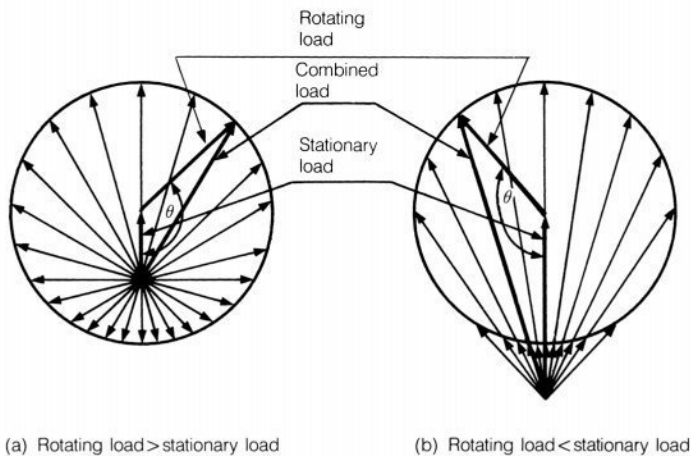

Fig. 4.17 Combined Load of Rotating and Stationary Loads

4

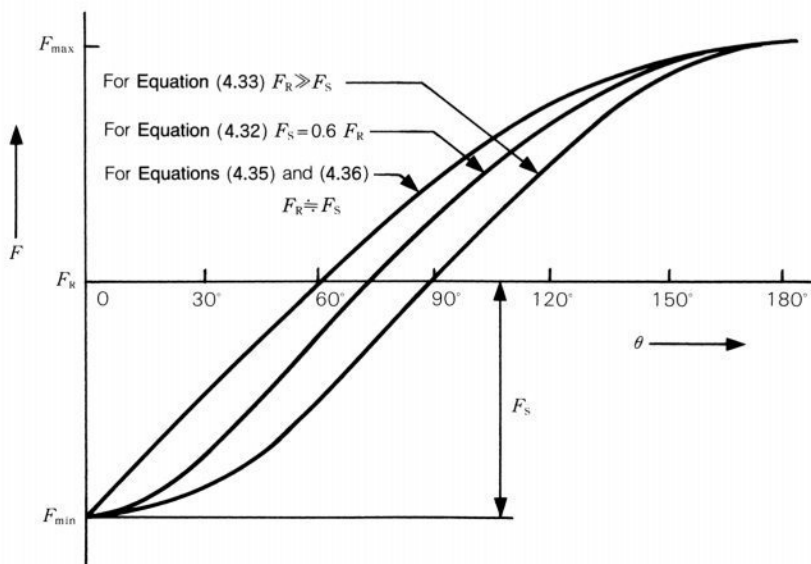

Fig. 4.18 Chart of Combined Loads

Selection of Bearing Size

4.4 Equivalent Load

In some cases, the loads applied on bearings are purely radial or axial loads; however, in most cases, the loads are a combination of both. In addition, such loads usually fluctuate in both magnitude and direction. In such cases, the loads actually applied on bearings cannot be used for bearing life calculations; therefore, a hypothetical load that has a constant magnitude and passes through the center of the bearing, and will give the same bearing life that the bearing would attain under actual conditions of load and rotation should be estimated. Such a hypothetical load is called the equivalent load.

4.4.1 Calculation of Equivalent Loads

The equivalent load on radial bearings may be calculated using the following equation:

$$P = XF_r + YF_a \dots\dots\dots (4.43)$$

where P : Equivalent Load (N), {kgf}

F_r : Radial load (N), {kgf}

F_a : Axial load (N), {kgf}

X : Radial load factor

Y : Axial load factor

The values of X and Y are listed in the bearing tables. The equivalent radial load for radial roller bearings with $\alpha = 0^\circ$ is $P = F_r$

In general, thrust ball bearings cannot take radial loads, but spherical thrust roller bearings can take some radial loads. In this case, the equivalent load may be calculated using the following equation:

$$P = F_a + 1.2F_r \dots\dots\dots (4.44)$$

where $\frac{F_r}{F_a} \leq 0.55$

4.4.2 Axial Load Components in Angular Contact Ball Bearings and Tapered Roller Bearings

The effective load center of both angular contact ball bearings and tapered roller bearings is at the point of intersection of the shaft center line and a line representing the load applied on the rolling element by the outer ring as shown in Fig. 4.19. This effective load center for each bearing is listed in the bearing tables.

When radial loads are applied to these types of bearings, a component of load is produced in the axial direction. In order to balance this component load, bearings of the same type are used in pairs, placed face to face or back to back. These axial loads can be calculated using the following equation:

$$F_{ai} = \frac{0.6}{Y} F_r \quad \text{..... (4.45)}$$

where F_{ai} : Component load in the axial direction (N), {kgf}

F_r : Radial load (N), {kgf}

Y : Axial load factor

Assume that radial loads F_{rI} and F_{rII} are applied on bearings I and II (Fig. 4.20) respectively, and an external axial load F_{ae} is applied as shown. If the axial load factors are Y_I, Y_{II} and the radial load factor is X , then the equivalent loads P_I, P_{II} may be calculated as follows:

where $F_{ae} + \frac{0.6}{Y_{II}} F_{rII} \geq \frac{0.6}{Y_I} F_{rI}$

$$P_I = XF_{rI} + Y_I \left(F_{ae} + \frac{0.6}{Y_{II}} F_{rII} \right) \quad \text{..... (4.46)}$$

$$P_{II} = F_{rII}$$

where $F_{ae} + \frac{0.6}{Y_{II}} F_{rII} < \frac{0.6}{Y_I} F_{rI}$

$$P_I = F_{rI}$$

$$P_{II} = XF_{rII} + Y_{II} \left(\frac{0.6}{Y_I} F_{rI} - F_{ae} \right) \quad \text{..... (4.47)}$$

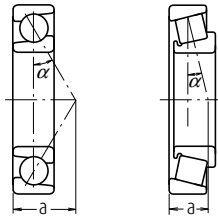

Fig. 4.19 Effective Load Centers

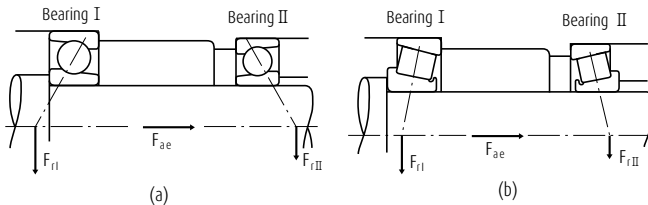

Fig. 4.20 Loads in Opposed Duplex Arrangement

Selection of Bearing Size

4.5 Static Load Ratings and Static Equivalent Loads

4.5.1 Static Load Ratings

When subjected to an excessive load or a strong shock load, rolling bearings may incur a local permanent deformation of the rolling elements and permanent deformation of the rolling elements and raceway surface if the elastic limit is exceeded. The non-elastic deformation increases in area and depth as the load increases, and when the load exceeds a certain limit, the smooth running of the bearing is impeded.

The basic static load rating is defined as that static load which produces the following calculated contact stress at the center of the contact area between the rolling element subjected to the maximum stress and the raceway surface.

For self-aligning ball bearings	4 600 MPa {469 kgf/mm ² }
For other ball bearings	4 200 MPa {428 kgf/mm ² }
For roller bearings	4 000 MPa {408 kgf/mm ² }

In this most heavily stressed contact area, the sum of the permanent deformation of the rolling element and that of the raceway is nearly 0.0001 times the rolling element's diameter. The basic static load rating C_0 is written C_{0r} for radial bearings and C_{0a} for thrust bearings in the bearing tables.

In addition, following the modification of the criteria for basic static load rating by ISO, the new C_0 values for NSK's ball bearings became about 0.8 to 1.3 times the past values and those for roller bearings about 1.5 to 1.9 times. Consequently, the values of permissible static load factor f_s have also changed, so please pay attention to this.

4.5.2 Static Equivalent Loads

The static equivalent load is a hypothetical load that produces a contact stress equal to the above maximum stress under actual conditions, while the bearing is stationary (including very slow rotation or oscillation), in the area of contact between the most heavily stressed rolling element and bearing raceway. The static radial load passing through the bearing center is taken as the static equivalent load for radial bearings, while the static axial load in the direction coinciding with the central axis is taken as the static equivalent load for thrust bearings.

(a) Static equivalent load on radial bearings

The greater of the two values calculated from the following equations should be adopted as the static equivalent load on radial bearings.

$$P_0 = X_0 F_r + Y_0 F_a \dots\dots\dots (4.48)$$

$$P_0 = F_r \dots\dots\dots (4.49)$$

- where P_0 : Static equivalent load (N), {kgf}
- F_r : Radial load (N), {kgf}
- F_a : Axial load (N), {kgf}
- X_0 : Static radial load factor
- Y_0 : Static axial load factor

(b) Static equivalent load on thrust bearings

$$P_0 = X_0 F_r + F_a \quad \alpha \neq 90^\circ \dots\dots\dots (4.50)$$

- where P_0 : Static equivalent load (N), {kgf}
- α : Contact angle

When $F_a < X_0 F_r$, this equation becomes less accurate. The values of X_0 and Y_0 for Equations (4.47) and (4.49) are listed in the bearing tables.

The static equivalent load for thrust roller bearings with

$$\alpha = 90^\circ \text{ is } P_0 = F_a$$

4.5.3 Permissible Static Load Factor

The permissible static equivalent load on bearings varies depending on the basic static load rating and also their application and operating conditions.

The permissible static load factor f_s is a safety factor that is applied to the basic static load rating, and it is defined by the ratio in Equation (4.50). The general recommended values of f_s are listed in Table 4.9. Conforming to the modification of the static load rating, the values of f_s were revised, especially for bearings for which the values of C_0 were increased, please keep this in mind when selecting bearings.

$$f_s = \frac{C_0}{P_0} \dots\dots\dots (4.51)$$

- where C_0 : Basic static load rating (N), {kgf}
- P_0 : Static equivalent load (N), {kgf}

For spherical thrust roller bearings, the values of f_s should be greater than 4.

Table 4.9 Values of Permissible Static Load Factor f_s

Operating Conditions	Lower Limit of f_s	
	Ball Bearings	Roller Bearings
Low-noise applications	2	3
Bearings subjected to vibration and shock loads	1.5	2
Standard operating conditions	1	1.5



Selection of Bearing Size

4.6 Examples of Bearing Calculations

(Example 1)

Obtain the fatigue life factor f_h of single-row deep groove ball bearing **6208** when it is used under a radial load $F_r = 2\,500\text{ N}$, $\{255\text{kgf}\}$ and speed $n = 900\text{ min}^{-1}$.

The basic load rating C_r of **6208** is $29\,100\text{ N}$, $\{2\,970\text{kgf}\}$ (Bearing Table, Page B024) Since only a radial load is applied, the equivalent load P may be obtained as follows:

$$P = F_r = 2\,500\text{ N}, \{255\text{kgf}\}$$

Since the speed is $n = 900\text{ min}^{-1}$, the speed factor f_n can be obtained from the equation in Table 4.2 or Fig. 4.4 (Page A036), it corresponds approximately to 29 000 hours of service life.

$$f_n = 0.333$$

The fatigue life factor f_h , under these conditions, can be calculated as follows:

$$f_h = f_n \frac{C_r}{P} = 0.333 \times \frac{29\,100}{2\,500} = 3.88$$

This value is suitable for industrial applications, air conditioners being regularly used, etc., and according to the equation in Table 4.2 or Fig. 4.4 (Page A036), it corresponds approximately to 29 000 hours of service life.

(Example 2)

Select a single-row deep groove ball bearing with a bore diameter of 50 mm and outside diameter under 100 mm that satisfies the following conditions:

Radial load $F_r = 3\,000\text{ N}$, $\{306\text{kgf}\}$

Speed $n = 1\,900\text{ min}^{-1}$

Basic rating life $L_h \geq 10\,000\text{ h}$

The fatigue life factor f_h of ball bearings with a rating fatigue life longer than 10 000 hours is $f_h \geq 2.72$.

Because $f_n = 0.26$, $P = F_r = 3\,000\text{ N}$, $\{306\text{kgf}\}$

$$f_h = f_n \frac{C_r}{P} = 0.26 \times \frac{C_r}{3\,000} \geq 2.72$$

therefore, $C_r \geq 2.72 \times \frac{3\,000}{0.26} = 31\,380\text{ N}$, $\{3\,200\text{kgf}\}$

Among the data listed in the bearing table on Page B026, **6210** should be selected as one that satisfies the above conditions.

(Example 3)

Obtain C_r / P or fatigue life factor f_h when an axial load $F_a = 1\,000\text{ N}$, $\{102\text{kgf}\}$ is added to the conditions of (Example 1)

When the radial load F_r and axial load F_a are applied on single-row deep groove ball bearing **6208**, the dynamic equivalent load P should be calculated in accordance with the following procedure.

Obtain the radial load factor X , axial load factor Y and constant e obtainable, depending on the magnitude of $f_0 F_a / C_{or}$, from the table above the single-row deep groove ball bearing table.

The basic static load rating C_{or} of ball bearing **6208** is $17\,900\text{ N}$, $\{1\,820\text{kgf}\}$ (Page B024)

$$f_0 F_a / C_{or} = 14.0 \times 1\,000 / 17\,900 = 0.782$$

e H 0.26

and $F_a / F_r = 1\,000 / 2\,500 = 0.4 > e$

$X = 0.56$

$Y = 1.67$ (the value of Y is obtained by linear interpolation)

Therefore, the dynamic equivalent load P is

$$\begin{aligned} P &= X F_r + Y F_a \\ &= 0.56 \times 2\,500 + 1.67 \times 1\,000 \\ &= 3\,070\text{ N}, \{313\text{kgf}\} \end{aligned}$$

$$\frac{C_r}{P} = \frac{29\,100}{3\,070} = 9.48$$

$$f_h = f_n \frac{C_r}{P} = 0.333 \times \frac{29\,100}{3\,070} = 3.16$$

This value of f_h corresponds approximately to 15 800 hours for ball bearings.

(Example 4)

Select a spherical roller bearing of series 231 satisfying the following conditions:

Radial load $F_r = 45\,000\text{ N}$, $\{4\,950\text{kgf}\}$

Axial load $F_a = 8\,000\text{ N}$, $\{816\text{kgf}\}$

Speed $n = 500\text{ min}^{-1}$

Basic rating life $L_h \geq 30\,000\text{ h}$

The value of the fatigue life factor f_h which makes $L_h \geq 30\,000\text{ h}$ is bigger than 3.45 from Fig. 4.4 (Page A036).

The dynamic equivalent load P of spherical roller bearings is given by:

when $F_a / F_r \leq e$

$$P = XF_r + YX_a = F_r + Y_3 F_a$$

when $F_a / F_r > e$

$$P = XF_r + YF_a = 0.67 F_r + Y_2 F_a$$

$$F_a / F_r = 8\,000 / 45\,000 = 0.18$$

We can see in the bearing table that the value of e is about 0.3 and that of Y_3 is about 2.2 for bearings of series 231:

$$\begin{aligned} \text{Therefore, } P &= XF_r + YF_a = F_r + Y_3 F_a \\ &= 45\,000 + 2.2 \times 8\,000 \\ &= 62\,600\text{N, } \{6\,380\text{kgf}\} \end{aligned}$$

From the fatigue life factor f_h , the basic load rating can be obtained as follows:

$$f_h = f_n \frac{C_r}{P} = 0.444 \times \frac{C_r}{62\,600} \geq 3.45$$

consequently, $C_r \geq 490\,000\text{N}$, $\{50\,000\text{kgf}\}$

Among spherical roller bearings of series 231 satisfying this value of C_r , the smallest is **23126CE4**

($C_r = 505\,000\text{N}$, $\{51\,500\text{kgf}\}$)

Once the bearing is determined, substitute the value of Y_3 in the equation and obtain the value of P .

$$\begin{aligned} P &= F_r + Y_3 F_a = 45\,000 + 2.4 \times 8\,000 \\ &= 64\,200\text{N, } \{6\,550\text{kgf}\} \end{aligned}$$

$$\begin{aligned} L_h &= 500 \left(f_n \frac{C_r}{P} \right)^{\frac{10}{3}} \\ &= 500 \left(0.444 \times \frac{505\,000}{64\,200} \right)^{\frac{10}{3}} \\ &= 500 \times 3.49^{\frac{10}{3}} = 1\,320\,000 \text{ h} \end{aligned}$$

(Example 5)

Assume that tapered roller bearings **HR30305DJ** and **HR30206J** are used in a back-to-back arrangement as shown in Fig. 4.21, and the distance between the cup back faces is 50 mm.

Calculate the basic rating life of each bearing when beside the radial load $F_r = 5\,500\text{N}$, $\{561\text{kgf}\}$,

axial load $F_{ae} = 2\,000\text{N}$, $\{204\text{kgf}\}$ are applied to **HR30305DJ** as shown in Fig. 4.21. The speed is 600 min^{-1} .

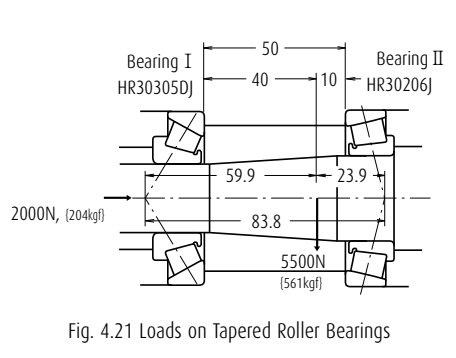

Fig. 4.21 Loads on Tapered Roller Bearings

To distribute the radial load F_r on bearings I and II, the effective load centers must be located for tapered roller bearings. Obtain the effective load center a for bearings I and II from the bearing table, then obtain the relative position of the radial load F_r and effective load centers. The result will be as shown in Fig. 4.21. Consequently, the radial load applied on bearings I (**HR30305DJ**) and II (**HR30206J**) can be obtained from the following equations:

$$F_{rI} = 5\,500 \times \frac{23.9}{83.8} = 1\,569\text{N, } \{160\text{kgf}\}$$

$$F_{rII} = 5\,500 \times \frac{59.9}{83.8} = 3\,931\text{N, } \{401\text{kgf}\}$$

From the data in the bearing table, the following values are obtained;

Bearings	Basic dynamic load rating C_r (N) (kgf)	Axial load factor Y_1	Constant e
Bearing I (HR30305DJ)	38 000 (3 900)	$Y_{I} = 0.73$	0.83
Bearing II (HR30206J)	43 000 (4 400)	$Y_{II} = 1.6$	0.38

When radial loads are applied on tapered roller bearings, an axial load component is produced, which must be considered to obtain the dynamic equivalent radial load (Refer to Paragraph 4.4.2, Page A051).

Selection of Bearing Size

$$F_{ae} + \frac{0.6}{Y_{II}} F_{rII} = 2\,000 + \frac{0.6}{1.6} \times 3\,931$$

$$= 3\,474\text{N}, \quad \{354\text{kgf}\}$$

$$\frac{0.6}{Y_I} F_{rI} = \frac{0.6}{0.73} \times 1\,569 = 1\,290\text{N}, \quad \{132\text{kgf}\}$$

Therefore, with this bearing arrangement, the axial load $F_{ae} + \frac{0.6}{Y_{II}} F_{rII}$ is applied on bearing I but not on bearing II.

For bearing I

$$F_{rI} = 1\,569\text{N}, \quad \{160\text{kgf}\}$$

$$F_{aI} = 3\,474\text{N}, \quad \{354\text{kgf}\}$$

since $F_{aI} / F_{rI} = 2.2 > e = 0.83$

the dynamic equivalent load $P_I = X_{FI} + Y_I F_{aI}$

$$= 0.4 \times 1\,569 + 0.73 \times 3\,474$$

$$= 3\,164\text{N}, \quad \{323\text{kgf}\}$$

The fatigue life factor $f_h = f_n \frac{C_r}{P_I}$

$$= \frac{0.42 \times 38\,000}{3\,164} = 5.04$$

and the rating fatigue life $L_h = 500 \times 5.04^{\frac{10}{3}} = 109\,750\text{ h}$

For bearing II

since $F_{rII} = 3\,931\text{N}$, $\{401\text{kgf}\}$, $F_{aII} = 0$

the dynamic equivalent load

$$P_{II} = F_{rII} = 3\,931\text{N}, \quad \{401\text{kgf}\}$$

the fatigue life factor

$$f_h = f_n \frac{C_r}{P_{II}} = \frac{0.42 \times 43\,000}{3\,931} = 4.59$$

and the rating fatigue life $L_h = 500 \times 4.59^{\frac{10}{3}} = 80\,400\text{ h}$ are obtained.

Remark For face-to-face arrangements (DF type), please contact NSK.

(Example 6)

Select a bearing for a speed reducer under the following conditions:

Operating conditions

Radial load $F_r = 245\,000\text{N}$, $\{25\,000\text{kgf}\}$

Axial load $F_a = 49\,000\text{N}$, $\{5\,000\text{kgf}\}$

Speed $n = 500\text{ min}^{-1}$

Size limitation

Shaft diameter: 300 mm

Bore of housing: Less than 500 mm

In this application, heavy loads, shocks, and shaft deflection are expected; therefore, spherical roller bearings are appropriate.

The following spherical roller bearings satisfy the above size limitation (refer to Page B302)

d	D	B	Bearing No.	Basic dynamic load rating C_r (N)	Constant e	Factor Y_3
300	420	90	23960 CAE4	1 540 000	0.19	3.5
	460	118	23060 CAE4	2 400 000	0.24	2.8
	460	160	24060 CAE4	2 890 000	0.32	2.1
500	160		23160 CAE4	3 350 000	0.31	2.2
	200		24160 CAE4	3 900 000	0.38	1.8

since $F_a / F_r = 0.20 < e$

the dynamic equivalent load P is

$$P = F_r + Y_3 F_a$$

Judging from the fatigue life factor f_h in Table 4.1 and examples of applications (refer to Page A034), a value of f_h , between 3 and 5 seems appropriate.

$$f_h = f_n \frac{C_r}{P} = \frac{0.444 C_r}{F_r + Y_3 F_a} = 3 \text{ to } 5$$

Assuming that $Y_3 = 2.1$, then the necessary basic load rating C_r can be obtained

$$C_r = \frac{(F_r + Y_3 F_a) \times (3 \text{ to } 5)}{0.444}$$

$$= \frac{(245\,000 + 2.1 \times 49\,000) \times (3 \text{ to } 5)}{0.444}$$

$$= 2\,350\,000 \text{ to } 3\,900\,000\text{ N},$$

{240 000 to 400 000 kgf}

The bearings which satisfy this range are **23060CAE4**, **24060CAE4**, **23160CAE4**, and **24160CAE4**.



Selection of Bearing Size

4.7 Bearing Type and Allowable Axial Load

4.7.1 Change of Contact Angle of Radial Ball Bearings and Allowable Axial Load

(1) Change of Contact Angle Due to Axial Load

When an axial load acts on a radial ball bearing, the rolling element and raceway develop elastic deformation, resulting in an increase in the contact angle and width. When heat generation or seizure has occurred, the bearing should be disassembled and checked for running trace to discover whether there has been a change in the contact angle during operation. In this way, it is possible to see whether an abnormal axial load has been sustained.

The relation shown below can be established among the axial load F_a on a bearing, the load of rolling element Q , and the contact angle α when the load is applied. (See Equations (9.7), (9.8), and (9.10) in Section 9.6.2)

$$F_a = Z Q \sin \alpha$$

$$= K Z D_w^2 \{ \sqrt{(\sin \alpha_0 + h)^2 + \cos^2 \alpha_0 - 1} \}^{3/2} \sin \alpha \quad (4.52)$$

$$\alpha = \sin^{-1} \frac{\sin \alpha_0 + h}{\sqrt{(\sin \alpha_0 + h)^2 + \cos^2 \alpha_0}} \quad (4.53)$$

$$h = \frac{\delta_a}{m_0} = \frac{\delta_a}{r_e + f_i - D_w}$$

Namely, δ_a is the change in Equation (4.52) to determine α corresponding to the contact angle known from observation of the raceway. Thus, δ_a and α are introduced into Equation (4.51) to estimate the axial load F_a acting on the bearing. As specifications of a bearing are necessary in this case for calculation, the contact angle α was approximated from the axial load. The basic static load rating C_{0r} is expressed by Equation (4.53) for the case of a single row radial ball bearing.

$$C_{0r} = f_0 Z D_w^2 \cos \alpha_0 \quad (4.54)$$

where, f_0 : Factor determined from the shape of bearing components and applicable stress level

Equation (4.54) is determined from Equations (4.51) and (4.53):

$$\frac{f_0}{C_{0r}} F_a = A F_a$$

$$= K \{ \sqrt{(\sin \alpha_0 + h)^2 + \cos^2 \alpha_0 - 1} \}^{3/2} \frac{\sin \alpha}{\cos \alpha_0} \quad (4.55)$$

where, K : Constant determined from material and design of bearing

In other words, "h" is assumed and α is determined from Equation (4.52). Then "h" and α are introduced into Equation (4.54) to determine $A F_a$. This relation is used to show the value A for each bore number of an angular contact ball bearing in Table 4.14. The relationship between $A F_a$ and α is shown in Fig. 4.22.

Example 1

Change in the contact angle is calculated when the pure axial load $F_a = 35.0$ kN (50% of basic static load rating) is applied to an angular contact ball bearing 7215C.

$A = 0.212$ is calculated from Table 4.10 and

$A F_a = 0.212 \times 35.0 = 7.42$ and $\alpha = 126^\circ$ are obtained from Fig. 4.22. An initial contact angle of 15° has changed to 26° under the axial load.

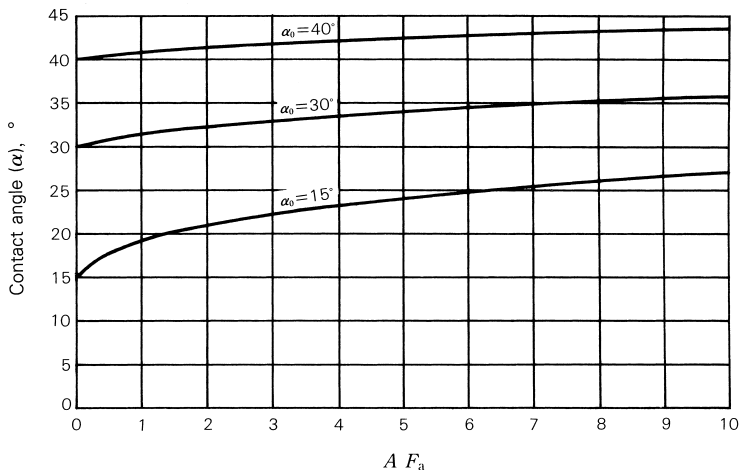

Fig. 4.22 Change of the Contact Angle of Angular Contact Ball Bearing under Axial Load

Table 4.10 Constant A Value of Angular Contact Ball Bearing

Units: kN^{-1}

Bearing bore No.	Bearing series 70			Bearing series 72			Bearing series 73		
	15°	30°	40°	15°	30°	40°	15°	30°	40°
05	1.97	2.05	2.31	1.26	1.41	1.59	0.838	0.850	0.961
06	1.45	1.51	1.83	0.878	0.979	1.11	0.642	0.651	0.736
07	1.10	1.15	1.38	0.699	0.719	0.813	0.517	0.528	0.597
08	0.966	1.02	1.22	0.562	0.582	0.658	0.414	0.423	0.478
09	0.799	0.842	1.01	0.494	0.511	0.578	0.309	0.316	0.357
10	0.715	0.757	0.901	0.458	0.477	0.540	0.259	0.265	0.300
11	0.540	0.571	0.681	0.362	0.377	0.426	0.221	0.226	0.255
12	0.512	0.542	0.645	0.293	0.305	0.345	0.191	0.195	0.220
13	0.463	0.493	0.584	0.248	0.260	0.294	0.166	0.170	0.192
14	0.365	0.388	0.460	0.226	0.237	0.268	0.146	0.149	0.169
15	0.348	0.370	-	0.212	0.237	0.268	0.129	0.132	0.149
16	0.284	0.302	0.358	0.190	0.199	0.225	0.115	0.118	0.133
17	0.271	0.288	0.341	0.162	0.169	0.192	0.103	0.106	0.120
18	0.228	0.242	0.287	0.140	0.146	0.165	0.0934	0.0955	0.108
19	0.217	0.242	0.273	0.130	0.136	0.153	0.0847	0.0866	0.0979
20	0.207	0.231	0.261	0.115	0.119	0.134	0.0647	0.0722	0.0816

Selection of Bearing Size

Values for a deep groove ball bearing are similarly shown in Table 4.11 and Fig. 4.23.

Example 2

Change in the contact angle is calculated when the pure axial load $F_a=24.75$ kN (50% of the basic static load rating) is applied to the deep groove ball bearing 6215. Note here that the radial internal clearance is calculated as the median (0.020 mm) of the normal clearance.

The initial contact angle 10° is obtained from Fig. 3, Page B015. $A=0.303$ is determined from Table 4.11 and $A F_a = 0.303 \times 24.75=7.5$ and $a=H24^\circ$ from Fig. 4.23.

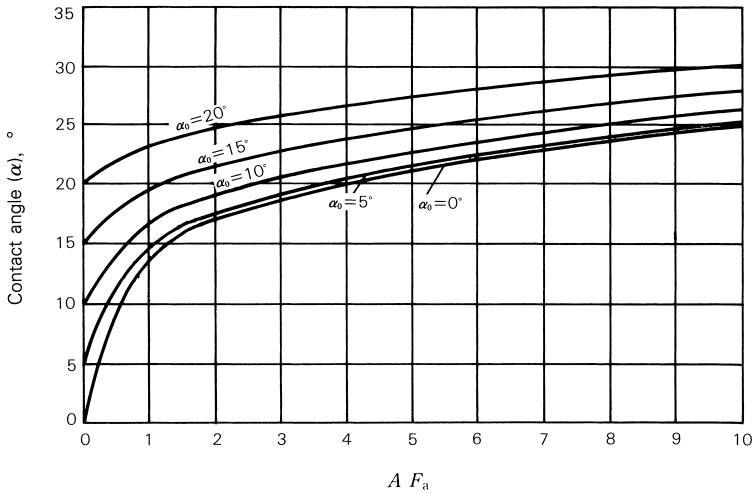

Fig. 4.23 Change in the Contact Angle of the Deep Groove Ball Bearing under Axial Load

Table 4.11 Constant A Value of Angular Contact Ball Bearing

Units: kN^{-1}

Bearing bore No.	Bearing series 62				
	0°	5°	10°	15°	20°
05	1.76	1.77	1.79	1.83	1.88
06	1.22	1.23	1.24	1.27	1.30
07	0.900	0.903	0.914	0.932	0.958
08	0.784	0.787	0.796	0.811	0.834
09	0.705	0.708	0.716	0.730	0.751
10	0.620	0.622	0.630	0.642	0.660
11	0.490	0.492	0.497	0.507	0.521
12	0.397	0.398	0.403	0.411	0.422
13	0.360	0.361	0.365	0.373	0.383
14	0.328	0.329	0.333	0.340	0.349
15	0.298	0.299	0.303	0.309	0.317
16	0.276	0.277	0.280	0.285	0.293
17	0.235	0.236	0.238	0.243	0.250
18	0.202	0.203	0.206	0.210	0.215
19	0.176	0.177	0.179	0.183	0.188
20	0.155	0.156	0.157	0.160	0.165

Selection of Bearing Size

(2) Allowable Axial Load for a Deep Groove Ball Bearing

The allowable axial load here means the limit load at which a contact ellipse is generated between the ball and raceway due to a change in the contact angle when a radial bearing, which is under an axial load, rides over the shoulder of the raceway groove. This is different from the limit value of a static equivalent load P_0 which is determined from the basic static load rating C_{0r} using the static axial load factor Y_0 . Note also that the contact ellipse may ride over the shoulder even when the axial load on the bearing is below the limit value of P_0 .

The allowable axial load $F_a \text{ max}$ of a radial ball bearing is determined as follows. The contact angle α for F_a is determined from the right term of Equation (4.51) and Equation (4.52) while Q is calculated as follows:

$$Q = \frac{F_a}{Z \sin \alpha}$$

θ of Fig. 4.24 is also determined as follows:

$$2a = A_2 \mu \left(\frac{Q}{\Sigma p} \right)^{1/3}$$

$$\therefore \theta = H \frac{a}{r}$$

Accordingly, the allowable axial load may be determined as the maximum axial load at which the following relation is established.

$$\gamma = \alpha + \theta$$

As the allowable axial load cannot be determined unless internal specifications of a bearing are known, Fig. 4.25 shows the result of a calculation to determine the allowable axial load for a deep groove radial ball bearing.

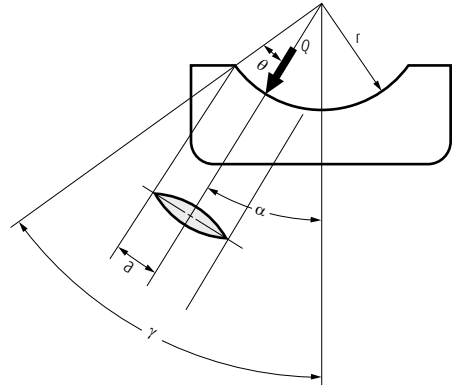

Fig. 4.24

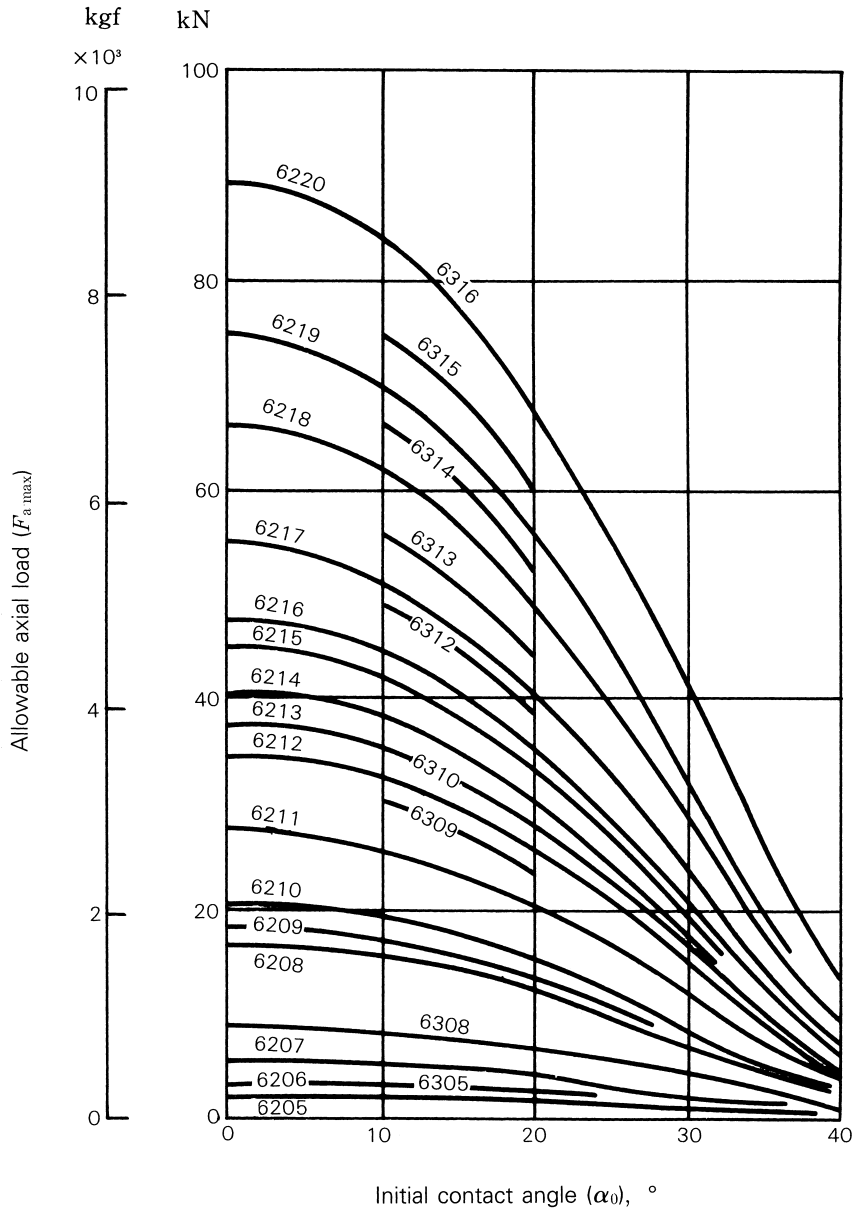

Fig. 4.25 Allowable Axial Load for a Deep Groove Ball Bearing

Selection of Bearing Size

4.7.2 Allowable Axial Load (Break Down Strength of The Ribs) for a Cylindrical Roller Bearings

Both the inner and outer rings may be exposed to an axial load to a certain extent during rotation in a cylindrical roller bearing with ribs. The axial load capacity is limited by heat generation, seizure, etc. at the slip surface between the roller end surface and rib, or the rib strength.

The allowable axial load (the load considered the heat generation between the end face of rollers and the rib face) for the cylindrical roller bearing of the diameter series 3, which is applied continuously under grease or oil lubrication, is shown in Fig. 4.26.

Grease lubrication (Empirical equation)

$$C_A = 9.8 f \left\{ \frac{900 (k \cdot d)^2}{n + 1500} - 0.023 \times (k \cdot d)^{2.5} \right\} \text{ (N)}$$

$$= f \left\{ \frac{900 (k \cdot d)^2}{n + 1500} - 0.023 \times (k \cdot d)^{2.5} \right\} \text{ {kgf}}$$

..... (4.56)

Oil lubrication (Empirical equation)

$$C_A = 9.8 f \left\{ \frac{490 (k \cdot d)^2}{n + 1000} - 0.000135 \times (k \cdot d)^{3.4} \right\} \text{ (N)}$$

$$= f \left\{ \frac{490 (k \cdot d)^2}{n + 1000} - 0.000135 \times (k \cdot d)^{3.4} \right\} \text{ {kgf}}$$

..... (4.57)

- where, C_A : Allowable axial load (N), {kgf}
 d : Bearing bore diameter (mm)
 n : Bearing speed (min⁻¹)
 f : Load factor
 k : Dimensional factor

In the equations (4.55) and (4.56), the examination for the rib strength is excluded. Concerning the rib strength, please consult with NSK.

To enable the cylindrical roller bearing to sustain the axial load capacity stably, it is necessary to take into account the following points concerning the bearing and its surroundings.

- a Radial load must be applied and the magnitude of radial load should be larger than that of axial load by 2.5 times or more.
- a There should be sufficient lubricant between the roller end face and rib.
- a Use a lubricant with an additive for extreme pressures.
- a Running-in-time should be sufficient.
- a Bearing mounting accuracy should be good.
- a Don't use a bearing with an unnecessarily large internal clearance.

Moreover, if the bearing speed is very slow or exceeds 50% of the allowable speed in the bearing catalog, or if the bearing bore diameter exceeds 200 mm, it is required for each bearing to be precisely checked for lubrication, cooling method, etc. Please contact NSK in such cases.

f : Load factor

	f value
Continuous loading	1
Intermittent loading	2
Short time loading	3

k : Dimensional factor

	k value
Bearing diameter series 2	0.75
Bearing diameter series 3	1
Bearing diameter series 4	1.2

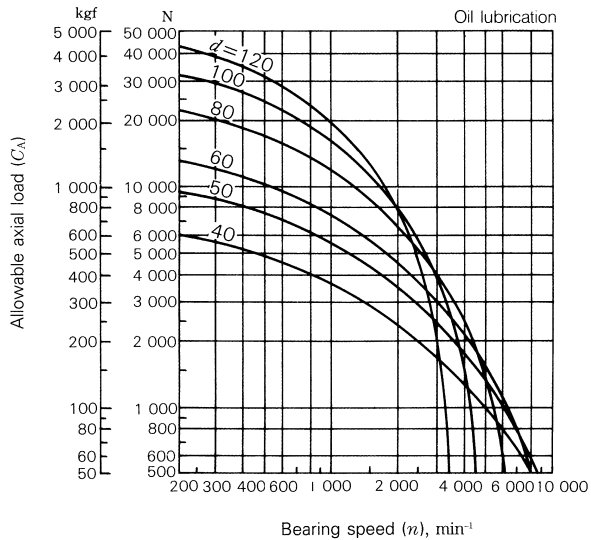
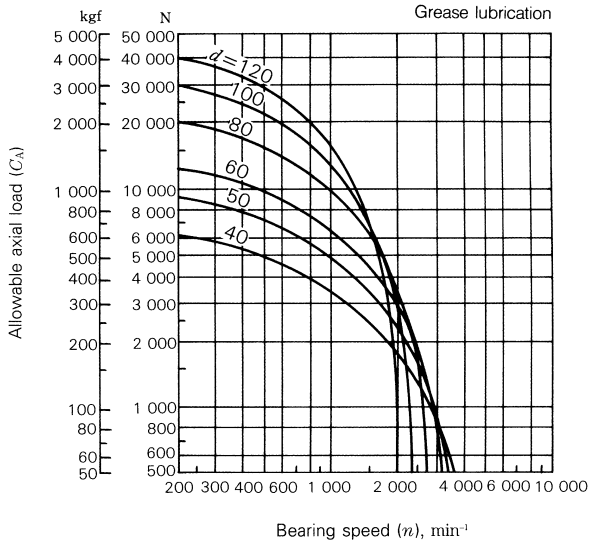

Conditions are continuous loading ($f=1$) and bearing diameter series 3 ($k=1.0$)

Fig. 4.26 Allowable Axial Load for a Cylindrical Roller Bearing

Selection of Bearing Size

4.8 Technical Data

4.8.1 Fatigue Life and Reliability

Where any part failure may result in damage to the entire machine and repair of damage is impossible, as in applications such as aircraft, satellites, or rockets, greatly increased reliability is demanded of each component. This concept is being applied generally to durable consumer goods and may also be utilized to achieve effective preventive maintenance of machines and equipment.

The rating fatigue life of a rolling bearing is the gross number of revolutions or the gross rotating period when the rotating speed is constant for which 90% of a group of similar bearings running individually under similar conditions can rotate without suffering material damage due to rolling fatigue. In other words, fatigue life is normally defined at 90% reliability. There are other ways to describe the life. For example, the average value is employed frequently to describe the life span of human beings. However, if the average value were used for bearings, then too many bearings would fail before the average life value is reached. On the other hand, if a low or minimum value is used as a criterion, then too many bearings would have a life much longer than the set value. In this view, the value 90% was chosen for common practice. The value 95% could have been taken as the statistical reliability, but nevertheless, the slightly looser reliability of 90% was taken for bearings empirically from the practical and economical viewpoint. A 90% reliability however is not acceptable for parts of aircraft or electronic computers or communication systems these days, and a 99% or 99.9% reliability is demanded in some of these cases.

The fatigue life distribution when a group of similar bearings are operated individually under similar conditions is shown in Fig. 4.27. The Weibull equation can be used to describe the fatigue life distribution

within a damage ratio of 10 to 60% (residual probability of 90 to 40%). Below the damage ratio of 10% (residual probability of 90% or more), however, the rolling fatigue life becomes longer than the theoretical curve of the Weibull distribution, as shown in Fig. 4.28. This is a conclusion drawn from the life test of numerous, widely-varying bearings and an analysis of the data.

When bearing life with a failure ratio of 10% or less (for example, the 95% life or 98% life) is to be considered on the basis of the above concept, the reliability factor a_1 as shown in the table below is used to check the life. Assume here that the 98% life L_2 is to be calculated for a bearing whose rating fatigue life L_{10} was calculated at 10 000 hours. The life can be calculated as $L_2 = 0.37 \times L_{10} = 3\ 700$ hours. In this manner, the reliability of the bearing life can be matched to the degree of reliability required of the equipment and difficulty of overhaul and inspection.

Table 4.12 Reliability factor

Reliability, %	90	95	96	97	98	99
Life, L	L_{10} rating life	L_5	L_4	L_3	L_2	L_1
Reliability factor, a_1	1	0.64	0.55	0.47	0.37	0.25

Apart from rolling fatigue, factors such as lubrication, wear, sound, and accuracy govern the durability of a bearing. These factors must be taken into account, but the endurance limit of these factors varies depending on application and conditions.

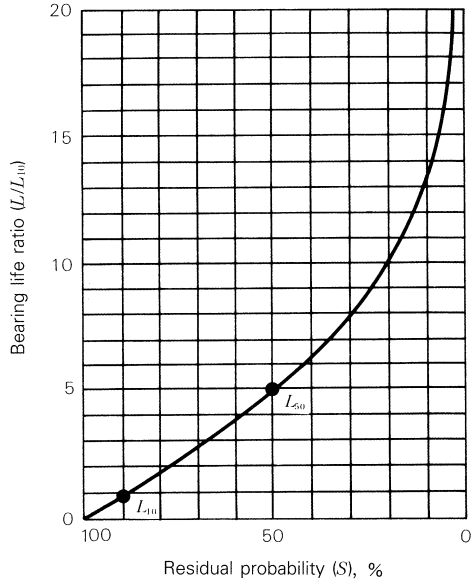

Fig. 4.27 Bearing Life and Residual Probability

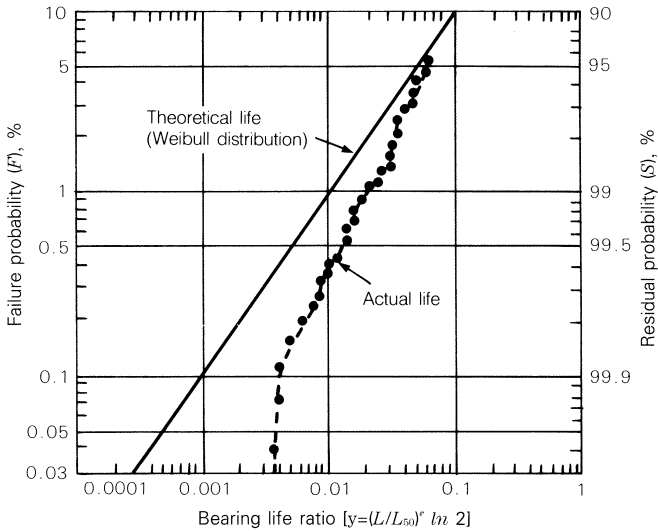

Fig. 4.28 Life Distribution in the Low Failure Ratio Range

Selection of Bearing Size

4.8.2 Radial Clearance and Fatigue Life

As shown in the catalog, etc., the fatigue life calculation equation of rolling bearings is Equation (4.57):

$$L = \left(\frac{C}{P} \right)^p \dots\dots\dots (4.58)$$

where, L : Rating fatigue life (10⁶rev)
 C : Basic dynamic load rating (N), {kgf}
 P : Dynamic equivalent load (N), {kgf}
 p : Index Ball bearing p=3,
 Roller bearing p= $\frac{10}{3}$

The rating fatigue life L for a radial bearing in this case is based on a prerequisite that the load distribution in the bearing corresponds to the state with the load factor $\epsilon = 0.5$ (Fig. 4.29). The load distribution with $\epsilon = 0.5$ is obtained when the bearing internal clearance is zero. In this sense, the normal fatigue life calculation is intended to obtain the value when the clearance is zero. When the effect of the radial clearance is taken into account, the bearing fatigue life can be calculated as follows. Equations (4.58) and (4.59) can be established between the bearing radial clearance ϵ_r and a function $f(\epsilon)$ of load factor ϵ :

For deep groove ball bearing

$$\left. \begin{aligned} f(\epsilon) &= \frac{\epsilon_r \cdot D_w^{1/3}}{0.00044 \left(\frac{F_r}{Z} \right)^{2/3}} \dots\dots\dots (N) \\ f(\epsilon) &= \frac{\epsilon_r \cdot D_w^{1/3}}{0.002 \left(\frac{F_r}{Z} \right)^{2/3}} \dots\dots\dots \{kgf\} \end{aligned} \right\} \dots\dots (4.59)$$

For cylindrical roll bearing

$$\left. \begin{aligned} f(\epsilon) &= \frac{\epsilon_r \cdot L_{we}^{0.8}}{0.000077 \left(\frac{F_r}{Z \cdot i} \right)^{0.9}} \dots\dots\dots (N) \\ f(\epsilon) &= \frac{\epsilon_r \cdot L_{we}^{0.8}}{0.0006 \left(\frac{F_r}{Z \cdot i} \right)^{0.9}} \dots\dots\dots \{kgf\} \end{aligned} \right\} \dots\dots (4.60)$$

where, ϵ_r : Radial clearance (mm)
 F_r : Radial load (N), {kgf}
 Z : Number of rolling elements
 i : No. of rows of rolling elements
 D_w : Ball diameter (mm)
 L_{we} : Effective roller length (mm)
 L_ε : Life with clearance of ϵ_r
 L : Life with zero clearance, obtained from Equation (4.57)

The relationship between load factor ϵ and $f(\epsilon)$, and the life ratio L_ϵ / L , when the radial internal clearance is ϵ_r can also be obtained as shown in Table 4.13.

Fig. 4.30 shows the relationship between the radial clearance and bearing fatigue life while taking 6208 and NU208 as examples.

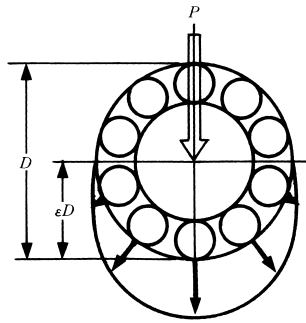

Fig. 4.29 Load Distribution with $\epsilon=0.5$

Table 4.13 ϵ and $f(\epsilon)$, L_ϵ/L

ϵ	Deep groove ball bearing		Cylindrical roller bearing	
	$f(\epsilon)$	$\frac{L_\epsilon}{L}$	$f(\epsilon)$	$\frac{L_\epsilon}{L}$
0.1	33.713	0.294	51.315	0.220
0.2	10.221	0.546	14.500	0.469
0.3	4.045	0.737	5.539	0.691
0.4	1.408	0.889	1.887	0.870
0.5	0	1.0	0	1.0
0.6	-0.859	1.069	-1.133	1.075
0.7	-1.438	1.098	-1.897	1.096
0.8	-1.862	1.094	-2.455	1.065
0.9	-2.195	1.041	-2.929	0.968
1.0	-2.489	0.948	-3.453	0.805
1.25	-3.207	0.605	-4.934	0.378
1.5	-3.877	0.371	-6.387	0.196
1.67	-4.283	0.276	-7.335	0.133
1.8	-4.596	0.221	-8.082	0.100
2.0	-5.052	0.159	-9.187	0.067
2.5	-6.114	0.078	-11.904	0.029
3	-7.092	0.043	-14.570	0.015
4	-8.874	0.017	-19.721	0.005
5	-10.489	0.008	-24.903	0.002
10	-17.148	0.001	-48.395	0.0002

4

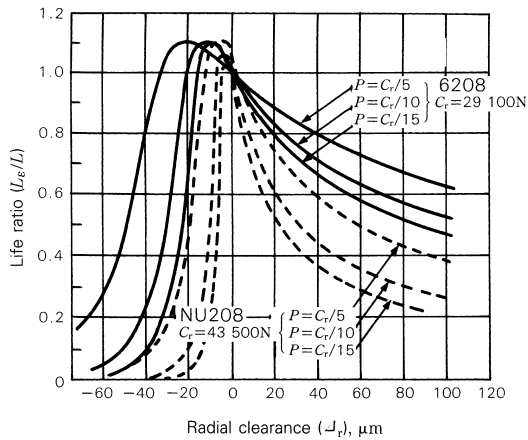

Fig. 4.30 Radial Clearance and Bearing Life Ratio

Selection of Bearing Size

4.8.3 Misalignment of Inner/Outer Rings and Fatigue Life of Deep-Groove Ball Bearings

A rolling bearing is manufactured with high accuracy, and it is essential to take utmost care with machining and assembly accuracies of surrounding shafts and housing if this accuracy is to be maintained. In practice, however, the machining accuracy of parts around the bearing is limited, and bearings are subject to misalignment of inner/outer rings caused by the shaft deflection under external load.

The allowable misalignment is generally 0.0006~0.003 rad ($2'$ to $10'$) but this varies depending on the size of the deep-groove ball bearing, internal clearance during operation, and load. This section introduces the relationship between the misalignment of inner/outer rings and fatigue life. Four different sizes of bearings are selected as examples from the 62 and 63 series deep-groove ball bearings. Assume the fatigue life without misalignment as $L_{\theta=0}$ and the fatigue life with misalignment as L_{θ} . The effect of the misalignment on the fatigue life may be found by calculating $L_{\theta}/L_{\theta=0}$. The result is shown in Figs. 4.31 to 4.34. As an example of ordinary running conditions, the radial load F_r (N) {kgf} and axial load F_a (N) {kgf} were assumed respectively to be approximately 10%

normal load) and 1% (light preload) of the dynamic load rating C_r (N) {kgf} of a bearing and were used as load conditions for the calculation. Normal radial clearance was used and the shaft fit was set to around j5. Also taken into account was the decrease of the internal clearance due to expansion of the inner ring. Moreover, assuming that the temperature difference between the inner and outer rings was 5°C during operation, inner/outer ring misalignment, $L_{\theta}/L_{\theta=0}$ was calculated for the maximum, minimum, and mean effective clearances. As shown in Figs. 4.31 to 4.34, degradation of the fatigue life is limited to 5 to 10% or less when the misalignment ranges from 0.0006 to 0.003 rad ($2'$ to $10'$), thus not presenting much problem. When the misalignment exceeds a certain limit, however, the fatigue life degrades rapidly as shown in the figure. Attention is therefore necessary in this respect. When the clearance is small, not much effect is observed as long as the misalignment is small, as shown in the figure. But the life decreases substantially when the misalignment increases. As previously mentioned, it is essential to minimize the mounting error as much as possible when a bearing is to be used.

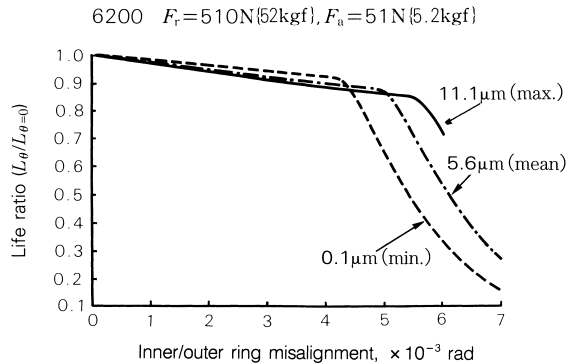

Fig. 4.31

6202 $F_r=765\text{N}\{78\text{kgf}\}$, $F_a=76.5\text{N}\{7.8\text{kgf}\}$

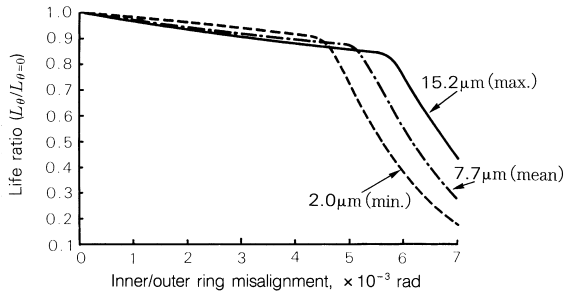

Fig. 4.32

6300 $F_r=809\text{N}\{82.5\text{kgf}\}$, $F_a=80.9\text{N}\{8.25\text{kgf}\}$

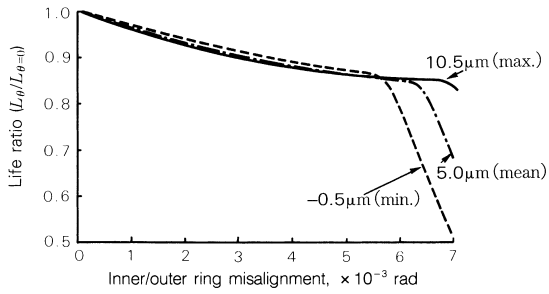

Fig. 4.33

6302 $F_r=1\,147\text{N}\{117\text{kgf}\}$, $F_a=114.7\text{N}\{11.7\text{kgf}\}$

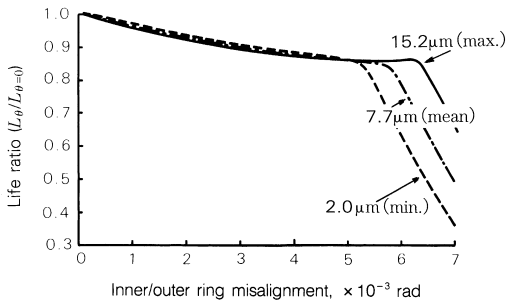

Fig. 4.34

Selection of Bearing Size

4.8.4 Misalignment of Inner/Outer Rings and Fatigue Life of Cylindrical Roller Bearings

When a shaft supported by rolling bearings is deflected or there is some inaccuracy in a shoulder, there arises misalignment between the inner and outer rings of the bearings, thereby lowering their fatigue life. The degree of life degradation depends on the bearing type and interior design but also varies depending on the radial internal clearance and the magnitude of load during operation. The relationship between the misalignment of inner/outer rings and fatigue life was determined, as shown in Figs. 4.35 to 4.38, while using cylindrical roller bearings NU215 and NU315 of standard design. In these figures, the horizontal axis shows the misalignment of inner/outer rings (rad) while the vertical axis shows the fatigue life ratio $L_{\theta}/L_{\theta=0}$. The fatigue life without misalignment is $L_{\theta=0}$ and that with misalignment is L_{θ} .

Figs. 4.35 and 4.36 show the case with constant load (10% of basic dynamic load rating C_r of a bearing) for each case when the internal clearance is a normal, C3 clearance, or C4 clearance. Figs. 4.37 and 4.38 show the case with constant clearance (normal clearance) when the load is 5%, 10%, and 20% of the basic dynamic load rating C_r . Note that the median effective clearance in these examples was determined using m5/H7 fits and a temperature difference of 5°C between the inner and outer rings. The fatigue life ratio for the clearance and load shows the same trend as in the case of other cylindrical roller bearings. But the life ratio itself differs among bearing series and dimensions, with life degradation rapid in 22 and 23 series bearings (wide type). It is advisable to use a bearing of special design when considerable misalignment is expected during application.

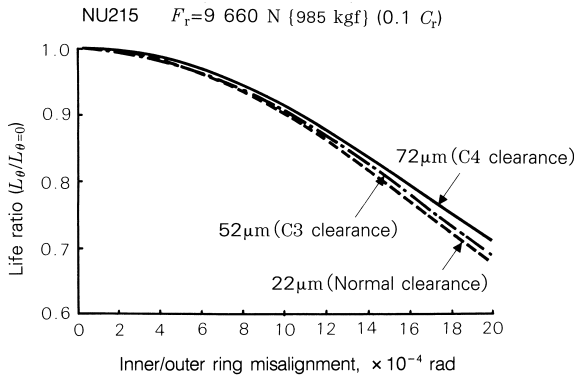

Fig. 4.35

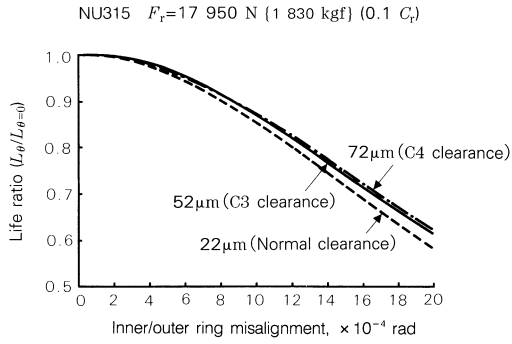

Fig. 4.36

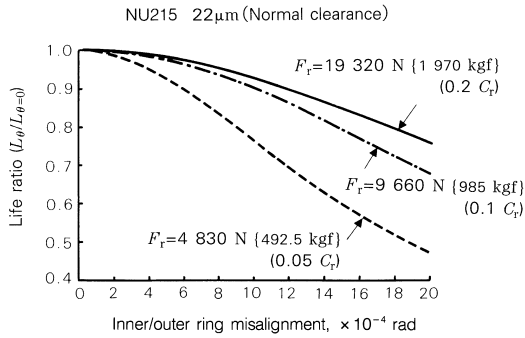

Fig. 4.37

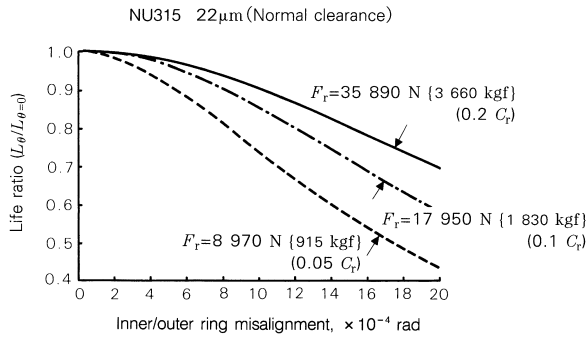

Fig. 4.38

Selection of Bearing Size

4.8.5 Oil Film Parameters and Rolling Fatigue Life

Based on numerous experiments and experiences, the rolling fatigue life of rolling bearings can be shown to be closely related to the lubrication. The rolling fatigue life is expressed by the maximum number of rotations, which a bearing can endure, until the raceway or rolling surface of a bearing develops fatigue in the material, resulting in flaking of the surface, under action of cyclic stress by the bearing.

Such flaking begins with either microscopic nonuniform portions (such as non-metallic inclusions, cavities) in the material or with microscopic defect in the material's surface (such as extremely small cracks or surface damage or dents caused by contact between extremely small projections in the raceway or rolling surface). The former flaking is called sub-surface originating flaking while the latter is surface-originating flaking.

The oil film parameter (λ), which is the ratio between the resultant oil film thickness and surface roughness, expresses whether or not the lubrication state of the rolling contact surface is satisfactory. The effect of the oil film grows with increasing λ . Namely, when λ is large (around 3 in general), surface-originating flaking due to contact between extremely small projections in the surface is less likely to occur. If the surface is free from defects (flaw, dent, etc.), the life is determined mainly by sub-surface originating flaking. On the other hand, a decrease in λ tends to develop surface-originating flaking, resulting in degradation of the bearing's life. This state is shown in Fig. 4.39.

NSK has performed life experiments with about 370 bearings within the range of $\lambda = 0.3 \sim 3$ using different lubricants and bearing materials (**A** and **B** in Fig. 4.40). Fig. 4.40 shows a summary of the principal experiments selected from among those reported up to now. As is evident, the life decreases rapidly at around $\lambda = 1$ when compared with the life values at around $\lambda = 3 \sim 4$ where life changes at a slower rate. The life becomes about 1/10 or less at $\lambda = 0.5$. This is a result of severe surface-originating flaking. Accordingly, it is advisable for extension of the fatigue life of rolling bearings to increase the oil film parameter (ideally to a value above 3) by improving lubrication conditions.

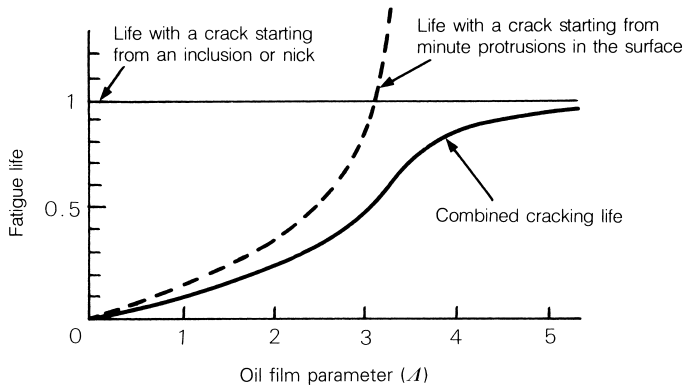

Fig. 4.39 Expression of Life According to A (Tallian, et al.)

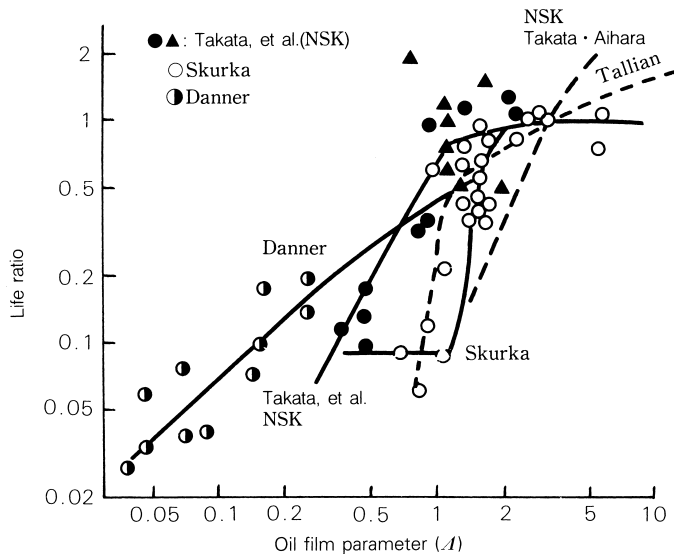

Fig. 4.40 Typical Experiment with A and Rolling Fatigue Life (Expressed with reference to the life at $A=3$)

Selection of Bearing Size

4.8.6 EHL Oil Film Parameter Calculation Diagram

Lubrication of rolling bearings can be expressed by the theory of elastohydrodynamic lubrication (EHL). Introduced below is a method to determine the oil film parameter (oil film – surface roughness ratio), the most critical among the EHL qualities.

(1) Oil Film Parameter

The raceway surfaces and rolling surfaces of a bearing are extremely smooth, but have fine irregularities when viewed through a microscope. As the EHL oil film thickness is in the same order as the surface roughness, lubricating conditions cannot be discussed without considering this surface roughness. For example, given a particular mean oil film thickness, there are two conditions which may occur depending on the surface roughness. One consists of complete separation of the two surfaces by means of the oil film (Fig. 4.41 (a)). The other consists of metal contact between surface projections (Fig. 4.41 (b)). The degradation of lubrication and surface damage is attributed to case (b). The symbol lambda (λ) represents the ratio between the oil film thickness and roughness. It is widely employed as an oil film parameter in the study and application of EHL.

$$\lambda = h/\sigma \dots\dots\dots (4.61)$$

where h : EHL oil film thickness
 σ : Combined roughness ($\sqrt{\sigma_1^2 + \sigma_2^2}$)

σ_1, σ_2 : Root mean square (rms) roughness of each contacting surface

The oil film parameter may be correlated to the formation of the oil film as shown in Figs. 4.42 and the degree of lubrication can be divided into three zones as shown in the figure.

(2) Oil Film Parameter Calculation Diagram

The **Dowson-Higginson** minimum oil film thickness equation shown below is used for the diagram:

$$H_{\min} = 2.65 \frac{G^{0.54} U^{0.7}}{W^{0.13}} \dots\dots\dots (4.62)$$

The oil film thickness to be used is that of the inner ring under the maximum rolling element load (at which the thickness becomes minimum).

Equation (4.61) can be expressed as follows by grouping into terms (R) for speed, (A) for viscosity, (F) for load, and (J) for bearing technical specifications. t is a constant.

$$\lambda = t \cdot R \cdot F \cdot J \dots\dots\dots (4.63)$$

R and A may be quantities not dependent on a bearing. When the load P is assumed to be between 98 N {10 kgf} and 98 kN {10 tf}, F changes by 2.54 times as $F \propto P^{-0.13}$. Since the actual load is determined roughly from the bearing size, however, such change may be limited to 20 to 30%. As a result, F is handled as a lump with the term J of bearing specifications [$F=F(J)$]. Traditional Equation (4.62) can therefore be grouped as shown below:

$$\lambda = T \cdot R \cdot A \cdot D \dots\dots\dots (4.64)$$

where, T : Factor determined by the bearing Type
 R : Factor related to Rotation speed
 A : Factor related to viscosity (viscosity grade α : Alpha)
 D : Factor related to bearing Dimensions

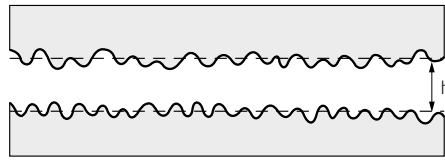

(a) Good roughness

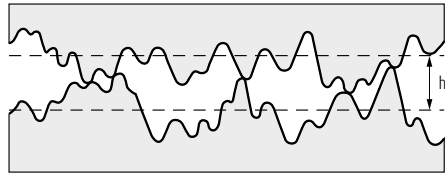

(b) High roughness

Fig. 4.41 Oil Film and Surface Roughness

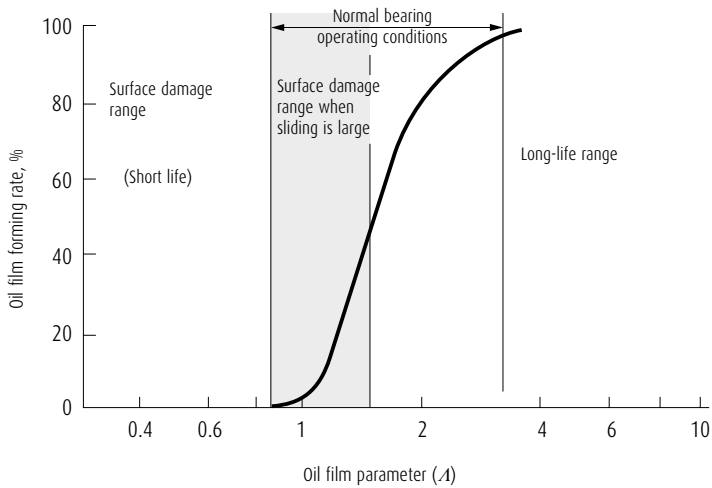

Fig. 4.42 Effect of Oil Film on Bearing Performance

Selection of Bearing Size

The oil film parameter \mathcal{A} , which is most vital among quantities related to EHL, is expressed by a simplified equation shown below. The fatigue life of rolling bearings becomes shorter when \mathcal{A} is smaller. In the equation $\mathcal{A} = T \cdot R \cdot A \cdot D$ terms include A for oil viscosity η_0 (mPa·s, {cp}), R for the speed n (min^{-1}), and D for bearing bore diameter d (mm). The calculation procedure is described below.

- (i) Determine the value T from the bearing type (Table 4.14).
- (ii) Determine the R value for n (min^{-1}) from Fig. 4.43.
- (iii) Determine A from the absolute viscosity (mPa·s, {cp}) and oil kind in Fig. 4.44.

Generally, the kinematic viscosity ν_0 (mm^2/s , {cSt}) is used and conversion is made as follows:

$$\eta_0 = \rho \cdot \nu_0 \quad \text{.....(4.65)}$$

ρ is the density (g/cm^3) and uses the approximate value as shown below:

- Mineral oil $\rho = 0.85$
- Silicon oil $\rho = 1.0$
- Diester oil $\rho = 0.9$

When it is not known whether the mineral oil is naphthene or paraffin, use the paraffin curve shown in Fig. 4.44.

- (iv) Determine the D value from the diameter series and bore diameter d (mm) in Fig. 4.45.
- (v) The product of the above values is used as an oil film parameter.

Table 4.14 Value T

Bearing type	Value T
Ball bearing	1.5
Cylindrical roller bearing	1.0
Tapered roller bearing	1.1
Spherical roller bearing	0.8

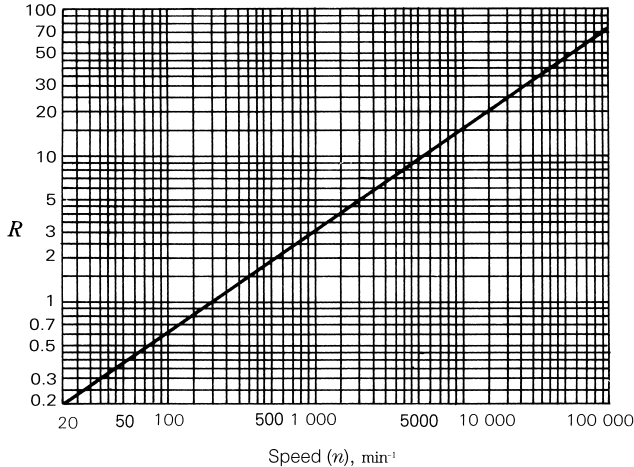

Fig. 4.43 Speed Term, R

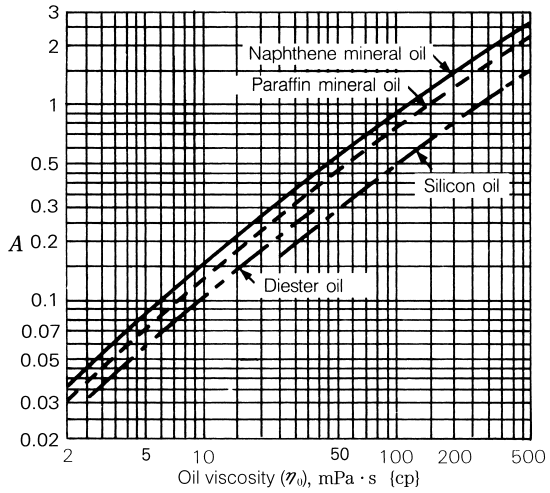

Fig. 4.44 Term Related to Lubricant Viscosity, A

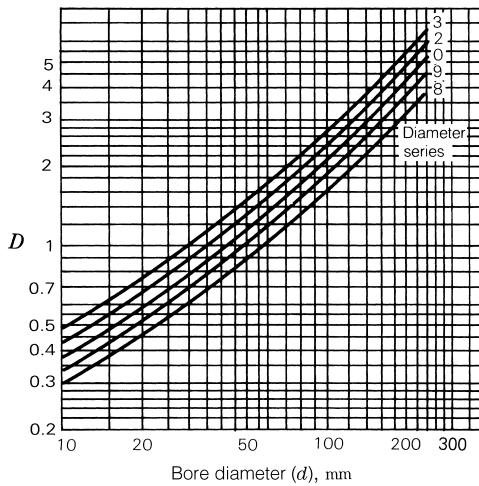

Fig. 4.45 Term Related to Bearing Specifications, D

Selection of Bearing Size

Examples of EHL oil film parameter calculation are described below.

(Example 1)

The oil film parameter is determined when a deep groove ball bearing 6312 is operated with paraffin mineral oil ($\eta_0 = 30 \text{ mPa} \cdot \text{s}$, {cp}) at the speed $n = 1\,000 \text{ min}^{-1}$.

(Solution)

$d = 60 \text{ mm}$ and $D = 130 \text{ mm}$ from the bearing catalog.
 $T = 1.5$ from Table 4.18
 $R = 3.0$ from Fig. 4.43
 $A = 0.31$ from Fig. 4.44
 $D = 1.76$ from Fig. 4.45
 Accordingly, $\lambda = 2.5$

(Example 2)

The oil film parameter is determined when a cylindrical roller bearing NU240 is operated with paraffin mineral oil ($\eta_0 = 10 \text{ mPa} \cdot \text{s}$, {cp}) at the speed $n = 2\,500 \text{ min}^{-1}$.

(Solution)

$d = 200 \text{ mm}$ and $D = 360 \text{ mm}$ from the bearing catalog.
 $T = 1.0$ from Table 4.18
 $R = 5.7$ from Fig. 4.43
 $A = 0.13$ from Fig. 4.44
 $D = 4.8$ from Fig. 4.45
 Accordingly, $\lambda = 3.6$

(3) Effect of Oil Shortage and Shearing Heat Generation

The oil film parameter obtained above is the value when the requirements, that is, the contact inlet fully flooded with oil and isothermal inlet are satisfied. However, these conditions may not be satisfied depending on lubrication and operating conditions. One such condition is called starvation, and the actual oil film parameter value may become smaller than determined by Equation (4.64). Starvation might occur if lubrication becomes limited. In this condition, a guideline for adjusting the oil film parameter is 50 to 70% of the value obtained from Equation (4.64).

Another effect is the localized temperature rise of oil in the contact inlet due to heavy shearing during highspeed operation, resulting in a decrease of the oil viscosity. In this case, the oil film parameter becomes smaller than the isothermal theoretical value. The effect of shearing heat generation was analyzed by Murch and Wilson, who established the decrease factor of the oil film parameter. An approximation using the viscosity and speed (pitch diameter of rolling element set $D_{pw} \times$ rotating speed per minute n as parameters) is shown in Fig. 4.46. By multiplying the oil film parameter determined in the previous section by this decrease factor H_i the oil film parameter considering the shearing heat generation is obtained.

Namely;

$$\lambda = H_i \cdot T \cdot R \cdot A \cdot D \dots\dots\dots(4.66)$$

Note that the average of the bore and outside diameters of the bearings may be used as the pitch diameter D_{pw} (d_m) of rolling element set.

Conditions for the calculation (Example 1) include $d_m n = 9.5 \times 10^4$ and $\eta_0 = 30 \text{ mPa} \cdot \text{s}$, {cp}, and H_i is nearly equivalent to 1 as is evident from Fig. 4.46. There is therefore almost no effect of shearing heat generation. Conditions for (Example 2) are $d_m n = 7 \times 10^5$ and $\eta_0 = 10 \text{ mPa} \cdot \text{s}$, {cp} while $H_i = 0.76$, which means that the oil film parameter is smaller by about 25%. Accordingly, λ is actually 2.7, not 3.6.

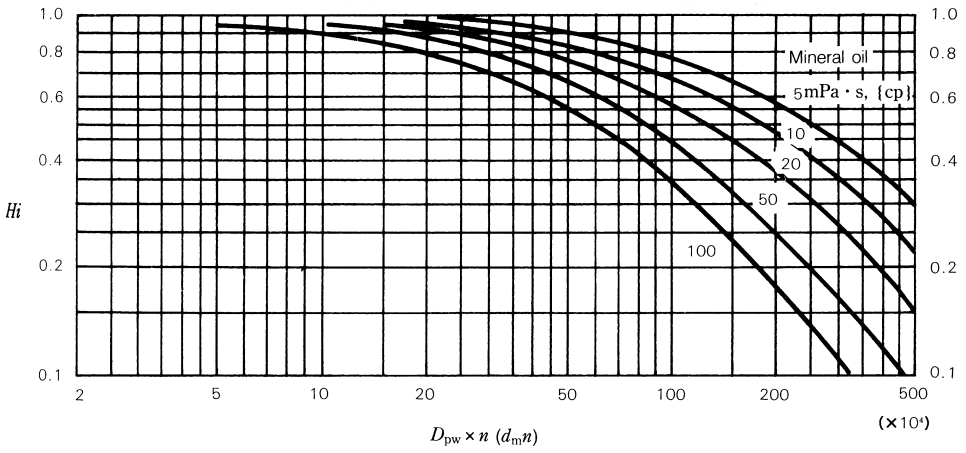

Fig. 4.46 Oil film thickness decrease factor H_i due to shearing heat generation

Selection of Bearing Size

4.8.7 Load Calculation of Gears

(1) Calculation of Loads on Spur, Helical, and Double-Helical Gears

There is an extremely close relationship among the two mechanical elements, gears and rolling bearings. Gear units, which are widely used in machines, are almost always used with bearings. Rating life calculation and selection of bearings to be used in gear units are based on the load at the gear meshing point. The load at the gear meshing point is calculated as follows:

Spur Gear:

$$P_1 = P_2 = \frac{9\,550\,000H}{n_1 \left(\frac{d_{p1}}{2}\right)} = \frac{9\,550\,000H}{n_2 \left(\frac{d_{p2}}{2}\right)} \dots\dots\dots (N)$$

$$= \frac{974\,000H}{n_1 \left(\frac{d_{p1}}{2}\right)} = \frac{974\,000H}{n_2 \left(\frac{d_{p2}}{2}\right)} \dots\dots \{kgf\}$$

$$S_1 = S_2 = P_1 \tan \alpha$$

The magnitudes of the forces P_2 and S_2 applied to the driven gear are the same as P_1 and S_1 respectively, but the direction is opposite.

Helical Gear:

$$P_1 = P_2 = \frac{9\,550\,000H}{n_1 \left(\frac{d_{p1}}{2}\right)} = \frac{9\,550\,000H}{n_2 \left(\frac{d_{p2}}{2}\right)} \dots\dots\dots (N)$$

$$= \frac{974\,000H}{n_1 \left(\frac{d_{p1}}{2}\right)} = \frac{974\,000H}{n_2 \left(\frac{d_{p2}}{2}\right)} \dots\dots \{kgf\}$$

$$S_1 = S_2 = \frac{P_1 \tan \alpha_n}{\cos \beta}$$

$$T_1 = T_2 = P_1 \tan \beta$$

The magnitudes of the forces P_2 , S_2 , and T_2 applied to the driven gear are the same as P_1 , S_1 , and T_1 respectively, but the direction is opposite.

Double-Helical Gear:

$$P_1 = P_2 = \frac{9\,550\,000H}{n_1 \left(\frac{d_{p1}}{2}\right)} = \frac{9\,550\,000H}{n_2 \left(\frac{d_{p2}}{2}\right)} \dots\dots\dots (N)$$

$$= \frac{974\,000H}{n_1 \left(\frac{d_{p1}}{2}\right)} = \frac{974\,000H}{n_2 \left(\frac{d_{p2}}{2}\right)} \dots\dots \{kgf\}$$

$$S_1 = S_2 = \frac{P_1 \tan \alpha_n}{\cos \beta}$$

- where, P : Tangential force (N), {kgf}
 S : Separating force (N), {kgf}
 T : Thrust (N), {kgf}
 H : Transmitted power (kW)
 n : Speed (min^{-1})
 d_p : Pitch diameter (mm)
 a : Gear pressure angle
 α_n : Gear normal pressure angle
 β : Twist angle

- Subscript 1: Driving gear
 Subscript 2: Driven gear

In the case of double-helical gears, thrust of the helical gears offsets each other and thus only tangential and separating forces act. For the directions of tangential, separating, and thrust forces, please refer to Figs. 4.47 and 4.48.

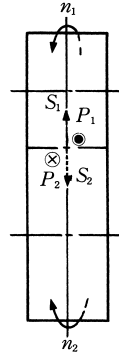
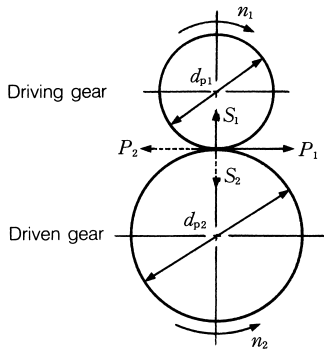

- Vertical upward on paper
- ⊗ Vertical downward on paper

Fig. 4.47 Spur Gear

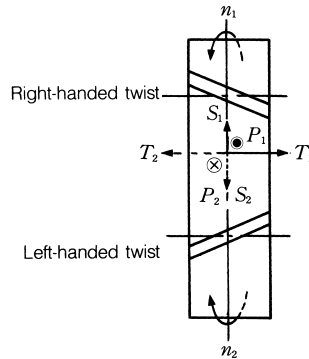
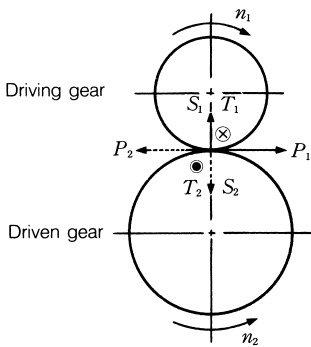

- Vertical upward on paper
- ⊗ Vertical downward on paper

Fig. 4.48 Helical Gear

Selection of Bearing Size

The thrust direction of the helical gear varies depending on the gear running direction, the gear twist direction, and whether the gear is driving or driven. The directions are as follows:
The force on the bearing is determined as follows:
Tangential force:

$$P_1 = P_2 = \frac{9\,550\,000H}{n_1 \left(\frac{d_{p1}}{2}\right)} = \frac{9\,550\,000H}{n_2 \left(\frac{d_{p2}}{2}\right)} \dots\dots\dots (\text{N})$$

$$= \frac{974\,000H}{n_1 \left(\frac{d_{p1}}{2}\right)} = \frac{974\,000H}{n_2 \left(\frac{d_{p2}}{2}\right)} \dots\dots \text{(kgf)}$$

Separating force: $S_1 = S_2 = P_1 \frac{\tan\alpha_n}{\cos\beta}$

Thrust: $T_1 = T_2 = P_1 \cdot \tan\beta$

The same method can be applied to bearings C and D.

Table 4.15

Load classification		Bearing A	Bearing B
Radial load	From P_1	$P_A = \frac{b}{a+b} P_1 \otimes$	$P_B = \frac{a}{a+b} P_1 \otimes$
	From S_1	$S_A = \frac{b}{a+b} S_1 \uparrow$	$S_B = \frac{a}{a+b} S_1 \uparrow$
	From T_1	$U_A = \frac{d_{p1}/2}{a+b} T_1 \uparrow$	$U_B = \frac{d_{p1}/2}{a+b} T_1 \downarrow$
Combined radial load		$F_{rA} = \sqrt{P_A^2 + (S_A + U_A)^2}$	$F_{rB} = \sqrt{P_B^2 + (S_B + U_B)^2}$
Axial load		$F_a = T_1 \leftarrow$	

Load direction is shown referring to left side of Fig. 4.49.

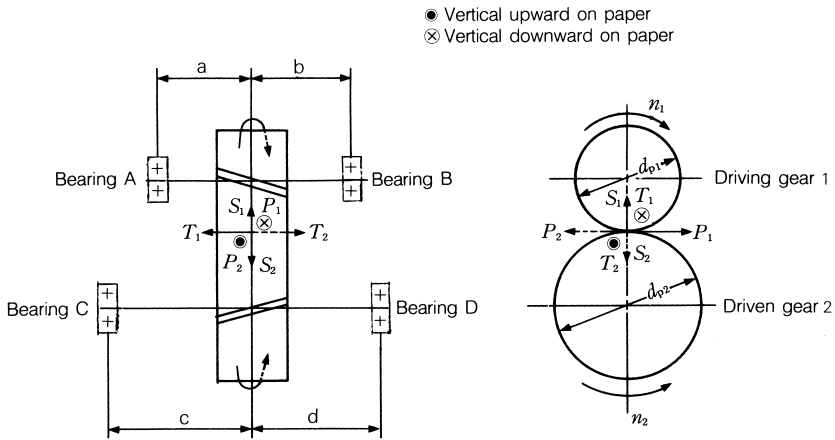

Fig. 4.49

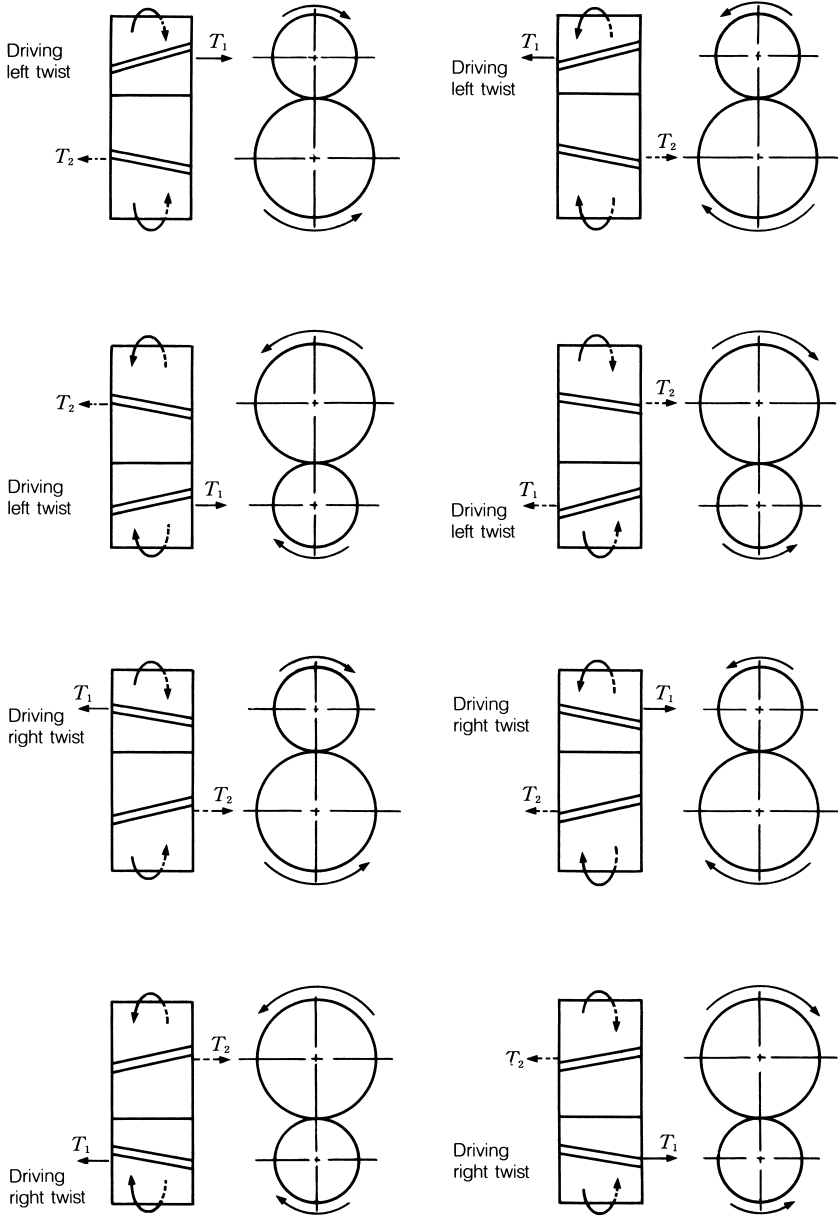

Fig. 4.50 Thrust Direction

Selection of Bearing Size

(2) Calculation of Load Acting on Straight Bevel Gears

The load at the meshing point of straight bevel gears is calculated as follows:

$$P_1 = P_2 = \frac{9\,550\,000H}{n_1 \left(\frac{D_{m1}}{2}\right)} = \frac{9\,550\,000H}{n_1 \left(\frac{D_{m2}}{2}\right)} \dots\dots\dots (N)$$

$$= \frac{974\,000H}{n_1 \left(\frac{D_{m1}}{2}\right)} = \frac{974\,000H}{n_2 \left(\frac{D_{m2}}{2}\right)} \dots\dots \{kgf\}$$

$$D_{m1} = d_{p1} - w \sin \delta_1$$

$$D_{m2} = d_{p2} - w \sin \delta_2$$

$$S_1 = P_1 \tan \alpha_n \cos \delta_1$$

$$S_2 = P_2 \tan \alpha_n \cos \delta_2$$

$$T_1 = P_1 \tan \alpha_n \cos \delta_1$$

$$T_2 = P_2 \tan \alpha_n \cos \delta_2$$

where, D_m : Average pitch diameter (mm)
 d_p : Pitch diameter (mm)
 w : Gear width (pitch line length) (mm)
 α_n : Gear normal pressure angle
 δ : Pitch cone angle

Generally, $\delta_1 + \delta_2 = 90^\circ$. In this case, S_1 and T_2 (or S_2 and T_1) are the same in magnitude but opposite in direction. S/P and T/P for δ are shown in Fig. 4.53. The load on the bearing can be calculated as shown below.

Table 4.16

● Vertical upward on paper
 ⊗ Vertical downward on paper

Load classification		Bearing A	Bearing B	Bearing C	Bearing D
Radial load	From P_1	$P_A = \frac{b}{a} P_1$ ●	$P_B = \frac{a+b}{a} P_1$ ⊗	$P_C = \frac{d}{c+d} P_2$ ●	$P_D = \frac{c}{c+d} P_2$ ●
	From S_1	$S_A = \frac{b}{a} S_1$ ↓	$S_B = \frac{a+b}{a} S_1$ ↑	$S_C = \frac{d}{c+d} S_2$ →	$S_D = \frac{c}{c+d} S_2$ →
	From T_1	$U_A = \frac{D_{m1}}{2 \cdot a} T_1$ ↑	$U_B = \frac{D_{m1}}{2 \cdot a} T_1$ ↓	$U_C = \frac{D_{m2}}{2(c+d)} T_2$ ←	$U_D = \frac{D_{m2}}{2(c+d)} T_2$ ←
Combined radial load		$F_{rA} = \sqrt{P_A^2 + (S_A + U_A)^2}$	$F_{rB} = \sqrt{P_B^2 + (S_B + U_B)^2}$	$F_{rC} = \sqrt{P_C^2 + (S_C + U_C)^2}$	$F_{rD} = \sqrt{P_D^2 + (S_D + U_D)^2}$
Axial load		$F_a = T_1$		$F_a = T_2$	

Load direction is shown referring to Fig. 4.52.

Driving Gear
(counterclockwise as
viewed from the opposite
side of the cone crest)

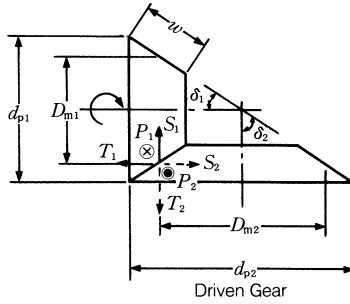

Fig. 4.51

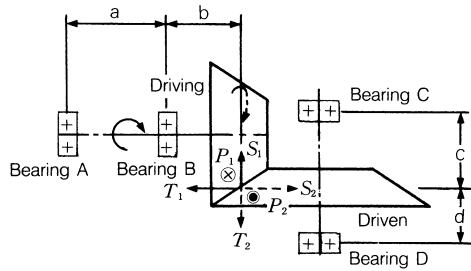

Fig. 4.52

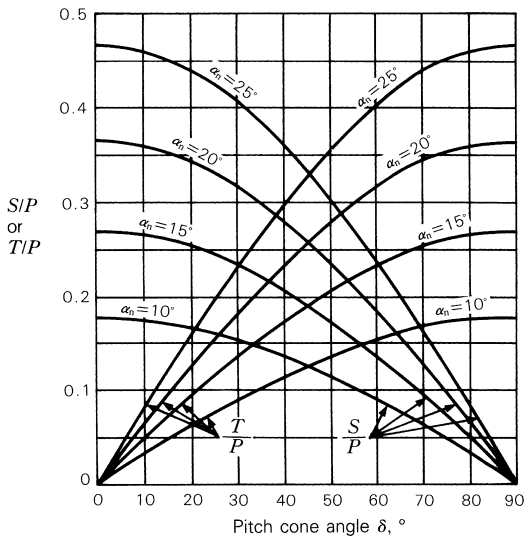

Fig. 4.53

Selection of Bearing Size

(3) Calculation of Load on Spiral Bevel Gears

In the case of spiral bevel gears, the magnitude and direction of loads at the meshing point vary depending on the running direction and gear twist direction. The running is either clockwise or counterclockwise as viewed from the side opposite of the gears (Fig. 4.54). The gear twist direction is classified as shown in Fig. 4.55. The force at the meshing point is calculated as follows:

$$P_1 = P_2 = \frac{9\,550\,000H}{n_1 \left(\frac{D_{m1}}{2}\right)} = \frac{9\,550\,000H}{n_2 \left(\frac{D_{m2}}{2}\right)} \dots\dots\dots \text{(N)}$$

$$= \frac{974\,000H}{n_1 \left(\frac{D_{m1}}{2}\right)} = \frac{974\,000H}{n_2 \left(\frac{D_{m2}}{2}\right)} \dots\dots\dots \text{(kgf)}$$

- where, α_n : Gear normal pressure angle
- β : Twisting angle
- δ : Pitch cone angle
- w : Gear width (mm)
- D_m : Average pitch diameter (mm)
- d_p : Pitch diameter (mm)

Note that the following applies:

$$D_{m1} = d_{p1} - w \sin \delta_1$$

$$D_{m2} = d_{p2} - w \sin \delta_2$$

The separating force S and T are as follows depending on the running direction and gear twist direction:

(i) Clockwise with right twisting or counterclockwise with left twisting

Driving Gear
Separating Force

$$S_1 = \frac{P}{\cos \beta} (\tan \alpha_n \cos \delta_1 + \sin \beta \sin \delta_1)$$

Thrust

$$T_1 = \frac{P}{\cos \beta} (\tan \alpha_n \sin \delta_1 - \sin \beta \cos \delta_1)$$

Driven Gear
Separating Force

$$S_2 = \frac{P}{\cos \beta} (\tan \alpha_n \cos \delta_2 + \sin \beta \sin \delta_2)$$

Thrust

$$T_2 = \frac{P}{\cos \beta} (\tan \alpha_n \sin \delta_2 - \sin \beta \cos \delta_2)$$

(ii) Clockwise with Right Twisting or Counterclockwise with Left Twisting

Driving Gear
Separating Force

$$S_1 = \frac{P}{\cos \beta} (\tan \alpha_n \cos \delta_1 + \sin \beta \sin \delta_1)$$

Thrust

$$T_1 = \frac{P}{\cos \beta} (\tan \alpha_n \sin \delta_1 - \sin \beta \cos \delta_1)$$

Driven Gear
Separating Force

$$S_2 = \frac{P}{\cos \beta} (\tan \alpha_n \cos \delta_2 + \sin \beta \sin \delta_2)$$

Thrust

$$T_2 = \frac{P}{\cos \beta} (\tan \alpha_n \sin \delta_2 - \sin \beta \cos \delta_2)$$

The positive (plus) calculation result means that the load is acting in a direction to separate the gears while a negative (minus) one means that the load is acting in a direction to bring the gears nearer. Generally, $\delta_1 + \delta_2 = 90^\circ$. In this case, T_1 and S_2 (S_1 and T_2) are the same in magnitude but opposite in direction. The load on the bearing can be calculated by the same method as described in Section 4.8.7 (2), "Calculation of Load Acting on Straight Bevel Gears."

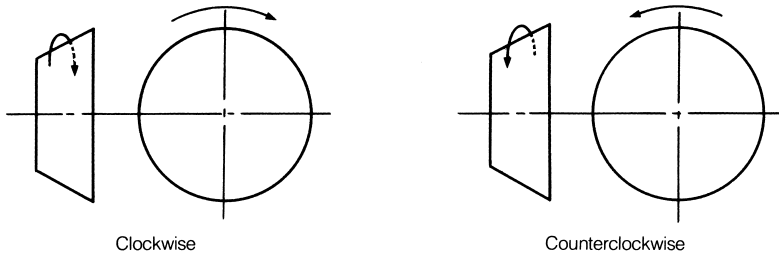

Fig. 4.54

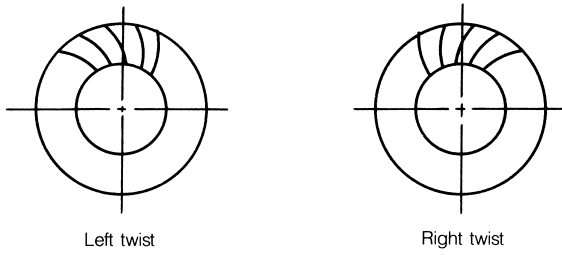

Fig. 4.55

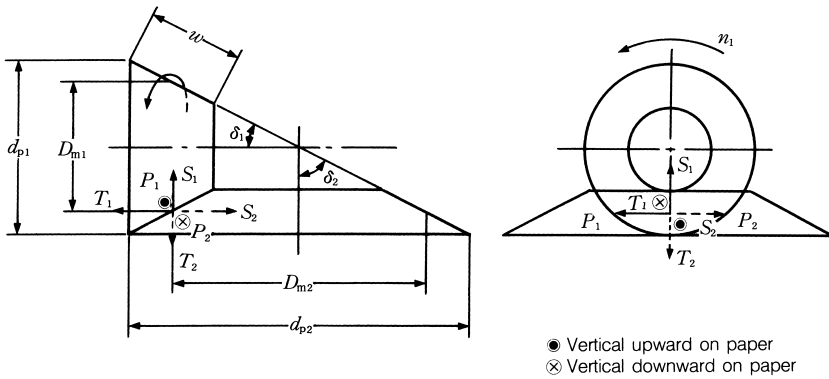

Fig. 4.56

Selection of Bearing Size

(4) Calculation of Load Acting on Hypoid Gears

The force acting at the meshing point of hypoid gears is calculated as follows:

$$P_1 = \frac{9\,550\,000H}{n_1 \left(\frac{D_{m1}}{2}\right)} = \frac{\cos\beta_1}{\cos\beta_2} P_2 \dots\dots\dots (N)$$

$$= \frac{974\,000H}{n_1 \left(\frac{D_{m1}}{2}\right)} = \frac{\cos\beta_1}{\cos\beta_2} P_2 \dots\dots\dots \{kgf\}$$

$$P_2 = \frac{9\,550\,000H}{n_2 \left(\frac{D_{m2}}{2}\right)} \dots\dots\dots (N)$$

$$= \frac{974\,000H}{n_2 \left(\frac{D_{m2}}{2}\right)} \dots\dots\dots \{kgf\}$$

$$D_{m1} = D_{m2} \frac{z_1}{z_2} \cdot \frac{\cos\beta_1}{\cos\beta_2}$$

$$D_{m2} = d_{p2} - w_2 \sin\delta_2$$

where, α_n : Gear normal pressure angle

β : Twisting angle

δ : Pitch cone angle

w : Gear width (mm)

D_m : Average pitch diameter (mm)

d_p : Pitch diameter (mm)

z : Number of teeth

Note that the following applies:

$$D_{m1} = d_{p1} - w \sin\delta_1$$

$$D_{m2} = d_{p2} - w \sin\delta_2$$

The separating force S and T are as follows depending on the running direction and gear twist direction:

(i) Clockwise with right twisting or counterclockwise with left twisting

Driving Gear

Separating Force

$$S_1 = \frac{P_1}{\cos\beta} (\tan\alpha_n \cos\delta_1 + \sin\beta \sin\delta_1)$$

Thrust

$$T_1 = \frac{P_1}{\cos\beta} (\tan\alpha_n \sin\delta_1 - \sin\beta \cos\delta_1)$$

Driven Gear

Separating Force

$$S_2 = \frac{P_2}{\cos\beta} (\tan\alpha_n \cos\delta_2 + \sin\beta \sin\delta_2)$$

Thrust

$$T_2 = \frac{P_2}{\cos\beta} (\tan\alpha_n \sin\delta_2 - \sin\beta \cos\delta_2)$$

(ii) Clockwise with right twisting or counterclockwise with left twisting

Driving Gear

Separating Force

$$S_1 = \frac{P_1}{\cos\beta} (\tan\alpha_n \cos\delta_1 + \sin\beta \sin\delta_1)$$

Thrust

$$T_1 = \frac{P_1}{\cos\beta} (\tan\alpha_n \sin\delta_1 - \sin\beta \cos\delta_1)$$

Driven Gear

Separating Force

$$S_2 = \frac{P_2}{\cos\beta} (\tan\alpha_n \cos\delta_2 + \sin\beta \sin\delta_2)$$

Thrust

$$T_2 = \frac{P_2}{\cos\beta} (\tan\alpha_n \sin\delta_2 - \sin\beta \cos\delta_2)$$

The positive (plus) calculation result means that the load is acting in a direction to separate the gears while a negative (minus) one means that the load is acting in a direction to bring the gears nearer. For the running direction and gear twist direction, refer to Section 4.8.7 (3), "Calculation of Load on Spiral Bevel Gears."

The load on the bearing can be calculated by the same method as described in Section 4.8.7 (2), "Calculation of Load Acting on Straight Bevel Gears."

Selection of Bearing Size

The next calculation diagram is used to determine the approximate value and direction of separating force S and thrust T .

[How To Use]

The method of determining the separating force S is shown. The thrust T can also be determined in a similar manner.

1. Take the gear normal pressure angle α_n from the vertical scale on the left side of the diagram.

2. Determine the intersection between the pitch cone angle δ and the twist angle β . Determine one point which is either above or below the $\beta = 0$ line according to the rotating direction and gear twist direction.
3. Draw a line connecting the two points and read the point at which the line cuts through the right vertical scale. This reading gives the ratio $(S/P, \%)$ of the separating force S to the tangential force P in percentage.

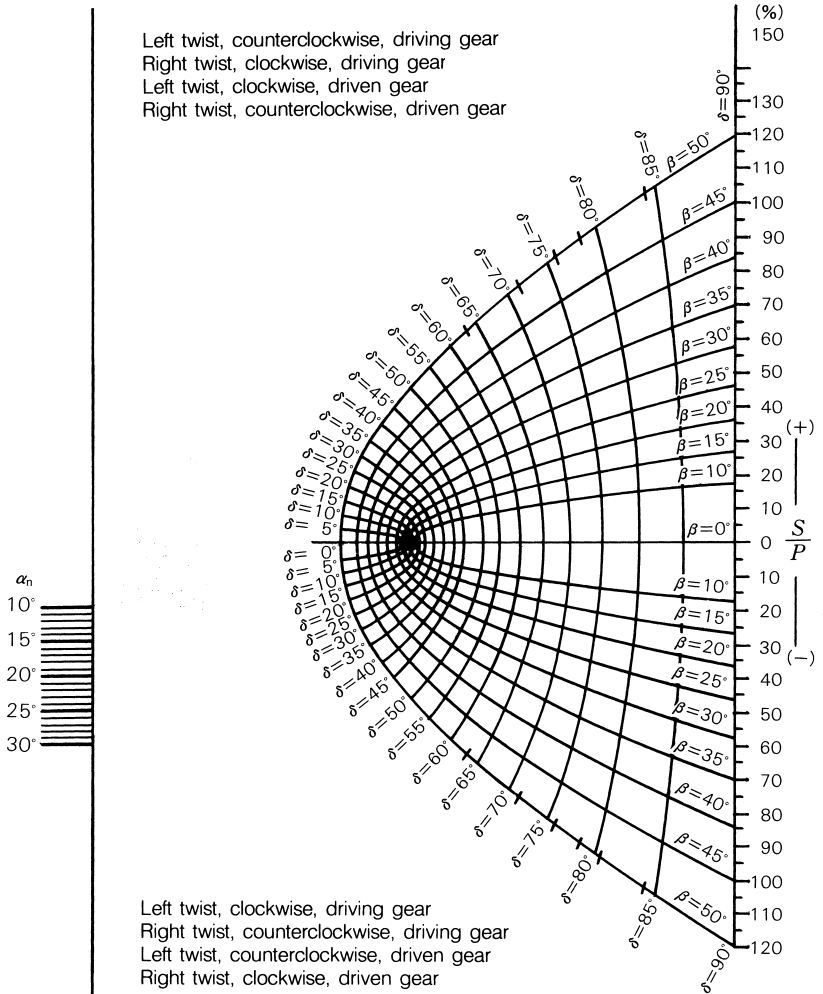

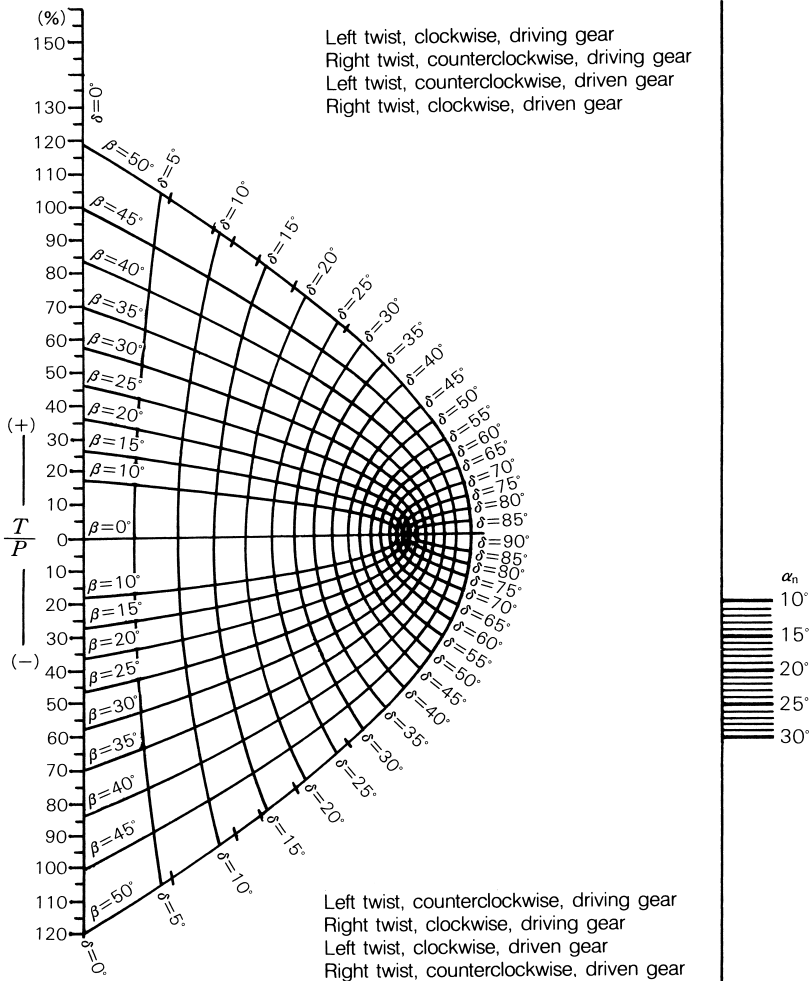

Calculation Diagram of Thrust T

Selection of Bearing Size

(5) Calculation of Load on Worm Gear

A worm gear is a kind of spigot gear, which can produce a high reduction ratio with small volume. The load at a meshing point of worm gears is calculated as shown in Table 4.17. Symbols of Table 4.17 are as follows:

i : Gear ratio $\left(i = \frac{Z_2}{Z_w} \right)$

η : Worm gear efficiency $\left[\eta = \frac{\tan \gamma}{\tan(\gamma + \psi)} \right]$

γ : Advance angle $\left(\gamma = \tan^{-1} \frac{d_{p2}}{i d_{p1}} \right)$

ψ : For the frictional angle, the value obtained

$$\text{from } V_R = \frac{\pi d_{p1} n_1}{\cos \gamma} \times \frac{10^{-3}}{60}$$

as shown in Fig. 4.57 is used.

When V_R is 0.2 m/s or less, then use $\psi = 8^\circ$.

When V_R exceeds 6 m/s, use $\psi = 1^\circ 4'$.

α_n : Gear normal pressure angle

α_s : Shaft plane pressure angle

Z_w : No. of threads (No. of teeth of worm gear)

Z_2 : No. of teeth of worm wheel

Subscript 1: For driving worm gear

Subscript 2: For driven worm gear

In a worm gear, there are four combinations of interaction at the meshing point as shown below depending on the twist directions and rotating directions of the worm gear.

The load on the bearing is obtained from the magnitude and direction of each component at the meshing point of the worm gears according to the method shown in Table 4.15 of Section 4.8.7 (1), Calculation of loads on spur, helical, and double-helical gears.

Table 4.17

Force	Worm	Worm wheel
Tangential P	$\frac{9\ 550\ 000H}{n_1 \left(\frac{d_{p1}}{2} \right)}$(N)	$\frac{9\ 550\ 000H\eta}{n_1 \left(\frac{d_{p2}}{2} \right)} = \frac{P_1 \eta}{\tan \gamma} = \frac{P_1}{\tan(\gamma + \psi)}$(N)
	$\frac{974\ 000H}{n_1 \left(\frac{d_{p1}}{2} \right)}$(kgf)	$\frac{974\ 000H\eta}{n_1 \left(\frac{d_{p2}}{2} \right)} = \frac{P_1 \eta}{\tan \gamma} = \frac{P_1}{\tan(\gamma + \psi)}$(kgf)
Thrust T	$\frac{9\ 550\ 000H\eta}{n_1 \left(\frac{d_{p2}}{2} \right)} = \frac{P_1 \eta}{\tan \gamma} = \frac{P_1}{\tan(\gamma + \psi)}$(N)	$\frac{9\ 550\ 000H}{n_1 \left(\frac{d_{p1}}{2} \right)}$(N)
	$\frac{974\ 000H\eta}{n_1 \left(\frac{d_{p2}}{2} \right)} = \frac{P_1 \eta}{\tan \gamma} = \frac{P_1}{\tan(\gamma + \psi)}$(kgf)	$\frac{974\ 000H}{n_1 \left(\frac{d_{p1}}{2} \right)}$(kgf)
Separating S	$\frac{P_1 \tan \alpha_n}{\sin(\gamma + \psi)} = \frac{P_1 \tan \alpha_s}{\tan(\gamma + \psi)}$(N), (kgf)	$\frac{P_1 \tan \alpha_n}{\sin(\gamma + \psi)} = \frac{P_1 \tan \alpha_s}{\tan(\gamma + \psi)}$(N), (kgf)

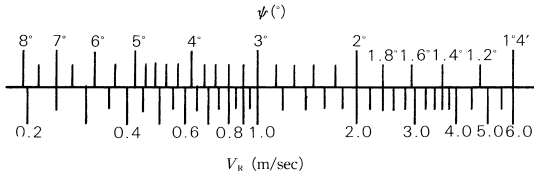

Fig. 4.57

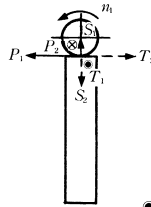
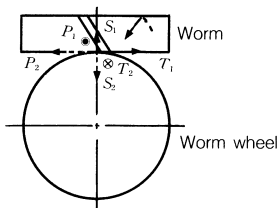

Fig. 4.58 Right twist worm gear

● Vertical upward on paper
⊗ Vertical downward on paper

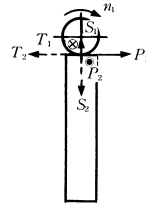
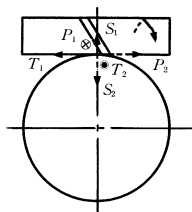

Fig. 4.59 Right twist worm gear (worm rotation is opposite of fig. 4.58)

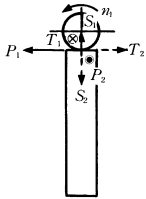
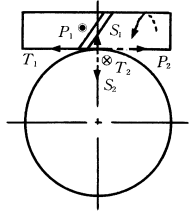

Fig. 4.60 Left twist worm gear

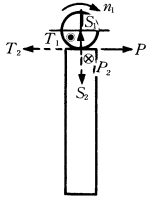
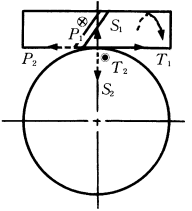
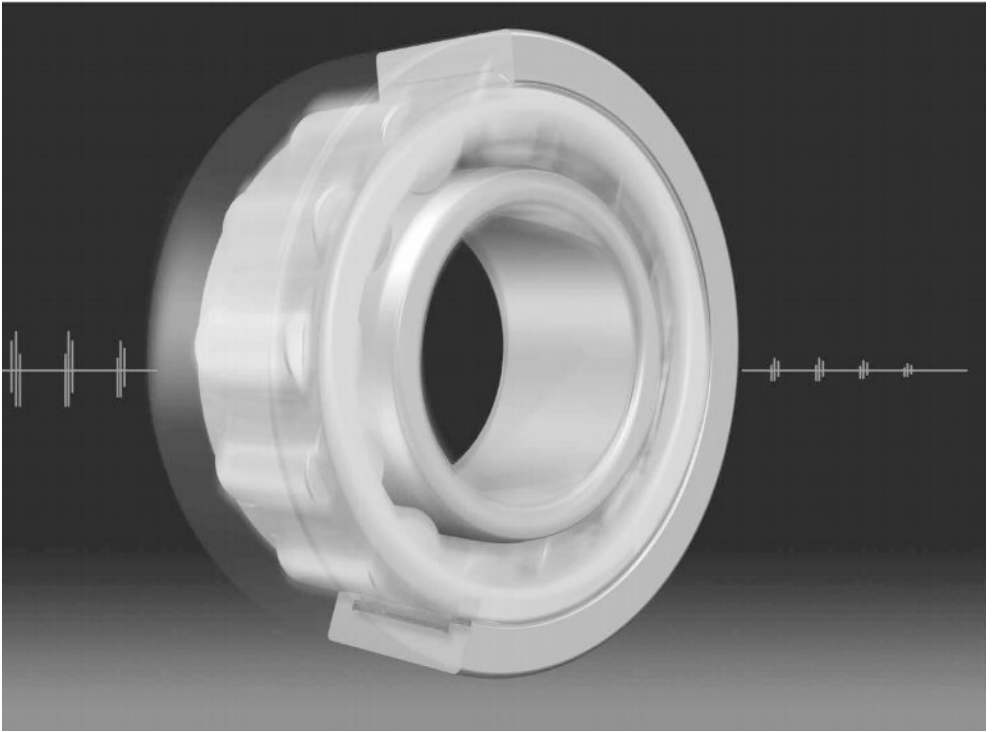

Fig. 4.61 Left twist worm gear (worm rotation is opposite of fig. 4.60)



5. SPEEDS

5.1 Limiting Speed (Grease/Oil)	A 098
5.1.1 Correction of Limiting Speed (Grease/Oil)	A 098
5.1.2 Limiting Speed (Grease/Oil) for Rubber Contact Seals for Ball Bearings	A 099
5.2 Thermal Reference Speed	A 099
5.3 Limiting Speed (Mechanical)	A 099
5.4 Technical Data	A 100
5.4.1 Rotation and Revolution Speed of Rolling Element	A 100

5. Speeds

In this catalog, NSK uses four definitions of speed shown in Table 5.1.

Table 5.1 Overview of Speeds

Speeds	Overview	Applicable lubrication methods
Limiting Speed (Grease)	Empirically obtained and comprehensive bearing limiting speed in grease lubrication.	Grease lubrication
Limiting Speed (Oil)	Empirically obtained and comprehensive bearing limiting speed in oil bath lubrication.	Oil bath lubrication
Thermal Reference Speed (°)	Rotational speed at which equilibrium is reached between the heat generated by the bearing and the heat flow emitted through the shaft and housing under the reference conditions defined by ISO 15312. One among various criteria showing the suitability for operation at high speed.	Oil bath lubrication when subject to reference conditions outlined in ISO 15312
Limiting Speed (Mechanical) (°)	Mechanical and kinematic limiting speed achievable under ideal conditions for lubrication, heat dissipation and temperature.	e.g. Properly designed and controlled forced circulation oil lubrication

Note (°) Thermal reference speeds and limiting speed (mechanical) are listed only in the tables of single row cylindrical roller bearings and spherical roller bearings.

5.1 Limiting Speed (Grease/Oil)

When bearings are operating, the higher the speed, the higher the bearing temperature due to friction. The limiting speed is the empirically obtained value for the maximum speed at which bearings can be continuously operated without generating excessive heat or failing due to seizure. Consequently, the limiting speed of bearings varies depending on such factors as bearing type and size, cage form and material, load, lubricating method, and heat dissipating method including the design of the bearing's surroundings.

The limiting speed (grease) and limiting speed (oil) in the bearing tables are applicable to bearings of standard design and subjected to normal loads, i.e. $C/P \geq 12$ and $F_a/F_r \leq 0.2$ approximately. The limiting speed (oil) listed in the bearing tables is for conventional oil bath lubrication. Some types of lubricants are not suitable for high speed, even though they may be markedly superior in other respects. When speeds are more than 70 percent of the listed limiting speed (grease) or limiting speed (oil), it is necessary to select a grease or oil which has good high speed characteristics. (Refer to)

Table 11.2 Grease Properties (Pages A236 and A237)

Table 11.5 Example of Selection of Lubricant for Bearing Operating Conditions (Page A239)

Table 11.6 Brands and Properties of Lubricating Grease (Pages A240 and A241)

5.1.1 Correction of Limiting Speed (Grease/Oil)

When the bearing load P exceeds 8 % of the basic load rating C , or when the axial load F_a exceeds 20 % of the radial load F_r , the limiting speed (grease) and limiting speed (oil) must be corrected by multiplying the limiting speed value found in

the bearing tables by the correction factor shown in Figs. 5.1 and 5.2. When the required speed exceeds the limiting speed (oil) of the desired bearing, then the accuracy grade, internal clearance, cage type and material, lubrication, etc. must be carefully studied in order to select a bearing capable of the required speed. In such a case, forced-circulation oil lubrication, jet lubrication, oil mist lubrication, or oil-air lubrication must be used. If all these conditions are considered, a corrected maximum permissible speed may be obtained by multiplying the limiting speed (oil) found in the bearing tables by the correction factor shown in table 5.2. It is recommended that NSK be consulted regarding high speed applications.

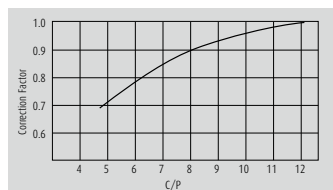

Fig. 5.1 Limiting Speed Correction Factor Variation with Load Ratio

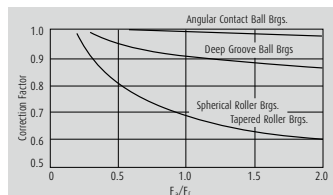

Fig. 5.2 Limiting Speed Correction Factor for Combined Radial and Axial Loads

Table 5.2 Limiting Speed Correction Factor for High-Speed Applications

Bearing Types	Correction Factor
Needle Roller Brgs. (except broad width)	2
Tapered Roller Brgs.	2
Deep Groove Ball Brgs.	2.5
Angular Contact Ball Brgs. (except matched bearings)	1.5

5.1.2 Limiting Speed (Grease/Oil) for Rubber Contact Seals for Ball Bearings

The maximum permissible speed for contact rubber sealed bearings (DDU type) is determined mainly by the sliding surface speed of the inner circumference of the seal. Values for the limiting speed are listed in the bearing tables.

5.2 Thermal Reference Speed

The thermal reference speed is the rotational speed at which equilibrium is reached between the heat generated by the bearing and the heat flow emitted through the shaft and housing under the reference conditions defined by ISO 15312. It is one among various criteria showing the suitability for operation at high speed. The below reference conditions are defined by ISO 15312.

- Outer-ring fixed, Inner-ring rotating
- Mean ambient temperature 20 degrees C
- Mean bearing temperature at the outer ring 70 degrees C
- Load on radial bearings 0.05 Cor
- Oil bath lubrication
- Lubricant ISO VG32 (radial bearings)
- Normal bearing internal clearance

The heat dissipation through the housing and shaft can be obtained from Fig.5.3. In Fig.5.3, A_r (mm^2) is the heat emitting reference surface area. ISO defines A_r as the total area of the bearing's inner ring bore surface and outer ring outside surface (radial bearings), and q_r (W/mm^2) as the heat flow density. The heat dissipation is calculated by multiplying the bearing seating surface area (A_r) by the heat flow density (q_r).

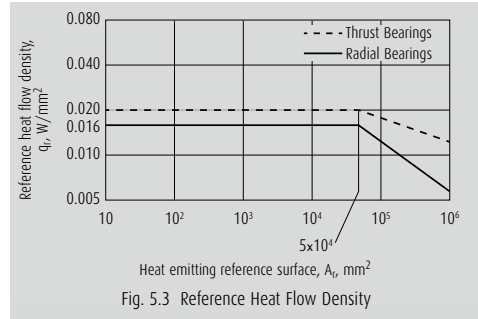

5.3 Limiting Speed (Mechanical)

Limiting speed (mechanical) is the mechanical and kinematic limiting speed of bearings achievable under ideal conditions for lubrication, heat dissipation and temperature, such as with properly designed and controlled forced circulation oil lubrication for high speed conditions.

The limiting speed (mechanical) considers the sliding speed and contact forces between the various bearing elements, the centrifugal and gyratory forces, etc. The values in the tables are applicable to bearings of standard design and subjected to normal loads ($C/P = 12$ approximately).

In the bearing tables of single row cylindrical roller bearings and spherical roller bearings, the thermal reference speeds, limiting speeds (mechanical) and limiting speeds (grease) are listed. In the bearing tables of the other bearing types, the limiting speeds (grease) and limiting speeds (oil) are listed.

Speeds

5.4 Technical Data

5.4.1 Rotation and Revolution Speed of Rolling Element

When the rolling element rotates without slip between bearing rings, the distance which the rolling element rolls on the inner ring raceway is equal to that on the outer ring raceway. This fact allows establishment of a relationship among rolling speed η_i and η_e of the inner and outer rings and the number of rotation η_a of rolling elements.

The revolution speed of the rolling element can be determined as the arithmetic mean of the circumferential speed on the inner ring raceway and that on the outer ring raceway (generally with either the inner or outer ring being stationary). The rotation and revolution of the rolling element can be related as expressed by Equations (5.1) through (5.4).

No. of rotation

$$\eta_a = \left(\frac{D_{pw}}{D_w} - \frac{D_w \cos^2 \alpha}{D_{pw}} \right) \frac{\eta_e - \eta_i}{2} \quad (\text{min}^{-1}) \dots\dots\dots (5.1)$$

Rotational circumferential speed

$$v_a = \frac{\pi D_w}{60 \times 10^3} \left(\frac{D_{pw}}{D_w} - \frac{D_w \cos^2 \alpha}{D_{pw}} \right) \frac{\eta_e - \eta_i}{2} \quad (\text{m/s}) \dots\dots\dots (5.2)$$

No. of revolutions (No. of cage rotation)

$$\eta_c = \left(1 - \frac{D_w \cos \alpha}{D_{pw}} \right) \frac{\eta_i}{2} + \left(1 + \frac{D_w \cos \alpha}{D_{pw}} \right) \frac{\eta_e}{2} \quad (\text{min}^{-1}) \dots\dots\dots (5.3)$$

Revolution circumferential speed
(cage speed at rolling element pitch diameter)

$$v_c = \frac{\pi D_{pw}}{60 \times 10^3} \left[\left(1 - \frac{D_w \cos \alpha}{D_{pw}} \right) \frac{\eta_i}{2} + \left(1 + \frac{D_w \cos \alpha}{D_{pw}} \right) \frac{\eta_e}{2} \right] \quad (\text{m/s}) \dots\dots\dots (5.4)$$

- where, D_{pw} : Pitch diameter of rolling elements (mm)
- D_w : Diameter of rolling element (mm)
- α : Contact angle ($^\circ$)
- η_e : Outer ring speed (min⁻¹)
- η_i : Inner ring speed (min⁻¹)

The rotation and revolution of the rolling element is shown in Table 5.3 for inner ring rotating ($\eta_e = 0$) and outer ring rotating ($\eta_i = 0$) respectively at $0^\circ < \alpha < 90^\circ$ and at $\alpha = 90^\circ$. As an example, Table 5.4 shows the rotation speed η_a and revolution speed η_c of the rolling element during rotating of the inner ring of ball bearings 6210 and 6310.

Contact angle	Rotation/revolution speed
$0^\circ < \alpha < 90^\circ$	η_a (min ⁻¹)
	v_a (m/s)
	η_c (min ⁻¹)
	v_c (m/s)
$\alpha = 90^\circ$	η_a (min ⁻¹)
	v_a (m/s)
	η_c (min ⁻¹)
	v_c (m/s)

Table 5.4 n_a and n_c for Ball Bearings 6210 and 6310

Ball bearing	γ	η_a	η_c
6210	0.181	$-2.67\eta_i$	$0.41\eta_i$
6310	0.232	$-2.04\eta_i$	$0.38\eta_i$

Remark $\gamma = \frac{D_w \cos \alpha}{D_{pw}}$

Table 5.3 Rolling Element's Rotation Speed η_a , Rotational Circumferential Speed v_a , Revolution Speed η_c , and Revolutional Circumferential Speed v_c

Inner ring rolling ($n_e=0$)	Outer ring rolling ($n_i=0$)
$-\left(\frac{1}{\gamma} - \gamma\right) \frac{\eta_i}{2} \cdot \cos \alpha$	$\left(\frac{1}{\gamma} - \gamma\right) \frac{\eta_e}{2} \cdot \cos \alpha$
$\frac{\pi D_w}{60 \times 10^3} \eta_a$	
$(1 - \gamma) \frac{\eta_i}{2}$	$(1 + \gamma) \frac{\eta_e}{2}$
$\frac{\pi D_{pw}}{60 \times 10^3} \eta_c$	
$-\frac{1}{\gamma} \cdot \frac{\eta_i}{2}$	$\frac{1}{\gamma} \cdot \frac{\eta_e}{2}$
$\frac{\pi D_w}{60 \times 10^3} \eta_a$	
$\frac{\eta_i}{2}$	$\frac{\eta_e}{2}$
$\frac{\pi D_{pw}}{60 \times 10^3} \eta_c$	

Reference 1. \pm : The "+" symbol indicates clockwise rotation while the "-" symbol indicates counterclockwise rotation.

2. $\gamma = \frac{D_w \cos \alpha}{D_{pw}}$ ($0^\circ < \alpha < 90^\circ$), $\gamma = \frac{D_w}{D_{pw}}$ ($\alpha = 90^\circ$)



6. BOUNDARY DIMENSIONS AND IDENTIFYING NUMBERS FOR BEARINGS

6.1 Boundary Dimensions and Dimensions of Snap Ring Grooves	A 104
6.1.1 Boundary Dimensions	A 104
6.1.2 Dimensions of Snap Ring Grooves and Locating Snap Rings	A 104
6.2 Formulation of Bearing Numbers	A 120

6. Boundary Dimensions and Identifying Numbers for Bearings

6.1 Boundary Dimensions and Dimensions of Snap Ring Grooves

6.1.1 Boundary Dimensions

The boundary dimensions of rolling bearings, which are shown in Figs. 6.1 through 6.5, are the dimensions that define their external geometry. They include bore diameter d , outside diameter D , width B , bearing width (or height) T , chamfer dimension r , etc. It is necessary to know all of these dimensions when mounting a bearing on a shaft and in a housing. These boundary dimensions have been internationally standardized (ISO15) and adopted by JIS B 1512 (Boundary Dimensions of Rolling Bearings).

The boundary dimensions and dimension series of radial bearings, tapered roller bearings, and thrust bearings are listed in Table 6.1 to 6.3 (Pages A106 to A115).

In these boundary dimension tables, for each bore number, which prescribes the bore diameter, other boundary dimensions are listed for each diameter series and dimension series. A very large number of series are possible; however, not all of them are commercially available so more can be added in the future. Across the top of each bearing table (6.1 to 6.3), representative bearing types and series symbols are shown (refer to Table 6.5, Bearing Series Symbols, Page A121).

The relative cross-sectional dimensions of radial bearings (except tapered roller bearings) and thrust bearings for the various series classifications are shown in Figs. 6.6 and 6.7 respectively.

6.1.2 Dimensions of Snap Ring Grooves and Locating Snap Rings

The dimensions of Snap ring grooves in the outer surfaces of bearings are specified by ISO 464. Also, the dimensions and accuracy of the locating snap rings themselves are specified by ISO 464. The dimensions of snap ring grooves and locating snap ring for bearings of diameter series 8, 9, 0, 2, 3, and 4, are shown in Table 6.4 (Pages A116 to A119).

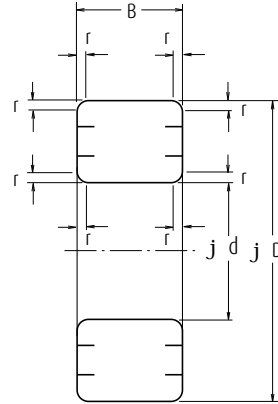

Fig. 6.1 Boundary Dimensions of Radial Ball and Roller Bearings

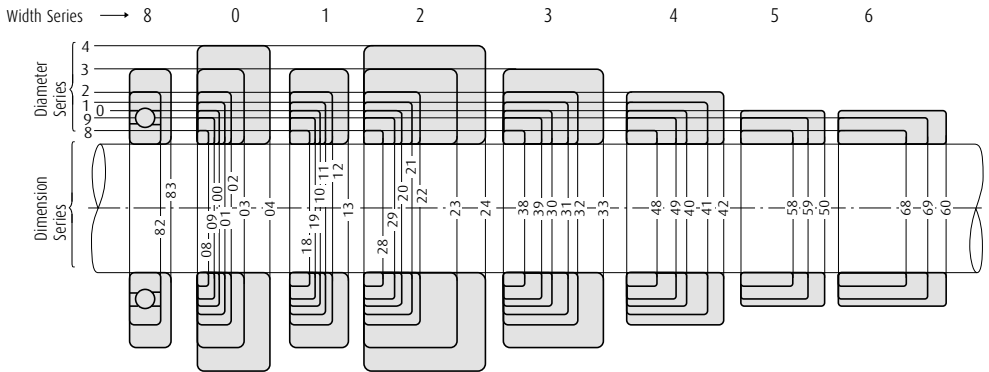

Fig. 6.6 Comparison of Cross Sections of Radial Bearings (except Tapered Roller Bearings) for various Dimensional Series

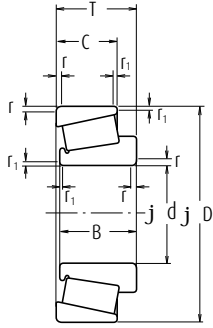

Fig. 6.2 Tapered Roller Bearings

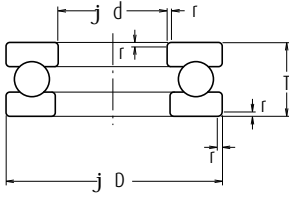

Fig. 6.3 Single-Direction Thrust Ball Bearings

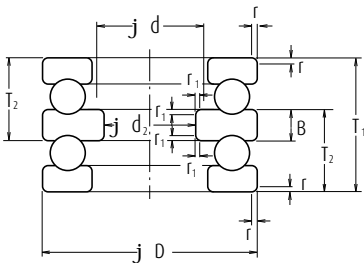

Fig. 6.4 Double-Direction Thrust Ball Bearings

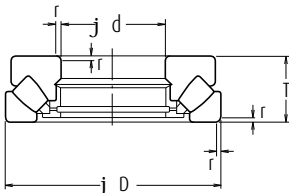

Fig. 6.5 Spherical Thrust Roller Bearings

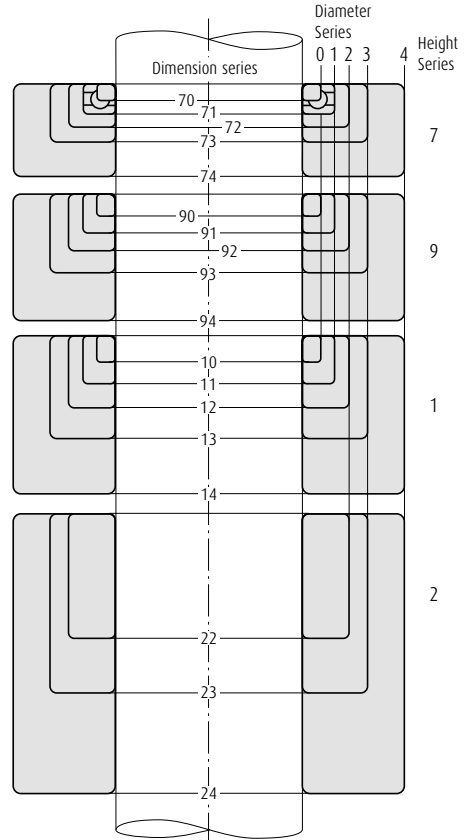

Fig. 6.7 Comparison of Cross Sections of Thrust Bearings (except Diameter Series 5) for Various Dimension Series

Boundary Dimensions and Identifying Numbers for Bearings

Table 6.1 Boundary Dimensions of Radial Bearings (except Tapered Roller Bearings) — 2 —

Bore Number	Units: mm																													
	Diameter Series 1						Diameter Series 2						Diameter Series 3						Diameter Series 4											
	Dimension Series						Dimension Series						Dimension Series						Dimension Series											
	D	01	11	21	31	41	D	82	02	12	22	32	42	D	83	03	13	23	33	D	04	24	04-24							
-	0.6	-	-	-	-	-	-	-	-	-	-	-	-	-	-	-	-	-	-	-	-	-	-	-	-	-				
1	1	-	-	-	-	-	-	-	-	-	-	-	-	-	-	-	-	-	-	-	-	-	-	-	-	-				
-	1.5	-	-	-	-	-	-	-	-	-	-	-	-	-	-	-	-	-	-	-	-	-	-	-	-	-				
2	2	-	-	-	-	-	-	-	-	-	-	-	-	-	-	-	-	-	-	-	-	-	-	-	-	-				
-	2.5	-	-	-	-	-	-	-	-	-	-	-	-	-	-	-	-	-	-	-	-	-	-	-	-	-				
3	3	-	-	-	-	-	10	2.5	4	-	-	5	-	0.1	0.15	13	-	5	-	7	-	0.2	-	-	-					
4	4	-	-	-	-	-	13	3	5	-	7	-	7	-	0.15	0.2	16	-	5	-	9	-	0.3	-	-					
5	5	-	-	-	-	-	16	3.5	5	-	8	-	8	-	0.15	0.3	19	-	6	-	10	-	0.3	-	-					
6	6	-	-	-	-	-	19	4	6	-	10	-	10	-	0.2	0.3	22	-	7	-	11	-	0.3	-	-					
7	7	-	-	-	-	-	22	5	7	-	11	-	11	-	0.3	0.3	26	-	9	-	13	-	0.3	-	-					
8	8	-	-	-	-	-	24	5	8	-	12	-	12	-	0.3	0.3	28	-	9	-	13	-	0.3	-	30	10	14	0.6		
9	9	-	-	-	-	-	26	6	8	-	13	-	13	-	0.3	0.3	30	-	10	-	14	-	0.6	-	32	11	15	0.6		
00	10	-	-	-	-	-	30	7	9	-	14	14.3	-	0.3	0.6	35	9	11	-	17	-	19	-	0.3	0.6	37	12	16	0.6	
01	12	-	-	-	-	-	32	7	10	-	14	15.9	-	0.3	0.6	37	9	12	-	17	-	19	-	0.3	1	42	13	19	1	
02	15	-	-	-	-	-	35	8	11	-	14	15.9	20	0.3	0.6	42	9	13	-	17	-	19	-	0.3	1	52	15	24	1.1	
03	17	-	-	-	-	-	40	8	12	-	16	17.5	22	0.3	0.6	47	10	14	-	19	-	22.2	-	0.6	1	62	17	29	1.1	
04	20	-	-	-	-	-	47	9	14	-	18	20.6	27	0.3	1	52	10	15	-	21	-	22.2	-	0.6	1.1	72	19	33	1.1	
22	22	-	-	-	-	-	50	9	14	-	18	20.6	27	0.3	1	62	12	17	-	24	-	25.4	-	0.6	1.1	80	21	36	1.5	
05	25	-	-	-	-	-	52	10	15	-	18	20.6	27	0.3	1	62	13	18	-	24	-	25.4	-	0.6	1.1	80	21	36	1.5	
28	28	-	-	-	-	-	58	10	16	-	19	23	30	0.6	1	68	13	18	-	24	-	30	-	0.6	1.1	-	-	-	-	
06	30	-	-	-	-	-	62	10	16	-	20	23.8	32	0.6	1	72	13	19	-	27	-	30.2	-	0.6	1.1	90	23	40	1.5	
32	32	-	-	-	-	-	65	11	17	-	21	25	33	0.6	1	75	14	20	-	28	-	32	-	0.6	1.1	-	-	-	-	
07	35	-	-	-	-	-	72	12	17	-	23	27	37	0.6	1.1	80	14	21	-	31	-	34.9	-	0.6	1.5	100	25	43	1.5	
08	40	-	-	-	-	-	80	13	18	-	23	30.2	40	0.6	1.1	90	16	23	-	33	-	36.5	-	1	1.5	120	27	46	2	
09	45	-	-	-	-	-	85	13	19	-	23	30.2	40	0.6	1.1	100	17	25	-	36	-	39.7	-	1	1.5	120	29	50	2	
10	50	-	-	-	-	-	90	13	20	-	23	30.2	40	0.6	1.1	110	19	27	-	40	-	44.4	-	1	2	130	31	53	2.1	
11	55	-	-	-	-	-	100	14	21	-	25	33.3	45	0.6	1.5	120	21	29	-	43	-	49.2	-	1.1	2	140	33	57	2.1	
12	60	-	-	-	-	-	110	16	22	-	28	36.5	50	1	1.5	130	22	31	-	46	-	54	-	1.1	2.1	150	35	60	2.1	
13	65	-	-	-	-	-	120	18	23	-	31	38.1	56	1	1.5	140	24	33	-	48	-	58.7	-	1.1	2.1	160	37	64	2.1	
14	70	-	-	-	-	-	125	18	24	-	31	39.7	56	1	1.5	150	25	35	-	51	-	63.5	-	1.5	2.1	180	42	74	3	
15	75	-	-	-	-	-	130	18	25	-	31	41.3	56	1	1.5	160	27	37	-	55	-	68.3	-	1.5	2.1	190	45	77	3	
16	80	-	-	-	-	-	140	19	26	-	33	44.4	60	1	2	170	28	39	-	58	-	68.3	-	1.5	2.1	200	48	80	3	
17	85	-	-	-	-	-	150	21	28	-	36	49.2	65	1.1	2	180	30	41	-	60	-	73	-	2	3	210	52	86	4	
18	90	-	-	-	-	-	160	22	30	-	40	52.4	69	1.1	2.1	190	30	43	-	64	-	73	-	2	3	225	54	90	4	
19	95	-	-	-	-	-	170	24	32	-	43	55.6	75	1.1	2.1	200	33	45	-	67	-	77.8	-	2	3	240	55	95	4	
20	100	165	21	30	39	52	65	1.1	2	180	25	34	-	46	60.3	80	1.5	2.1	215	36	47	51	73	82.6	2.1	3	250	58	98	4

Units: mm

302		322				332					303 or 303D				313			323					Tapered Roller Brigs.																												
D	Diameter Series 2										Diameter Series 3															d	Bore Number																								
	Dimension Series 02			Dimension Series 22			Dimension Series 32			Chamfer Dimension		D	Dimension Series 03				Dimension Series 13			Dimension Series 23			Chamfer Dimension																												
	B	C	T	B	C	T	B	C	T	r	Cup		B	C	C ⁽¹⁾	T	B	C	T	B	C	T	r	Cone	Cup																										
																												r (min.)																							
30	9	-	9.7	14	-	14.7	-	-	-	0.6	0.6	35	11	-	-	11.9	-	-	-	17	-	17.9	0.6	0.6	10	00																									
32	10	9	10.75	14	-	14.75	-	-	-	0.6	0.6	37	12	-	-	12.9	-	-	-	17	-	17.9	1	1	12	01																									
35	11	10	11.75	14	-	14.75	-	-	-	0.6	0.6	42	13	11	-	14.25	-	-	-	17	14	18.25	1	1	15	02																									
40	12	11	13.25	16	14	17.25	-	-	-	1	1	47	14	12	-	15.25	-	-	-	19	16	20.25	1	1	17	03																									
47	14	12	15.25	18	15	19.25	-	-	-	1	1	52	15	13	-	16.25	-	-	-	21	18	22.25	1.5	1.5	20	04																									
50	14	12	15.25	18	15	19.25	-	-	-	1	1	56	16	14	-	17.25	-	-	-	21	18	22.25	1.5	1.5	22	/22																									
52	15	13	16.25	18	15	19.25	22	18	22	1	1	62	17	15	13	18.25	-	-	-	24	20	25.25	1.5	1.5	25	05																									
58	16	14	17.25	19	16	20.25	24	19	24	1	1	68	18	15	14	19.75	-	-	-	24	20	25.75	1.5	1.5	28	/28																									
62	16	14	17.25	20	17	21.25	25	19.5	25	1	1	72	19	16	14	20.75	-	-	-	27	23	28.75	1.5	1.5	30	06																									
65	17	15	18.25	21	18	22.25	26	20.5	26	1	1	75	20	17	15	21.75	-	-	-	28	24	29.75	1.5	1.5	32	/32																									
72	17	15	18.25	23	19	24.25	28	22	28	1.5	1.5	80	21	18	15	22.75	-	-	-	31	25	32.75	2	1.5	35	07																									
80	18	16	19.75	23	19	24.75	32	25	32	1.5	1.5	90	23	20	17	25.25	-	-	-	33	27	35.25	2	1.5	40	08																									
85	19	16	20.75	23	19	24.75	32	25	32	1.5	1.5	100	25	22	18	27.25	-	-	-	36	30	38.25	2	1.5	45	09																									
90	20	17	21.75	23	19	24.75	32	24.5	32	1.5	1.5	110	27	23	19	29.25	-	-	-	40	33	42.25	2.5	2	50	10																									
100	21	18	22.75	25	21	26.75	35	27	35	2	1.5	120	29	25	21	31.5	-	-	-	43	35	45.5	2.5	2	55	11																									
110	22	19	23.75	28	24	29.75	38	29	38	2	1.5	130	31	26	22	33.5	-	-	-	46	37	48.5	3	2.5	60	12																									
120	23	20	24.75	31	27	32.75	41	32	41	2	1.5	140	33	28	23	36	-	-	-	48	39	51	3	2.5	65	13																									
125	24	21	26.25	31	27	33.25	41	32	41	2	1.5	150	35	30	25	38	-	-	-	51	42	54	3	2.5	70	14																									
130	25	22	27.25	31	27	33.25	41	31	41	2	1.5	160	37	31	26	40	-	-	-	55	45	58	3	2.5	75	15																									
140	26	22	28.25	33	28	35.25	46	35	46	2.5	2	170	39	33	27	42.5	-	-	-	58	48	61.5	3	2.5	80	16																									
150	28	24	30.5	36	30	38.5	49	37	49	2.5	2	180	41	34	28	44.5	-	-	-	60	49	63.5	4	3	85	17																									
160	30	26	32.5	40	34	42.5	55	42	55	2.5	2	190	43	36	30	46.5	-	-	-	64	53	67.5	4	3	90	18																									
170	32	27	34.5	43	37	45.5	58	44	58	3	2.5	200	45	38	32	49.5	-	-	-	67	55	71.5	4	3	95	19																									
180	34	29	37	46	39	49	63	48	63	3	2.5	215	47	39	-	51.5	51	35	56.5	73	60	77.5	4	3	100	20																									
190	36	30	39	50	43	53	68	52	68	3	2.5	225	49	41	-	53.5	53	36	58	77	63	81.5	4	3	105	21																									
200	38	32	41	53	46	56	-	-	-	3	2.5	240	50	42	-	54.5	57	38	63	80	65	84.5	4	3	110	22																									
215	40	34	43.5	58	50	61.5	-	-	-	3	2.5	260	55	46	-	59.5	62	42	68	86	69	90.5	4	3	120	24																									
230	40	34	43.75	64	54	67.75	-	-	-	4	3	280	58	49	-	63.75	66	44	72	93	78	98.75	5	4	130	26																									
250	42	36	45.75	68	58	71.75	-	-	-	4	3	300	62	53	-	67.75	70	47	77	102	85	107.75	5	4	140	28																									
270	45	38	49	73	60	77	-	-	-	4	3	320	65	55	-	72	75	50	82	108	90	114	5	4	150	30																									
290	48	40	52	80	67	84	-	-	-	4	3	340	68	58	-	75	79	-	87	114	95	121	5	4	160	32																									
310	52	43	57	86	71	91	-	-	-	5	4	360	72	62	-	80	84	-	92	120	100	127	5	4	170	34																									
320	52	43	57	86	71	91	-	-	-	5	4	380	75	64	-	83	88	-	97	126	106	134	5	4	180	36																									
340	55	46	60	92	75	97	-	-	-	5	4	400	78	65	-	86	92	-	101	132	109	140	6	5	190	38																									
360	58	48	64	98	82	104	-	-	-	5	4	420	80	67	-	89	97	-	107	138	115	146	6	5	200	40																									
400	65	54	72	108	90	114	-	-	-	5	4	460	88	73	-	97	106	-	117	145	122	154	6	5	220	44																									
440	72	60	79	120	100	127	-	-	-	5	4	500	95	80	-	105	114	-	125	155	132	165	6	5	240	48																									
480	80	67	89	130	106	137	-	-	-	6	5	540	102	85	-	113	123	-	135	165	136	176	6	6	260	52																									
500	80	67	89	130	106	137	-	-	-	6	5	580	108	90	-	119	132	-	145	175	145	187	6	6	280	56																									
540	85	71	96	140	115	149	-	-	-	6	5	-	-	-	-	-	-	-	-	-	-	-	-	-	300	60																									
580	92	75	104	150	125	159	-	-	-	6	5	-	-	-	-	-	-	-	-	-	-	-	-	-	320	64																									
-	-	-	-	-	-	-	-	-	-	-	-	-	-	-	-	-	-	-	-	-	-	-	-	-	340	68																									
-	-	-	-	-	-	-	-	-	-	-	-	-	-	-	-	-	-	-	-	-	-	-	-	-	360	72																									

Note (1) Regarding steep-slope bearing 303D, in DIN, the one corresponding to 303D of JIS is numbered 313. For bearings with bore diameters larger than 100 mm, those of dimension series 13 are numbered 313.

Boundary Dimensions and Identifying Numbers for Bearings

Table 6.3 Boundary Dimensions of Thrust Bearings (Flat Seats) — 1 —

Thrust Ball Brgs.							511					512					522				
Spherical Thrust Roller Brgs.												292									
Bore Number	d	Diameter Series 0					Diameter Series 1					Diameter Series 2									
		D	Dimension Series			r(min.)	D	Dimension Series			r(min.)	D	Dimension Series					r(min.)	r ₁ (min.)		
			70	90	10			71	91	11			72	92	12	22	22				
		T			T			T					Central Washer								
											d ₂	B									
4	4	12	4	-	6	0.3	-	-	-	-	-	16	6	-	8	-	-	-	0.3	-	
6	6	16	5	-	7	0.3	-	-	-	-	-	20	6	-	9	-	-	-	0.3	-	
8	8	18	5	-	7	0.3	-	-	-	-	-	22	6	-	9	-	-	-	0.3	-	
00	10	20	5	-	7	0.3	24	6	-	9	0.3	26	7	-	11	-	-	-	0.6	-	
01	12	22	5	-	7	0.3	26	6	-	9	0.3	28	7	-	11	-	-	-	0.6	-	
02	15	26	5	-	7	0.3	28	6	-	9	0.3	32	8	-	12	22	10	5	0.6	0.3	
03	17	28	5	-	7	0.3	30	6	-	9	0.3	35	8	-	12	-	-	-	0.6	-	
04	20	32	6	-	8	0.3	35	7	-	10	0.3	40	9	-	14	26	15	6	0.6	0.3	
05	25	37	6	-	8	0.3	42	8	-	11	0.6	47	10	-	15	28	20	7	0.6	0.3	
06	30	42	6	-	8	0.3	47	8	-	11	0.6	52	10	-	16	29	25	7	0.6	0.3	
07	35	47	6	-	8	0.3	52	8	-	12	0.6	62	12	-	18	34	30	8	1	0.3	
08	40	52	6	-	9	0.3	60	9	-	13	0.6	68	13	-	19	36	30	9	1	0.6	
09	45	60	7	-	10	0.3	65	9	-	14	0.6	73	13	-	20	37	35	9	1	0.6	
10	50	65	7	-	10	0.3	70	9	-	14	0.6	78	13	-	22	39	40	9	1	0.6	
11	55	70	7	-	10	0.3	78	10	-	16	0.6	90	16	21	25	45	45	10	1	0.6	
12	60	75	7	-	10	0.3	85	11	-	17	1	95	16	21	26	46	50	10	1	0.6	
13	65	80	7	-	10	0.3	90	11	-	18	1	100	16	21	27	47	55	10	1	0.6	
14	70	85	7	-	10	0.3	95	11	-	18	1	105	16	21	27	47	55	10	1	1	
15	75	90	7	-	10	0.3	100	11	-	19	1	110	16	21	27	47	60	10	1	1	
16	80	95	7	-	10	0.3	105	11	-	19	1	115	16	21	28	48	65	10	1	1	
17	85	100	7	-	10	0.3	110	11	-	19	1	125	18	24	31	55	70	12	1	1	
18	90	105	7	-	10	0.3	120	14	-	22	1	135	20	27	35	62	75	14	1.1	1	
20	100	120	9	-	14	0.6	135	16	21	25	1	150	23	30	38	67	85	15	1.1	1	
22	110	130	9	-	14	0.6	145	16	21	25	1	160	23	30	38	67	95	15	1.1	1	
24	120	140	9	-	14	0.6	155	16	21	25	1	170	23	30	39	68	100	15	1.1	1.1	
26	130	150	9	-	14	0.6	170	18	24	30	1	190	27	36	45	80	110	18	1.5	1.1	
28	140	160	9	-	14	0.6	180	18	24	31	1	200	27	36	46	81	120	18	1.5	1.1	
30	150	170	9	-	14	0.6	190	18	24	31	1	215	29	39	50	89	130	20	1.5	1.1	
32	160	180	9	-	14	0.6	200	18	24	31	1	225	29	39	51	90	140	20	1.5	1.1	
34	170	190	9	-	14	0.6	215	20	27	34	1.1	240	32	42	55	97	150	21	1.5	1.1	
36	180	200	9	-	14	0.6	225	20	27	34	1.1	250	32	42	56	98	150	21	1.5	2	
38	190	215	11	-	17	1	240	23	30	37	1.1	270	36	48	62	109	160	24	2	2	
40	200	225	11	-	17	1	250	23	30	37	1.1	280	36	48	62	109	170	24	2	2	
44	220	250	14	-	22	1	270	23	30	37	1.1	300	36	48	63	110	190	24	2	2	
48	240	270	14	-	22	1	300	27	36	45	1.5	340	45	60	78	-	-	-	2.1	-	
52	260	290	14	-	22	1	320	27	36	45	1.5	360	45	60	79	-	-	-	2.1	-	
56	280	310	14	-	22	1	350	32	42	53	1.5	380	45	60	80	-	-	-	2.1	-	
60	300	340	18	24	30	1	380	36	48	62	2	420	54	73	95	-	-	-	3	-	
64	320	360	18	24	30	1	400	36	48	63	2	440	54	73	95	-	-	-	3	-	

- Remarks**
1. Dimension Series 22, 23, and 24 are double direction bearings.
 2. The maximum permissible outside diameter of shaft and central washers and minimum permissible bore diameter of housing washers are omitted here. (Refer to the bearings tables for Thrust Bearings).

Units: mm

		513		523						514		524						Thrust Ball Brgs.				
		293								294								Spherical Thrust Roller Brgs.				
Diameter Series 3									Diameter Series 4									Diameter Series 5			d	Bore Number
D	Dimension Series						r(min.)	r ₁ (min.)	D	Dimension Series						r(min.)	r ₁ (min.)	D	Dimension Series			
	73	93	13	23	23					74	94	14	24	24					95	r(min.)		
	T									T									T			
Central Washer						Central Washer						Central Washer										
												d ₂		B								
20	7	-	11	-	-	-	0.6	-	-	-	-	-	-	-	-	-	-	-	4	4		
24	8	-	12	-	-	-	0.6	-	-	-	-	-	-	-	-	-	-	-	6	6		
26	8	-	12	-	-	-	0.6	-	-	-	-	-	-	-	-	-	-	-	8	8		
30	9	-	14	-	-	-	0.6	-	-	-	-	-	-	-	-	-	-	-	10	00		
32	9	-	14	-	-	-	0.6	-	-	-	-	-	-	-	-	-	-	-	12	01		
37	10	-	15	-	-	-	0.6	-	-	-	-	-	-	-	-	-	-	-	15	02		
40	10	-	16	-	-	-	0.6	-	-	-	-	-	-	-	-	-	52	21	1	17	03	
47	12	-	18	-	-	-	1	-	-	-	-	-	-	-	-	-	60	24	1	20	04	
52	12	-	18	34	20	8	1	0.3	60	16	21	24	45	15	11	1	0.6	73	29	1.1	25	05
60	14	-	21	38	25	9	1	0.3	70	18	24	28	52	20	12	1	0.6	85	34	1.1	30	06
68	15	-	24	44	30	10	1	0.3	80	20	27	32	59	25	14	1.1	0.6	100	39	1.1	35	07
78	17	22	26	49	30	12	1	0.6	90	23	30	36	65	30	15	1.1	0.6	110	42	1.5	40	08
85	18	24	28	52	35	12	1	0.6	100	25	34	39	72	35	17	1.1	0.6	120	45	2	45	09
95	20	27	31	58	40	14	1.1	0.6	110	27	36	43	78	40	18	1.5	0.6	135	51	2	50	10
105	23	30	35	64	45	15	1.1	0.6	120	29	39	48	87	45	20	1.5	0.6	150	58	2.1	55	11
110	23	30	35	64	50	15	1.1	0.6	130	32	42	51	93	50	21	1.5	0.6	160	60	2.1	60	12
115	23	30	36	65	55	15	1.1	0.6	140	34	45	56	101	50	23	2	1	170	63	2.1	65	13
125	25	34	40	72	55	16	1.1	1	150	36	48	60	107	55	24	2	1	180	67	3	70	14
135	27	36	44	79	60	18	1.5	1	160	38	51	65	115	60	26	2	1	190	69	3	75	15
140	27	36	44	79	65	18	1.5	1	170	41	54	68	120	65	27	2.1	1	200	73	3	80	16
150	29	39	49	87	70	19	1.5	1	180	42	58	72	128	65	29	2.1	1.1	215	78	4	85	17
155	29	39	50	88	75	19	1.5	1	190	45	60	77	135	70	30	2.1	1.1	225	82	4	90	18
170	32	42	55	97	85	21	1.5	1	210	50	67	85	150	80	33	3	1.1	250	90	4	100	20
190	36	48	63	110	95	24	2	1	230	54	73	95	166	90	37	3	1.1	270	95	5	110	22
210	41	54	70	123	100	27	2.1	1.1	250	58	78	102	177	95	40	4	1.5	300	109	5	120	24
225	42	58	75	130	110	30	2.1	1.1	270	63	85	110	192	100	42	4	2	320	115	5	130	26
240	45	60	80	140	120	31	2.1	1.1	280	63	85	112	196	110	44	4	2	340	122	5	140	28
250	45	60	80	140	130	31	2.1	1.1	300	67	90	120	209	120	46	4	2	360	125	6	150	30
270	50	67	87	153	140	33	3	1.1	320	73	95	130	226	130	50	5	2	380	132	6	160	32
280	50	67	87	153	150	33	3	1.1	340	78	103	135	236	135	50	5	2.1	400	140	6	170	34
300	54	73	95	165	150	37	3	2	360	82	109	140	245	140	52	5	3	420	145	6	180	36
320	58	78	105	183	160	40	4	2	380	85	115	150	-	-	-	5	-	440	150	6	190	38
340	63	85	110	192	170	42	4	2	400	90	122	155	-	-	-	5	-	460	155	7.5	200	40
360	63	85	112	-	-	-	4	-	420	90	122	160	-	-	-	6	-	500	170	7.5	220	44
380	63	85	112	-	-	-	4	-	440	90	122	160	-	-	-	6	-	540	180	7.5	240	48
420	73	95	130	-	-	-	5	-	480	100	132	175	-	-	-	6	-	580	190	9.5	260	52
440	73	95	130	-	-	-	5	-	520	109	145	190	-	-	-	6	-	620	206	9.5	280	56
480	82	109	140	-	-	-	5	-	540	109	145	190	-	-	-	6	-	670	224	9.5	300	60
500	82	109	140	-	-	-	5	-	580	118	155	205	-	-	-	7.5	-	710	236	9.5	320	64

Boundary Dimensions and Identifying Numbers for Bearings

Table 6.3 Boundary Dimensions of Thrust Bearings (Flat Seats) — 2 —

Thrust Ball Brgs.							511					512					522				
Spherical Thrust Roller Brgs.												292									
Bore Number	d	Diameter Series 0					Diameter Series 1					Diameter Series 2									
		D	Dimension Series			r(min.)	D	Dimension Series			r(min.)	D	Dimension Series					r(min.)	r ₁ (min.)		
			70	90	10			71	91	11			72	92	12	22	22				
		T			T			T					Central Washer								
											d ₂	B									
68	340	380	18	24	30	1	420	36	48	64	2	460	54	73	96	-	-	-	3	-	
72	360	400	18	24	30	1	440	36	48	65	2	500	63	85	110	-	-	-	4	-	
76	380	420	18	24	30	1	460	36	48	65	2	520	63	85	112	-	-	-	4	-	
80	400	440	18	24	30	1	480	36	48	65	2	540	63	85	112	-	-	-	4	-	
84	420	460	18	24	30	1	500	36	48	65	2	580	73	95	130	-	-	-	5	-	
88	440	480	18	24	30	1	540	45	60	80	2.1	600	73	95	130	-	-	-	5	-	
92	460	500	18	24	30	1	560	45	60	80	2.1	620	73	95	130	-	-	-	5	-	
96	480	520	18	24	30	1	580	45	60	80	2.1	650	78	103	135	-	-	-	5	-	
/500	500	540	18	24	30	1	600	45	60	80	2.1	670	78	103	135	-	-	-	5	-	
/530	530	580	23	30	38	1.1	640	50	67	85	3	710	82	109	140	-	-	-	5	-	
/560	560	610	23	30	38	1.1	670	50	67	85	3	750	85	115	150	-	-	-	5	-	
/600	600	650	23	30	38	1.1	710	50	67	85	3	800	90	122	160	-	-	-	5	-	
/630	630	680	23	30	38	1.1	750	54	73	95	3	850	100	132	175	-	-	-	6	-	
/670	670	730	27	36	45	1.5	800	58	78	105	4	900	103	140	180	-	-	-	6	-	
/710	710	780	32	42	53	1.5	850	63	85	112	4	950	109	145	190	-	-	-	6	-	
/750	750	820	32	42	53	1.5	900	67	90	120	4	1000	112	150	195	-	-	-	6	-	
/800	800	870	32	42	53	1.5	950	67	90	120	4	1060	118	155	205	-	-	-	7.5	-	
/850	850	920	32	42	53	1.5	1000	67	90	120	4	1120	122	160	212	-	-	-	7.5	-	
/900	900	980	36	48	63	2	1060	73	95	130	5	1180	125	170	220	-	-	-	7.5	-	
/950	950	1030	36	48	63	2	1120	78	103	135	5	1250	136	180	236	-	-	-	7.5	-	
/1000	1000	1090	41	54	70	2.1	1180	82	109	140	5	1320	145	190	250	-	-	-	9.5	-	
/1060	1060	1150	41	54	70	2.1	1250	85	115	150	5	1400	155	206	265	-	-	-	9.5	-	
/1120	1120	1220	45	60	80	2.1	1320	90	122	160	5	1460	-	206	-	-	-	-	9.5	-	
/1180	1180	1280	45	60	80	2.1	1400	100	132	175	6	1520	-	206	-	-	-	-	9.5	-	
/1250	1250	1360	50	67	85	3	1460	-	-	175	6	1610	-	216	-	-	-	-	9.5	-	
/1320	1320	1440	-	-	95	3	1540	-	-	175	6	1700	-	228	-	-	-	-	9.5	-	
/1400	1400	1520	-	-	95	3	1630	-	-	180	6	1790	-	234	-	-	-	-	12	-	
/1500	1500	1630	-	-	105	4	1750	-	-	195	6	1920	-	252	-	-	-	-	12	-	
/1600	1600	1730	-	-	105	4	1850	-	-	195	6	2040	-	264	-	-	-	-	15	-	
/1700	1700	1840	-	-	112	4	1970	-	-	212	7.5	2160	-	276	-	-	-	-	15	-	
/1800	1800	1950	-	-	120	4	2080	-	-	220	7.5	2280	-	288	-	-	-	-	15	-	
/1900	1900	2060	-	-	130	5	2180	-	-	220	7.5	-	-	-	-	-	-	-	-	-	
/2000	2000	2160	-	-	130	5	2300	-	-	236	7.5	-	-	-	-	-	-	-	-	-	
/2120	2120	2300	-	-	140	5	2430	-	-	243	7.5	-	-	-	-	-	-	-	-	-	
/2240	2240	2430	-	-	150	5	2570	-	-	258	9.5	-	-	-	-	-	-	-	-	-	
/2360	2360	2550	-	-	150	5	2700	-	-	265	9.5	-	-	-	-	-	-	-	-	-	
/2500	2500	2700	-	-	160	5	2850	-	-	272	9.5	-	-	-	-	-	-	-	-	-	

- Remarks**
1. Dimension Series 22, 23, and 24 are double direction bearings.
 2. The maximum permissible outside diameter of shaft and central washers and minimum permissible bore diameter of housing washers are omitted here. (Refer to the bearings tables for Thrust Bearings).

Units: mm

		513		523						514		524						Thrust Ball Brgs.				
		293								294								Spherical Thrust Roller Brgs.				
Diameter Series 3									Diameter Series 4									Diameter Series 5			d	Bore Number
D	Dimension Series						r(min.)	r ₁ (min.)	D	Dimension Series						r(min.)	r ₁ (min.)	D	Dimension Series			
	73	93	13	23	23					74	94	14	24	24					95	r(min.)		
	T					Central Washer				T					Central Washer				T			
					d ₂	B						d ₂	B									
540	90	122	160	-	-	-	5	-	620	125	170	220	-	-	-	7.5	-	750	243	12	340	68
560	90	122	160	-	-	-	5	-	640	125	170	220	-	-	-	7.5	-	780	250	12	360	72
600	100	132	175	-	-	-	6	-	670	132	175	224	-	-	-	7.5	-	820	265	12	380	76
620	100	132	175	-	-	-	6	-	710	140	185	243	-	-	-	7.5	-	850	272	12	400	80
650	103	140	180	-	-	-	6	-	730	140	185	243	-	-	-	7.5	-	900	290	15	420	84
680	109	145	190	-	-	-	6	-	780	155	206	265	-	-	-	9.5	-	950	308	15	440	88
710	112	150	195	-	-	-	6	-	800	155	206	265	-	-	-	9.5	-	980	315	15	460	92
730	112	150	195	-	-	-	6	-	850	165	224	290	-	-	-	9.5	-	1000	315	15	480	96
750	112	150	195	-	-	-	6	-	870	165	224	290	-	-	-	9.5	-	1060	335	15	500	/500
800	122	160	212	-	-	-	7.5	-	920	175	236	308	-	-	-	9.5	-	1090	335	15	530	/530
850	132	175	224	-	-	-	7.5	-	980	190	250	335	-	-	-	12	-	1150	355	15	560	/560
900	136	180	236	-	-	-	7.5	-	1030	195	258	335	-	-	-	12	-	1220	375	15	600	/600
950	145	190	250	-	-	-	9.5	-	1090	206	280	365	-	-	-	12	-	1280	388	15	630	/630
1000	150	200	258	-	-	-	9.5	-	1150	218	290	375	-	-	-	15	-	1320	388	15	670	/670
1060	160	212	272	-	-	-	9.5	-	1220	230	308	400	-	-	-	15	-	1400	412	15	710	/710
1120	165	224	290	-	-	-	9.5	-	1280	236	315	412	-	-	-	15	-	-	-	-	750	/750
1180	170	230	300	-	-	-	9.5	-	1360	250	335	438	-	-	-	15	-	-	-	-	800	/800
1250	180	243	315	-	-	-	12	-	1440	-	354	-	-	-	-	15	-	-	-	-	850	/850
1320	190	250	335	-	-	-	12	-	1520	-	372	-	-	-	-	15	-	-	-	-	900	/900
1400	200	272	355	-	-	-	12	-	1600	-	390	-	-	-	-	15	-	-	-	-	950	/950
1460	-	276	-	-	-	-	12	-	1670	-	402	-	-	-	-	15	-	-	-	-	1000	/1000
1540	-	288	-	-	-	-	15	-	1770	-	426	-	-	-	-	15	-	-	-	-	1060	/1060
1630	-	306	-	-	-	-	15	-	1860	-	444	-	-	-	-	15	-	-	-	-	1120	/1120
1710	-	318	-	-	-	-	15	-	1950	-	462	-	-	-	-	19	-	-	-	-	1180	/1180
1800	-	330	-	-	-	-	19	-	2050	-	480	-	-	-	-	19	-	-	-	-	1250	/1250
1900	-	348	-	-	-	-	19	-	2160	-	505	-	-	-	-	19	-	-	-	-	1320	/1320
2000	-	360	-	-	-	-	19	-	2280	-	530	-	-	-	-	19	-	-	-	-	1400	/1400
2140	-	384	-	-	-	-	19	-	-	-	-	-	-	-	-	-	-	-	-	-	1500	/1500
2270	-	402	-	-	-	-	19	-	-	-	-	-	-	-	-	-	-	-	-	-	1600	/1600
-	-	-	-	-	-	-	-	-	-	-	-	-	-	-	-	-	-	-	-	-	1700	/1700
-	-	-	-	-	-	-	-	-	-	-	-	-	-	-	-	-	-	-	-	-	1800	/1800
-	-	-	-	-	-	-	-	-	-	-	-	-	-	-	-	-	-	-	-	-	1900	/1900
-	-	-	-	-	-	-	-	-	-	-	-	-	-	-	-	-	-	-	-	-	2000	/2000
-	-	-	-	-	-	-	-	-	-	-	-	-	-	-	-	-	-	-	-	-	2120	/2120
-	-	-	-	-	-	-	-	-	-	-	-	-	-	-	-	-	-	-	-	-	2240	/2240
-	-	-	-	-	-	-	-	-	-	-	-	-	-	-	-	-	-	-	-	-	2360	/2360
-	-	-	-	-	-	-	-	-	-	-	-	-	-	-	-	-	-	-	-	-	2500	/2500

Boundary Dimensions and Identifying Numbers for Bearings

**Table 6.4 Dimensions of Snap Ring Grooves and Locating Snap Rings – (1)
Bearings of Dimension Series 18 and 19**

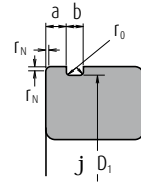

Applicable Bearings		Snap Ring Groove									
d		D	Snap Ring Groove Diameter D ₁		Snap Ring Groove Position a				Snap Ring Groove Width b		Radius of Bottom Corners r ₀
					Bearing Dimension Series						
Dimension Series			max.	min.	18		19		max.	min.	max.
18	19				max.	min.	max.	min.			
-	10	22	20.8	20.5	-	-	1.05	0.9	1.05	0.8	0.2
-	12	24	22.8	22.5	-	-	1.05	0.9	1.05	0.8	0.2
-	15	28	26.7	26.4	-	-	1.3	1.15	1.2	0.95	0.25
-	17	30	28.7	28.4	-	-	1.3	1.15	1.2	0.95	0.25
20	-	32	30.7	30.4	1.3	1.15	-	-	1.2	0.95	0.25
22	-	34	32.7	32.4	1.3	1.15	-	-	1.2	0.95	0.25
25	20	37	35.7	35.4	1.3	1.15	1.7	1.55	1.2	0.95	0.25
-	22	39	37.7	37.4	-	-	1.7	1.55	1.2	0.95	0.25
28	-	40	38.7	38.4	1.3	1.15	-	-	1.2	0.95	0.25
30	25	42	40.7	40.4	1.3	1.15	1.7	1.55	1.2	0.95	0.25
32	-	44	42.7	42.4	1.3	1.15	-	-	1.2	0.95	0.25
-	28	45	43.7	43.4	-	-	1.7	1.55	1.2	0.95	0.25
35	30	47	45.7	45.4	1.3	1.15	1.7	1.55	1.2	0.95	0.25
40	32	52	50.7	50.4	1.3	1.15	1.7	1.55	1.2	0.95	0.25
-	35	55	53.7	53.4	-	-	1.7	1.55	1.2	0.95	0.25
45	-	58	56.7	56.4	1.3	1.15	-	-	1.2	0.95	0.25
-	40	62	60.7	60.3	-	-	1.7	1.55	1.2	0.95	0.25
50	-	65	63.7	63.3	1.3	1.15	-	-	1.2	0.95	0.25
-	45	68	66.7	66.3	-	-	1.7	1.55	1.2	0.95	0.25
55	50	72	70.7	70.3	1.7	1.55	1.7	1.55	1.2	0.95	0.25
60	-	78	76.2	75.8	1.7	1.55	-	-	1.6	1.3	0.4
-	55	80	77.9	77.5	-	-	2.1	1.9	1.6	1.3	0.4
65	60	85	82.9	82.5	1.7	1.55	2.1	1.9	1.6	1.3	0.4
70	65	90	87.9	87.5	1.7	1.55	2.1	1.9	1.6	1.3	0.4
75	-	95	92.9	92.5	1.7	1.55	-	-	1.6	1.3	0.4
80	70	100	97.9	97.5	1.7	1.55	2.5	2.3	1.6	1.3	0.4
-	75	105	102.6	102.1	-	-	2.5	2.3	1.6	1.3	0.4
85	80	110	107.6	107.1	2.1	1.9	2.5	2.3	1.6	1.3	0.4
90	-	115	112.6	112.1	2.1	1.9	-	-	1.6	1.3	0.4
95	85	120	117.6	117.1	2.1	1.9	3.3	3.1	1.6	1.3	0.4
100	90	125	122.6	122.1	2.1	1.9	3.3	3.1	1.6	1.3	0.4
105	95	130	127.6	127.1	2.1	1.9	3.3	3.1	1.6	1.3	0.4
110	100	140	137.6	137.1	2.5	2.3	3.3	3.1	2.2	1.9	0.6
-	105	145	142.6	142.1	-	-	3.3	3.1	2.2	1.9	0.6
120	110	150	147.6	147.1	2.5	2.3	3.3	3.1	2.2	1.9	0.6
130	120	165	161.8	161.3	3.3	3.1	3.7	3.5	2.2	1.9	0.6
140	-	175	171.8	171.3	3.3	3.1	-	-	2.2	1.9	0.6
-	130	180	176.8	176.3	-	-	3.7	3.5	2.2	1.9	0.6
150	140	190	186.8	186.3	3.3	3.1	3.7	3.5	2.2	1.9	0.6
160	-	200	196.8	196.3	3.3	3.1	-	-	2.2	1.9	0.6

Remarks The minimum permissible chamfer dimensions r_N on the snap-ring-groove side of the outer rings are as follows:

Dimension series 18 : For outside diameters of 78 mm and less, use 0.3 mm chamfer.

For all others exceeding 78 mm, use 0.5 mm chamfer.

Dimension series 19 : For outside diameters of 24 mm and less, use 0.2 mm chamfer.

For 47 mm and less, use 0.3 mm chamfer.

For all others exceeding 47mm, use 0.5mm chamfer (However, for an outside diameter of 68 mm, use a 0.3 mm chamfer, which is not compliant with ISO 15).

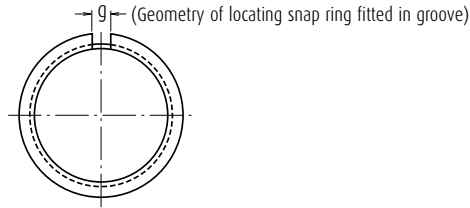
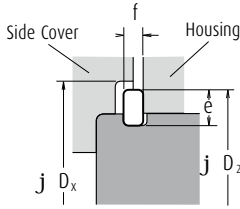

Units: mm

Locating Snap Ring Number	Locating Snap Ring				Side Cover		
	Cross Sectional Height		Thickness		Geometry of snap ring fitted in groove (Reference)		
	e		f		Slit Width	Stepped Bore Diameter (Reference)	
	max.	min.	max.	min.	g approx.	D ₂ max.	D _x min.
NR 1022	2.0	1.85	0.7	0.6	2	24.8	25.5
NR 1024	2.0	1.85	0.7	0.6	2	26.8	27.5
NR 1028	2.05	1.9	0.85	0.75	3	30.8	31.5
NR 1030	2.05	1.9	0.85	0.75	3	32.8	33.5
NR 1032	2.05	1.9	0.85	0.75	3	34.8	35.5
NR 1034	2.05	1.9	0.85	0.75	3	36.8	37.5
NR 1037	2.05	1.9	0.85	0.75	3	39.8	40.5
NR 1039	2.05	1.9	0.85	0.75	3	41.8	42.5
NR 1040	2.05	1.9	0.85	0.75	3	42.8	43.5
NR 1042	2.05	1.9	0.85	0.75	3	44.8	45.5
NR 1044	2.05	1.9	0.85	0.75	4	46.8	47.5
NR 1045	2.05	1.9	0.85	0.75	4	47.8	48.5
NR 1047	2.05	1.9	0.85	0.75	4	49.8	50.5
NR 1052	2.05	1.9	0.85	0.75	4	54.8	55.5
NR 1055	2.05	1.9	0.85	0.75	4	57.8	58.5
NR 1058	2.05	1.9	0.85	0.75	4	60.8	61.5
NR 1062	2.05	1.9	0.85	0.75	4	64.8	65.5
NR 1065	2.05	1.9	0.85	0.75	4	67.8	68.5
NR 1068	2.05	1.9	0.85	0.75	5	70.8	72
NR 1072	2.05	1.9	0.85	0.75	5	74.8	76
NR 1078	3.25	3.1	1.12	1.02	5	82.7	84
NR 1080	3.25	3.1	1.12	1.02	5	84.4	86
NR 1085	3.25	3.1	1.12	1.02	5	89.4	91
NR 1090	3.25	3.1	1.12	1.02	5	94.4	96
NR 1095	3.25	3.1	1.12	1.02	5	99.4	101
NR 1100	3.25	3.1	1.12	1.02	5	104.4	106
NR 1105	4.04	3.89	1.12	1.02	5	110.7	112
NR 1110	4.04	3.89	1.12	1.02	5	115.7	117
NR 1115	4.04	3.89	1.12	1.02	5	120.7	122
NR 1120	4.04	3.89	1.12	1.02	7	125.7	127
NR 1125	4.04	3.89	1.12	1.02	7	130.7	132
NR 1130	4.04	3.89	1.12	1.02	7	135.7	137
NR 1140	4.04	3.89	1.7	1.6	7	145.7	147
NR 1145	4.04	3.89	1.7	1.6	7	150.7	152
NR 1150	4.04	3.89	1.7	1.6	7	155.7	157
NR 1165	4.85	4.7	1.7	1.6	7	171.5	173
NR 1175	4.85	4.7	1.7	1.6	10	181.5	183
NR 1180	4.85	4.7	1.7	1.6	10	186.5	188
NR 1190	4.85	4.7	1.7	1.6	10	196.5	198
NR 1200	4.85	4.7	1.7	1.6	10	206.5	208

Boundary Dimensions and Identifying Numbers for Bearings

**Table 6.4 Dimensions of Snap Ring Grooves and Locating Snap Rings – (2)
Bearing of Diameter Series 0, 2, 3, and 4**

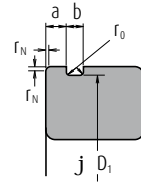

Applicable Bearings					Snap Ring Groove									
d					D	Snap Ring Groove Diameter		Snap Ring Groove Position				Snap Ring Groove Width		Radius of Bottom Corners
						D ₁		a				b		
Diameter Series					max.	min.	Bearing Diameter Series		max.	min.	max.	min.	max.	
0	2	3	4	0			2, 3, 4							
					max.	min.	max.	min.	max.	min.	max.	min.	max.	
10	-	-	-	26	24.5	24.25	1.35	1.19	-	-	1.17	0.87	0.2	
12	-	-	-	28	26.5	26.25	1.35	1.19	-	-	1.17	0.87	0.2	
-	10	9	8	30	28.17	27.91	-	-	2.06	1.9	1.65	1.35	0.4	
15	12	-	9	32	30.15	29.9	2.06	1.9	2.06	1.9	1.65	1.35	0.4	
17	15	10	-	35	33.17	32.92	2.06	1.9	2.06	1.9	1.65	1.35	0.4	
-	-	12	10	37	34.77	34.52	-	-	2.06	1.9	1.65	1.35	0.4	
-	17	-	-	40	38.1	37.85	-	-	2.06	1.9	1.65	1.35	0.4	
20	-	15	12	42	39.75	39.5	2.06	1.9	2.06	1.9	1.65	1.35	0.4	
22	-	-	-	44	41.75	41.5	2.06	1.9	-	-	1.65	1.35	0.4	
25	20	17	-	47	44.6	44.35	2.06	1.9	2.46	2.31	1.65	1.35	0.4	
-	22	-	-	50	47.6	47.35	-	-	2.46	2.31	1.65	1.35	0.4	
28	25	20	15	52	49.73	49.48	2.06	1.9	2.46	2.31	1.65	1.35	0.4	
30	-	-	-	55	52.6	52.35	2.08	1.88	-	-	1.65	1.35	0.4	
-	-	22	-	56	53.6	53.35	-	-	2.46	2.31	1.65	1.35	0.4	
32	28	-	-	58	55.6	55.35	2.08	1.88	2.46	2.31	1.65	1.35	0.4	
35	30	25	17	62	59.61	59.11	2.08	1.88	3.28	3.07	2.2	1.9	0.6	
-	32	-	-	65	62.6	62.1	-	-	3.28	3.07	2.2	1.9	0.6	
40	-	28	-	68	64.82	64.31	2.49	2.29	3.28	3.07	2.2	1.9	0.6	
-	35	30	20	72	68.81	68.3	-	-	3.28	3.07	2.2	1.9	0.6	
45	-	32	-	75	71.83	71.32	2.49	2.29	3.28	3.07	2.2	1.9	0.6	
50	40	35	25	80	76.81	76.3	2.49	2.29	3.28	3.07	2.2	1.9	0.6	
-	45	-	-	85	81.81	81.31	-	-	3.28	3.07	2.2	1.9	0.6	
55	50	40	30	90	86.79	86.28	2.87	2.67	3.28	3.07	3	2.7	0.6	
60	-	-	-	95	91.82	91.31	2.87	2.67	-	-	3	2.7	0.6	
65	55	45	35	100	96.8	96.29	2.87	2.67	3.28	3.07	3	2.7	0.6	
70	60	50	40	110	106.81	106.3	2.87	2.67	3.28	3.07	3	2.7	0.6	
75	-	-	-	115	111.81	111.3	2.87	2.67	-	-	3	2.7	0.6	
-	65	55	45	120	115.21	114.71	-	-	4.06	3.86	3.4	3.1	0.6	
80	70	-	-	125	120.22	119.71	2.87	2.67	4.06	3.86	3.4	3.1	0.6	
85	75	60	50	130	125.22	124.71	2.87	2.67	4.06	3.86	3.4	3.1	0.6	
90	80	65	55	140	135.23	134.72	3.71	3.45	4.9	4.65	3.4	3.1	0.6	
95	-	-	-	145	140.23	139.73	3.71	3.45	-	-	3.4	3.1	0.6	
100	85	70	60	150	145.24	144.73	3.71	3.45	4.9	4.65	3.4	3.1	0.6	
105	90	75	65	160	155.22	154.71	3.71	3.45	4.9	4.65	3.4	3.1	0.6	
110	95	80	-	170	163.65	163.14	3.71	3.45	5.69	5.44	3.8	3.5	0.6	
120	100	85	70	180	173.66	173.15	3.71	3.45	5.69	5.44	3.8	3.5	0.6	
-	105	90	75	190	183.64	183.13	-	-	5.69	5.44	3.8	3.5	0.6	
130	110	95	80	200	193.65	193.14	5.69	5.44	5.69	5.44	3.8	3.5	0.6	

Note (1) The locating snap rings and snap ring grooves of these bearings are not specified by ISO.

Remarks 1. The dimensions of these snap ring grooves are not applicable to bearings of dimension series 00, 82, and 83.

2. The minimum permissible chamfer dimension r_N on the snap-ring side of outer rings is 0.5 mm. However, for bearings of diameter series 0 having outside diameters 35 mm and below, it is 0.3 mm.

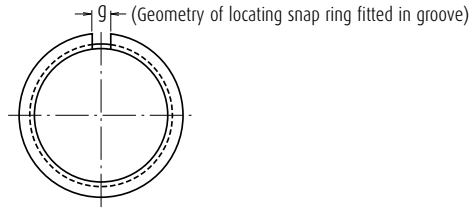
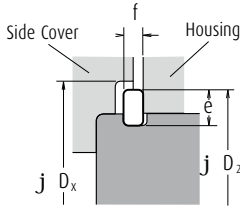

Units: mm

Locating Snap Ring Number	Locating Snap Ring				Side Cover		
	Cross Sectional Height		Thickness		Stepped Bore Diameter (Reference)		
	e		f		D _x		
	max.	min.	max.	min.	g approx.	D ₂ max.	D _x min.
NR 26 ⁽¹⁾	2.06	1.91	0.84	0.74	3	28.7	29.4
NR 28 ⁽¹⁾	2.06	1.91	0.84	0.74	3	30.7	31.4
NR 30	3.25	3.1	1.12	1.02	3	34.7	35.5
NR 32	3.25	3.1	1.12	1.02	3	36.7	37.5
NR 35	3.25	3.1	1.12	1.02	3	39.7	40.5
NR 37	3.25	3.1	1.12	1.02	3	41.3	42
NR 40	3.25	3.1	1.12	1.02	3	44.6	45.5
NR 42	3.25	3.1	1.12	1.02	3	46.3	47
NR 44	3.25	3.1	1.12	1.02	3	48.3	49
NR 47	4.04	3.89	1.12	1.02	4	52.7	53.5
NR 50	4.04	3.89	1.12	1.02	4	55.7	56.5
NR 52	4.04	3.89	1.12	1.02	4	57.9	58.5
NR 55	4.04	3.89	1.12	1.02	4	60.7	61.5
NR 56	4.04	3.89	1.12	1.02	4	61.7	62.5
NR 58	4.04	3.89	1.12	1.02	4	63.7	64.5
NR 62	4.04	3.89	1.7	1.6	4	67.7	68.5
NR 65	4.04	3.89	1.7	1.6	4	70.7	71.5
NR 68	4.85	4.7	1.7	1.6	5	74.6	76
NR 72	4.85	4.7	1.7	1.6	5	78.6	80
NR 75	4.85	4.7	1.7	1.6	5	81.6	83
NR 80	4.85	4.7	1.7	1.6	5	86.6	88
NR 85	4.85	4.7	1.7	1.6	5	91.6	93
NR 90	4.85	4.7	2.46	2.36	5	96.5	98
NR 95	4.85	4.7	2.46	2.36	5	101.6	103
NR 100	4.85	4.7	2.46	2.36	5	106.5	108
NR 110	4.85	4.7	2.46	2.36	5	116.6	118
NR 115	4.85	4.7	2.46	2.36	5	121.6	123
NR 120	7.21	7.06	2.82	2.72	7	129.7	131.5
NR 125	7.21	7.06	2.82	2.72	7	134.7	136.5
NR 130	7.21	7.06	2.82	2.72	7	139.7	141.5
NR 140	7.21	7.06	2.82	2.72	7	149.7	152
NR 145	7.21	7.06	2.82	2.72	7	154.7	157
NR 150	7.21	7.06	2.82	2.72	7	159.7	162
NR 160	7.21	7.06	2.82	2.72	7	169.7	172
NR 170	9.6	9.45	3.1	3	10	182.9	185
NR 180	9.6	9.45	3.1	3	10	192.9	195
NR 190	9.6	9.45	3.1	3	10	202.9	205
NR 200	9.6	9.45	3.1	3	10	212.9	215

Boundary Dimensions and Identifying Numbers for Bearings

6.2 Formulation of Bearing Numbers

Bearing numbers are alphanumeric combinations that indicate the bearing type, boundary dimensions, dimensional and running accuracies, internal clearance, and other related specifications. They consist of basic numbers and supplementary symbols. The boundary dimensions of commonly used bearings mostly conform to the organizational concept of ISO, and the bearing numbers of these standard bearings are specified by JIS B 1513 (Bearing Numbers for Rolling Bearings). Due to a need for more detailed classification, NSK uses auxiliary symbols other than those specified by JIS.

Bearing numbers consist of a basic number and supplementary symbols. The basic number indicates the bearing series (type) and the width and diameter series as shown in Table 6.5. Basic numbers, supplementary symbols, and the meanings of common numbers and symbols are listed in Table 6.6 (Pages A122 and A123). The contact angle symbols and other supplementary designations are shown in successive columns from left to right in Table 6.6. For reference, some examples of bearing designations are shown here:

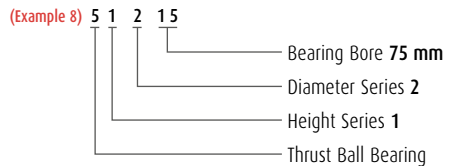
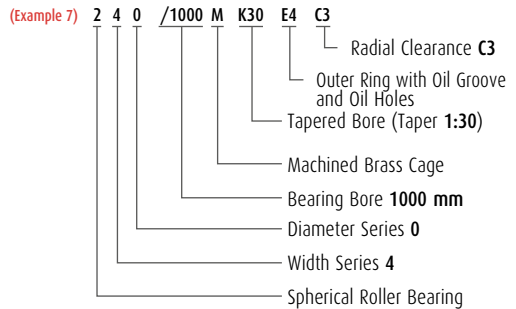
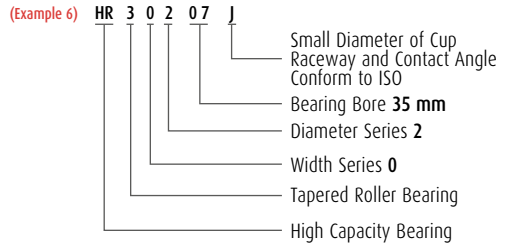
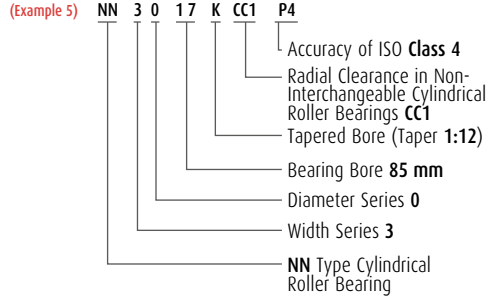
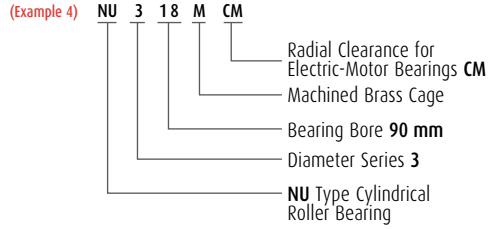
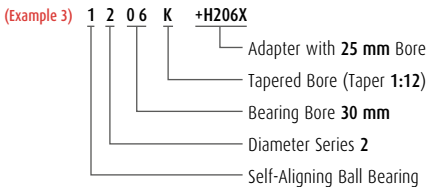
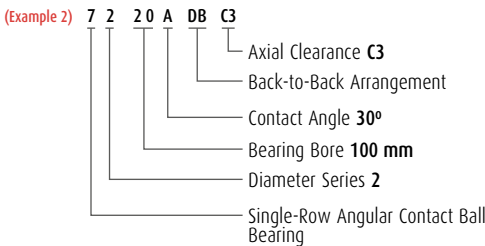
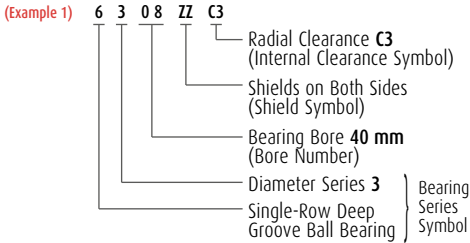

Table 6.5 Bearing Series Symbols

Bearing Type	Bearing Series Symbols	Type Symbols	Dimension Symbols	
			Width Symbols	Diameter Symbols
Single-Row Deep Groove Ball Bearings	68	6	(1)	8
	69	6	(1)	9
	60	6	(1)	0
	62	6	(0)	2
	63	6	(0)	3
Single-Row Angular Contact Ball Bearings	79	7	(1)	9
	70	7	(1)	0
	72	7	(0)	2
	73	7	(0)	3
Self-Aligning Ball Bearings	12	1	(0)	2
	13	1	(0)	3
	22	(1)	2	2
	23	(1)	2	3
Single-Row Cylindrical Roller Bearings	NU10	NU	1	0
	NU2	NU	(0)	2
	NU22	NU	2	2
	NU3	NU	(0)	3
	NU23	NU	2	3
	NU4	NU	(0)	4
	NJ2	NJ	(0)	2
	NJ22	NJ	2	2
	NJ3	NJ	(0)	3
	NJ23	NJ	2	3
	NJ4	NJ	(0)	4
	NUP2	NUP	(0)	2
	NUP22	NUP	2	2
	NUP3	NUP	(0)	3
	NUP23	NUP	2	3
	NUP4	NUP	(0)	4
	N10	N	1	0
	N2	N	(0)	2
	N3	N	(0)	3
	N4	N	(0)	4
NF2	NF	(0)	2	
NF3	NF	(0)	3	
NF4	NF	(0)	4	

Bearing Type	Bearing Series Symbols	Type Symbols	Dimension Symbols	
			Width Symbols or Height Symbols	Diameter Symbols
Double-Row Cylindrical Roller Bearings	NUU49	NNU	4	9
	NN30	NN	3	0
Needle Roller Bearings	NA48	NA	4	8
	NA49	NA	4	9
	NA59	NA	5	9
	NA69	NA	6	9
Tapered Roller Bearings	329	3	2	9
	320	3	2	0
	330	3	3	0
	331	3	3	1
	302	3	0	2
	322	3	2	2
	332	3	3	2
	303	3	0	3
323	3	2	3	
Spherical Roller Bearings	230	2	3	0
	231	2	3	1
	222	2	2	2
	232	2	3	2
	213 (1)	2	0	3
	223	2	2	3
Thrust Ball Bearings with Flat Seats	511	5	1	1
	512	5	1	2
	513	5	1	3
	514	5	1	4
	522	5	2	2
523	5	2	3	
524	5	2	4	
Spherical Thrust Roller Bearings	292	2	9	2
	293	2	9	3
	294	2	9	4

Note (1) Bearing Series Symbol 213 should logically be 203, but customarily it is numbered 213.

Remarks Numbers in () in the column of width symbols are usually omitted from the bearing number.

Boundary Dimensions and Identifying Numbers for Bearings

Table 6.6 Formulation of Bearing Numbers

Basic Numbers																	
Bearing Series Symbols (*)		Bore Number		Contact Angle Symbol		Internal Design Symbol		Material Symbol		Cage Symbol		External Features					
Symbol	Meaning	Symbol	Meaning	Symbol	Meaning	Symbol	Meaning	Symbol	Meaning	Symbol	Meaning	Symbol	Meaning				
68	Single-Row Deep Groove Ball Bearings	1	Bearing Bore 1mm	Angular Contact Ball Bearings		A	Internal Design Differs from Standard One	g	Case-Hardened Steel Used in Rings, Rolling Elements	M	Machined Brass Cage	Z	} Shield on One Side Only				
69	:	2	2	A	Standard Contact Angle of 30°	J	Smaller Diameter of Outer Ring Raceway, Contact Angle, and Outer Ring Width of Tapered Roller Bearings Conform to ISO 355	h	Stainless Steel Used in Rings, Rolling Elements	W	Pressed Steel Cage	ZS					
70		Single-row Angular Contact Ball Bearings	3	3	A5	Standard Contact Angle of 25°	For High Capacity Bearings					C	V	Without Cage	ZZ	} Shields on Both Sides	
72		:	9	9	B	Standard Contact Angle of 40°									E		Cylindrical Roller Bearings
73	Self-Aligning Ball Bearings		00	10	C	Standard Contact Angle of 15°		E	Spherical Thrust Roller Bearings	DU	Contact Rubber Seal on One Side Only						
12	:	01	12	Omitted			Less than 17°			E	Cylindrical Roller Bearings	T	Synthetic Resin Cage	V	Without Cage	DDU	Contact Rubber Seals on Both Sides
13		02	15		C	about 20°		E	Spherical Roller Bearings							V	Non-Contact Rubber Seal on One Side Only
22		03	17														
NA10	Cylindrical Roller Bearings	/22	22	C	about 28°	E	Spherical Thrust Roller Bearings	V	Without Cage	V	Non-Contact Rubber Seal on One Side Only						
NJ 2	:	/28	28									E	Cylindrical Roller Bearings	E	Spherical Thrust Roller Bearings	V	Without Cage
N 3		/32	32	E	Cylindrical Roller Bearings	E	Spherical Thrust Roller Bearings	V	Without Cage	V	Non-Contact Rubber Seal on One Side Only						
NN 30		Needle Roller Bearings	04(2)									20	E	Cylindrical Roller Bearings	E	Spherical Thrust Roller Bearings	V
NA48	:	05	25	E	Cylindrical Roller Bearings	E	Spherical Thrust Roller Bearings	V	Without Cage	V	Non-Contact Rubber Seal on One Side Only						
NA49		Tapered Roller Bearings	06									30	E	Cylindrical Roller Bearings	E	Spherical Thrust Roller Bearings	V
NA69		:	88	440	E	Cylindrical Roller Bearings	E	Spherical Thrust Roller Bearings	V	Without Cage	V	Non-Contact Rubber Seal on One Side Only					
320	Tapered Roller Bearings (2)		92	460									E	Cylindrical Roller Bearings	E	Spherical Thrust Roller Bearings	V
322	:	96	480	E	Cylindrical Roller Bearings	E	Spherical Thrust Roller Bearings	V	Without Cage	V	Non-Contact Rubber Seal on One Side Only						
323		Spherical Roller Bearings	/500									500	E	Cylindrical Roller Bearings	E	Spherical Thrust Roller Bearings	V
230		:	/530	530	E	Cylindrical Roller Bearings	E	Spherical Thrust Roller Bearings	V	Without Cage	V	Non-Contact Rubber Seal on One Side Only					
222	Thrust Ball Bearing with Flat Seats		/560	560									E	Cylindrical Roller Bearings	E	Spherical Thrust Roller Bearings	V
223	:	292	2 360	E	Cylindrical Roller Bearings	E	Spherical Thrust Roller Bearings	V	Without Cage	V	Non-Contact Rubber Seal on One Side Only						
511		Thrust Spherical Roller Bearings	/2 360									2 360	E	Cylindrical Roller Bearings	E	Spherical Thrust Roller Bearings	V
512		:	/2 500	2 500	E	Cylindrical Roller Bearings	E	Spherical Thrust Roller Bearings	V	Without Cage	V	Non-Contact Rubber Seal on One Side Only					
513	HR(4)		High Capacity Tapered Roller Bearings, and others										E	Cylindrical Roller Bearings	E	Spherical Thrust Roller Bearings	V
293	:	Symbols and Numbers Conform to JIS(5)		E	Cylindrical Roller Bearings	E	Spherical Thrust Roller Bearings	V	Without Cage	V	Non-Contact Rubber Seal on One Side Only						
294		Marked on Bearings	NSK Symbol									E	Cylindrical Roller Bearings	E	Spherical Thrust Roller Bearings	V	Without Cage
	Not Marked on Bearings	NSK Symbol		E	Cylindrical Roller Bearings	E	Spherical Thrust Roller Bearings	V	Without Cage	V	Non-Contact Rubber Seal on One Side Only						

- Notes**
- (1) Bearing Series Symbols conform to Table 6.5.
 - (2) For basic numbers of tapered roller bearings in ISO's new series, refer to Page B200.
 - (3) For Bearing Bore Numbers 04 through 96, five times the bore number gives the bore size (mm) (except double-direction thrust ball bearings).
 - (4) HR is prefix to bearing series symbols and it is NSK's original prefix.

Auxiliary Symbols

Symbol		Arrangement Symbol		Internal Clearance Symbol Preload Symbol		Tolerance Class Symbol		Special Specification Symbol		Spacer or Sleeve Symbol		Grease Symbol		
Symbol for Design of Rings		Symbol	Meaning	Symbol	Meaning (radial clearance)	Symbol	Meaning	Symbol	Meaning	Symbol	Meaning	Symbol	Meaning	
K	Tapered Bore of Inner Ring (Taper 1:12)	DB	Back-to-Back Arrangement	C1	Clearance Less than C2	Omitted	ISO Normal	Bearings treated for Dimensional Stabilization		+K	Bearings with Outer Ring Spacers	AS2	SHELL ALVANIA GREASE S2	
				C2	Clearance Less than CN		P6					ISO Class 6	ENS	ENS GREASE
K30	Tapered Bore of Inner Ring (Taper 1:30)	DF	Face-to-Face Arrangement	Omitted	CN Clearance	P6X	ISO Class 6X	X26	Working Temperature Lower than 150 °C		+L	Bearings with Inner Ring Spacers	NS7	NS HI-LUBE
				C3	Clearance Greater than CN		P5						ISO Class 5	X28
E	Notch or Lubricating Groove in Ring	DT	Tandem Arrangement	C4	Clearance Greater than C3	P4	ISO Class 4	X29	Working Temperature Lower than 250 °C		H	Adapter Designation	AH	Withdrawal Sleeve Designation
				C5	Clearance Greater than C4		P2							
E4	Lubricating Groove in Outside Surface and Holes in Outer Ring			CC1	Clearance Less than CC2	ABMA(?) Tapered roller bearing		Spherical Roller Bearings		HJ	Thrust Collar Designation			
N	Snap Ring Groove in Outer Ring			CC2	Clearance Less than CC	Omitted	Class 4	S11	Dimensional Stabilizing Treatment Working Temperature Lower than 200 °C					
		NR	Snap Ring Groove with Snap Ring in Outer Ring			CC	Normal Clearance	PN2	Class 2					
				CC3	Clearance Greater than CC	PN3	Class 3							
				CC4	Clearance Greater than CC3	PN0	Class 0							
				CC5	Clearance Greater than CC4	PN00	Class 00							
				MC1	Clearance Less than MC2									
				MC2	Clearance Less than MC3									
				MC3	Normal Clearance									
				MC4	Clearance Greater than MC3									
				MC5	Clearance Greater than MC4									
				MC6	Clearance Greater than MC5									
				CM	Clearance in Deep Groove Ball Bearings for Electric Motors									
				CT	Clearance in Cylindrical Roller Bearings for Electric Motors									
				CM	Clearance in Cylindrical Roller Bearings for Electric Motors									
				Preload of Angular Contact Ball Bearing										
				EL	Extra light Preload									
				L	Light Preload									
				M	Medium Preload									
				H	Heavy Preload									
Partially the same as JIS ⁽⁵⁾		Same as JIS ⁽⁵⁾		NSK Symbol	Partially the same as JIS ⁽⁵⁾ /BAS ⁽⁶⁾	Same as JIS ⁽⁵⁾		NSK Symbol, Partially the same as JIS ⁽⁵⁾						
In Principle, Marked on Bearings										Not Marked on Bearings				

- Notes
- ⁽⁵⁾ JIS : Japanese Industrial Standards.
 - ⁽⁶⁾ BAS : The Japan Bearing Industrial Association Standard.
 - ⁽⁷⁾ ABMA : The American Bearing Manufacturers Association.





7. BEARING TOLERANCES

7.1 Bearing Tolerance Standards	A 126
7.2 Selection of Accuracy Classes	A 151

7. Bearing Tolerances

7.1 Bearing Tolerance Standards

The tolerances for the boundary dimensions and running accuracy of rolling bearings are specified by ISO 492/199/582 (Accuracies of Rolling Bearings). Tolerances are specified for the following items:

Regarding bearing accuracy classes, besides ISO normal accuracy, as the accuracy improves there are Class 6X (for tapered roller bearings), Class 6, Class 5, Class 4, and Class 2, with Class 2 being the highest in ISO. The applicable accuracy classes for each bearing type and the correspondence of these classes are shown in Table 7.1.

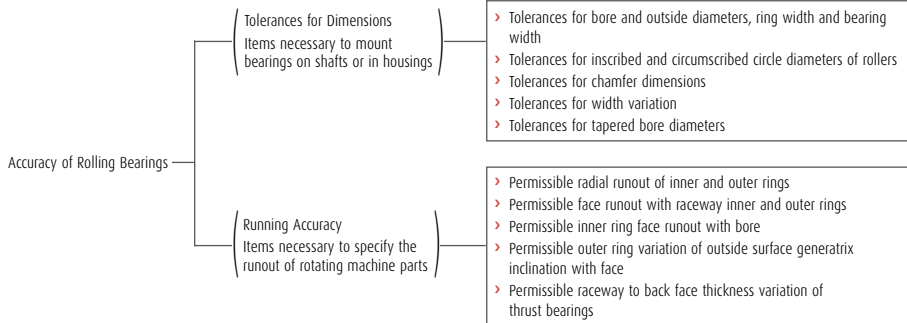

Table 7.1 Bearing Types and Tolerance Classes

Deep Groove Ball Bearings				ISO 492	Normal	-	Class 6	Class 5	Class 4	Class 2
Angular Contact Ball Bearings					Normal	-	Class 6	Class 5	Class 4	Class 2
Self-Aligning Ball Bearings					Normal	-	Class 6 Equivalent	Class 5 Equivalent	-	-
Cylindrical Roller Bearings					Normal	-	Class 6	Class 5	Class 4	Class 2
Needle Roller Bearings					Normal	-	Class 6	Class 5	Class 4	-
Spherical Roller Bearings					Normal	-	Class 6	Class 5	-	-
Tapered Roller Bearings	Metric Design			ISO 492	Normal	Class 6X	Class 6	Class 5	Class 4	-
	Inch Design			ANSI/AFBMA Std.19.2	Class 4	-	Class 2	Class 3	Class 0	Class 00
	J Series			ANSI/AFBMA Std.19.1	Class K	Class N	-	Class C	Class B	-
Magneto Bearings				BAS1061	Normal	-	Class 6	Class 5	-	-
Thrust Ball Bearings				ISO 199	Normal	-	Class 6	Class 5	Class 4	-
Thrust Roller Bearings					Normal	-	-	-	-	-
Thrust Spherical Roller Bearings					Normal	-	-	-	-	-
Equivalent standards (Reference)	JIS ⁽¹⁾			JIS B 1514,1536	Class 0	-	Class 6	Class 5	Class 4	Class 2
		Tapered Roller Bearings	Metric Design	JIS B 1514	Class 0	Class 6X	(Class 6)	Class 5	Class 4	-
	DIN ⁽²⁾			DIN620	P0	-	P6	P5	P4	P2
		Ball Bearings		ANSI/AFBMA Std.20	ABEC1	-	ABEC3	ABEC5	ABEC7	ABEC9
	Roller Bearings		RBEC1		-	RBEC3	RBEC5	-	-	
	ANSI/AFBMA ⁽³⁾	Instrument Ball Bearings		ANSI/AFBMA Std.12.2	-	-	-	Class 5P	Class 7P	Class 9P
		Tapered Roller Bearings	Metric Design	ANSI/AFBMA Std.19.1	Class K	Class N	-	Class C	Class B	Class A
BAS	Tapered Roller Bearings	Metric Design	Multi/Four-Row	BAS1002	Class 0	-	-	-	-	-

- Notes**
- (1) JIS : Japanese Industrial Standards
 - (2) DIN : Deutsches Institut fuer Normung
 - (3) ANSI/AFBMA : The American Bearing Manufacturers Association

Remarks The permissible limit of chamfer dimensions shall conform to Table 7.10 (Page A148 and A149), and the tolerances and permissible tapered bore diameters shall conform to Table 7.11 (Page A150 and A151).

Reference

Rough definitions of the items listed for Running Accuracy and their measuring methods are shown in Fig. 7.1, and they are described in detail in ISO 5593 (Rolling Bearings-Vocabulary) and JIS B 1515 (Rolling Bearings-Tolerances) and elsewhere.

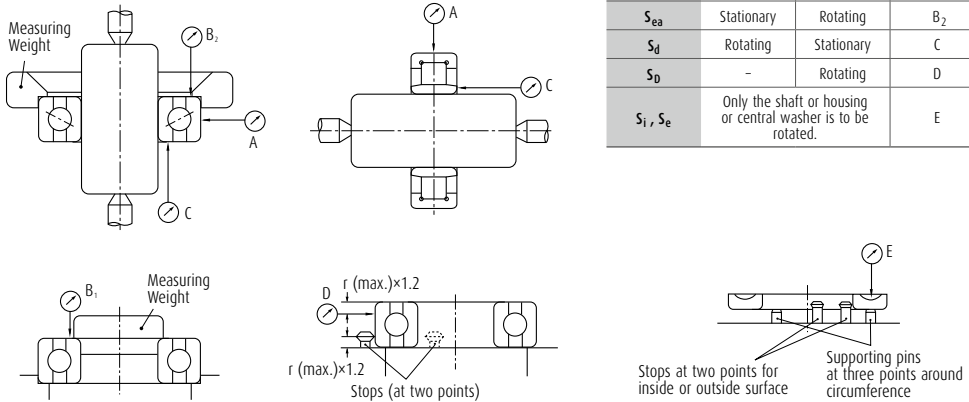

Fig. 7.1 Measuring Methods for Running Accuracy (summarized)

Supplementary Table

Running Accuracy	Inner Ring	Outer Ring	Dial Gauge
K_{ia}	Rotating	Stationary	A
K_{ea}	Stationary	Rotating	A
S_{ia}	Rotating	Stationary	B_1
S_{ea}	Stationary	Rotating	B_2
S_d	Rotating	Stationary	C
S_D	-	Rotating	D
S_i, S_e	Only the shaft or housing or central washer is to be rotated.		E

Symbols for Boundary Dimensions and Running Accuracy

d	Brg. bore dia., nominal	D	Brg. outside dia., nominal
$\&_{ds}$	Deviation of a single bore dia.	$\&_{Ds}$	Deviation of a single outside dia.
$\&_{dmp}$	Single plane mean bore dia. deviation	$\&_{Dmp}$	Single plane mean outside dia. Deviation
V_{dp}	Bore dia. Variation in a single radial plane	V_{Dp}	Outside dia. Variation in a single radial plane
V_{dmp}	Mean bore dia. Variation	V_{Dmp}	Mean outside dia. Variation
B	Inner ring width, nominal	C	Outer ring width, nominal
$\&_{Bs}$	Deviation of a single inner ring width	$\&_{Cs}$	Deviation of a single outer ring width
V_{Bs}	Inner ring width variation	V_{Cs}	Outer ring width variation
K_{ia}	Radial runout of assembled brg. inner ring	K_{ea}	Radial runout of assembled brg. outer ring
S_d	inner ring reference face (backface, where applicable) runout with bore	S_D	Variation of brg. outside surface generatrix inclination with outer ring reference face (backface)
S_{ia}	Assembled brg. inner ring face (back face) runout with raceway	S_{ea}	Assembled brg. outer ring face (backface) runout with raceway
S_i, S_e	Raceway to backface thickness variation of thrust brg.		

T Brg width, nominal
 $\&_{Ts}$ Deviation of the actual brg. width

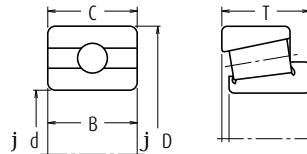

Bearing Tolerances

Table 7.2 Tolerances for Radial Bearings (excluding Tapered Roller Bearings)
Table 7.2.1 Tolerances for Inner Rings and Widths of Outer Rings

Nominal Bore Diameter d (mm)		& dmp ⁽²⁾										& ds ⁽²⁾			
		Normal		Class 6		Class 5		Class 4		Class 2		Class 4		Class 2	
												Diameter Series			
		high	low	high	low	high	low	high	low	high	low	0, 1, 2, 3, 4	high	low	
0.6 ⁽¹⁾	2.5	0	-8	0	-7	0	-5	0	-4	0	-2.5	0	-4	0	-2.5
2.5	10	0	-8	0	-7	0	-5	0	-4	0	-2.5	0	-4	0	-2.5
10	18	0	-8	0	-7	0	-5	0	-4	0	-2.5	0	-4	0	-2.5
18	30	0	-10	0	-8	0	-6	0	-5	0	-2.5	0	-5	0	-2.5
30	50	0	-12	0	-10	0	-8	0	-6	0	-2.5	0	-6	0	-2.5
50	80	0	-15	0	-12	0	-9	0	-7	0	-4	0	-7	0	-4
80	120	0	-20	0	-15	0	-10	0	-8	0	-5	0	-8	0	-5
120	150	0	-25	0	-18	0	-13	0	-10	0	-7	0	-10	0	-7
150	180	0	-25	0	-18	0	-13	0	-10	0	-7	0	-10	0	-7
180	250	0	-30	0	-22	0	-15	0	-12	0	-8	0	-12	0	-8
250	315	0	-35	0	-25	0	-18	-	-	-	-	-	-	-	-
315	400	0	-40	0	-30	0	-23	-	-	-	-	-	-	-	-
400	500	0	-45	0	-35	-	-	-	-	-	-	-	-	-	-
500	630	0	-50	0	-40	-	-	-	-	-	-	-	-	-	-
630	800	0	-75	-	-	-	-	-	-	-	-	-	-	-	-
800	1 000	0	-100	-	-	-	-	-	-	-	-	-	-	-	-
1 000	1 250	0	-125	-	-	-	-	-	-	-	-	-	-	-	-
1 250	1 600	0	-160	-	-	-	-	-	-	-	-	-	-	-	-
1 600	2 000	0	-200	-	-	-	-	-	-	-	-	-	-	-	-

Nominal Bore Diameter d (mm)		& Bs (or & cs) ⁽³⁾											
		Single Bearing						Combined Bearings ⁽⁴⁾					
		Normal Class 6		Class 5 Class 4		Class 2		Normal Class 6		Class 5 Class 4		Class 2	
		high	low	high	low	high	low	high	low	high	low	high	low
0.6 ⁽¹⁾	2.5	0	-40	0	-40	0	-40	-	-	0	-250	0	-250
2.5	10	0	-120	0	-40	0	-40	0	-250	0	-250	0	-250
10	18	0	-120	0	-80	0	-80	0	-250	0	-250	0	-250
18	30	0	-120	0	-120	0	-120	0	-250	0	-250	0	-250
30	50	0	-120	0	-120	0	-120	0	-250	0	-250	0	-250
50	80	0	-150	0	-150	0	-150	0	-380	0	-250	0	-250
80	120	0	-200	0	-200	0	-200	0	-380	0	-380	0	-380
120	150	0	-250	0	-250	0	-250	0	-500	0	-380	0	-380
150	180	0	-250	0	-250	0	-250	0	-500	0	-380	0	-380
180	250	0	-300	0	-300	0	-300	0	-500	0	-500	0	-500
250	315	0	-350	0	-350	-	-	0	-500	0	-500	-	-
315	400	0	-400	0	-400	-	-	0	-630	0	-630	-	-
400	500	0	-450	-	-	-	-	-	-	-	-	-	-
500	630	0	-500	-	-	-	-	-	-	-	-	-	-
630	800	0	-750	-	-	-	-	-	-	-	-	-	-
800	1 000	0	-1 000	-	-	-	-	-	-	-	-	-	-
1 000	1 250	0	-1 250	-	-	-	-	-	-	-	-	-	-
1 250	1 600	0	-1 600	-	-	-	-	-	-	-	-	-	-
1 600	2 000	0	-2 000	-	-	-	-	-	-	-	-	-	-

Notes

- (1) 0.6 mm is included in the group.
- (2) Applicable to bearings with cylindrical bores.
- (3) Tolerance for width deviation and tolerance limits for the width variation of the outer ring should be the same bearing. Tolerances for the width variation of the outer ring of Class 5, 4, and 2 are shown in Table 7.2.2.
- (4) Applicable to individual rings manufactured for combined bearings.
- (5) Applicable to ball bearings such as deep groove ball bearings, angular contact ball bearings, etc..

$V_{dp}(2)$											$V_{dmp}(2)$					
Normal			Class 6			Class 5		Class 4		Class 2		Normal	Class 6	Class 5	Class 4	Class 2
Diameter Series			Diameter Series			Diameter Series		Diameter Series		Diameter Series						
9	0, 1	2, 3, 4	9	0, 1	2, 3, 4	9	0, 1, 2, 3, 4	9	0, 1, 2, 3, 4	0, 1, 2, 3, 4						
max.			max.			max.		max.		max.		max.	max.	max.	max.	max.
10	8	6	9	7	5	5	4	4	3	2.5	6	5	3	2	1.5	
10	8	6	9	7	5	5	4	4	3	2.5	6	5	3	2	1.5	
10	8	6	9	7	5	5	4	4	3	2.5	6	5	3	2	1.5	
13	10	8	10	8	6	6	5	5	4	2.5	8	6	3	2.5	1.5	
15	12	9	13	10	8	8	6	6	5	2.5	9	8	4	3	1.5	
19	19	11	15	15	9	9	7	7	5	4	11	9	5	3.5	2	
25	25	15	19	19	11	10	8	8	6	5	15	11	5	4	2.5	
31	31	19	23	23	14	13	10	10	8	7	19	14	7	5	3.5	
31	31	19	23	23	14	13	10	10	8	7	19	14	7	5	3.5	
38	38	23	28	28	17	15	12	12	9	8	23	17	8	6	4	
44	44	26	31	31	19	18	14	-	-	-	26	19	9	-	-	
50	50	30	38	38	23	23	18	-	-	-	30	23	12	-	-	
56	56	34	44	44	26	-	-	-	-	-	34	26	-	-	-	
63	63	38	50	50	30	-	-	-	-	-	38	30	-	-	-	
-	-	-	-	-	-	-	-	-	-	-	-	-	-	-	-	
-	-	-	-	-	-	-	-	-	-	-	-	-	-	-	-	
-	-	-	-	-	-	-	-	-	-	-	-	-	-	-	-	
-	-	-	-	-	-	-	-	-	-	-	-	-	-	-	-	
-	-	-	-	-	-	-	-	-	-	-	-	-	-	-	-	
-	-	-	-	-	-	-	-	-	-	-	-	-	-	-	-	

7

Units : μm

V_{Bs} (or V_{Cs})					K_{ia}					S_d			$S_{ia}(5)$		
Inner Ring (or Outer Ring) (3)		Inner Ring			Normal	Class 6	Class 5	Class 4	Class 2	Class 5	Class 4	Class 2	Class 5	Class 4	Class 2
Normal	Class 6	Class 5	Class 4	Class 2	max.	max.	max.	max.	max.	max.	max.	max.	max.	max.	max.
max.	max.	max.	max.	max.											
12	12	5	2.5	1.5	10	5	4	2.5	1.5	7	3	1.5	7	3	1.5
15	15	5	2.5	1.5	10	6	4	2.5	1.5	7	3	1.5	7	3	1.5
20	20	5	2.5	1.5	10	7	4	2.5	1.5	7	3	1.5	7	3	1.5
20	20	5	2.5	1.5	13	8	4	3	2.5	8	4	1.5	8	4	2.5
20	20	5	3	1.5	15	10	5	4	2.5	8	4	1.5	8	4	2.5
25	25	6	4	1.5	20	10	5	4	2.5	8	5	1.5	8	5	2.5
25	25	7	4	2.5	25	13	6	5	2.5	9	5	2.5	9	5	2.5
30	30	8	5	2.5	30	18	8	6	2.5	10	6	2.5	10	7	2.5
30	30	8	5	4	30	18	8	6	5	10	6	4	10	7	5
30	30	10	6	5	40	20	10	8	5	11	7	5	13	8	5
35	35	13	-	-	50	25	13	-	-	13	-	-	15	-	-
40	40	15	-	-	60	30	15	-	-	15	-	-	20	-	-
50	45	-	-	-	65	35	-	-	-	-	-	-	-	-	-
60	50	-	-	-	70	40	-	-	-	-	-	-	-	-	-
70	-	-	-	-	80	-	-	-	-	-	-	-	-	-	-
80	-	-	-	-	90	-	-	-	-	-	-	-	-	-	-
100	-	-	-	-	100	-	-	-	-	-	-	-	-	-	-
120	-	-	-	-	120	-	-	-	-	-	-	-	-	-	-
140	-	-	-	-	140	-	-	-	-	-	-	-	-	-	-

Remarks

1. The cylindrical bore diameter "no-go side" tolerance limit (high) specified in this table does not necessarily apply within a distance of 1.2 times the chamfer dimension r (max.) from the ring face.
2. ABMA Std 20-1996: ABEC1-RBEC1, ABEC3-RBEC3, ABEC5-RBEC5, ABEC7-RBEC7, and ABEC9-RBEC9 are equivalent to Classes Normal, 6, 5, 4, and 2 respectively.

Bearing Tolerances

Table 7.2 Tolerances for Radial Bearings (excluding Tapered Roller Bearings)
Table 7.2.2 Tolerances for Outer Rings

Nominal Outside Diameter D (mm)		& Dmp										& Ds			
		Normal		Class 6		Class 5		Class 4		Class 2		Class 4		Class 2	
												Diameter Series			
												0, 1, 2, 3, 4			
over	incl.	high	low	high	low	high	low	high	low	high	low	high	low		
2.5 ⁽¹⁾	6	0	-8	0	-7	0	-5	0	-4	0	-2.5	0	-4	0	-2.5
6	18	0	-8	0	-7	0	-5	0	-4	0	-2.5	0	-4	0	-2.5
18	30	0	-9	0	-8	0	-6	0	-5	0	-4	0	-5	0	-4
30	50	0	-11	0	-9	0	-7	0	-6	0	-4	0	-6	0	-4
50	80	0	-13	0	-11	0	-9	0	-7	0	-4	0	-7	0	-4
80	120	0	-15	0	-13	0	-10	0	-8	0	-5	0	-8	0	-5
120	150	0	-18	0	-15	0	-11	0	-9	0	-5	0	-9	0	-5
150	180	0	-25	0	-18	0	-13	0	-10	0	-7	0	-10	0	-7
180	250	0	-30	0	-20	0	-15	0	-11	0	-8	0	-11	0	-8
250	315	0	-35	0	-25	0	-18	0	-13	0	-8	0	-13	0	-8
315	400	0	-40	0	-28	0	-20	0	-15	0	-10	0	-15	0	-10
400	500	0	-45	0	-33	0	-23	-	-	-	-	-	-	-	-
500	630	0	-50	0	-38	0	-28	-	-	-	-	-	-	-	-
630	800	0	-75	0	-45	0	-35	-	-	-	-	-	-	-	-
800	1 000	0	-100	0	-60	-	-	-	-	-	-	-	-	-	-
1 000	1 250	0	-125	-	-	-	-	-	-	-	-	-	-	-	-
1 250	1 600	0	-160	-	-	-	-	-	-	-	-	-	-	-	-
1 600	2 000	0	-200	-	-	-	-	-	-	-	-	-	-	-	-
2 000	2 500	0	-250	-	-	-	-	-	-	-	-	-	-	-	-

- Notes**
- (1) 2.5 mm is included in the group.
 - (2) Applicable only when a locating snap ring is not used.
 - (3) Applicable to ball bearings such as deep groove ball bearings and angular contact ball bearings.
 - (4) The tolerances for outer ring width variation of bearings of Classes Normal and 6 are shown in Table 7.2.1.
- Remarks**
1. The outside diameter "no-go side" tolerances (low) specified in this table do not necessarily apply within a distance of 1.2 times the chamfer dimension r (max.) from the ring face.
 2. ABMA Std 20-1996: ABEC1-RBEC1, ABEC3-RBEC3, ABEC5-RBEC5, ABEC7-RBEC7, and ABEC9-RBEC9 are equivalent to Classes Normal, 6, 5, 4, and 2 respectively.

V _{op} (²)												V _{omp} (²)						
Normal				Class 6				Class 5		Class 4		Class 2		Normal	Class 6	Class 5	Class 4	Class 2
Open Type		Shielded Sealed		Open Type		Shielded Sealed		Open Type		Open Type								
Diameter Series				Diameter Series				Diameter Series		Diameter Series		Diameter Series						
9	0, 1	2,3,4	2, 3, 4	9	0,1	2,3,4	0, 1, 2, 3, 4	9	0,1,2,3,4	9	0,1,2,3,4	0, 1, 2, 3, 4						
max.				max.				max.		max.		max.	max.	max.	max.	max.		
10	8	6	10	9	7	5	9	5	4	4	3	2.5	6	5	3	2	1.5	
10	8	6	10	9	7	5	9	5	4	4	3	2.5	6	5	3	2	1.5	
12	9	7	12	10	8	6	10	6	5	5	4	4	7	6	3	2.5	2	
14	11	8	16	11	9	7	13	7	5	6	5	4	8	7	4	3	2	
16	13	10	20	14	11	8	16	9	7	7	5	4	10	8	5	3.5	2	
19	19	11	26	16	16	10	20	10	8	8	6	5	11	10	5	4	2.5	
23	23	14	30	19	19	11	25	11	8	9	7	5	14	11	6	5	2.5	
31	31	19	38	23	23	14	30	13	10	10	8	7	19	14	7	5	3.5	
38	38	23	-	25	25	15	-	15	11	11	8	8	23	15	8	6	4	
44	44	26	-	31	31	19	-	18	14	13	10	8	26	19	9	7	4	
50	50	30	-	35	35	21	-	20	15	15	11	10	30	21	10	8	5	
56	56	34	-	41	41	25	-	23	17	-	-	-	34	25	12	-	-	
63	63	38	-	48	48	29	-	28	21	-	-	-	38	29	14	-	-	
94	94	55	-	56	56	34	-	35	26	-	-	-	55	34	18	-	-	
125	125	75	-	75	75	45	-	-	-	-	-	-	75	45	-	-	-	
-	-	-	-	-	-	-	-	-	-	-	-	-	-	-	-	-	-	
-	-	-	-	-	-	-	-	-	-	-	-	-	-	-	-	-	-	
-	-	-	-	-	-	-	-	-	-	-	-	-	-	-	-	-	-	
-	-	-	-	-	-	-	-	-	-	-	-	-	-	-	-	-	-	

7

Units : μm

Nominal Outside Diameter D (mm)		K _{ea}					S _D			S _{es} (²)			V _{cs} (⁴)		
		Normal	Class 6	Class 5	Class 4	Class 2	Class 5	Class 4	Class 2	Class 5	Class 4	Class 2	Class 5	Class 4	Class 2
over	incl.	max.	max.	max.	max.	max.	max.	max.	max.	max.	max.	max.	max.	max.	max.
2.5 (1)	6	15	8	5	3	1.5	8	4	1.5	8	5	1.5	5	2.5	1.5
6	18	15	8	5	3	1.5	8	4	1.5	8	5	1.5	5	2.5	1.5
18	30	15	9	6	4	2.5	8	4	1.5	8	5	2.5	5	2.5	1.5
30	50	20	10	7	5	2.5	8	4	1.5	8	5	2.5	5	2.5	1.5
50	80	25	13	8	5	4	8	4	1.5	10	5	4	6	3	1.5
80	120	35	18	10	6	5	9	5	2.5	11	6	5	8	4	2.5
120	150	40	20	11	7	5	10	5	2.5	13	7	5	8	5	2.5
150	180	45	23	13	8	5	10	5	2.5	14	8	5	8	5	2.5
180	250	50	25	15	10	7	11	7	4	15	10	7	10	7	4
250	315	60	30	18	11	7	13	8	5	18	10	7	11	7	5
315	400	70	35	20	13	8	13	10	7	20	13	8	13	8	7
400	500	80	40	23	-	-	15	-	-	23	-	-	15	-	-
500	630	100	50	25	-	-	18	-	-	25	-	-	18	-	-
630	800	120	60	30	-	-	20	-	-	30	-	-	20	-	-
800	1 000	140	75	-	-	-	-	-	-	-	-	-	-	-	-
1 000	1 250	160	-	-	-	-	-	-	-	-	-	-	-	-	-
1 250	1 600	190	-	-	-	-	-	-	-	-	-	-	-	-	-
1 600	2 000	220	-	-	-	-	-	-	-	-	-	-	-	-	-
2 000	2 500	250	-	-	-	-	-	-	-	-	-	-	-	-	-

Bearing Tolerances

Table 7.3 Tolerances for Metric Design Tapered Roller Bearings

Table 7.3.1 Tolerances for Inner Ring Bore Diameter and Running Accuracy

Nominal Outside Diameter d (mm)		& dmp						& ds		V _{Dp}				V _{dmp}			
		Normal Class 6X		Class 6 Class 5		Class 4		Class 4		Normal Class 6X	Class 6	Class 5	Class 4	Normal Class 6X	Class 6	Class 5	Class 4
over	incl.	high	low	high	low	high	low	high	low	max.	max.	max.	max.	max.	max.	max.	max.
10	18	0	-8	0	-7	0	-5	0	-5	8	7	5	4	6	5	5	4
18	30	0	-10	0	-8	0	-6	0	-6	10	8	6	5	8	6	5	4
30	50	0	-12	0	-10	0	-8	0	-8	12	10	8	6	9	8	5	5
50	80	0	-15	0	-12	0	-9	0	-9	15	12	9	7	11	9	6	5
80	120	0	-20	0	-15	0	-10	0	-10	20	15	11	8	15	11	8	5
120	180	0	-25	0	-18	0	-13	0	-13	25	18	14	10	19	14	9	7
180	250	0	-30	0	-22	0	-15	0	-15	30	22	17	11	23	16	11	8
250	315	0	-35	0	-25	0	-18	0	-18	35	-	-	-	26	-	-	-
315	400	0	-40	0	-30	0	-23	0	-23	40	-	-	-	30	-	-	-
400	500	0	-45	0	-35	0	-27	0	-27	-	-	-	-	-	-	-	-
500	630	0	-50	0	-40	-	-	-	-	-	-	-	-	-	-	-	-
630	800	0	-75	0	-60	-	-	-	-	-	-	-	-	-	-	-	-

- Remarks**
1. The bore diameter "no-go side" tolerances (high) specified in this table do not necessarily apply within a distance of 1.2 times the chamfer dimension r (max.) from the ring face.
 2. Some of these tolerances conform to the NSK Standard.

Table 7.3.2 Tolerances for Outer Ring Outside Diameter and Running Accuracy

Nominal Outside Diameter D (mm)		& Dmp						& Ds		V _{Dp}				V _{Dmp}			
		Normal Class 6X		Class 6 Class 5		Class 4		Class 4		Normal Class 6X	Class 6	Class 5	Class 4	Normal Class 6X	Class 6	Class 5	Class 4
over	incl.	high	low	high	low	high	low	high	low	max.	max.	max.	max.	max.	max.	max.	max.
18	30	0	-9	0	-8	0	-6	0	-6	9	8	6	5	7	6	5	4
30	50	0	-11	0	-9	0	-7	0	-7	11	9	7	5	8	7	5	5
50	80	0	-13	0	-11	0	-9	0	-9	13	11	8	7	10	8	6	5
80	120	0	-15	0	-13	0	-10	0	-10	15	13	10	8	11	10	7	5
120	150	0	-18	0	-15	0	-11	0	-11	18	15	11	8	14	11	8	6
150	180	0	-25	0	-18	0	-13	0	-13	25	18	14	10	19	14	9	7
180	250	0	-30	0	-20	0	-15	0	-15	30	20	15	11	23	15	10	8
250	315	0	-35	0	-25	0	-18	0	-18	35	25	19	14	26	19	13	9
315	400	0	-40	0	-28	0	-20	0	-20	40	28	22	15	30	21	14	10
400	500	0	-45	0	-33	0	-23	0	-23	45	-	-	-	34	-	-	-
500	630	0	-50	0	-38	0	-28	0	-28	50	-	-	-	38	-	-	-
630	800	0	-75	0	-45	-	-	-	-	-	-	-	-	-	-	-	-
800	1 000	0	-100	0	-60	-	-	-	-	-	-	-	-	-	-	-	-

- Remarks**
1. The outside diameter "no-go side" tolerances (low) specified in this table do not necessarily apply within a distance of 1.2 times the chamfer dimension r (max.) from the ring face.
 2. Some of these tolerances conform to the NSK Standard.

Units : μm

Normal Class 6X	K_{ia}			S_D		S_{ia}
	Class 6	Class 5	Class 4	Class 5	Class 4	Class 4
	max.	max.	max.	max.	max.	max.
15	7	3.5	2.5	7	3	3
18	8	4	3	8	4	4
20	10	5	4	8	4	4
25	10	5	4	8	5	4
30	13	6	5	9	5	5
35	18	8	6	10	6	7
50	20	10	8	11	7	8
60	25	13	10	13	8	10
70	30	15	12	15	10	14
70	35	18	14	19	13	17
85	40	20	-	22	-	-
100	45	22	-	27	-	-

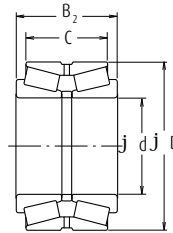
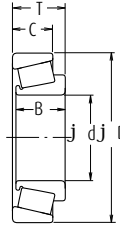

7

Units : μm

Normal Class 6X	K_{ea}			S_D		S_{ea}
	Class 6	Class 5	Class 4	Class 5	Class 4	Class 4
	max.	max.	max.	max.	max.	max.
18	9	6	4	8	4	5
20	10	7	5	8	4	5
25	13	8	5	8	4	5
35	18	10	6	9	5	6
40	20	11	7	10	5	7
45	23	13	8	10	5	8
50	25	15	10	11	7	10
60	30	18	11	13	8	10
70	35	20	13	13	10	13
80	40	23	15	15	11	15
100	50	25	18	18	13	18
120	60	30	-	20	-	-
120	75	35	-	23	-	-

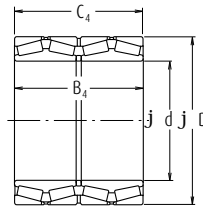

Bearing Tolerances

Table 7.3 Tolerances for Metric Design Tapered Roller Bearings
Table 7.3.3 Tolerances for Width, Overall Bearing Width, and Combined Bearing Width

Nominal Bore Diameter d (mm)		$\& B_S$						$\& C_S$						$\& T_S$					
		Normal Class 6		Class 6X		Class 5 Class 4		Normal Class 6		Class 6X		Class 5 Class 4		Normal Class 6		Class 6X		Class 5 Class 4	
over	incl.	high	low	high	low	high	low	high	low	high	low	high	low	high	low	high	low	high	low
10	18	0	-120	0	-50	0	-200	0	-120	0	-100	0	-200	+200	0	+100	0	+200	-200
18	30	0	-120	0	-50	0	-200	0	-120	0	-100	0	-200	+200	0	+100	0	+200	-200
30	50	0	-120	0	-50	0	-240	0	-120	0	-100	0	-240	+200	0	+100	0	+200	-200
50	80	0	-150	0	-50	0	-300	0	-150	0	-100	0	-300	+200	0	+100	0	+200	-200
80	120	0	-200	0	-50	0	-400	0	-200	0	-100	0	-400	+200	-200	+100	0	+200	-200
120	180	0	-250	0	-50	0	-500	0	-250	0	-100	0	-500	+350	-250	+150	0	+350	-250
180	250	0	-300	0	-50	0	-600	0	-300	0	-100	0	-600	+350	-250	+150	0	+350	-250
250	315	0	-350	0	-50	0	-700	0	-350	0	-100	0	-700	+350	-250	+200	0	+350	-250
315	400	0	-400	0	-50	0	-800	0	-400	0	-100	0	-800	+400	-400	+200	0	+400	-400
400	500	0	-450	-	-	0	-800	0	-450	-	-	0	-800	+400	-400	-	-	+400	-400
500	630	0	-500	-	-	0	-800	0	-500	-	-	0	-800	+500	-500	-	-	+500	-500
630	800	0	-750	-	-	0	-800	0	-750	-	-	0	-800	+600	-600	-	-	+600	-600

Remarks The effective width of an inner ring with rollers T_1 is defined as the overall bearing width of an inner ring with rollers combined with a master outer ring.
 The effective width of an outer ring T_2 is defined as the overall bearing width of an outer ring combined with a master inner ring with rollers.

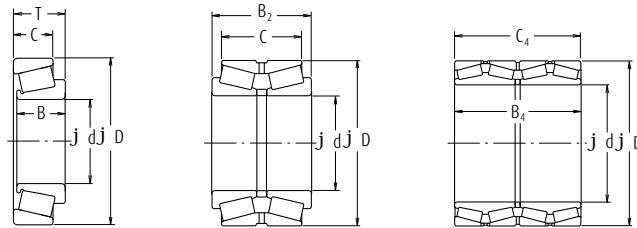

Units : μm

Ring Width with Rollers & T ₁₅				Outer Ring Effective Width Deviation & T ₂₅				Overall Combined Bearing Width Deviation & B ₂₅				Nominal Bore Diameter d (mm)	
Normal		Class 6X		Normal		Class 6X		All classes of double-row bearings		All classes of four-row bearings			
high	low	high	low	high	low	high	low	high	low	high	low	over	incl.
+100	0	+50	0	+100	0	+50	0	+200	-200	-	-	10	18
+100	0	+50	0	+100	0	+50	0	+200	-200	-	-	18	30
+100	0	+50	0	+100	0	+50	0	+200	-200	-	-	30	50
+100	0	+50	0	+100	0	+50	0	+300	-300	+300	-300	50	80
+100	-100	+50	0	+100	-100	+50	0	+300	-300	+400	-400	80	120
+150	-150	+50	0	+200	-100	+100	0	+400	-400	+500	-500	120	180
+150	-150	+50	0	+200	-100	+100	0	+450	-450	+600	-600	180	250
+150	-150	+100	0	+200	-100	+100	0	+550	-550	+700	-700	250	315
+200	-200	+100	0	+200	-200	+100	0	+600	-600	+800	-800	315	400
-	-	-	-	-	-	-	-	+700	-700	+900	-900	400	500
-	-	-	-	-	-	-	-	+800	-800	+1 000	-1 000	500	630
-	-	-	-	-	-	-	-	+1 200	-1 200	+1 500	-1 500	630	800

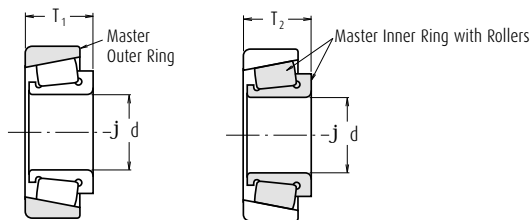

Bearing Tolerances

Table 7.4 Tolerances for Inch Design Tapered Roller Bearings

(Refer to page A126 Table 7.1 for the tolerance class "CLASS **" that is the tolerance classes of ANSI/ABMA.)

Table 7.4.1 Tolerances for Inner Ring Bore Diameter

Units : μm

Nominal Bore Diameter d				& d _s					
over		incl.		CLASS 4, 2		CLASS 3, 0		CLASS 00	
(mm)	1/25.4	(mm)	1/25.4	high	low	high	low	high	low
-	-	76.200	3.0000	+13	0	+13	0	+8	0
76.200	3.0000	266.700	10.5000	+25	0	+13	0	+8	0
266.700	10.5000	304.800	12.0000	+25	0	+13	0	-	-
304.800	12.0000	609.600	24.0000	+51	0	+25	0	-	-
609.600	24.0000	914.400	36.0000	+76	0	+38	0	-	-
914.400	36.0000	1 219.200	48.0000	+102	0	+51	0	-	-
1 219.200	48.0000	-	-	+127	0	+76	0	-	-

Table 7.4.2 Tolerances for Outer Ring Outside Diameter and Radial Runout of Inner and Outer Rings

Nominal Outside Diameter D				& D _s					
over		incl.		CLASS 4, 2		CLASS 3, 0		CLASS 00	
(mm)	1/25.4	(mm)	1/25.4	high	low	high	low	high	low
-	-	266.700	10.5000	+25	0	+13	0	+8	0
266.700	10.5000	304.800	12.0000	+25	0	+13	0	+8	0
304.800	12.0000	609.600	24.0000	+51	0	+25	0	-	-
609.600	24.0000	914.400	36.0000	+76	0	+38	0	-	-
914.400	36.0000	1 219.200	48.0000	+102	0	+51	0	-	-
1 219.200	48.0000	-	-	+127	0	+76	0	-	-

Table 7.4.3 Tolerances for Overall Width and Combined Width

Nominal Bore Diameter d				& T _s									
over		incl.		CLASS 4		CLASS 2		CLASS 3				CLASS 0, 00	
(mm)	1/25.4	(mm)	1/25.4	high	low	high	low	D ≤ 508.000 (mm)		D > 508.000 (mm)		high	low
-	-	101.600	4.0000	+203	0	+203	0	+203	-203	+203	-203	+203	-203
101.600	4.0000	304.800	12.0000	+356	-254	+203	0	+203	-203	+203	-203	+203	-203
304.800	12.0000	609.600	24.0000	+381	-381	+381	-381	+203	-203	+381	-381	-	-
609.600	24.0000	-	-	+381	-381	-	-	+381	-381	+381	-381	-	-

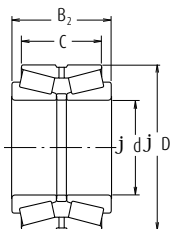
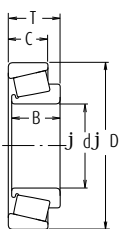

KBE

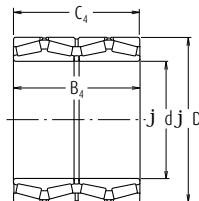

KV

Units : μm

K_{ia}, K_{ea}				
CLASS 4	CLASS 2	CLASS 3	CLASS 0	CLASS 00
max.	max.	max.	max.	max.
51	38	8	4	2
51	38	8	4	2
51	38	18	-	-
76	51	51	-	-
76	-	76	-	-
76	-	76	-	-

7

Units : μm

Double-Row Bearings (KBE Type)								Four-Row Bearings (KV Type)			
& B _{2s}								& B _{4s} & C _{4s}			
CLASS 4		CLASS 2		CLASS 3				CLASS 0, 00		CLASS 4, 3	
high	low	high	low	D ≤ 508.000 (mm)		D > 508.000 (mm)		high	low	high	low
+406	0	+406	0	+406	-406	+406	-406	+406	-406	+1 524	-1 524
+711	-508	+406	-203	+406	-406	+406	-406	+406	-406	+1 524	-1 524
+762	-762	+762	-762	+406	-406	+762	-762	-	-	+1 524	-1 524
+762	-762	-	-	+762	-762	+762	-762	-	-	+1 524	-1 524

Bearing Tolerances

Table 7.5 Tolerances for Magneto Bearings

Table 7.5.1 Tolerances for Inner Rings and Width of Outer Rings

Nominal Bore Diameter d (mm)		& d _{mp}						V _{d_p}			V _{d_{mp}}			& B _s (or & C _s) (1)			
		Normal		Class 6		Class 5		Normal	Class 6	Class 5	Normal	Class 6	Class 5	Normal Class 6		Class 5	
over	incl.	high	low	high	low	high	low	max.	max.	max.	max.	max.	max.	high	low	high	low
2.5	10	0	-8	0	-7	0	-5	6	5	4	6	5	3	0	-120	0	-40
10	18	0	-8	0	-7	0	-5	6	5	4	6	5	3	0	-120	0	-80
18	30	0	-10	0	-8	0	-6	8	6	5	8	6	3	0	-120	0	-120

Note (1) The width deviation and width variation of an outer ring is determined according to the inner ring of the same bearing.

Remarks The bore diameter "no-go side" tolerances (high) specified in this table do not necessarily apply within a distance of 1.2 times the chamfer dimension r (max.) from the ring face.

Table 7.5.2 Tolerances for Outer Rings

Nominal Outside Diameter D (mm)		& D _{mp}												V _{D_p}		
		Bearing Series E						Bearing Series EN						Normal	Class 6	Class 5
		Normal		Class 6		Class 5		Normal		Class 6		Class 5				
over	incl.	high	low	high	low	high	low	high	low	high	low	high	low	max.	max.	max.
6	18	+8	0	+7	0	+5	0	0	-8	0	-7	0	-5	6	5	4
18	30	+9	0	+8	0	+6	0	0	-9	0	-8	0	-6	7	6	5
30	50	+11	0	+9	0	+7	0	0	-11	0	-9	0	-7	8	7	5

Remarks The outside diameter "no-go side" tolerances (low) do not necessarily apply within a distance of 1.2 times the chamfer dimension r (max.) from the ring face.

Units : μm

V_{Bs} (or V_{Cs}) (1)		$\&T_S$		K_{ia}			S_d	S_{ia}
Normal Class 6	Class 5	Normal Class 5	Class 6	Normal	Class 6	Class 5	Class 5	Class 5
max.	max.	high	low	max.	max.	max.	max.	max.
15	5	+120	-120	10	6	4	7	7
20	5	+120	-120	10	7	4	7	7
20	5	+120	-120	13	8	4	8	8

Units : μm

V_{Dmp}			K_{ea}			S_{ea}	S_D
Normal	Class 6	Class 5	Normal	Class 6	Class 5	Class 5	Class 5
max.	max.	max.	max.	max.	max.	max.	max.
6	5	3	15	8	5	8	8
7	6	3	15	9	6	8	8
8	7	4	20	10	7	8	8

Bearing Tolerances

Table 7.6 Tolerances for Thrust Ball Bearings

Table 7.6.1 Tolerances for Shaft Washer Bore Diameter and Running Accuracy

Units : μm

Nominal Bore Diameter d or d_2 (mm)		$\&d_{mp}$ or $\&d_{2mp}$				V_{dP} or V_{d2P}		S_i or S_e (1)			
		Normal Class 6 Class 5		Class 4		Normal Class 6 Class 5	Class 4	Normal	Class 6	Class 5	Class 4
over	incl.	high	low	high	low	max.	max.	max.	max.	max.	max.
-	18	0	-8	0	-7	6	5	10	5	3	2
18	30	0	-10	0	-8	8	6	10	5	3	2
30	50	0	-12	0	-10	9	8	10	6	3	2
50	80	0	-15	0	-12	11	9	10	7	4	3
80	120	0	-20	0	-15	15	11	15	8	4	3
120	180	0	-25	0	-18	19	14	15	9	5	4
180	250	0	-30	0	-22	23	17	20	10	5	4
250	315	0	-35	0	-25	26	19	25	13	7	5
315	400	0	-40	0	-30	30	23	30	15	7	5
400	500	0	-45	0	-35	34	26	30	18	9	6
500	630	0	-50	0	-40	38	30	35	21	11	7
630	800	0	-75	0	-50	-	-	40	25	13	8
800	1 000	0	-100	-	-	-	-	45	30	15	-
1 000	1 250	0	-125	-	-	-	-	50	35	18	-

Note (1) For double-direction bearings, the thickness variation does not depend on the bore diameter d_2 , but on d for single-direction bearings with the same D in the same diameter series.
The thickness variation of housing washers, S_e , applies only to flat-seat thrust bearings.

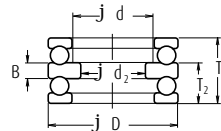
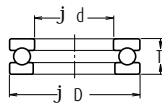
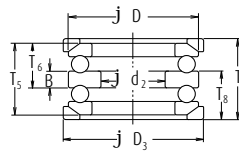
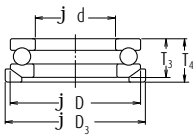

Table 7.6.2 Tolerances for Outside Diameter of Housing Washers and Aligning Seat Washers

Units : μm

Nominal Outside Diameter of Bearing or Aligning Seat Washer D or D_3 (mm)		& Dmp						V_{Dp}		Aligning Seat Washer Outside Diameter Deviation & D_{35}	
		Flat Seat Type				Aligning Seat Washer Type					
		Normal Class 6 Class 5	Class 4		Normal Class 6	Normal Class 6 Class 5	Class 4	Normal Class 6			
over	incl.	high	low	high	low	high	low	max.	max.	high	low
10	18	0	-11	0	-7	0	-17	8	5	0	-25
18	30	0	-13	0	-8	0	-20	10	6	0	-30
30	50	0	-16	0	-9	0	-24	12	7	0	-35
50	80	0	-19	0	-11	0	-29	14	8	0	-45
80	120	0	-22	0	-13	0	-33	17	10	0	-60
120	180	0	-25	0	-15	0	-38	19	11	0	-75
180	250	0	-30	0	-20	0	-45	23	15	0	-90
250	315	0	-35	0	-25	0	-53	26	19	0	-105
315	400	0	-40	0	-28	0	-60	30	21	0	-120
400	500	0	-45	0	-33	0	-68	34	25	0	-135
500	630	0	-50	0	-38	0	-75	38	29	0	-180
630	800	0	-75	0	-45	0	-113	55	34	0	-225
800	1 000	0	-100	-	-	-	-	75	-	-	-
1 000	1 250	0	-125	-	-	-	-	-	-	-	-
1 250	1 600	0	-160	-	-	-	-	-	-	-	-

7



Bearing Tolerances

Table 7.6.3 Tolerances for Thrust Ball Bearing Height and Central Washer Height

Units : μm

Nominal Bore Diameter $d^{(1)}$ (mm)		Flat Seat Type				Aligning Seat Washer Type				With Aligning Seat Washer				Height Deviation of Central Washer	
		$\&T_{15}$ or $\&T_{25}$		$\&T_{15}$		$\&T_{35}$ or $\&T_{65}$		$\&T_{55}$		$\&T_{45}$ or $\&T_{85}$		$\&T_{75}$		$\&B_5$	
		Normal, Class 6 Class 5, Class 4		Normal, Class 6 Class 5, Class 4		Normal Class 6		Normal Class 6		Normal Class 6		Normal Class 6		Normal, Class 6 Class 5, Class 4	
over	incl.	high	low	high	low	high	low	high	low	high	low	high	low	high	low
-	30	0	-75	+50	-150	0	-75	+50	-150	+50	-75	+150	-150	0	-50
30	50	0	-100	+75	-200	0	-100	+75	-200	+50	-100	+175	-200	0	-75
50	80	0	-125	+100	-250	0	-125	+100	-250	+75	-125	+250	-250	0	-100
80	120	0	-150	+125	-300	0	-150	+125	-300	+75	-150	+275	-300	0	-125
120	180	0	-175	+150	-350	0	-175	+150	-350	+100	-175	+350	-350	0	-150
180	250	0	-200	+175	-400	0	-200	+175	-400	+100	-200	+375	-400	0	-175
250	315	0	-225	+200	-450	0	-225	+200	-450	+125	-225	+450	-450	0	-200
315	400	0	-300	+250	-600	0	-300	+250	-600	+150	-275	+550	-550	0	-250

Note (1) For double-direction bearings, its classification depends on d for single-direction bearings with the same D in the same diameter series.

Remarks $\&T_{15}$ in the table is the deviation in the respective heights T in figures below.

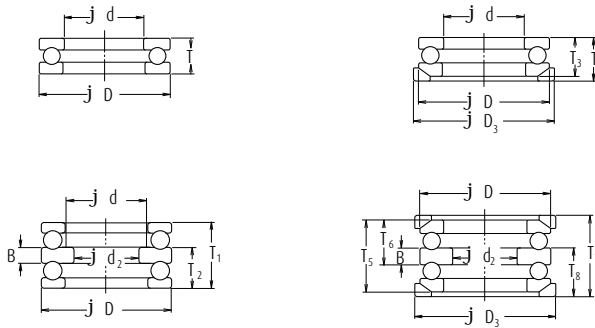

Table 7.7 Tolerances for Tapered Roller Thrust Bearings

Table 7.7.1 Tolerances for Bore Diameters of Shaft Washers and Height (Metric, Class Normal)

Units : μm

Nominal Bore Diameter d (mm)		$\&_{dmp}$		$\&_{T_S}$	
over	incl.	high	low	high	low
80	120	0	-20	0	-150
120	180	0	-25	0	-175
180	250	0	-30	0	-200
250	315	0	-35	0	-225
315	400	0	-40	0	-300
400	500	0	-45	0	-350
500	630	0	-50	0	-450
630	800	0	-75	0	-550
800	1 000	0	-100	0	-700
1 000	1 250	0	-125	0	-900
1 250	1 600	0	-160	0	-1 200

Table 7.7.2 Tolerances for Housing Washer Outside Diameters (Metric, Class Normal)

Units : μm

Nominal Outside Diameter D (mm)		$\&_{Dmp}$	
over	incl.	high	low
180	250	0	-30
250	315	0	-35
315	400	0	-40
400	500	0	-45
500	630	0	-50
630	800	0	-75
800	1 000	0	-100
1 000	1 250	0	-125
1 250	1 600	0	-160
1 600	2 000	0	-200

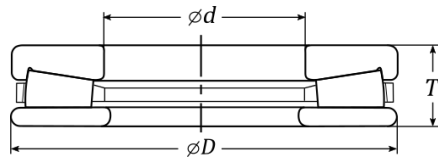
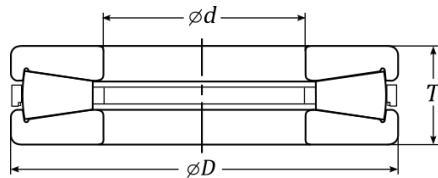

Bearing Tolerances

Table 7.7 Tolerances for Tapered Roller Thrust Bearings

Table 7.7.3 Tolerances for Bore Diameters of Shaft Washers and Height (Inch, Class 4)

Units : μm

Nominal Bore Diameter d (mm)				$\&_{dmp}$		$\&_{Ts}$	
over		incl.					
(mm)	(inch)	(mm)	(inch)	high	low	high	low
—	—	304.800	12.0000	+25	0	+381	-381
304.800	12.0000	609.600	24.0000	+51	0	+381	-381
609.600	24.0000	914.400	36.0000	+76	0	+381	-381
914.400	36.0000	1 219.200	48.0000	+102	0	+381	-381

Table 7.7.4 Tolerances for Bore Diameters of Shaft Washers and Height (Inch, Class 4)

Units : μm

Nominal Outside Diameter D (mm)				$\&_{Dmp}$	
over		incl.			
(mm)	(inch)	(mm)	(inch)	high	low
—	—	304.800	12.0000	+25	0
304.800	12.0000	609.600	24.0000	+51	0
609.600	24.0000	914.400	36.0000	+76	0
914.400	36.0000	1 219.200	48.0000	+102	0
1 219.200	48.0000	—	—	+127	0

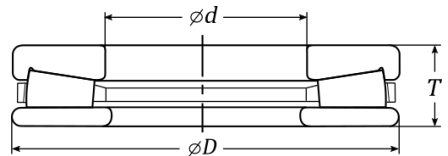
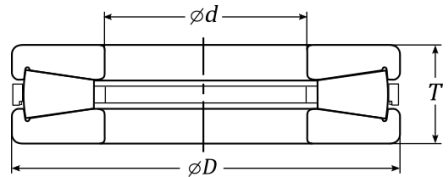

Table 7.8 Tolerances for Thrust Spherical Roller Bearings

Table 7.8.1 Tolerances for Bore Diameters of Shaft Rings and Height (Class Normal)

Units : μm

Nominal Bore Diameter d (mm)		$\&_{dmp}$		V_{dp}	Reference		
					S_d	$\&_{Ts}$	
over	incl.	high	low	max.	max.	high	low
50	80	0	-15	11	25	+150	-150
80	120	0	-20	15	25	+200	-200
120	180	0	-25	19	30	+250	-250
180	250	0	-30	23	30	+300	-300
250	315	0	-35	26	35	+350	-350
315	400	0	-40	30	40	+400	-400
400	500	0	-45	34	45	+450	-450

Remarks The bore diameter "no-go side" tolerances (high) specified in this table do not necessarily apply within a distance of 1.2 times the chamfer dimension r (max.) from the ring face.

Table 7.8.2 Tolerances for Housing Ring Diameter (Class Normal)

Units : μm

Nominal Outside Diameter D (mm)		$\&_{Dmp}$	
		high	low
over	incl.	high	low
120	180	0	-25
180	250	0	-30
250	315	0	-35
315	400	0	-40
400	500	0	-45
500	630	0	-50
630	800	0	-75
800	1 000	0	-100

Remarks The outside diameter "no-go side" tolerances (low) specified in this table do not necessarily apply within a distance of 1.2 times the chamfer dimension r (max.) from the ring face.

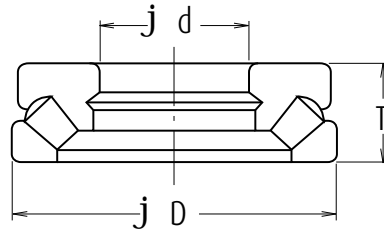

Bearing Tolerances

**Table 7.9 Tolerances of Instrument Ball Bearings (Inch design)
CLASS 5P, CLASS 7P, and CLASS 9P (ANSI/ABMA Equivalent)**

(1) Tolerances for Inner Rings and Width of Outer Rings

Nominal Bore Diameter d (mm)		$\& d_{mp}$				$\& d_s$				V_{dp}		V_{dmp}		$\& B_s$	
		CLASS 5P CLASS 7P		CLASS 9P		CLASS 5P CLASS 7P		CLASS 9P		CLASS 5P CLASS 7P	CLASS 9P	CLASS 5P CLASS 7P	CLASS 9P	Single Brgs. CLASS 5P CLASS 7P CLASS 9P	
		high	low	high	low	high	low	high	low	max.	max.	max.	max.	high	low
over	incl.														
-	10	0	-5.1	0	-2.5	0	-5.1	0	-2.5	2.5	1.3	2.5	1.3	0	-25.4
10	18	0	-5.1	0	-2.5	0	-5.1	0	-2.5	2.5	1.3	2.5	1.3	0	-25.4
18	30	0	-5.1	0	-2.5	0	-5.1	0	-2.5	2.5	1.3	2.5	1.3	0	-25.4

Note (1) Applicable to bearings for which the axial clearance (preload) is to be adjusted by combining two selected bearings.

Remarks For the CLASS 3P and the tolerances of Metric design Instrument Ball Bearings, it is advisable to consult NSK.

(2) Tolerances for Outer Rings

Nominal Outside Diameter D (mm)		$\& D_{mp}$				$\& D_s$				V_{Dp}			V_{Dmp}				
		CLASS 5P CLASS 7P		CLASS 9P		CLASS 5P CLASS 7P		CLASS 9P		CLASS 5P CLASS 7P		CLASS 9P	CLASS 5P CLASS 7P		CLASS 9P		
		high	low	high	low	high	low	high	low	high	low	max.	Shielded Sealed	Open	Open	Shielded Sealed	Open
over	incl.																
-	18	0	-5.1	0	-2.5	0	-5.1	+1	-6.1	0	-2.5	2.5	5.1	1.3	2.5	5.1	1.3
18	30	0	-5.1	0	-3.8	0	-5.1	+1	-6.1	0	-3.8	2.5	5.1	2	2.5	5.1	2
30	50	0	-5.1	0	-3.8	0	-5.1	+1	-6.1	0	-3.8	2.5	5.1	2	2.5	5.1	2

Notes (1) Applicable to flange width variation for flanged bearings.

(2) Applicable to flange back face.

Units : μm

(or $\& c_s$)		V_{Bs}			K_{ia}			S_{ia}			S_d		
Combined Brgs.(1)		CLASS 5P	CLASS 7P	CLASS 9P	CLASS 5P	CLASS 7P	CLASS 9P	CLASS 5P	CLASS 7P	CLASS9P	CLASS 5P	CLASS 7P	CLASS 9P
CLASS 5P	CLASS 7P												
high	low	max.	max.	max.	max.	max.	max.	max.	max.	max.	max.	max.	max.
0	-400	5.1	2.5	1.3	3.8	2.5	1.3	7.6	2.5	1.3	7.6	2.5	1.3
0	-400	5.1	2.5	1.3	3.8	2.5	1.3	7.6	2.5	1.3	7.6	2.5	1.3
0	-400	5.1	2.5	1.3	3.8	3.8	2.5	7.6	3.8	1.3	7.6	3.8	1.3

Units : μm

V_{Cs} (1)			S_D			K_{ea}			S_{ea}			Deviation of Flange Outside Diameter & d_{1s}		Deviation of Flange Width & c_{1s}		Flange Backface Runout with Raceway (?) S_{ea1}
CLASS 5P	CLASS 7P	CLASS 9P	CLASS 5P	CLASS 7P	CLASS 9P	CLASS 5P	CLASS 7P	CLASS 9P	CLASS 5P	CLASS 7P	CLASS 9P	CLASS 5P CLASS 7P		CLASS 5P CLASS 7P		CLASS 5P CLASS 7P
max.	max.	max.	max.	max.	max.	max.	max.	max.	max.	max.	max.	high	low	high	low	max.
5.1	2.5	1.3	7.6	3.8	1.3	5.1	3.8	1.3	7.6	5.1	1.3	0	-25.4	0	-50.8	7.6
5.1	2.5	1.3	7.6	3.8	1.3	5.1	3.8	2.5	7.6	5.1	2.5	0	-25.4	0	-50.8	7.6
5.1	2.5	1.3	7.6	3.8	1.3	5.1	5.1	2.5	7.6	5.1	2.5	0	-25.4	0	-50.8	7.6

7

Table 7.10 Chamfer Dimension Limits (for Metric Design Bearings)

Table 7.10.1 Chamfer Dimension Limits for Radial Bearings (excluding Tapered Roller Bearings)

Units : mm

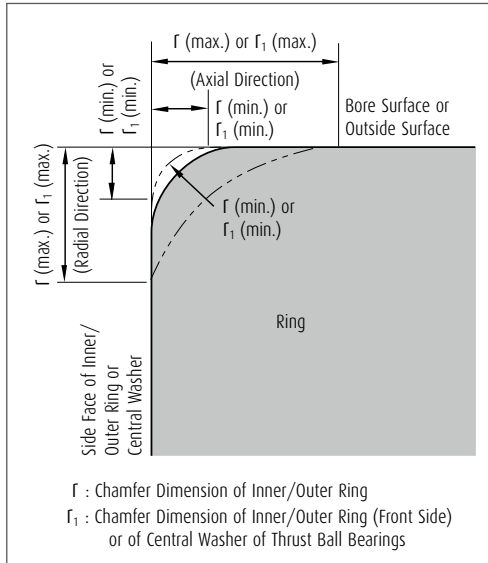

Remarks The precise shape of chamfer surfaces has not been specified but its profile in the axial plane shall not intersect an arc of radius r (min.) or r_1 (min.) touching the side face of an inner ring or central washer and bore surface, or the side face of an outer ring and outside surface.

Permissible Chamfer Dimension for Inner/Outer Rings Γ (min.) or Γ_1 (min.)	Nominal Bore Diameter d		Permissible Chamfer Dimension for Inner/Outer Rings r (max.) or r_1 (max.)		Reference
	over	incl.	Radial Direction	Axial Direction	Corner Radius of Shaft or Housing r_a max.
0.05	-	-	0.1	0.2	0.05
0.08	-	-	0.16	0.3	0.08
0.1	-	-	0.2	0.4	0.1
0.15	-	-	0.3	0.6	0.15
0.2	-	-	0.5	0.8	0.2
0.3	-	40	0.6	1	0.3
	40	-	0.8	1	
0.6	-	40	1	2	0.6
	40	-	1.3	2	
1	-	50	1.5	3	1
	50	-	1.9	3	
1.1	-	120	2	3.5	1
	120	-	2.5	4	
1.5	-	120	2.3	4	1.5
	120	-	3	5	
2	-	80	3	4.5	2
	80	220	3.5	5	
	220	-	3.8	6	
2.1	-	280	4	6.5	2
	280	-	4.5	7	
2.5	-	100	3.8	6	2
	100	280	4.5	6	
	280	-	5	7	
3	-	280	5	8	2.5
	280	-	5.5	8	
4	-	-	6.5	9	3
5	-	-	8	10	4
6	-	-	10	13	5
7.5	-	-	12.5	17	6
9.5	-	-	15	19	8
12	-	-	18	24	10
15	-	-	21	30	12
19	-	-	25	38	15

Remarks For bearings with nominal widths less than 2 mm, the value of r (max.) in the axial direction is the same as that in the radial direction.

Table 7.10.2 Chamfer Dimension Limits for Tapered Roller Bearings

Units : mm

Permissible Chamfer Dimension for Inner/Outer Rings r (min.)	Nominal Bore or Nominal Outside Diameter (1) d or D		Permissible Chamfer Dimension for Inner/Outer Rings r (max.)		Reference
			Radial Direction	Axial Direction	Corner Radius of Shaft or Housing r_a
	over	incl.			
0.15	-	-	0.3	0.6	0.15
0.3	-	40	0.7	1.4	0.3
	40	-	0.9	1.6	
0.6	-	40	1.1	1.7	0.6
	40	-	1.3	2	
1	-	50	1.6	2.5	1
	50	-	1.9	3	
1.5	-	120	2.3	3	1.5
	120	250	2.8	3.5	
	250	-	3.5	4	
2	-	120	2.8	4	2
	120	250	3.5	4.5	
	250	-	4	5	
2.5	-	120	3.5	5	2
	120	250	4	5.5	
	250	-	4.5	6	
3	-	120	4	5.5	2.5
	120	250	4.5	6.5	
	250	400	5	7	
	400	-	5.5	7.5	
4	-	120	5	7	3
	120	250	5.5	7.5	
	250	400	6	8	
5	-	180	6.5	8	4
	180	-	7.5	9	
	-	180	7.5	10	
6	-	180	7.5	10	5
	180	-	9	11	

Note (1) Inner Rings are classified by d and Outer Rings by D .

Table 7.10.3 Chamfer Dimension Limits for Thrust Bearings

Units : mm

Permissible Chamfer Dimension for Shaft (or Central)/Housing Washers r (min.) or r_1 (min.)	Permissible Chamfer Dimension for Shaft (or Central)/Housing Washers r (max.) or r_1 (max.)	Reference
		Corner Radius of Shaft or Housing r_a
		Radial and Axial Direction
0.05	0.1	0.05
0.08	0.16	0.08
0.1	0.2	0.1
0.15	0.3	0.15
0.2	0.5	0.2
0.3	0.8	0.3
0.6	1.5	0.6
1	2.2	1
1.1	2.7	1
1.5	3.5	1.5
2	4	2
2.1	4.5	2
3	5.5	2.5
4	6.5	3
5	8	4
6	10	5
7.5	12.5	6
9.5	15	8
12	18	10
15	21	12
19	25	15

7

Bearing Tolerances

Table 7.11 Tolerances for Tapered Bores (Class Normal)

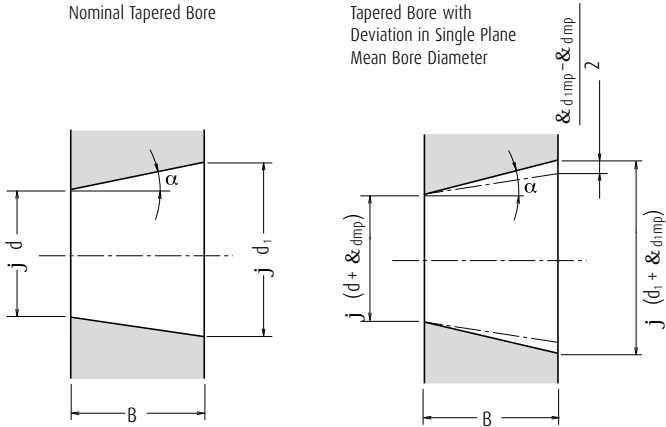

d : Nominal Bore Diameter
 d_1 : Theoretical Diameter of Larger End of Tapered Bore
 Taper 1:12 $d_1 = d + 1/12 B$ Taper 1:30 $d_1 = d + /30 B$
 $\&d_{mp}$: Single Plane Mean Bore Diameter Deviation in Theoretical Diameter of Smaller End of Bore
 $\&d_{1mp}$: Single Plane Mean Bore Diameter Deviation in Theoretical Diameter of Larger End of Bore
 V_{dp} : Bore diameter variation in a single radial plane
 B : Nominal Inner Ring width
 α : Half of Taper Angle of Tapered Bore

Taper 1:12
 $\alpha = 2^\circ 23' 9.4''$
 $= 2.38594^\circ$
 $= 0.041643 \text{ rad}$

Taper 1:30
 $\alpha = 57' 17.4''$
 $= 0.95484^\circ$
 $= 0.016665 \text{ rad}$

Taper 1 : 12

Units : μm

Nominal Bore Diameter d (mm)		$\&d_{mp}$		$\&d_{1mp} - \&d_{mp}$		$V_{dp} \text{ (1)(2)}$
over	incl.	high	low	high	low	max.
18	30	+33	0	+21	0	13
30	50	+39	0	+25	0	16
50	80	+46	0	+30	0	19
80	120	+54	0	+35	0	22
120	180	+63	0	+40	0	40
180	250	+72	0	+46	0	46
250	315	+81	0	+52	0	52
315	400	+89	0	+57	0	57
400	500	+97	0	+63	0	63
500	630	+110	0	+70	0	70
630	800	+125	0	+80	0	-
800	1 000	+140	0	+90	0	-
1 000	1 250	+165	0	+105	0	-
1 250	1 600	+195	0	+125	0	-

Notes (1) Applicable to all radial planes of tapered bores.
 (2) Not applicable to diameter series 7 and 8.

Taper 1 : 30

Units : μm

Nominal Bore Diameter d (mm)		$\&d_{mp}$		$\&d_{1mp} - \&d_{mp}$		$V_{dp} \text{ (1)(2)}$
over	incl.	high	low	high	low	max.
80	120	+20	0	+35	0	22
120	180	+25	0	+40	0	40
180	250	+30	0	+46	0	46
250	315	+35	0	+52	0	52
315	400	+40	0	+57	0	57
400	500	+45	0	+63	0	63
500	630	+50	0	+70	0	70

Notes (1) Applicable to all radial planes of tapered bores.
 (2) Not applicable to diameter series 7 and 8.

Remarks For values exceeding 630 mm, please contact NSK.

7.2 Selection of Accuracy Classes

For general applications, Class Normal tolerances are adequate in nearly all cases for satisfactory performance, but for the following applications, bearings having an accuracy class of 5,4 or higher are more suitable.

For reference, in Table 7.11, examples of applications and appropriate tolerance classes are listed for various bearing requirements and operating conditions.

Table 7.12 Typical Tolerance Classes for Specific Applications (Reference)

Bearing Requirement, Operating Conditions	Examples of Applications	Tolerance Classes
High running accuracy is required	VTR Drum Spindles	P5
	Magnetic Disk Spindles for Computers } Machine-Tool Main Spindles	P5, P4, P2
	Rotary Printing Presses	P5, P4, P2
	Rotary Tables of Vertical Presses, etc. }	P5
	Roll Necks of Cold Rolling } Mill Backup Rolls	P5, P4
	Slewing Bearings for Parabolic } Antennas	Higher than P4
Extra high speed is required	Dental Drills	CLASS 7P, CLASS 5P
	Gyroscopes	CLASS 7P, P4
	High Frequency Spindles	CLASS 7P, P4
	Superchargers	P5, P4
	Centrifugal Separators	P5, P4
	Main Shafts of Jet Engines	Higher than P4
Low torque and low torque variation are required	Gyroscope Gimbals	CLASS 7P, P4
	Servomechanisms	CLASS 7P, CLASS 5P
	Potentiometric Controllers	CLASS 7P

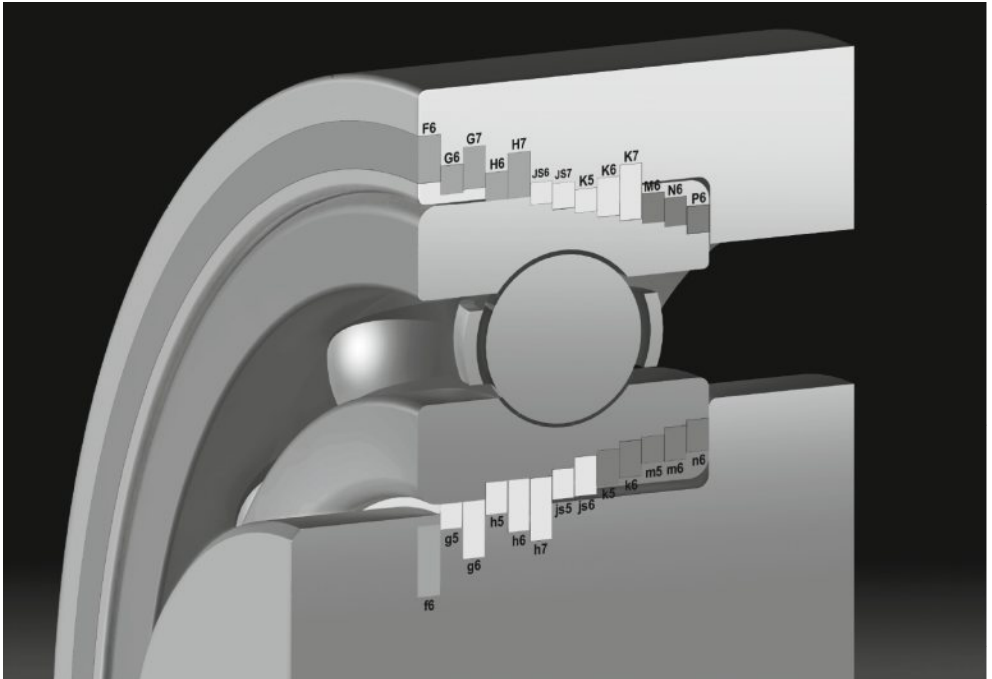

8. FITS AND INTERNAL CLEARANCES

8.1 Fits	A 154
8.1.1 Importance of Proper Fits	A 154
8.1.2 Selection of Fit	A 154
(1) Load Conditions and Fit	A 154
(2) Magnitude of Load and Interference	A 154
(3) Interference Variation Caused by Temperature Difference Between Bearing and Shaft or Housing	A 156
(4) Effective Interference and Finish of Shaft and Housing	A 156
(5) Fitting Stress and Ring Expansion and Contraction	A 156
(6) Surface Pressure and Maximum Stress on Fitting Surface	A 158
(7) Mounting and Withdrawal Loads	A 160
8.1.3 Recommended Fits	A 162
8.2 Bearing Internal Clearances	A 168
8.2.1 Internal Clearances and Their Standards	A 168
8.2.2 Selection of Bearing Internal Clearances	A 174
(1) Decrease in Radial Clearance Caused by Fitting and Residual Clearance	A 174
(2) Decrease in Radial Internal Clearance Caused by Temperature Differences between Inner and Outer Rings and Effective Clearance	A 175
8.3 Technical Data	A 176
8.3.1 Temperature Rise and Dimensional Change	A 176
8.3.2 Interference Deviation Due to Temperature Rise (Aluminum Housing, Plastic Housing)	A 178
8.3.3 Calculating Residual Internal Clearance after Mounting	A 180
8.3.4 Effect of Interference Fit on Bearing Raceways (Fit of Inner Ring)	A 182
8.3.5 Effect of Interference Fit on Bearing Raceways (Fit of Outer Ring)	A 184
8.3.6 Measuring Method of Internal Clearance of Combined Tapered Roller Bearings (Offset Measuring Method) ..	A 186
8.3.7 Internal Clearance Adjustment Method when Mounting a Tapered Roller Bearing	A 188

8. Fits and Internal Clearances

8.1 Fits

8.1.1 Importance of Proper Fits

In the case of a rolling bearing with the inner ring fitted to the shaft with only slight interference, a harmful circumferential slipping may occur between the inner ring and shaft. This slipping of the inner ring, which is called "creep", results in a circumferential displacement of the ring relative to the shaft if the interference fit is not sufficiently tight. When creep occurs, the fitted surfaces become abraded, causing wear and considerable damage to the shaft. Abnormal heating and vibration may also occur due to abrasive metallic particles entering the interior of the bearing.

It is important to prevent creep by having sufficient interference to firmly secure that ring which rotates to either the shaft or housing. Creep cannot always be eliminated using only axial tightening through the bearing ring faces. Generally, it is not necessary, however, to provide interference for rings subjected only to stationary loads. Fits are sometimes made without any interference for either the inner or outer ring, to accommodate certain operating conditions, or to facilitate mounting and dismounting. In this case, to prevent damage to the fitting surfaces due to creep, lubrication of other applicable methods should be considered.

8.1.2 Selection of Fit

(1) Load Conditions and Fit

The proper fit may be selected from Table 8.1 based on the load and operating conditions.

(2) Magnitude of Load and Interference

The interference of the inner ring is slightly reduced by the bearing load; therefore, the loss of interference should be estimated using the following equations:

$$\left. \begin{aligned} & \delta d_f = 0.08 \sqrt{\frac{d}{B}} F_r \times 10^{-3} \dots\dots\dots (N) \\ & \delta d_f = 0.25 \sqrt{\frac{d}{B}} F_r \times 10^{-3} \dots\dots \{kgf\} \end{aligned} \right\} \dots (8.1)$$

where δd_f : Interference decrease of inner ring (mm)

d : Bearing bore diameter (mm)

B : Nominal inner ring width (mm)

F_r : Radial load applied on bearing (N), {kgf}

Table 8.1 Loading Conditions and Fits

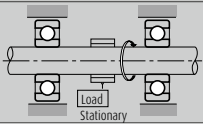
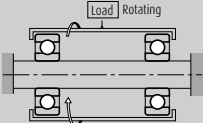
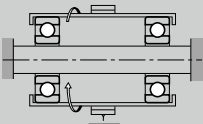
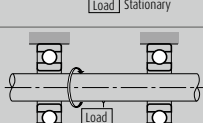
Load Application	Bearing Operation		Load Conditions	Fitting	
	Inner Ring	Outer Ring		Inner Ring	Outer Ring
	Rotating	Stationary	Rotating Inner Ring Load	Tight Fit	Loose Fit
	Stationary	Rotating	Stationary Outer Ring Load		
	Stationary	Rotating	Rotating Outer Ring Load	Loose Fit	Tight Fit
	Rotating	Stationary	Stationary Inner Ring Load		
Direction of load indeterminate due to variation of direction or unbalanced load	Rotating or Stationary	Rotating or Stationary	Direction of Load Indeterminate	Tight Fit	Tight Fit

Therefore, the effective interference Δd should be larger than the interference given by Equation (8.1).

However, in the case of heavy loads where the radial load exceeds 20% of the basic static load rating C_{0r} , under the operating condition, interference often becomes insufficient. Therefore, interference should be estimated using Equation (8.2):

$$\left. \begin{aligned} \Delta d &= 0.02 \frac{F_r}{B} \times 10^{-3} \dots\dots\dots (N) \\ \Delta d &= 0.2 \frac{F_r}{B} \times 10^{-3} \dots\dots\dots \{kgf\} \end{aligned} \right\} \dots\dots\dots (8.2)$$

where Δd : Effective interference (mm)

F_r : Radial load applied on bearing (N), {kgf}

B : Nominal inner ring width (mm)

Creep experiments conducted by NSK with NU219 bearings showed a linear relation between radial load (load at creep occurrence limit) and required effective interference.

It was confirmed that this line agrees well with the straight line of Equation (8.2).

For NU219, with the interference given by Equation (8.1) for loads heavier than $0.25 C_{0r}$, the interference becomes insufficient and creep occurs.

Generally speaking, the necessary interference for loads heavier than $0.25 C_{0r}$ should be calculated using Equation (8.2). When doing this, sufficient care should be taken to prevent excessive circumferential stress.

Calculation example

For NU219, $B=32$ (mm) and assume
 $F_r=98\ 100$ N {10 000 kgf}
 $C_{0r}=183\ 000$ N {18 600 kgf}

$$\frac{F_r}{C_{0r}} = \frac{98\ 100}{183\ 000} = 0.536 > 0.2$$

Therefore, the required effective interference is calculated using Equation (8.2).

$$\Delta d = 0.02 \times \frac{98\ 100}{32} \times 10^{-3} = 0.061 \text{ (mm)}$$

This result agrees well with Fig. 8.1.

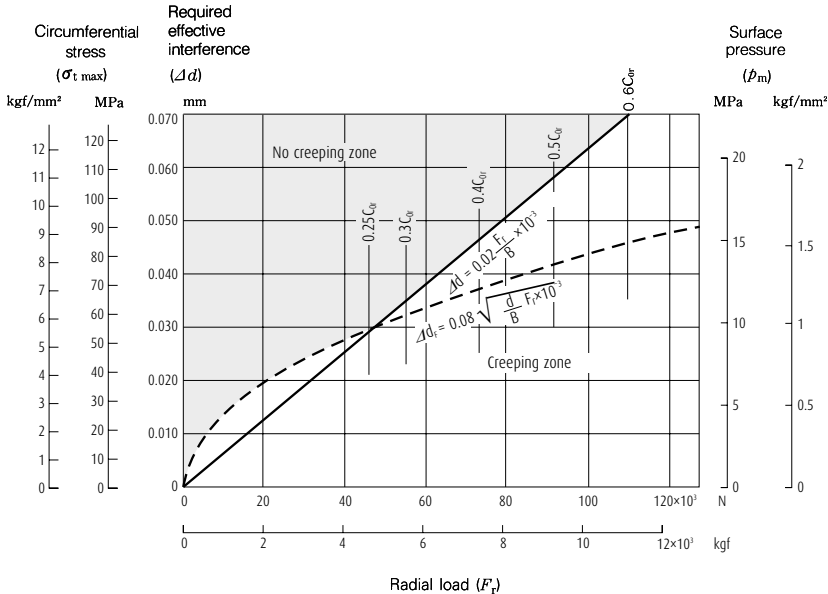

Fig. 8.1 Load and Required Effective Interference for Fit

Fits and Internal Clearances

(3) Interference Variation Caused by Temperature Difference between Bearing and Shaft or Housing

The effective interference decreases due to the increasing bearing temperature during operation. If the temperature difference between the bearing and housing is ΔT ($^{\circ}\text{C}$), then the temperature difference between the fitted surfaces of the shaft and inner ring is estimated to be about $(0.1-0.15) \Delta T$ in case that the shaft is cooled. The decrease in the interference of the inner ring due to this temperature difference Δd_T may be calculated using Equation (8.3):

$$\Delta d_T = (0.10 \text{ to } 0.15) \times \Delta T \cdot \alpha \cdot d \cdot 10^{-3} \dots\dots\dots (8.3)$$

where Δd_T : Decrease in interference of inner ring due to temperature difference (mm)

ΔT : Temperature difference between bearing interior and surrounding parts ($^{\circ}\text{C}$)

α : Coefficient of linear expansion of bearing steel = 12.5×10^{-6} ($1/^{\circ}\text{C}$)

d : Bearing nominal bore diameter (mm)

In addition, depending on the temperature difference between the outer ring and housing, or difference in their coefficients of linear expansion, the interference may increase.

(4) Effective Interference and Finish of Shaft and Housing

Since the roughness of fitted surfaces is reduced during fitting, the effective interference becomes less than the apparent interference. The amount of this interference decrease varies depending on the roughness of the surfaces and may be estimated using the following equations:

For grounded shafts $\Delta d = \frac{d}{d+2} \Delta d_a \dots\dots\dots (8.4)$

For machined shafts $\Delta d = \frac{d}{d+3} \Delta d_a \dots\dots\dots (8.5)$

where Δd : Effective interference (mm)

Δd_a : Apparent interference (mm)

d : Bearing nominal bore diameter (mm)

According to Equations (8.4) and (8.5), the effective interference of bearings with a bore diameter of 30 to 150 mm is about 95% of the apparent interference.

(5) Fitting Stress and Ring Expansion and Contraction

When bearings are mounted with interference on a shaft or in a housing, the rings either expand or contract and stress is produced. Excessive interference may damage the bearings; therefore, as a general guide, the maximum interference should be kept under approximately 7/10 000 of the shaft diameter.

The pressure between fitted surfaces, expansion or contraction of the rings, and circumferential stress may be calculated using the equations in Table 8.2.

Table 8.2 Fit Conditions

	Inner ring and shaft	Outer ring and housing
Surface pressure p_m (MPa) {kgf/mm ² }	<p>Hollow shaft</p> $p_m = \frac{\Delta d}{d} \frac{1}{\left[\frac{m_s - 1}{m_s E_s} \frac{m_i - 1}{m_i E_i} \right] + 2 \left[\frac{k_0^2}{E_s(1 - k_0^2)} + \frac{1}{E_i(1 - k^2)} \right]}$ <p>Solid shaft</p> $p_m = \frac{\Delta d}{d} \frac{1}{\left[\frac{m_s - 1}{m_s E_s} \frac{m_i - 1}{m_i E_i} + \frac{2}{E_i(1 - k^2)} \right]}$	<p>Housing outside diameter</p> $p_m = \frac{\Delta D}{D} \frac{1}{\left[\frac{m_e - 1}{m_e E_e} \frac{m_h - 1}{m_h E_h} \right] + 2 \left[\frac{h^2}{E_e(1 - h^2)} + \frac{1}{E_h(1 - h_0^2)} \right]}$
Expansion of inner ring raceway ΔD_i (mm) Contraction of outer ring raceway ΔD_e (mm)	$\Delta D_i = 2d \frac{p_m}{E_i} \frac{k}{1 - k^2}$ $= \Delta d \cdot k \frac{1 - k_0^2}{1 - k^2 k_0^2} \quad (\text{hollow shaft})$ $= \Delta d \cdot k \quad (\text{solid shaft})$	$\Delta D_e = 2D \frac{p_m}{E_e} \frac{h}{1 - h^2}$ $= \Delta D \cdot h \frac{1 - h_0^2}{1 - h^2 h_0^2}$
Maximum stress $\sigma_{t \max}$ (MPa) {kgf/mm ² }	<p>Circumferential stress at inner ring bore fitting surface is maximum.</p> $\sigma_{t \max} = p_m \frac{1 + k^2}{1 - k^2}$	<p>Circumferential stress at outer ring bore surface is maximum.</p> $\sigma_{t \max} = p_m \frac{2}{1 - h^2}$
Symbols	<p>d: Shaft diameter, inner ring bore d_0: Hollow shaft bore D: Inner ring raceway diameter $k = d/D_0$, $k_0 = d_0/d$ E_i: Inner ring Young's modulus, 208 000 MPa {21 200 kgf/mm²} E_s: Shaft Young's modulus m_i: Inner ring poisson's number, 3.33 m_s: Shaft poisson's number</p>	<p>D: Housing bore diameter, outer ring outside diameter D_0: Housing outside diameter D_e: Outer ring raceway diameter $h = D_e/D$, $h_0 = D_0/D_0$ E_e: Outer ring Young's modulus, 208 000 MPa {21 200 kgf/mm²} E_h: Housing Young's modulus m_h: Outer ring poisson's number, 3.33 m_i: Housing poisson's number</p>

Fits and Internal Clearances

(6) Surface Pressure and Maximum Stress on Fitting Surfaces

In order for rolling bearings to achieve their full life expectancy, their fitting must be appropriate. Usually for an inner ring, which is the rotating ring, an interference fit is chosen, and for a fixed outer ring, a loose fit is used. To select the fit, the magnitude of the load, the temperature differences among the bearing and shaft and housing, the material characteristics of the shaft and housing, the level of finish, the material thickness, and the bearing mounting/dismounting method must all be considered. If the interference is insufficient for the operating conditions, ring loosening, creep, fretting, heat generation, etc. may occur. If the interference is excessive, the ring may crack. The magnitude of the interference is usually satisfactory if it is set for the size of the shaft or housing listed in the bearing manufacturer's catalog. To determine the surface pressure and stress on the fitting surfaces, calculations can be made assuming a thick-walled cylinder with uniform internal and external pressures. To do this, the necessary equations are summarized in Table 8.2. For convenience in the fitting of bearing inner rings on solid steel shafts, which are the most common, the surface pressure and maximum stress are shown in Figs. 8.3 and 8.4.

Fig. 8.3 shows the surface pressure p_m and maximum stress $\sigma_{t \max}$ variations with shaft diameter when interference results from the mean values of the tolerance grade shaft and bearing bore tolerances. Fig. 8.4 shows the maximum surface pressure p_m and maximum stress $\sigma_{t \max}$ when maximum interference occurs. Fig. 8.4 is convenient for checking whether $\sigma_{t \max}$ exceeds the tolerances. The tensile strength of hardened bearing steel is about 1 570 to 1 960 MPa {160 to 200 kgf/mm²}. However, for safety, plan for a maximum fitting stress of 127 MPa {13 kgf/mm²}. For reference, the distributions of circumferential stress σ_t and radial stress σ_r in an inner ring are shown in Fig. 8.2.

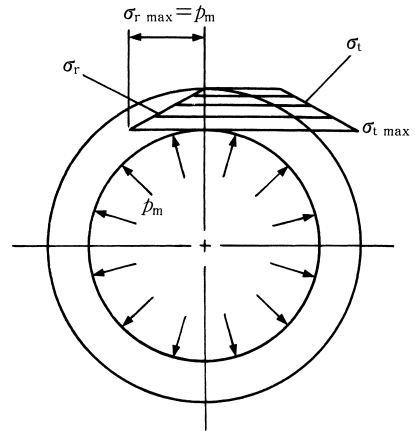

Fig. 8.2 Distribution of Circumferential Stress σ_t and Radial Stress σ_r

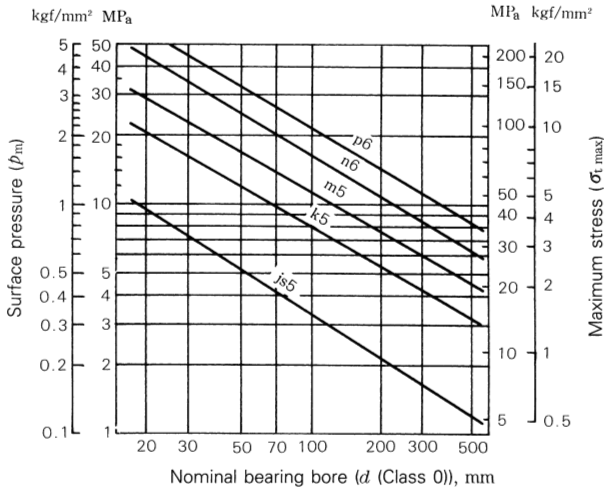

Fig. 8.3 Surface Pressure p_m and Maximum Stress $\sigma_{t,max}$ for Mean Interference in Various Tolerance Grades

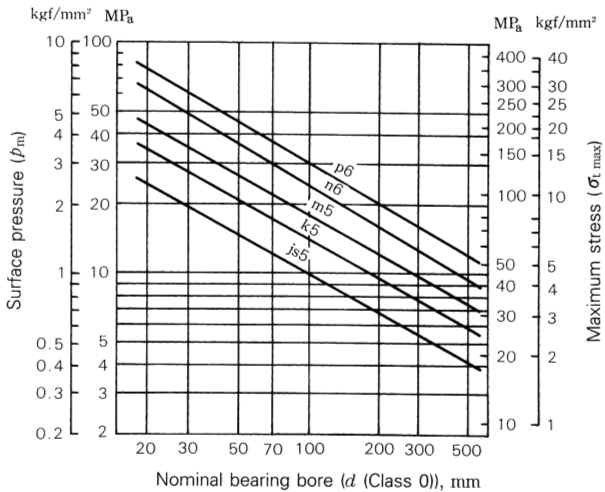

Fig. 8.4 Surface Pressure p_m and Maximum Stress $\sigma_{t,max}$ for Maximum Interference in Various Tolerance Grades

Fits and Internal Clearances

(7) Mounting and Withdrawal Loads

The push-up load needed to mount bearings on shafts or in a housing hole with interference can be obtained using the thick-walled cylinder theory. The mounting load (or withdrawal load) depends upon the contact area, surface pressure, and coefficient of friction between the fitting surfaces. The mounting load (or withdrawal load) K needed to mount inner rings on shafts is given by Equation (8.6).

$$K = \mu p_m \pi d B \text{ (N), \{kgf\}} \dots\dots\dots (8.6)$$

where μ : Coefficient of friction between fitting surfaces
 $\mu=0.12$ (for mounting)
 $\mu=0.18$ (for withdrawal)
 p_m : Surface pressure (MPa), {kgf/mm²}
 For example, inner ring surface pressure can be obtained using Table 8.2.

$$p_m = \frac{E}{2} \frac{\Delta d}{d} \frac{(1 - k^2)(1 - k_0^2)}{1 - k^2 k_0^2}$$

- d: Shaft diameter (mm)
- B: Bearing width (mm)
- Δd : Effective interference (mm)
- E: Young's modulus of steel (MPa), {kgf/mm²}
 $E=208\,000$ MPa {21\,200 kgf/mm²}
- k: Inner ring thickness ratio
 $k=d/D_i$
- D_i : Inner ring raceway diameter (mm)
- k_0 : Hollow shaft thickness ratio
 $k_0=d_0/d$
- d_0 : Bore diameter of hollow shaft (mm)

For solid shafts, $d_0=0$, consequently $k_0=0$. The value of k varies depending on the bearing type and size, but it usually ranges between $k=0.7$ and 0.9 . Assuming that $k=0.8$ and the shaft is solid, Equation (8.6) is:

$$K = \left. \begin{aligned} &= 118\,000 \mu \Delta d B \text{ (N)} \\ &= 12\,000 \mu \Delta d B \text{ \{kgf\}} \end{aligned} \right\} \dots\dots\dots (8.7)$$

Equation (8.7) is shown graphically in Fig. 8.5. The mounting and withdrawal loads for outer rings and housings have been calculated and the results are shown in Fig. 8.6. The actual mounting and withdrawal loads can become much higher than the calculated values if the bearing ring and shaft (or housing) are slightly misaligned or the load is applied unevenly to the circumference of the bearing ring hole. Consequently, the loads obtained from Figs. 8.5 and 8.6 should be considered only as guides when designing withdrawal tools, their strength should be five to six times higher than that indicated by the figures.

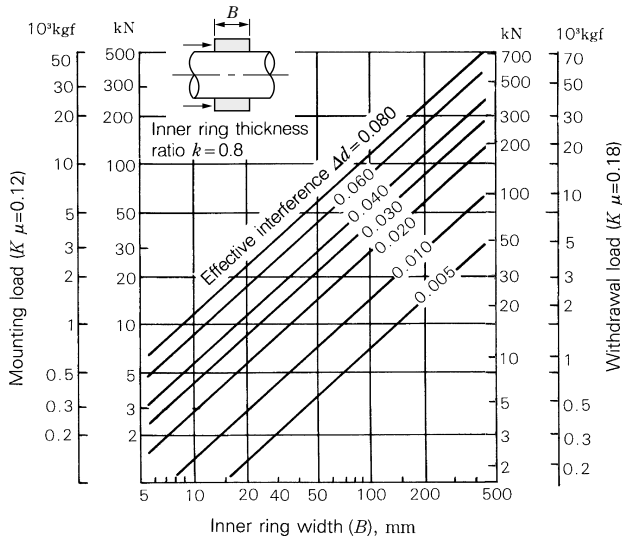

Fig. 8.5 Mounting and Withdrawal Loads for Inner Rings

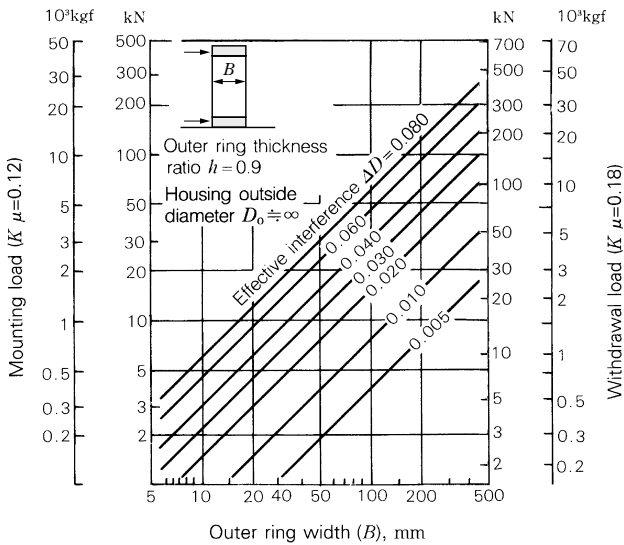

Fig. 8.6 Mounting and Withdrawal Loads for Outer Rings

Fits and Internal Clearances

8.1.3 Recommended Fits

As described previously, many factors, such as the characteristics and magnitude of bearing load, temperature differences, means of bearing mounting and dismounting, must be considered when selecting the proper fit.

If the housing is thin or the bearing is mounted on a hollow shaft, a tighter than usual fit is necessary. A split housing often deforms the bearing into an oval shape; therefore, a split housing should be avoided when a tight fit with the outer ring is required.

The fits of both the inner and outer rings should be tight in applications where the shaft is subjected to considerable vibration. The recommended fits for some common applications are shown in Table 8.3 to 8.8. In the case of unusual operating conditions, it is advisable to consult NSK. For the accuracy and surface finish of shafts and housings, please refer to Section 13.1 (Page A270).



Fits and Internal Clearances

Table 8.3 Fits of Radial Bearings with Shafts

Load Conditions		Examples	Shaft Diameter (mm)			Tolerance of Shaft	Remarks	
			Ball Brgs.	Cylindrical Roller Brgs., Tapered Roller Brgs.	Spherical Roller Brgs.			
Radial Bearings with Cylindrical Bores								
Rotating Outer Ring Load	Easy axial displacement of inner ring on shaft desirable.	Wheels on Stationary Axles	All Shaft Diameters			g6	Use g5 and h5 where accuracy is required. In case of large bearings, f6 can be used to allow easy axial movement.	
	Easy axial displacement of inner ring on shaft unnecessary	Tension Pulleys Rope Sheaves				h6		
Rotating Inner Ring Load or Direction of Load Indeterminate	Light Loads or Variable Loads (< 0.06C _r (¹))	Electrical Home Appliances Pumps, Blowers, Transport Vehicles, Precision Machinery, Machine Tools	< 18	-	-	js5	k6 and m6 can be used for single-row tapered roller bearings and single-row angular contact ball bearings instead of k5 and m5.	
			18 to 100	< 40	-	js6(j6)		
			100 to 200	40 to 140	-	k6		
	Normal Loads (0.06 to 0.13C _r (¹))	General Bearing Applications, Medium and Large Motors(²), Turbines, Pumps, Engine Main Bearings, Gears, Woodworking Machines	< 18	-	-	js5 or js6 (j5 or j6)		
			18 to 100	< 40	< 40	k5 or k6		
			100 to 140	40 to 100	40 to 65	m5 or m6		
			140 to 200	100 to 140	65 to 100	m6		
			200 to 280	140 to 200	100 to 140	n6		
			-	200 to 400	140 to 280	p6		
			-	-	280 to 500	r6		
	-	-	over 500	r7				
	Heavy Loads or Shock Loads (> 0.13C _r (¹))	Railway Axleboxes, Industrial Vehicles, Traction Motors, Construction Equipment, Crushers	-	50 to 140	50 to 100	n6		More than CN bearing internal clearance is necessary.
			-	140 to 200	100 to 140	p6		
-			over 200	140 to 200	r6			
-			-	200 to 500	r7			
Axial Loads Only			All Shaft Diameters			js6 (j6)	-	
Radial Bearings with Tapered Bores and Sleeves								
All Types of Loading		General bearing Applications, Railway Axleboxes	All Shaft Diameters			h9/IT5(²)	IT5 and IT7 mean that the deviation of the shaft from its true geometric form, e. g. roundness and cylindricity should be within the tolerances of IT5 and IT7 respectively.	
		Transmission Shafts, Woodworking Spindles				h10/IT7(²)		

- Notes**
- (¹) C_r represents the basic load rating of the bearing.
 - (²) Refer to Appendix Table 11 on page C016 for the values of standard tolerance grades IT.
 - (³) Refer to Tables 8.14.1 and 8.14.2 for the recommended fits of shafts used in electric motors for deep groove ball bearings with bore diameters ranging from 10 mm to 160 mm, and for cylindrical roller bearings with bore diameters ranging from 24 mm to 200 mm.

Remarks This table is applicable only to solid steel shafts.

Table 8.4 Fits of Thrust Bearings with Shafts

Load Conditions		Examples	Shaft Diameter (mm)	Tolerance of Shaft	Remarks
Central Axial Load Only		Main Shafts of Lathes	All Shaft Diameters	h6 or js6 (j6)	
Combined Radial and Axial Loads (Spherical Thrust Roller Bearings)	Stationary Inner Ring Load	Cone Crushers	All Shaft Diameters	js6 (j6)	
	Rotating Inner Ring Load or Direction of Load Indeterminate	Paper Pulp Refiners, Plastic Extruders	< 200	k6	
			200 to 400	m6	
			over 400	n6	

Table 8.5 Fits of Radial Bearings with Housings

Load Conditions			Examples	Tolerances for Housing Bores	Axial Displacement of Outer Ring	Remarks
Solid Housings	Rotating Outer Ring Load	Heavy Loads on Bearing in Thin-Walled Housing or Heavy Shock Loads	Automotive Wheel Hubs (Roller Bearings) Crane Travelling Wheels	P7	Impossible	-
		Normal or Heavy Loads	Automotive Wheel Hubs (Ball Bearings) Vibrating Screens	N7		
		Light or Variable Loads	Conveyor Rollers Rope Sheaves Tension Pulleys	M7		
Direction of Load Indeterminate		Heavy Shock Loads	Traction Motors		Generally Impossible	If axial displacement of the outer ring is not required.
		Normal or Heavy Loads	Pumps Crankshaft Main Bearings Medium and Large Motors ⁽¹⁾	K7		
Solid or Split Housings	Rotating Inner Ring Load	Normal or Light Loads	Plummer Blocks	H8	Easily possible	-
		Loads of All kinds	General Bearing Applications, Railway Axleboxes	H7		
		High Temperature Rise of Inner Ring Through Shaft	Paper Dryers	G7		
Solid Housing	Direction of Load Indeterminate	Accurate Running Desirable under Normal or Light Loads	Grinding Spindle Rear Ball Bearings High Speed Centrifugal Compressor Free Bearings	JS6 (J6)	Possibly	-
			Grinding Spindle Front Ball Bearings High Speed Centrifugal Compressor Fixed Bearings	K6		
	Rotating Inner Ring Load	Accurate Running and High Rigidity Desirable under Variable Loads	Cylindrical Roller Bearings for Machine Tool Main Spindle	M6 or N6	Impossible	For heavy loads, interference fit tighter than K is used. When high accuracy is required, very strict tolerances should be used for fitting.
	Minimum noise is required	Electrical Home Appliances	H6	Easily Possible	-	

Note (1) Refer to Tables 8.14.1 and 8.14.2 for the recommended fits of housing bores of deep groove ball bearings and cylindrical roller bearings for electric motors.

- Remarks**
1. This table is applicable to cast iron and steel housings. For housings made of light alloys, the interference should be tighter than those in this table.
 2. Refer to the introductory section of the bearing dimension tables (blue pages) for special fits such as drawn cup needle roller bearings.

Table 8.6 Fits of Thrust Bearings with Housings

Load Conditions		Bearing Types	Tolerances for Housing Bores	Remarks
Axial Loads Only		Thrust Ball Bearings	Clearance over 0.25 mm	For General Applications
			H8	When precision is required
		Spherical Thrust Roller Bearings Steep Angle Tapered Roller Bearings	Outer ring has radial clearance.	When radial loads are sustained by other bearings.
Combined Radial and Axial Loads	Stationary Outer Ring Loads	Spherical Thrust Roller Bearings	H7 or JS7 (J7)	-
	Rotating Outer Ring Loads or Direction of Load Indeterminate		K7	Normal Loads
			M7	Relatively Heavy Radial Loads

Fits and Internal Clearances

Table 8.7 Fits of Inch Design Tapered Roller Bearings with Shafts

(1) Bearings of Precision Classes 4 and 2

Units : μm

Operating Conditions		Nominal Bore Diameters d				Bore Diameter Tolerances & ds		Shaft Diameter Tolerances		Remarks
		over		incl.		high	low	high	low	
		(mm)	1/25.4	(mm)	1/25.4					
Rotating Inner Ring Loads	Normal Loads	-		76.200	3.0000	+13	0	+38	+25	For bearings with d ≤ 152.4 mm, clearance is usually larger than CN. In general, bearings with a clearance larger than CN are used. g means that the average interference is about 0.0005 d.
		76.200	3.0000	304.800	12.0000	+25	0	+64	+38	
		304.800	12.0000	609.600	24.0000	+51	0	+127	+76	
	609.600	24.0000	914.400	36.0000	+76	0	+190	+114		
	Heavy Loads Shock Loads High Speeds	-		76.200	3.0000	+13	0	+64	+38	
		76.200	3.0000	304.800	12.0000	+25	0	g		
304.800		12.0000	609.600	24.0000	+51	0	g			
609.600	24.0000	914.400	36.0000	+76	0	+381	+305			
Rotating Outer Ring Loads	Normal Loads without Shocks	-		76.200	3.0000	+13	0	+13	0	The inner ring cannot be displaced axially. When heavy or shock loads exist, the figures in the above (Rotating inner ring loads, heavy or shock loads) apply.
		76.200	3.0000	304.800	12.0000	+25	0	+25	0	
		304.800	12.0000	609.600	24.0000	+51	0	+51	0	
	609.600	24.0000	914.400	36.0000	+76	0	+76	0		
	-	-		76.200	3.0000	+13	0	0	-13	The inner ring can be displaced axially.
		76.200	3.0000	304.800	12.0000	+25	0	0	-25	
304.800		12.0000	609.600	24.0000	+51	0	0	-51		
609.600	24.0000	914.400	36.0000	+76	0	0	-76			

(2) Bearings of Precision Classes 3 and 0 (1)

Units : μm

Operating Conditions		Nominal Bore Diameters d				Bore Diameter Tolerances & ds		Shaft Diameter Tolerances		Remarks
		over		incl.		high	low	high	low	
		(mm)	1/25.4	(mm)	1/25.4					
Rotating Inner Ring Loads	Precision Machine-Tool Main Spindles	-		76.200	3.0000	+13	0	+30	+18	-
		76.200	3.0000	304.800	12.0000	+13	0	+30	+18	
		304.800	12.0000	609.600	24.0000	+25	0	+64	+38	
	609.600	24.0000	914.400	36.0000	+38	0	+102	+64		
	Heavy Loads Shock Loads High Speeds	-		76.200	3.0000	+13	0	-	-	
		76.200	3.0000	304.800	12.0000	+13	0	-	-	
304.800		12.0000	609.600	24.0000	+25	0	-	-		
609.600	24.0000	914.400	36.0000	+38	0	-	-			
Rotating Outer Ring Loads	Precision Machine-Tool Main Spindles	-		76.200	3.0000	+13	0	+30	+18	-
		76.200	3.0000	304.800	12.0000	+13	0	+30	+18	
		304.800	12.0000	609.600	24.0000	+25	0	+64	+38	
	609.600	24.0000	914.400	36.0000	+38	0	+102	+64		

Note (1) For bearings with d greater than 304.8 mm, Class 0 does not exist.

Table 8.8 Fits of Inch Design Tapered Roller Bearings with Housings

(1) Bearings of Precision Classes 4 and 2

Units : μm

Operating Conditions		Nominal Outside Diameters D				Outside Diameter Tolerances & D_s		Housing Bore Diameter Tolerances		Remarks	
		over (mm)		incl. (mm)		high	low	high	low		
Rotating Inner Ring Loads	Used either on free-end or fixed-end	-		76.200	3.0000	+25	0	+76	+51	The outer ring can be easily displaced axially.	
		76.200	3.0000	127.000	5.0000	+25	0	+76	+51		
		127.000	5.0000	304.800	12.0000	+25	0	+76	+51		
		304.800	12.0000	609.600	24.0000	+51	0	+152	+102		
			609.600	24.0000	914.400	36.0000	+76	0	+229	+152	
	The outer ring position can be adjusted axially.	-		76.200	3.0000	+25	0	+25	0	The outer ring can be displaced axially.	
		76.200	3.0000	127.000	5.0000	+25	0	+25	0		
		127.000	5.0000	304.800	12.0000	+25	0	+51	0		
		304.800	12.0000	609.600	24.0000	+51	0	+76	+25		
			609.600	24.0000	914.400	36.0000	+76	0	+127	+51	
	The outer ring position cannot be adjusted axially.	-		76.200	3.0000	+25	0	-13	-38	Generally, the outer ring is fixed axially.	
		76.200	3.0000	127.000	5.0000	+25	0	-25	-51		
127.000		5.0000	304.800	12.0000	+25	0	-25	-51			
304.800		12.0000	609.600	24.0000	+51	0	-25	-76			
		609.600	24.0000	914.400	36.0000	+76	0	-25	-102		
Rotating Outer Ring Loads	Normal Loads The outer ring position cannot be adjusted axially.	-		76.200	3.0000	+25	0	-13	-38	The outer ring is fixed axially.	
		76.200	3.0000	127.000	5.0000	+25	0	-25	-51		
		127.000	5.0000	304.800	12.0000	+25	0	-25	-51		
		304.800	12.0000	609.600	24.0000	+51	0	-25	-76		
		609.600	24.0000	914.400	36.0000	+76	0	-25	-102		

8

(2) Bearings of Precision Classes 3 and 0 (1)

Units : μm

Operating Conditions		Nominal Outside Diameters D				Outside Diameter Tolerances & D_s		Housing Bore Diameter Tolerances		Remarks
		over (mm)		incl. (mm)		high	low	high	low	
Rotating Inner Ring Loads	Used on free- end	-		152.400	6.0000	+13	0	+38	+25	The outer ring can be easily displaced axially.
		152.400	6.0000	304.800	12.0000	+13	0	+38	+25	
		304.800	12.0000	609.600	24.0000	+25	0	+64	+38	
		609.600	24.0000	914.400	36.0000	+38	0	+89	+51	
	Used on fixed- end	-		152.400	6.0000	+13	0	+25	+13	The outer ring can be displaced axially.
		152.400	6.0000	304.800	12.0000	+13	0	+25	+13	
		304.800	12.0000	609.600	24.0000	+25	0	+51	+25	
		609.600	24.0000	914.400	36.0000	+38	0	+76	+38	
	The outer ring position can be adjusted axially.	-		152.400	6.0000	+13	0	+13	0	Generally, the outer ring is fixed axially.
		152.400	6.0000	304.800	12.0000	+13	0	+25	0	
		304.800	12.0000	609.600	24.0000	+25	0	+25	0	
		609.600	24.0000	914.400	36.0000	+38	0	+38	0	
The outer ring position cannot be adjusted axially.	-		152.400	6.0000	+13	0	0	-13	The outer ring is fixed axially.	
	152.400	6.0000	304.800	12.0000	+13	0	0	-25		
	304.800	12.0000	609.600	24.0000	+25	0	0	-25		
	609.600	24.0000	914.400	36.0000	+38	0	0	-38		
Rotating Outer Ring Loads	Normal Loads The outer ring position cannot be adjusted axially.	-		76.200	3.0000	+13	0	-13	-25	The outer ring is fixed axially.
		76.200	3.0000	152.400	6.0000	+13	0	-13	-25	
		152.400	6.0000	304.800	12.0000	+13	0	-13	-38	
		304.800	12.0000	609.600	24.0000	+25	0	-13	-38	
		609.600	24.0000	914.400	36.0000	+38	0	-13	-51	

Note (1) For bearings with D greater than 304.8 mm, Class 0 does not exist.

Fits and Internal Clearances

8.2 Bearing Internal Clearance

8.2.1 Internal Clearance and Their Standards

The internal clearance in rolling bearings in operation greatly influences bearing performance including fatigue life, vibration, noise, heat-generation, etc. Consequently, the selection of the proper internal clearance is one of the most important tasks when choosing a bearing after the type and size have been determined.

This bearing internal clearance is the combined clearance between the inner/outer rings and rolling elements. The radial and axial clearance are defined as the total amount that one ring can be displaced relative to the other in the radial and axial directions respectively (Fig. 8.1).

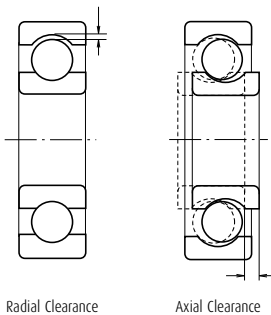

Fig. 8.7 Bearing Internal Clearance

To obtain accurate measurements, the clearance is generally measured by applying a specified measuring load on the bearing; therefore, the measured clearance (sometimes called "measured clearance" to make a distinction) is always slightly larger than the theoretical internal clearance (called "geometrical clearance" for radial bearings) by the amount of elastic deformation caused by the measuring load.

Therefore, the theoretical internal clearance may be obtained by correcting the measured clearance by the amount of elastic deformation. However, in the case of roller bearings this elastic deformation is negligibly small.

Usually the clearance before mounting is the one specified as the theoretical internal clearance.

In Table 8.9, reference table and page numbers are listed by bearing types.

Table 8.9 Index for Radial Internal Clearance by Bearing Types

Bearing Types		Table Number	Page Number
Deep Groove Ball Bearings		8.10	A169
Extra Small and Miniature Ball Bearings		8.11	A169
Magneto Bearings		8.12	A169
Self-Aligning Ball Bearings		8.13	A170
Deep Groove Ball Bearings	For Motors	8.14.1	A170
Cylindrical Roller Bearings		8.14.2	A170
Cylindrical Roller Bearings	With Cylindrical Bores With Cylindrical Bores (Matched) With Tapered Bores (Matched)	8.15	A171
Spherical Roller Bearings	With Cylindrical Bores With Tapered Bores	8.16	A172
Double-Row and Combined Tapered Roller Bearings		8.17	A173
Combined Angular Contact Ball Bearings (1)		8.18	A174
Four-Point Contact Ball Bearings (1)		8.19	A174

Note (1) Values given are axial clearance.

Table 8.10 Radial Internal Clearance in Deep Groove Ball Bearings

Units : μm

Nominal Bore Diameter d (mm)		Clearance									
		C2		CN		C3		C4		C5	
over	incl.	min.	max.	min.	max.	min.	max.	min.	max.	min.	max.
10	only	0	7	2	13	8	23	14	29	20	37
10	18	0	9	3	18	11	25	18	33	25	45
18	24	0	10	5	20	13	28	20	36	28	48
24	30	1	11	5	20	13	28	23	41	30	53
30	40	1	11	6	20	15	33	28	46	40	64
40	50	1	11	6	23	18	36	30	51	45	73
50	65	1	15	8	28	23	43	38	61	55	90
65	80	1	15	10	30	25	51	46	71	65	105
80	100	1	18	12	36	30	58	53	84	75	120
100	120	2	20	15	41	36	66	61	97	90	140
120	140	2	23	18	48	41	81	71	114	105	160
140	160	2	23	18	53	46	91	81	130	120	180
160	180	2	25	20	61	53	102	91	147	135	200
180	200	2	30	25	71	63	117	107	163	150	230
200	225	2	35	25	85	75	140	125	195	175	265
225	250	2	40	30	95	85	160	145	225	205	300
250	280	2	45	35	105	90	170	155	245	225	340
280	315	2	55	40	115	100	190	175	270	245	370
315	355	3	60	45	125	110	210	195	300	275	410
355	400	3	70	55	145	130	240	225	340	315	460
400	450	3	80	60	170	150	270	250	380	350	510
450	500	3	90	70	190	170	300	280	420	390	570
500	560	10	100	80	210	190	330	310	470	440	630
560	630	10	110	90	230	210	360	340	520	490	690
630	710	20	130	110	260	240	400	380	570	540	760
710	800	20	140	120	290	270	450	430	630	600	840

Remarks To obtain the measured values, use the clearance correction for radial clearance increase caused by the measuring load in the table below.

For the C2 clearance class, the smaller value should be used for bearings with minimum clearance and the larger value for bearings near the maximum clearance range.

Units : μm

Nominal Bore Diameter d (mm)		Measuring Load		Radial Clearance Correction Amount				
				C2	CN	C3	C4	C5
over	incl.	(N)	{kgf}					
10 (incl)	18	24.5	{2.5}	3 to 4	4	4	4	4
18	50	49	{5}	4 to 5	5	6	6	6
50	280	147	{15}	6 to 8	8	9	9	9

Remarks For values exceeding 280 mm, please contact NSK.

Table 8.11 Radial Internal Clearance in Extra Small and Miniature Ball Bearings

Units : μm

Clearance Symbol	MC1	MC2	MC3	MC4	MC5	MC6
Clearance	min. max.	min. max.	min. max.	min. max.	min. max.	min. max.
	0 5	3 8	5 10	8 13	13 20	20 28

- Remarks**
- The standard clearance is MC3.
 - To obtain the measured value, add correction amount in the table below.

Units : μm

Clearance Symbol	MC1	MC2	MC3	MC4	MC5	MC6
Clearance Correction Value	1	1	1	1	2	2

The measuring loads are as follows:

For miniature ball bearings*

2.5 N {0.25 kgf}

For extra small ball bearings*

4.4 N {0.45 kgf}

* For their classification, refer to Table 1 on Page B054

Table 8.12 Radial Internal Clearance in Magneto Bearings

Units : μm

Nominal Bore Diameter d (mm)		Bearing Series	Clearance	
			min.	max.
over	incl.			
2.5	30	EN	10	50
		E	30	60

Fits and Internal Clearances

Table 8.13 Radial Internal Clearance in Self-Aligning Ball Bearings

Units : μm

Nominal Bore Diameter d (mm)		Clearance in Bearings with Cylindrical Bores										Clearance in Bearings with Tapered Bores									
		C2		CN		C3		C4		C5		C2		CN		C3		C4		C5	
over	incl.	min.	max.	min.	max.	min.	max.	min.	max.	min.	max.	min.	max.	min.	max.	min.	max.	min.	max.	min.	max.
2.5	6	1	8	5	15	10	20	15	25	21	33	-	-	-	-	-	-	-	-	-	-
6	10	2	9	6	17	12	25	19	33	27	42	-	-	-	-	-	-	-	-	-	-
10	14	2	10	6	19	13	26	21	35	30	48	-	-	-	-	-	-	-	-	-	-
14	18	3	12	8	21	15	28	23	37	32	50	-	-	-	-	-	-	-	-	-	-
18	24	4	14	10	23	17	30	25	39	34	52	7	17	13	26	20	33	28	42	37	55
24	30	5	16	11	24	19	35	29	46	40	58	9	20	15	28	23	39	33	50	44	62
30	40	6	18	13	29	23	40	34	53	46	66	12	24	19	35	29	46	40	59	52	72
40	50	6	19	14	31	25	44	37	57	50	71	14	27	22	39	33	52	45	65	58	79
50	65	7	21	16	36	30	50	45	69	62	88	18	32	27	47	41	61	56	80	73	99
65	80	8	24	18	40	35	60	54	83	76	108	23	39	35	57	50	75	69	98	91	123
80	100	9	27	22	48	42	70	64	96	89	124	29	47	42	68	62	90	84	116	109	144
100	120	10	31	25	56	50	83	75	114	105	145	35	56	50	81	75	108	100	139	130	170
120	140	10	38	30	68	60	100	90	135	125	175	40	68	60	98	90	130	120	165	155	205
140	160	15	44	35	80	70	120	110	161	150	210	45	74	65	110	100	150	140	191	180	240

Table 8.14 Radial Internal Clearance in Bearings for Electric Motors
Table 8.14.1 Deep Groove Ball Bearings for Electric Motors

Units : μm

Nominal Bore Diameter d (mm)		Clearance		Remarks	
		CM		Recommended Fit	
over	incl.	min.	max.	Shaft	Housing Bore
10 (incl.)	18	4	11	js5 (j5)	H6, H7 ⁽¹⁾ or J56, J57 (J6, J7) ⁽²⁾
18	30	5	12	k5	
30	50	9	17		
50	80	12	22		
80	100	18	30	m5	
100	120	18	30		
120	160	24	38		

- Notes** (1) Applicable to outer rings that require movement in the axial direction.
(2) Applicable to outer rings that do not require movement in the axial direction.

Remarks The radial clearance increase caused by the measuring load is equal to the correction amount for CN clearance in the remarks under Table 8.10.

Table 8.14.2 Cylindrical Roller Bearings for Electric Motors

Units : μm

Nominal Bore Diameter d (mm)		Clearance				Remarks	
		Interchangeable CT		Non-Interchangeable CM		Recommended Fit	
over	incl.	min.	max.	min.	max.	Shaft	Housing Bore
24	40	15	35	15	30	k5	J56, J57 (J6, J7) ⁽¹⁾ or K6, K7 ⁽²⁾
40	50	20	40	20	35	m5	
50	65	25	45	25	40		
65	80	30	50	30	45		
80	100	35	60	35	55	n6	
100	120	35	65	35	60		
120	140	40	70	40	65		
140	160	50	85	50	80		
160	180	60	95	60	90		
180	200	65	105	65	100		

- Notes** (1) Applicable to outer rings that require movement in the axial direction.
(2) Applicable to outer rings that do not require movement in the axial direction.

Table 8.15 Radial Internal Clearance in Cylindrical Roller Bearings and Solid-Type Needle Roller Bearings

Units : μm

Nominal Bore Diameter d (mm)	Clearance in Bearings with Cylindrical Bores								Clearance in Non-Interchangeable Bearings with Cylindrical Bores													
	C2		CN		C3		C4		C5		CC1		CC2		CC (1)		CC3		CC4		CC5	
over incl.	min.	max.	min.	max.	min.	max.	min.	max.	min.	max.	min.	max.	min.	max.	min.	max.	min.	max.	min.	max.	min.	max.
- 10	0	25	20	45	35	60	50	75	-	-	-	-	-	-	-	-	-	-	-	-	-	-
10 24	0	25	20	45	35	60	50	75	65	90	5	15	10	20	20	30	35	45	45	55	65	75
24 30	0	25	20	45	35	60	50	75	70	95	5	15	10	25	25	35	40	50	50	60	70	80
30 40	5	30	25	50	45	70	60	85	80	105	5	15	12	25	25	40	45	55	55	70	80	95
40 50	5	35	30	60	50	80	70	100	95	125	5	18	15	30	30	45	50	65	65	80	95	110
50 65	10	40	40	70	60	90	80	110	110	140	5	20	15	35	35	50	55	75	75	90	110	130
65 80	10	45	40	75	65	100	90	125	130	165	10	25	20	40	40	60	70	90	90	110	130	150
80 100	15	50	50	85	75	110	105	140	155	190	10	30	25	45	45	70	80	105	105	125	155	180
100 120	15	55	50	90	85	125	125	165	180	220	10	30	25	50	50	80	95	120	120	145	180	205
120 140	15	60	60	105	100	145	145	190	200	245	10	35	30	60	60	90	105	135	135	160	200	230
140 160	20	70	70	120	115	165	165	215	225	275	10	35	35	65	65	100	115	150	150	180	225	260
160 180	25	75	75	125	120	170	170	220	250	300	10	40	35	75	75	110	125	165	165	200	250	285
180 200	35	90	90	145	140	195	195	250	275	330	15	45	40	80	80	120	140	180	180	220	275	315
200 225	45	105	105	165	160	220	220	280	305	365	15	50	45	90	90	135	155	200	200	240	305	350
225 250	45	110	110	175	170	235	235	300	330	395	15	50	50	100	100	150	170	215	215	265	330	380
250 280	55	125	125	195	190	260	260	330	370	440	20	55	55	110	110	165	185	240	240	295	370	420
280 315	55	130	130	205	200	275	275	350	410	485	20	60	60	120	120	180	205	265	265	325	410	470
315 355	65	145	145	225	225	305	305	385	455	535	20	65	65	135	135	200	225	295	295	360	455	520
355 400	100	190	190	280	280	370	370	460	510	600	25	75	75	150	150	225	255	330	330	405	510	585
400 450	110	210	210	310	310	410	410	510	565	665	25	85	85	170	170	255	285	370	370	455	565	650
450 500	110	220	220	330	330	440	440	550	625	735	25	95	95	190	190	285	315	410	410	505	625	720

Note (1) CC denotes normal clearance for non-interchangeable cylindrical roller bearings and solid-type needle roller bearings.

Units : μm

Nominal Bore Diameter d (mm)	Clearance in Non-Interchangeable Bearings with Tapered Bores															
	CC9 (1)		CC0		CC1		CC2		CC (2)		CC3		CC4		CC5	
over incl.	min.	max.	min.	max.	min.	max.	min.	max.	min.	max.	min.	max.	min.	max.	min.	max.
10 24	5	10	-	-	10	20	20	30	35	45	45	55	55	65	75	85
24 30	5	10	8	15	10	25	25	35	40	50	50	60	60	70	80	95
30 40	5	12	8	15	12	25	25	40	45	55	55	70	70	80	95	110
40 50	5	15	10	20	15	30	30	45	50	65	65	80	80	95	110	125
50 65	5	15	10	20	15	35	35	50	55	75	75	90	90	110	130	150
65 80	10	20	15	30	20	40	40	60	70	90	90	110	110	130	150	170
80 100	10	25	20	35	25	45	45	70	80	105	105	125	125	150	180	205
100 120	10	25	20	35	25	50	50	80	95	120	120	145	145	170	205	230
120 140	15	30	25	40	30	60	60	90	105	135	135	160	160	190	230	260
140 160	15	35	30	50	35	65	65	100	115	150	150	180	180	215	260	295
160 180	15	35	30	50	35	75	75	110	125	165	165	200	200	240	285	320
180 200	20	40	30	50	40	80	80	120	140	180	180	220	220	260	315	355
200 225	20	45	35	60	45	90	90	135	155	200	200	240	240	285	350	395
225 250	25	50	40	65	50	100	100	150	170	215	215	265	265	315	380	430
250 280	25	55	40	70	55	110	110	165	185	240	240	295	295	350	420	475
280 315	30	60	-	-	60	120	120	180	205	265	265	325	325	385	470	530
315 355	30	65	-	-	65	135	135	200	225	295	295	360	360	430	520	585
355 400	35	75	-	-	75	150	150	225	255	330	330	405	405	480	585	660
400 450	40	85	-	-	85	170	170	255	285	370	370	455	455	540	650	735
450 500	45	95	-	-	95	190	190	285	315	410	410	505	505	600	720	815

Notes (1) Clearance CC9 is applicable to cylindrical roller bearings with tapered bores in ISO Tolerance Classes 5 and 4.

(2) CC denotes normal clearance for non-interchangeable cylindrical roller bearings and solid-type needle roller bearings.

Fits and Internal Clearances

**Table 8.16 Radial Internal Clearance
in Spherical Roller Bearings**

Units : μm

Nominal Bore Diameter d (mm)		Clearance in Bearings with Cylindrical Bores										Clearance in Bearings with Tapered Bores									
		C2		CN		C3		C4		C5		C2		CN		C3		C4		C5	
over	incl.	min.	max.	min.	max.	min.	max.	min.	max.	min.	max.	min.	max.	min.	max.	min.	max.	min.	max.	min.	max.
24	30	15	25	25	40	40	55	55	75	75	95	20	30	30	40	40	55	55	75	75	95
30	40	15	30	30	45	45	60	60	80	80	100	25	35	35	50	50	65	65	85	85	105
40	50	20	35	35	55	55	75	75	100	100	125	30	45	45	60	60	80	80	100	100	130
50	65	20	40	40	65	65	90	90	120	120	150	40	55	55	75	75	95	95	120	120	160
65	80	30	50	50	80	80	110	110	145	145	180	50	70	70	95	95	120	120	150	150	200
80	100	35	60	60	100	100	135	135	180	180	225	55	80	80	110	110	140	140	180	180	230
100	120	40	75	75	120	120	160	160	210	210	265	65	100	100	135	135	170	170	220	220	280
120	140	50	95	95	145	145	190	190	240	240	300	80	120	120	160	160	200	200	260	260	330
140	160	60	110	110	170	170	220	220	280	280	350	90	130	130	180	180	230	230	300	300	380
160	180	65	120	120	180	180	240	240	310	310	390	100	140	140	200	200	260	260	340	340	430
180	200	70	130	130	200	200	260	260	340	340	430	110	160	160	220	220	290	290	370	370	470
200	225	80	140	140	220	220	290	290	380	380	470	120	180	180	250	250	320	320	410	410	520
225	250	90	150	150	240	240	320	320	420	420	520	140	200	200	270	270	350	350	450	450	570
250	280	100	170	170	260	260	350	350	460	460	570	150	220	220	300	300	390	390	490	490	620
280	315	110	190	190	280	280	370	370	500	500	630	170	240	240	330	330	430	430	540	540	680
315	355	120	200	200	310	310	410	410	550	550	690	190	270	270	360	360	470	470	590	590	740
355	400	130	220	220	340	340	450	450	600	600	750	210	300	300	400	400	520	520	650	650	820
400	450	140	240	240	370	370	500	500	660	660	820	230	330	330	440	440	570	570	720	720	910
450	500	140	260	260	410	410	550	550	720	720	900	260	370	370	490	490	630	630	790	790	1 000
500	560	150	280	280	440	440	600	600	780	780	1 000	290	410	410	540	540	680	680	870	870	1 100
560	630	170	310	310	480	480	650	650	850	850	1 100	320	460	460	600	600	760	760	980	980	1 230
630	710	190	350	350	530	530	700	700	920	920	1 190	350	510	510	670	670	850	850	1 090	1 090	1 360
710	800	210	390	390	580	580	770	770	1 010	1 010	1 300	390	570	570	750	750	960	960	1 220	1 220	1 500
800	900	230	430	430	650	650	860	860	1 120	1 120	1 440	440	640	640	840	840	1 070	1 070	1 370	1 370	1 690
900	1 000	260	480	480	710	710	930	930	1 220	1 220	1 570	490	710	710	930	930	1 190	1 190	1 520	1 520	1 860
1 000	1 120	290	530	530	780	780	1 020	1 020	1 330	-	-	530	770	770	1 030	1 030	1 300	1 300	1 670	-	-
1 120	1 250	320	580	580	860	860	1 120	1 120	1 460	-	-	570	830	830	1 120	1 120	1 420	1 420	1 830	-	-
1 250	1 400	350	640	640	950	950	1 240	1 240	1 620	-	-	620	910	910	1 230	1 230	1 560	1 560	2 000	-	-

**Table 8.17 Radial Internal Clearance
in Double-Row and Combined Tapered Roller Bearings**

Units : μm

Cylindrical Bore Tapered Bore Nominal Bore Diameterd (mm)		Clearance											
		C1		C2		CN		C3		C4		C5	
		-		C1		C2		CN		C3		C4	
over	incl.	min.	max.	min.	max.	min.	max.	min.	max.	min.	max.	min.	max.
-	18	0	10	10	20	20	30	35	45	50	60	65	75
18	24	0	10	10	20	20	30	35	45	50	60	65	75
24	30	0	10	10	20	20	30	40	50	50	60	70	80
30	40	0	12	12	25	25	40	45	60	60	75	80	95
40	50	0	15	15	30	30	45	50	65	65	80	95	110
50	65	0	15	15	35	35	55	60	80	80	100	110	130
65	80	0	20	20	40	40	60	70	90	90	110	130	150
80	100	0	25	25	50	50	75	80	105	105	130	155	180
100	120	5	30	30	55	55	80	90	115	120	145	180	210
120	140	5	35	35	65	65	95	100	130	135	165	200	230
140	160	10	40	40	70	70	100	110	140	150	180	220	260
160	180	10	45	45	80	80	115	125	160	165	200	250	290
180	200	10	50	50	90	90	130	140	180	180	220	280	320
200	225	20	60	60	100	100	140	150	190	200	240	300	340
225	250	20	65	65	110	110	155	165	210	220	270	330	380
250	280	20	70	70	120	120	170	180	230	240	290	370	420
280	315	30	80	80	130	130	180	190	240	260	310	410	460
315	355	30	80	80	130	140	190	210	260	290	350	450	510
355	400	40	90	90	140	150	200	220	280	330	390	510	570
400	450	45	95	95	145	170	220	250	310	370	430	560	620
450	500	50	100	100	150	190	240	280	340	410	470	620	680
500	560	60	110	110	160	210	260	310	380	450	520	700	770
560	630	70	120	120	170	230	290	350	420	500	570	780	850
630	710	80	130	130	180	260	310	390	470	560	640	870	950
710	800	90	140	150	200	290	340	430	510	630	710	980	1 060
800	900	100	150	160	210	320	370	480	570	700	790	1 100	1 200
900	1 000	120	170	180	230	360	410	540	630	780	870	1 200	1 300
1 000	1 120	130	190	200	260	400	460	600	700	-	-	-	-
1 120	1 250	150	210	220	280	450	510	670	770	-	-	-	-
1 250	1 400	170	240	250	320	500	570	750	870	-	-	-	-

Remarks Axial internal clearance $\&_a = \&_r \cot \alpha H \frac{1.5}{e} \&_r$

where $\&_r$: Radial internal clearance
 α : Contact angle
 e : Constant (Listed in bearing tables)

Fits and Internal Clearances

Table 8.18 Axial Internal Clearance in Combined Angular Contact Ball Bearings (Measured Clearance)

Units : μm

Nominal Bore Diameter d (mm)		Axial Internal Clearance											
		Contact Angle 30°						Contact Angle 40°					
		CN		C3		C4		CN		C3		C4	
over	incl.	min.	max.	min.	max.	min.	max.	min.	max.	min.	max.	min.	max.
-	10	9	29	29	49	49	69	6	26	26	46	46	66
10	18	10	30	30	50	50	70	7	27	27	47	47	67
18	24	19	39	39	59	59	79	13	33	33	53	53	73
24	30	20	40	40	60	60	80	14	34	34	54	54	74
30	40	26	46	46	66	66	86	19	39	39	59	59	79
40	50	29	49	49	69	69	89	21	41	41	61	61	81
50	65	35	60	60	85	85	110	25	50	50	75	75	100
65	80	38	63	63	88	88	115	27	52	52	77	77	100
80	100	49	74	74	99	99	125	35	60	60	85	85	110
100	120	72	97	97	120	120	145	52	77	77	100	100	125
120	140	85	115	115	145	145	175	63	93	93	125	125	155
140	160	90	120	120	150	150	180	66	96	96	125	125	155
160	180	95	125	125	155	155	185	68	98	98	130	130	160
180	200	110	140	140	170	170	200	80	110	110	140	140	170

Remarks This table is applicable to bearings in Tolerance Classes Normal and 6. For internal axial clearance in bearings in tolerance classes better than 5 and contact angles of 15° and 25°, it is advisable to consult NSK.

Table 8.19 Axial Internal Clearance in Four-Point Contact Ball Bearings (Measured Clearance)

Units : μm

Nominal Bore Diameter d (mm)		Axial Internal Clearance					
		CN		C3		C4	
over	incl.	min.	max.	min.	max.	min.	max.
10	18	45	85	75	125	115	165
18	40	56	106	96	146	136	186
40	60	76	126	116	166	156	206
60	80	86	136	126	176	166	226
80	100	96	156	136	196	186	246
100	140	116	176	156	216	206	266
140	180	136	196	176	246	226	296
180	220	156	226	206	276	256	326
220	260	175	245	225	305	285	365
260	300	195	275	255	335	315	395
300	350	215	305	275	365	345	425
350	400	245	335	315	405	385	475
400	500	285	385	355	455	435	525

8.2.2 Selection of Bearing Internal Clearance

Among the bearing internal clearance listed in the tables, the CN Clearance is adequate for standard operating conditions. The clearance becomes progressively smaller from C2 to C1 and larger from C3 to C5.

Standard operating conditions are defined as those where the inner ring speed is less than approximately 50% of the limiting speed listed in the bearing tables, the load is less than normal (PI10.1C₁), and the bearing is tight-fitted on the shaft.

As a measure to reduce bearing noise for electric motors, the radial clearance range is narrower than the normal class and the values are somewhat smaller for deep groove ball bearings and cylindrical roller bearings for electric motors. (Refer to Table 8.14.1 and 8.14.2)

Internal clearance varies with the fit and temperature differences in operation. The changes in radial clearance in a roller bearing are shown in Fig. 8.8.

(1) Decrease in Radial Clearance Caused by Fitting and Residual Clearance

When the inner ring or the outer ring is tight-fitted on a shaft or in a housing, a decrease in the radial internal clearance is caused by the expansion or contraction of the bearing rings. The decrease varies according to the bearing type and size and design of the shaft and housing. The amount of this decrease is approximately 70 to 90% of the interference (refer to Section 8.1.2, Fits (5), Pages A156 and A157). The internal clearance after subtracting this decrease from the theoretical internal clearance $\&_0$ is called the residual clearance, $\&_r$.

(2) Decrease in Radial Internal Clearance Caused by Temperature Differences between Inner and Outer Rings and Effective Clearance

The frictional heat generated during operation is conducted away through the shaft and housing. Since housings generally conduct heat better than shafts, the temperature of the inner ring and the rolling elements is usually higher than that of the outer ring by 5 to 10 °C. If the shaft is heated or the housing is cooled, the difference in temperature between the inner and outer rings is greater. The radial clearance decreases due to the thermal expansion caused by the temperature difference between the inner and outer rings. The amount of this decrease can be calculated using the following equations:

$$\delta_i H \alpha \Delta t D_e \dots\dots\dots (8.8)$$

where δ_i : Decrease in radial clearance due to temperature difference between inner and outer rings (mm)

α : Coefficient of linear expansion of bearing steel 11.5×10^{-6} (1/°C)

Δt : Temperature difference between inner and outer rings (°C)

D_e : Outer ring raceway diameter (mm)

For ball bearings

$$D_e H \frac{1}{5} (4D + d) \dots\dots\dots (8.9)$$

For roller bearings

$$D_e H \frac{1}{4} (3D + d) \dots\dots\dots (8.10)$$

The clearance after subtracting this δ_i from the residual clearance, $\&_f$ is called the effective clearance, $\&$. Theoretically, the longest life of a bearing can be expected when the effective clearance is slightly negative. However, it is difficult to achieve such an ideal condition, and an excessive negative clearance will greatly shorten the bearing life. Therefore, a clearance of zero or a slightly positive amount, instead of a negative one, should be selected. When single-row angular contact ball bearings or tapered roller bearings are used facing each other, there should be a small effective clearance, unless a preload is required. When two cylindrical roller bearings with a rib on one side are used facing each other, it is necessary to provide adequate axial clearance to allow for shaft elongation during operation.

The radial clearance used in some specific applications are given in Table 8.20. Under special operating conditions, it is advisable to consult NSK.

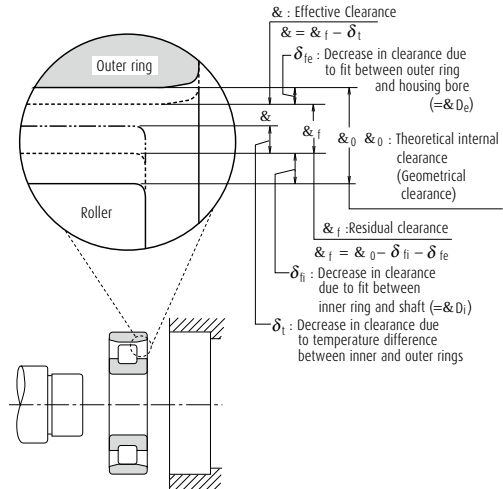

Fig. 8.8 Changes in Radial Internal Clearance of Bearings

Table 8.20 Examples of Clearance for Specific Applications

Operating Conditions	Examples	Internal Clearance
When shaft deflection is large.	Semi-floating rear wheels of automobiles	C5 or equivalent
When steam passes through hollow shafts or roller shafts are heated.	Dryers in paper making machines	C3, C4
	Table rollers for rolling mills	C3
When impact loads and vibration are severe or when both the inner and outer rings are tight-fitted.	Traction motors for railways	C4
	Vibrating screens	C3, C4
	Fluid couplings	C4
	Final reduction gears for tractors	C4
When both the inner and outer rings are loose-fitted	Rolling mill roll necks	C2 or equivalent
When noise and vibration restrictions are severe	Small motors with special specifications	C1, C2, CM
When clearance is adjusted after mounting to prevent shaft deflection, etc.	Main shafts of lathes	CC9, CC1

8.3 Technical Data

8.3.1 Temperature Rise and Dimensional Change

Rolling bearings are extremely precise mechanical elements. Any change in dimensional accuracy due to temperature cannot be ignored. Accordingly, it is specified as a rule that measurement of a bearing must be made at 20°C and that the dimensions to be set forth in the standards must be expressed by values at 20°C.

Dimensional change due to temperature change not only affects the dimensional accuracy, but also causes change in the internal clearance of a bearing during operation.

Dimensional change may cause interference between the inner ring and shaft or between the outer ring and housing bore. It is also possible to achieve shrink fitting with large interference by utilizing dimensional change induced by temperature difference. The dimensional change Δl due to temperature rise can be expressed as in Equation (8.11) below:

$$\Delta l = \Delta T \alpha l \quad (\text{mm}) \dots\dots\dots(8.11)$$

where, Δl : Dimensional change (mm)

ΔT : temperature rise (°C)

α : Coefficient of linear expansion for bearing steel

$\alpha = 12.5 \times 10^{-6}$ (1/°C)

l : Original dimension (mm)

Equation (8.11) may be illustrated as shown in Fig. 8.9. In the following cases, Fig. 8.9 can be utilized to easily obtain an approximate numerical values for dimensional change:

- (1) To correct dimensional measurements according to the ambient air temperature
- (2) To find the change in bearing internal clearance due to temperature difference between inner and outer rings during operation
- (3) To find the relationship between the interference and heating temperature during shrink fitting
- (4) To find the change in the interference when a temperature difference exists on the fit surface

Example

To what temperature should the inner ring be heated if an inner ring of 110 mm in bore is to be shrink fitted to a shaft belonging to the n6 tolerance range class? The maximum interference between the n6 shaft of 110 in diameter and the inner ring is 0.065. To enable insertion of the inner ring with ease on the shaft, there must be a clearance of 0.03 to 0.04. Accordingly, the amount to expand the inner ring must be 0.095 to 0.105. Intersection of a vertical axis $\Delta l = 0.105$ and a horizontal axis $l = 110$ is determined on a diagram. ΔT is located in the temperature range between 70°C and 80°C ($\Delta T = 77^\circ\text{C}$). Therefore, it is enough to set the inner ring heating temperature to the room temperature +80°C.

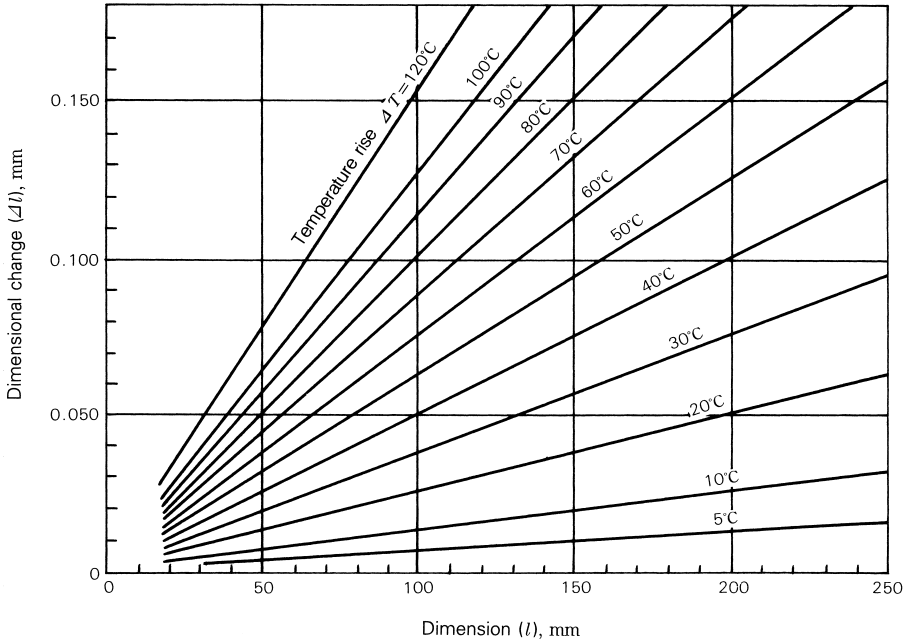

Fig. 8.9 Temperature Rise and Dimensional Change of Bearing Steel

Fits and Internal Clearances

8.3.2 Interference Deviation Due to Temperature Rise (Aluminum Housing, Plastic Housing)

For reducing weight and cost or improving the performance of equipment, bearing housing materials such as aluminum, light alloys, or plastics (polyacetal resin, etc.) are often used. When non-ferrous materials are used in housings, any temperature rise occurring during operation affects the interference or clearance of the outer ring due to the difference in the coefficients of linear expansion. This change is large for plastics which have high coefficients of linear expansion. The deviation ΔD_1 of clearance or interference of a fitting surface of a bearing's outer ring due to temperature rise is expressed by the following equation:

$$\Delta D_1 = (\alpha_1 \cdot \Delta T_1 - \alpha_2 \cdot \Delta T_2) D \text{ (mm)} \dots\dots\dots (8.12)$$

- where ΔD_1 : Change of clearance or interference at fitting surface due to temperature rise
- α_1 : Coefficient of linear expansion of housing (1/°C)
- ΔT_1 : Housing temperature rise near fitting surface (°C)
- α_2 : Coefficient of linear expansion of bearing outer ring
Bearing steel $\alpha_2 = 12.5 \times 10^{-6}$ (1/°C)
- ΔT_2 : Outer ring temperature rise near fitting surface (°C)
- D: Bearing outside diameter (mm)

In general, the housing temperature rise and that of the outer ring are somewhat different, but if we assume they are approximately equal near the fitting surfaces, ($\Delta T_1 = \Delta T_2 = \Delta T$), Equation (8.13) becomes,

$$\Delta D_1 = (\alpha_1 - \alpha_2) \Delta T \cdot D \text{ (mm)} \dots\dots\dots (8.13)$$

where ΔT : Temperature rise of outer ring and housing near fitting surfaces (°C)

In the case of an aluminum housing ($\alpha_1 = 23.7 \times 10^{-6}$), Equation (8.13) can be shown graphically as in Fig. 8.10. Among the various plastics, polyacetal resin is one that is often used for bearing housings. The coefficients of linear expansion of plastics may vary or show directional characteristics. In the case of polyacetal resin, for molded products, it is approximately 9×10^{-5} . Equation (8.13) can be shown as in Fig. 8.11.

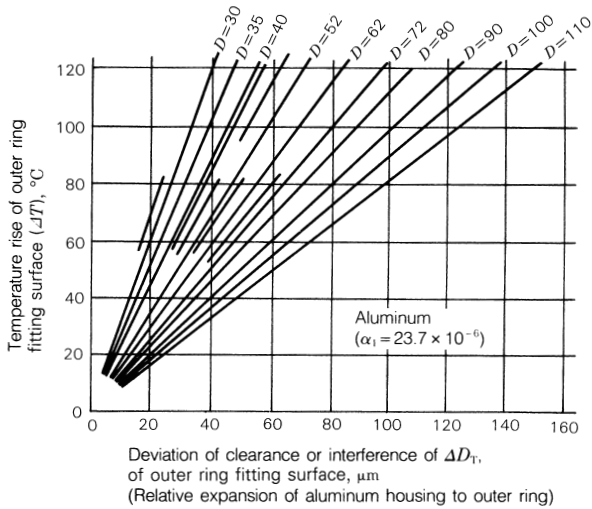

Fig. 8.10 Aluminum Housing

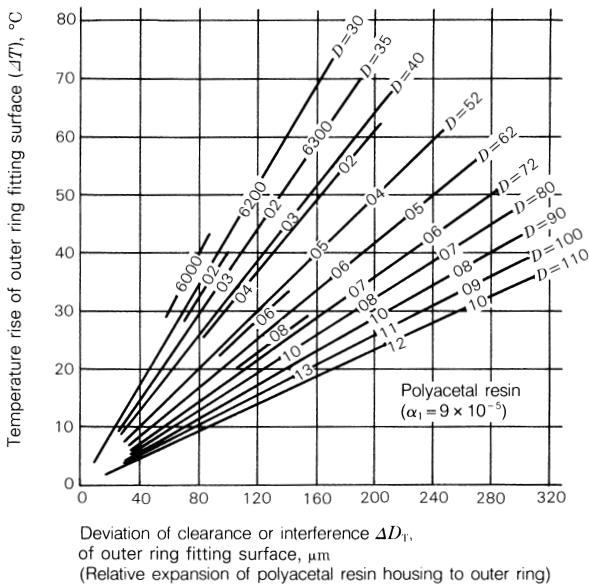

Fig. 8.11 Polyacetal Resin Housing

Fits and Internal Clearances

8.3.3 Calculating Residual Internal Clearance After Mounting

The various types of internal bearing clearance were discussed in Section 8.2.2. This section will explain the step by step procedures for calculating residual internal clearance. When the inner ring of a bearing is press fit onto a shaft, or when the outer ring is press fit into a housing, it stands to reason that radial internal clearance will decrease due to the resulting expansion or contraction of the bearing raceways. Generally, most bearing applications have a rotating shaft which requires a tight fit between the inner ring and shaft and a loose fit between the outer ring and housing. Generally, therefore, only the effect of the interference on the inner ring needs to be taken into account. Below we have selected a 6310 single row deep groove ball bearing for our representative calculations. The shaft is set at k5, with the housing set at H7. An interference fit is applied only to the inner ring. Shaft diameter, bore size and radial clearance are the standard bearing measurements. Assuming that 99.7% of the parts are within tolerance, the mean value (m_{df}) and standard deviation (σ_{df}) of the internal clearance after mounting (residual clearance) can be calculated. Measurements are given in units of millimeters (mm).

$$\sigma_s = \frac{R_s/2}{3} = 0.0018$$

$$\sigma_i = \frac{R_i/2}{3} = 0.0020$$

$$\sigma_{r10} = \frac{R_{r10}/2}{3} = 0.0028$$

$$\sigma_{df}^2 = \sigma_s^2 + \sigma_i^2$$

$$m_{df} = m_{r10} - \lambda_4 (m_s - m_i) = 0.0035$$

$$\sigma_{df} = \sqrt{\sigma_{r10}^2 + \lambda_4^2 \sigma_i^2} = 0.0035$$

- where
- σ_s : Standard deviation of shaft diameter
 - σ_i : Standard deviation of bore diameter
 - σ_f : Standard deviation of interference
 - σ_{r10} : Standard deviation of radial clearance (before mounting)
 - σ_{df} : Standard deviation of residual clearance (after mounting)
 - m_s : Mean value of shaft diameter ($\phi 50 + 0.008$)
 - m_i : Mean value of bore diameter ($\phi 50 - 0.006$)
 - m_{r10} : Mean value of radial clearance (0.014)
 - m_{df} : Mean value of residual clearance (after mounting)
 - R_s : Shaft tolerance (0.011)
 - R_i : Bearing bore tolerance (0.012)
 - R_{r10} : Range in radial clearance (before mounting) (0.017)
 - λ_4 : Rate of raceway expansion from apparent interference (0.75 from Fig. 8.12)

The average amount of raceway expansion and contraction from apparent interference is calculated from $\lambda_4 (m_m - m_i)$. To determine, within a 99.7% probability, the variation in internal clearance after mounting (R_{df}), we use the following equation.

$$R_{df} = m_{df} \pm 3\sigma_{df} = +0.014 \text{ to } -0.007$$

In other words, the mean value of residual clearance (m_{df}) is +0.0035, and the range is from -0.007 to +0.014 for a 6310 bearing.

Units : μm	
Shaft diameter	$\phi 50 \begin{matrix} +0.013 \\ +0.002 \end{matrix}$
Bearing bore diameter, (d)	$\phi 50 \begin{matrix} 0 \\ -0.012 \end{matrix}$
Radial internal clearance (r_{10})	0.006 to 0.023(1)

Note (1)Standard internal clearance, unmounted

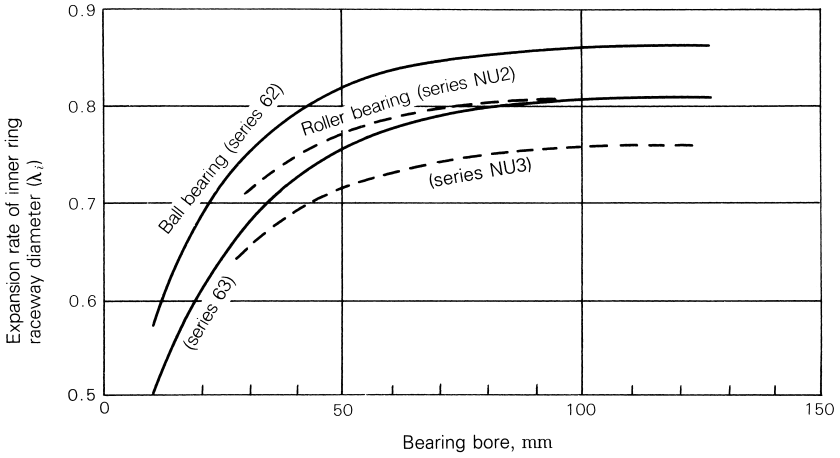

Fig. 8.12 Rate of Inner Ring Raceway Expansion (λ_i) from Apparent Interference

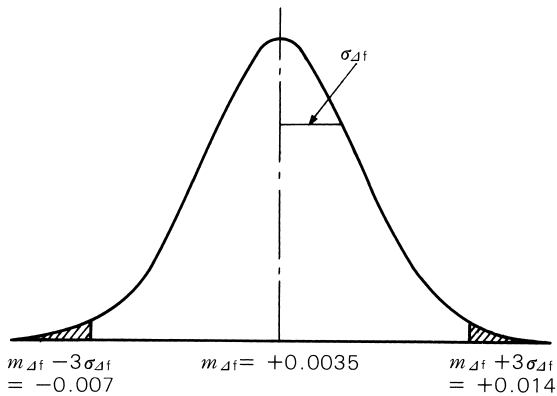

Fig. 8.13 Distribution of Residual Internal Clearance

Fits and Internal Clearances

8.3.4 Effect of Interference Fit on Bearing Raceways (Fit of Inner Ring)

One of the important factors that relates to radial clearance is the reduction in radial clearance resulting from the mounting fit. When inner ring is mounted on a shaft with an interference fit and the outer ring is secured in a housing with an interference fit, the inner ring will expand and the outer ring will contract. The means of calculating the amount of ring expansion or contraction were previously noted in Section 8.1.2 (5), however, the equation for establishing the amount of inner raceway expansion (ΔD_i) is given in Equation (8.14).

$$\Delta D_i = \Delta d k \frac{1 - k_0^2}{1 - k^2 k_0^2} \dots\dots\dots (8.14)$$

- where Δd : Effective interference (mm)
- k: Ratio of bore to inner raceway diameter;
k=d/D_i
- k₀: Ratio of inside to outside diameter of hollow shaft; k₀=d₀/D_i
- d: Bore or shaft diameter (mm)
- D_i: Inner raceway diameter (mm)
- d₀: Inside diameter of hollow shaft (mm)

Equation (8.14) has been translated into a clearer graphical form in Fig. 8.14. The vertical axis of Fig. 8.14 represents the inner raceway diameter expansion in relation to the amount of interference. The horizontal axis is the ratio of inside and outside diameter of the hollow shaft (k₀) and uses as its parameter the ratio of bore diameter and raceway diameter of the inner ring (k). Generally, the decrease in radial clearance is calculated to be approximately 80% of the interference. However, this is for solid shaft mountings only. For hollow shaft mountings the decrease in radial clearance varies with the ratio of inside to outside diameter of the shaft. Since the general 80% rule is based on average bearing bore size to inner raceway diameter ratios, the change will vary with different bearing types, sizes, and series. Typical plots for Single Row Deep Groove Ball Bearings and for Cylindrical Roller Bearings are shown in Figs. 8.15 and 8.16. Values in Fig. 8.14 apply only for steel shafts. Let's take as an example a 6220 ball bearing mounted on a hollow shaft (diameter d=100 mm, inside diameter d₀=65 mm) with a fit class of m5 and determine the decrease in radial clearance. The ratio between bore diameter and raceway diameter, k is 0.87 as shown in Fig. 8.15. The ratio of inside to outside diameter for shaft, k₀, is k₀=d₀ / d=0.65. Thus, reading from Fig. 8.14, the rate of raceway expansion is 73%. Given that an interference of m5 has a mean value of

30 μm, the amount of raceway expansion, or, the amount of decrease in the radial clearance from the fit is
0.73 × 30 = 22 μm.

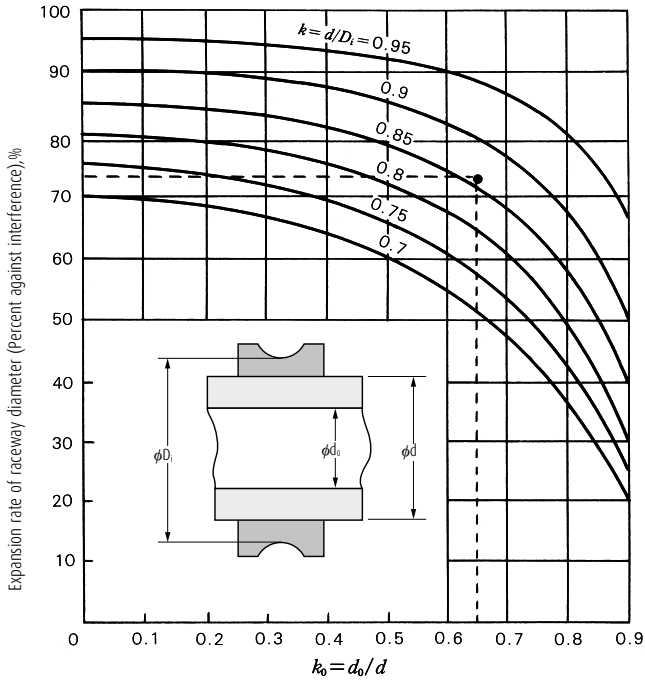

Fig. 8.14 Raceway Expansion in Relation to Bearing Fit (Inner Ring Fit upon Steel Shaft)

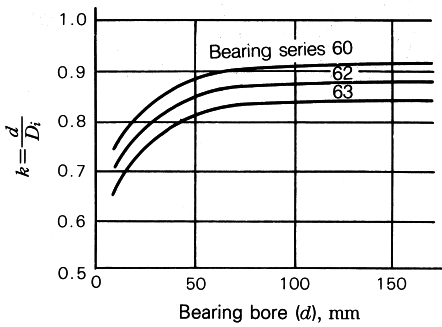

Fig. 8.15 Ratio of Bore Size to Raceway Diameter for Single Row Deep Groove Ball Bearings

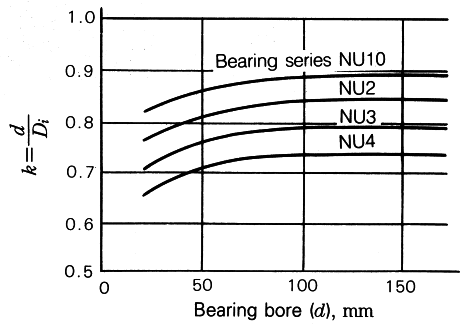

Fig. 8.16 Ratio of Bore Size to Raceway Diameter for Cylindrical Roller Bearings

8.3.5 Effect of Interference Fit on Bearing Raceways (Fit of Outer Ring)

We continue with the calculation of the raceway contraction of the outer ring after fitting. When a bearing load is applied on a rotating inner ring (outer ring carrying a static load), an interference fit is adopted for the inner ring and the outer ring is mounted either with a transition fit or a clearance fit. However, when the bearing load is applied on a rotating outer ring (inner ring carrying a static load) or when there is an indeterminate load and the outer ring must be mounted with an interference fit, a decrease in radial internal clearance caused by the fit begins to contribute in the same way as when the inner ring is mounted with an interference fit. Actually, because the amount of interference that can be applied to the outer ring is limited by stress, and because the constraints of most bearing applications make it difficult to apply a large amount of interference to the outer ring, and instances where there is an indeterminate load are quite rare compared to those where a rotating inner ring carries the load, there are few occasions where it is necessary to be cautious about the decrease in radial clearance caused by outer-ring interference. The decrease in outer raceway diameter ΔD_e is calculated using Equation (8.15).

$$\Delta D_e = \Delta d \cdot h \frac{1 - h_0^2}{1 - h^2 h_0^2} \dots \dots \dots (8.15)$$

- where ΔD : Effective interference (mm)
- h: Ratio between raceway dia. and outside dia. of outer ring, $h = D_e/D$
- h_0 : Housing thickness ratio, $h_0 = D/D_0$
- D: Bearing outside diameter (housing bore diameter) (mm)
- D_e : Raceway diameter of outer ring (mm)
- D_0 : Outside diameter of housing (mm)

Fig. 8.17 represents the above equation in graphic form. The vertical axis show the outer-ring raceway contraction as a percentage of interference, and the horizontal axis is the housing thickness ratio h_0 . The data are plotted for constant values of the outer-ring thickness ratio from 0.7 through 1.0 in increments of 0.05. The value of thickness ratio h will differ with bearing type, size, and diameter series. Representative values for single-row deep groove ball bearings and for cylindrical roller bearings are given in Figs. 8.18 and 8.19 respectively.

Loads applied on rotating outer rings occur in such applications as automotive front axles, tension pulleys, conveyor systems, and other pulley systems. As an example, we estimate the amount of decrease in radial clearance assuming a 6207 ball bearing is mounted in a steel housing with an N7 fit. The outside diameter of the housing is assumed to be $D_0=95$, and the bearing outside diameter is $D=72$. From Fig. 8.18, the outer-ring thickness ratio, h , is 0.9. Because $h_0 = D/D_0 = 0.76$, from Fig. 8.17, the amount of raceway contraction is 71%. Taking the mean value for N7 interference as 18 μm , the amount of contraction of the outer raceway, or the amount of decrease in radial clearance is $0.71 \times 18 = 13 \mu\text{m}$.

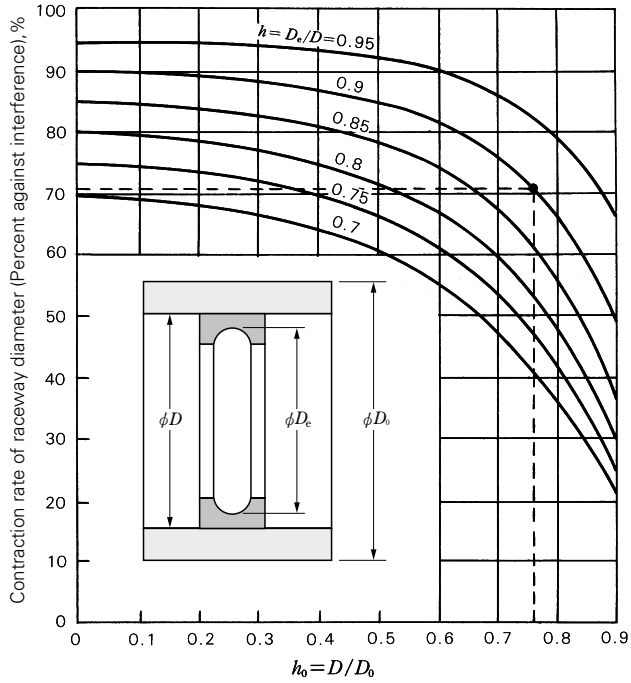

Fig. 8.17 Raceway Contraction in Relation to Bearing Fit (Outer Ring Fit in Steel Housing)

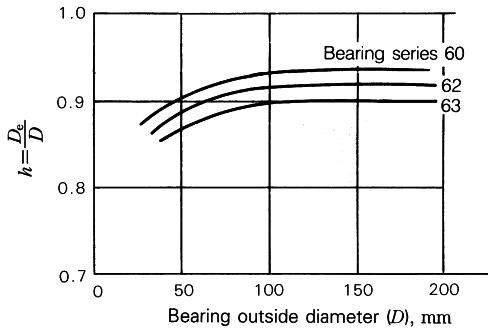

Fig. 8.18 Ratio of Outside Diameter to Raceway Diameter for Single Row Deep Groove Ball Bearings

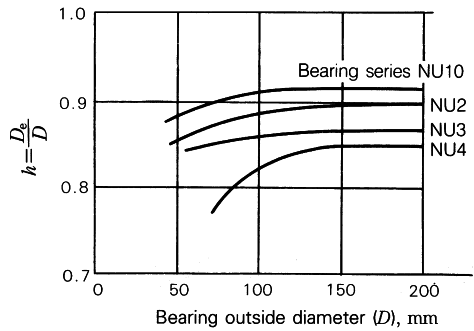

Fig. 8.19 Ratio of Outside Diameter to Raceway Diameter for Cylindrical Roller Bearings

8.3.6 Measuring Method of Internal Clearance of Combined Tapered Roller Bearings (Offset Measuring Method)

Combined tapered roller bearings are available in two types: a back-to-back combination (DB type) and a face-to-face combination (DF type) (see Fig. 8.20 and Fig. 8.21).

The advantages of these combinations can be obtained by assembly as one set or combined with other bearings to be a fixed- or free-side bearing. For the DB type of combined tapered roller bearing, as its cage protrudes from the back side of the outer ring, the outer ring spacer (K spacer in Fig. 8.20) is mounted to prevent mutual contact of cages. For the inner ring, the inner ring spacer (L spacer in Fig. 8.20), having an appropriate width, is provided to secure the clearance. For the DF type, as shown in Fig. 8.21, bearings are used with a K spacer.

In general, to use such a bearing arrangement either an appropriate clearance is required that takes into account the heat generated during operation or an applied preload is required that increases the rigidity of the bearings. The spacer width should be adjusted so as to provide an appropriate clearance or preload (minus clearance) after mounting. Hereunder, we introduce you to a clearance measurement method for a DB arrangement.

(1) As shown in Fig. 8.22, put the bearing A on the surface plate and after stabilization of rollers by rotating the outer ring (more than 10 turns), measure the offset $f_A = T_A - B_A$.

(2) Next, as shown in Fig. 8.23, use the same procedure to measure the other bearing B for its offset $f_B = T_B - B_B$.

(3) Next, measure the width of the K and L spacers as shown in Fig. 8.24.

From the results of the above measurements, the axial clearance Δ_a of the combined tapered roller bearing can be obtained, with the use of symbols shown in Figs. 8.22 through 8.24 by Equation (8.16):

$$\Delta_a = (L - K) - (f_A + f_B) \dots\dots\dots(8.16)$$

As an example, for the combined tapered roller bearing HR32232JDB+KLR10AC3, confirm the clearance of the actual product conforms to the specifications. First, refer to Table 8.17 and notice that the C3 clearance range is $\Delta_r = 110$ to $140 \mu\text{m}$. To compare this specification with the offset measurement results, convert it into an axial clearance Δ_a by using Equation (8.17):

$$\Delta_a = \Delta_r \cot \alpha H \frac{1.5}{e} \dots\dots\dots(8.17)$$

where, e: Constant determined for each bearing No. (Listed in the Bearing Tables of NSK Rolling Bearings Catalog)

referring to the said catalog (Page B223), with use of $e = 0.44$, the following is obtained:

$$\Delta_a = (110 \text{ to } 140) \times \frac{1.5}{e}$$

11380 to 480 μm

It is possible to confirm that the bearing clearance is C3, by verifying that the axial clearance Δ_a of Equation (8.16) (obtained by the bearing offset measurement) is within the above mentioned range.

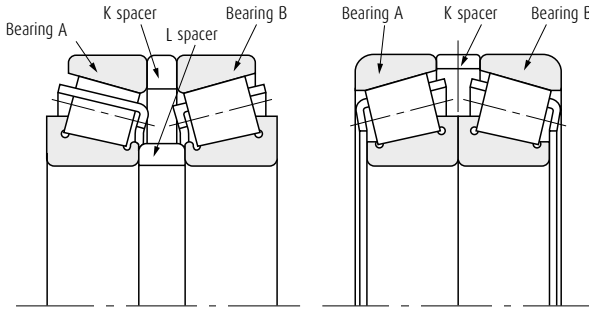

Fig. 8.20 DB Arrangement

Fig. 8.21 DF Arrangement

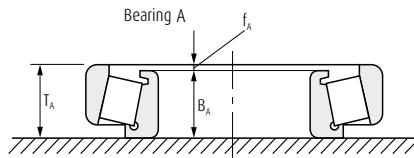

Fig. 8.22

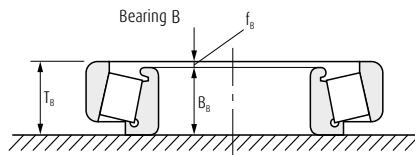

Fig. 8.23

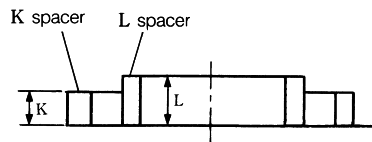

Fig. 8.24

8.3.7 Internal Clearance Adjustment Method when Mounting a Tapered Roller Bearing

The two single row tapered roller bearings are usually arranged in a configuration opposite each other and the clearance is adjusted in the axial direction. There are two types of opposite placement methods: back-to-back arrangement (DB arrangement) and face-to-face arrangement (DF arrangement). The clearance adjustment of the back-to-back arrangement is performed by tightening the inner ring by a shaft nut or a shaft end bolt. In Fig. 8.25, an example using a shaft end bolt is shown. In this case, it is necessary that the fit of the tightening side inner ring with the shaft be a loose fit to allow displacement of the inner ring in the axial direction.

For the face-to-face arrangement, a shim is inserted between the cover, which retains the outer ring in the axial direction, and the housing in order to allow adjustment to the specified axial clearance (Fig. 8.26). In this case, it is necessary to use a loose fit between the tightening side of the outer ring and the housing in order to allow appropriate displacement of the outer ring in the axial direction. When the structure is designed to install the outer ring into the retaining cover (Fig. 8.27), the above measure becomes unnecessary and both mounting and dismounting become easy.

Theoretically when the bearing clearance is slightly negative during operation, the fatigue life becomes the longest, but if the negative clearance becomes much bigger, then the fatigue life becomes very short and heat generation quickly increases. Thus, it is generally arranged that the clearance be slightly positive (a little bigger than zero) while operating. In consideration of the clearance reduction caused by temperature difference of inner and outer rings during operation and difference of thermal expansion of the shaft and housing in the axial direction, the bearing clearance after mounting should be decided. In practice, the clearance C1 or C2 is frequently adopted which is listed in Table 8.17.

In addition, the relationship between the radial clearance Δ_r and axial clearance Δ_a is as follows:

$$\Delta_a = \Delta_r \cot \alpha \frac{1.5}{e}$$

where, α : Contact angle

e : Constant determined for each bearing No.
(Listed in the Bearing Tables of NSK Rolling Bearing Catalog)

Tapered roller bearings, which are used for head spindles of machine tools, automotive final reduction gears, etc., are set to a negative clearance for the purpose of obtaining bearing rigidity. Such a method is called a preload method. There are two different modes of preloading: position preload and constant pressure preload. The position preload is used most often.

For the position preload, there are two methods: one method is to use an already adjusted arrangement of bearings and the other method is to apply the specified preload by tightening an adjustment nut or using an adjustment shim. The constant pressure preload is a method to apply an appropriate preload to the bearing by means of spring or hydraulic pressure, etc. Next we introduce several examples that use these methods:

Fig. 8.28 shows the automotive final reduction gear. For pinion gears, the preload is adjusted by use of an inner ring spacer and shim. For large gears on the other hand, the preload is controlled by tightening the torque of the outer ring retaining screw.

Fig. 8.29 shows the rear wheel of a truck. This is an example of a preload application by tightening the inner ring in the axial direction with a shaft nut. In this case, the preload is controlled by measuring the starting friction moment of the bearing.

Fig. 8.30 shows an example of the head spindle of the lathe, the preload is adjusted by tightening the shaft nut.

Fig. 8.31 shows an example of a constant pressure preload for which the preload is adjusted by the displacement of the spring. In this case, first find a relationship between the spring's preload and displacement, then use this information to establish a constant pressure preload.

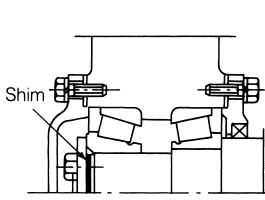

Fig. 8.25 DB Arrangement whose Clearance is Adjusted by Inner Rings.

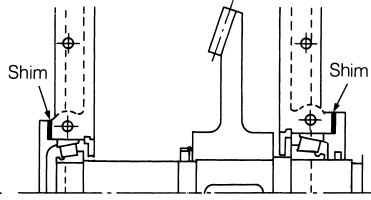

Fig. 8.26 DF Arrangement whose Clearance is Adjusted by Outer Rings.

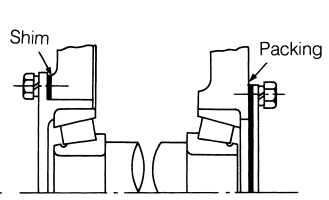

Fig. 8.27 Examples of Clearance Adjusted by Shim Thickness of Outer Ring Cover

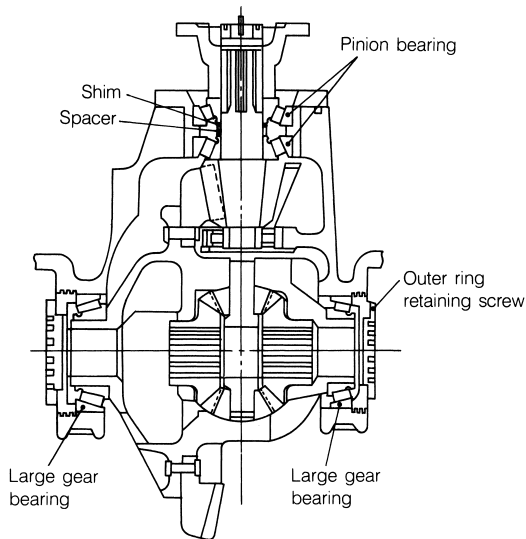

Fig. 8.28 Automotive Final Reduction Gear

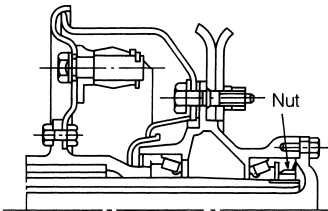

Fig. 8.29 Rear Wheel of Truck

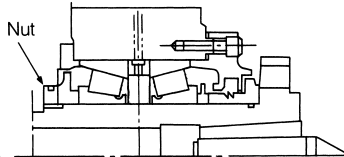

Fig. 8.30 Head Spindle of Lathe

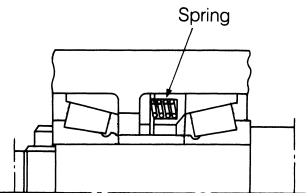
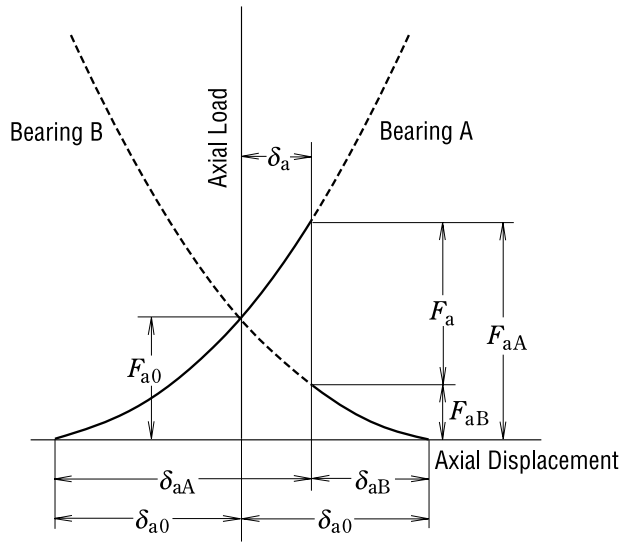
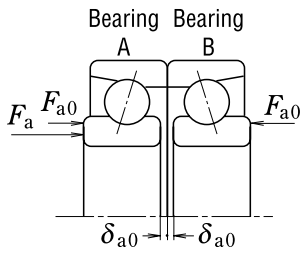

Fig. 8.31 Constant Pressure Preload Applied by Spring



9. PRELOAD

9.1 Purpose of Preload	A 192
9.2 Preloading Methods	A 192
9.2.1 Position Preload	A 192
9.2.2 Constant-Pressure Preload	A 192
9.3 Preload and Rigidity	A 192
9.3.1 Position Preload and Rigidity	A 192
9.3.2 Constant-Pressure Preload and Rigidity	A 193
9.4 Selection of Preloading Method and Amount of Preload	A 193
9.4.1 Comparison of Preloading Methods	A 193
9.5 Amount of Preload	A 194
9.5.1 Average Preload for Duplex Angular Contact Ball Bearings	A 194
9.5.2 Preload of Thrust Ball Bearings	A 198
9.5.3 Preload of Spherical Thrust Roller Bearings	A 198
9.6 Technical Data	A 200
9.6.1 Load and Displacement of Position-Preloaded Bearings	A 200
9.6.2 Axial Displacement of Deep Groove Ball Bearings	A 208
9.6.3 Axial Displacement of Tapered Roller Bearings	A 212

9. Preload

Rolling bearings usually retain some internal clearance while in operation. In some cases, however, it is desirable to provide a negative clearance to keep them internally stressed. This is called "preloading". A preload is usually applied to bearings in which the clearance can be adjusted during mounting, such as angular contact ball bearings or tapered roller bearings. Usually, two bearings are mounted face-to-face or back-to-back to form a duplex set with a preload.

9.1 Purpose of Preload

The main purposes and some typical applications of preloaded bearings are as follows:

- (1) To maintain the bearings in exact position both radially and axially and to maintain the running accuracy of the shaft.
...Main shafts of machine tools, precision instruments, etc.
- (2) To increase bearing rigidity
...Main shafts of machine tools, pinion shafts of final drive gears of automobiles, etc.
- (3) To minimize noise due to axial vibration and resonance
...Small electric motors, etc.
- (4) To prevent sliding between the rolling elements and raceways due to gyroscopic moments
...High speed or high acceleration applications of angular contact ball bearings, and thrust ball bearings
- (5) To maintain the rolling elements in their proper position with the bearing rings
...Thrust ball bearings and spherical thrust roller bearings mounted on a horizontal shaft

9.2 Preloading Methods

9.2.1 Position Preload

A position preload is achieved by fixing two axially opposed bearings in such a way that a preload is imposed on them. Their position, once fixed, remain unchanged while in operation.

In practice, the following three methods are generally used to obtain a position preload.

- (1) By installing a duplex bearing set with previously adjusted stand-out dimensions (see Page A007 Fig. 1.1) and axial clearance.
- (2) By using a spacer or shim of proper size to obtain the required spacing and preload. (Refer to Fig. 9.1)
- (3) By utilizing bolts or nuts to allow adjustment of the axial preload. In this case, the starting torque should be measured to verify the proper preload.

9.2.2 Constant-Pressure Preload

A constant pressure preload is achieved using a coil or leaf spring to impose a constant preload. Even if the relative position of the bearings changes during operation, the magnitude of the preload remains relatively constant (refer to Fig. 9.2)

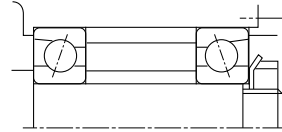

Fig. 9.1 Position Preload

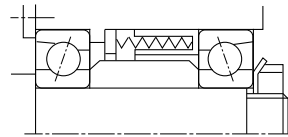

Fig. 9.2 Constant-Pressure Preload

9.3 Preload and Rigidity

9.3.1 Position Preload and Rigidity

When the inner rings of the duplex bearings shown in Fig. 9.3 are fixed axially, bearings A and B are displaced δ_{a0} and axial space $2\delta_{a0}$ between the inner rings is eliminated. With this condition, a preload F_{a0} is imposed on each bearing. A preload diagram showing bearing rigidity, that is the relation between load and displacement with a given axial load F_a imposed on a duplex set, is shown in Fig. 9.4.

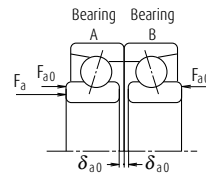

Fig. 9.3 Back-to-Back Duplex Bearing Preload

9.3.2 Constant-Pressure Preload and Rigidity

A preload diagram for duplex bearings under a constant-pressure preload is shown in Fig. 9.5. The deflection curve of the spring is nearly parallel to the horizontal axis because the rigidity of springs is lower than that of the bearing. As a result, the rigidity under a constant-pressure preload is approximately equal to that for a single bearing with a preload F_{a0} applied to it. Fig. 9.6 presents a comparison of the rigidity of a bearing with a position preload and one with a constant-pressure preload.

9.4 Selection of Preloading Method and Amount of Preload

9.4.1 Comparison of Preloading Methods

A comparison of the rigidity using both preloading methods is shown in Fig. 9.6. The position preload and constant-pressure preload may be compared as follows:

- (1) When both of the preloads are equal, the position preload provides greater bearing rigidity, in other words, the deflection due to external loads is less for bearings with a position preload.
- (2) In the case of a position preload, the preload varies depending on such factors as a difference in axial expansion due to a temperature difference between the shaft and housing, a difference in radial expansion due to a temperature difference between the inner and outer rings, deflection due to load, etc.

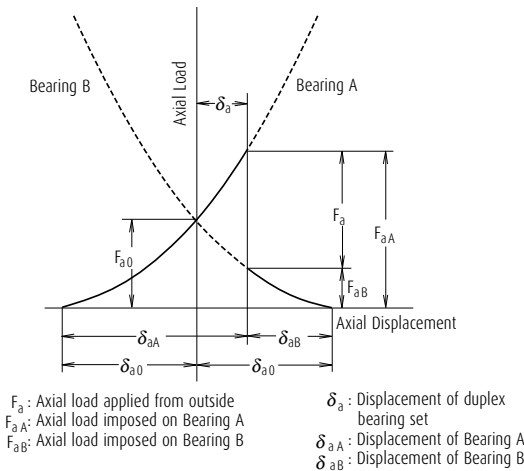

Fig. 9.4 Axial Displacement with Position Preload

In the case of a constant-pressure preload, it is possible to minimize any change in the preload because the variation of the spring load with shaft expansion and contraction is negligible. From the foregoing explanation, it is seen that position preloads are generally preferred for increasing rigidity and constant-pressure preloads are more suitable for high speed applications, for prevention of axial vibration, for use with thrust bearings on horizontal shafts, etc.

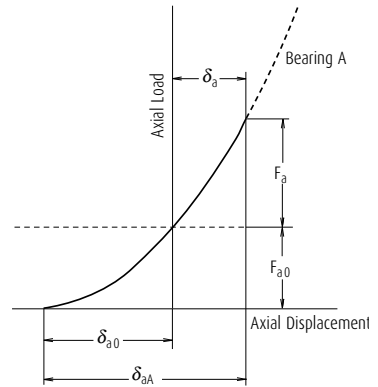

Fig. 9.5 Axial Displacement with Constant-Pressure Preload

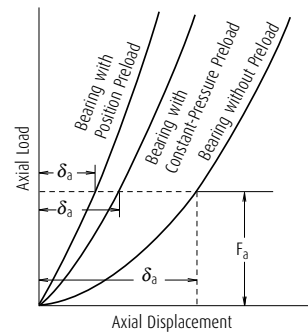

Fig. 9.6 Comparison of Rigidities and Preloading Methods

9.5 Amount of Preload

If the preload is larger than necessary, abnormal heat generation, increased frictional torque, reduced fatigue life, etc. may occur. The amount of the preload should be carefully determined considering the operating conditions and the purpose of the preload.

9.5.1 Average Preload for Duplex Angular Contact Ball Bearings

Angular contact ball bearings are widely used in spindles for grinding, milling, high-speed turning, etc. At NSK, preloads are divided into four graduated classifications — Extra light (EL), Light (L), Medium (M), and Heavy (H) — to allow the customer to freely choose the appropriate preload for the specific application. These four preload classes are expressed in symbols, EL, L, M, and H, respectively, when applied to DB and DF bearing sets.

The average preload and axial clearance (measured) for duplex angular contact ball bearing sets with contact angles 15° and 30° (widely used on machine tool spindles) are given in Tables 9.3 to 9.5. The measuring load when measuring axial clearance is shown in Table 9.1.

The recommended axial clearance to achieve the proper preload was determined for machine-tool spindles and other applications requiring ISO Class 5 and above high-precision bearing sets. The standard values given in Table 9.2 are used for the shaft — inner ring and housing — outer ring fits. The housing fits should be selected in the lower part of the standard clearance for bearings in fixed-end applications and the higher part of the standard clearance for bearings in free-end applications.

As general rules when selecting preloads, grinding machine spindles or machining center spindles require extra light to light preloads, whereas lathe spindles, which need rigidity, require medium preloads. The bearing preloads, if the bearing set is mounted with tight fit, are larger than those shown in Tables 9.3 to 9.5. Since excessive preloads cause bearing temperature rise and seizure, etc., it is necessary to pay attention to fitting. When speeds result in a value of $D_{pw} \times n$ ($d_{m,n}$ value) higher than 500000, the preload should be very carefully studied and selected. In such a case, please consult with NSK beforehand.

Table 9.1 Measuring Load of Axial Clearance

Nominal bearing outside diameter D (mm)		Measuring load (N)
over	incl.	(N)
10*	50	24.5
50	120	49
120	200	98
200	—	196

*10 mm is included in this range.

Table 9.2 Target of Fitting

Units : μm

Bore or outside diameter d or D (mm)		Shaft and inner ring	Housing and outer ring
over	incl.	Target interference	Target clearance
—	18	0 to 2	—
18	30	0 to 2.5	2 to 6
30	50	0 to 2.5	2 to 6
50	80	0 to 3	3 to 8
80	120	0 to 4	3 to 9
120	150	—	4 to 12
150	180	—	4 to 12
180	250	—	5 to 15

Table 9.3 Average Preloads and Axial Clearance for Bearing Series 79C

Bearing No.	Extra light EL		Light L		Medium M		Heavy H	
	Preload	Axial clearance	Preload	Axial clearance	Preload	Axial clearance	Preload	Axial clearance
	(N)	(μm)	(N)	(μm)	(N)	(μm)	(N)	(μm)
7900 C	7	5	16	2	29	-1	58	-6
7901 C	8.6	4	15	2	41	-3	77	-8
7902 C	12	3	25	0	47	-4	104	-11
7903 C	11	3	25	0	56	-5	119	-12
7904 C	20	1	42	-3	80	-8	152	-15
7905 C	19	1	37	-2	99	-9	203	-17
7906 C	25	0	46	-3	95	-8	204	-16
7907 C	33	2	67	-2	149	-9	297	-18
7908 C	41	1	78	-3	196	-12	384	-22
7909 C	49	0	104	-5	192	-11	391	-21
7910 C	49	0	95	-4	240	-13	499	-24
7911 C	60	-1	111	-5	296	-15	593	-26
7912 C	60	-1	113	-5	305	-15	581	-25
7913 C	74	-2	151	-7	348	-16	690	-27
7914 C	101	-4	205	-10	503	-22	1 004	-36
7915 C	103	-4	190	-9	489	-21	997	-35
7916 C	104	-4	195	-9	503	-21	986	-34
7917 C	138	-6	307	-14	629	-25	1 281	-41
7918 C	153	-3	289	-9	740	-23	1 488	-39
7919 C	154	-3	294	-9	800	-24	1 588	-40
7920 C	191	-5	387	-13	905	-28	1 790	-46

Remark In the axial clearance column, the measured value is given.

Table 9.4 Average Preloads and Axial Clearance for Bearing Series 70C

Bearing No.	Extra light EL		Light L		Medium M		Heavy H	
	Preload	Axial clearance	Preload	Axial clearance	Preload	Axial clearance	Preload	Axial clearance
	(N)	(μm)	(N)	(μm)	(N)	(μm)	(N)	(μm)
7000 C	13	3	25	0	49	-5	96	-12
7001 C	13	3	25	0	57	-6	120	-14
7002 C	12	3	29	-1	66	-7	147	-16
7003 C	15	2	30	-1	69	-7	156	-16
7004 C	25	0	49	-4	119	-12	244	-22
7005 C	30	-1	58	-5	148	-14	292	-24
7006 C	41	1	75	-3	195	-13	386	-24
7007 C	58	-1	121	-7	251	-16	493	-28
7008 C	58	-1	114	-6	291	-17	594	-30
7009 C	80	-3	144	-8	338	-19	695	-33
7010 C	70	-2	152	-8	388	-20	791	-34
7011 C	95	-4	200	-11	479	-24	971	-40
7012 C	96	-4	189	-10	526	-25	1 092	-42
7013 C	130	-6	260	-13	537	-24	1 062	-39
7014 C	148	-7	285	-14	732	-30	1 460	-48
7015 C	151	-7	294	-14	796	-31	1 573	-49
7016 C	202	-6	382	-14	921	-31	1 880	-52
7017 C	205	-6	393	-14	995	-32	1 956	-52
7018 C	247	-8	502	-18	1 187	-37	2 373	-60
7019 C	275	-9	549	-19	1 188	-36	2 348	-58
7020 C	282	-9	534	-18	1 278	-37	2 572	-60

Remark In the axial clearance column, the measured value is given.

Table 9.5 Average Preloads and Axial Clearance for Bearing Series 72C

Bearing No.	Extra light EL		Light L		Medium M		Heavy H	
	Preload	Axial clearance	Preload	Axial clearance	Preload	Axial clearance	Preload	Axial clearance
	(N)	(μm)	(N)	(μm)	(N)	(μm)	(N)	(μm)
7200 C	13	3	29	-1	68	-8	150	-18
7201 C	20	1	39	-3	99	-12	197	-22
7202 C	20	1	40	-3	97	-11	199	-21
7203 C	25	0	46	-4	146	-16	296	-28
7204 C	35	-2	68	-7	196	-20	384	-33
7205 C	42	1	82	-4	193	-14	402	-27
7206 C	57	-1	114	-7	292	-20	591	-35
7207 C	75	-3	151	-10	385	-25	794	-43
7208 C	98	-5	202	-13	501	-29	985	-47
7209 C	123	-7	254	-16	534	-30	1 067	-49
7210 C	127	-7	248	-15	590	-31	1 171	-50
7211 C	142	-8	289	-17	788	-38	1 554	-60
7212 C	190	-11	397	-22	928	-42	1 878	-67
7213 C	219	-12	448	-23	1 069	-44	2 175	-70
7214 C	243	-9	484	-20	1 164	-42	2 368	-69
7215 C	270	-10	530	-21	1 224	-42	2 445	-68
7216 C	305	-12	595	-24	1 367	-47	2 752	-76
7217 C	355	-14	697	-27	1 658	-53	3 358	-85
7218 C	384	-15	771	-29	1 865	-57	3 713	-90
7219 C	448	-18	876	-33	2 081	-63	4 153	-99
7220 C	503	-20	984	-36	2 337	-68	4 700	-107

Remark In the axial clearance column, the measured value is given.

9.5.2 Preload of Thrust Ball Bearings

When the balls in thrust ball bearings rotate at relatively high speeds, sliding due to gyroscopic moments on the balls may occur. The larger of the two values obtained from Equations (9.1) and (9.2) below should be adopted as the minimum axial load in order to prevent such sliding

$$F_{a \min} = \frac{C_{0a}}{100} \left(\frac{n}{N_{\max}} \right)^2 \dots\dots\dots (9.1)$$

$$F_{a \min} = \frac{C_{0a}}{1000} \dots\dots\dots (9.2)$$

- where $F_{a \min}$: Minimum axial load (N), {kgf}
- n : Speed (min⁻¹)
- C_{0a} : Basic static load rating (N), {kgf}
- N_{\max} : Limiting speed (oil lubrication) (min⁻¹)

9.5.3 Preload of Spherical Thrust Roller Bearings

When spherical thrust roller bearings are used, damage such as scoring may occur due to sliding between the rollers and outer ring raceway. The minimum axial load $F_{a \min}$ necessary to prevent such sliding is obtained from the following equation:

$$F_{a \min} = \frac{C_{0a}}{1000} \dots\dots\dots (9.3)$$



9.6 Technical Data

9.6.1 Load and Displacement of Position-Preloaded Bearings

Two (or more) ball or tapered roller bearings mounted side by side as a set are termed duplex (or multiple) bearing sets. The bearings most often used in multiple arrangements are single-row angular contact ball bearings for machine tool spindles, since there is a requirement to reduce the bearing displacement under load as much as possible. There are various ways of assembling sets depending on the effect desired. Duplex angular contact bearings fall into three types of arrangements, Back-to-Back, with lines of force convergent on the bearing back faces, Face-to-Face, with lines of force convergent on the bearing front faces, and Tandem, with lines of force being parallel. The symbols for these are DB, DF, and DT arrangements respectively (Fig. 9.7).

DB and DF arrangement sets can take axial loads in either direction. Since the distance of the load centers of DB bearing set is longer than that of DF bearing set, they are widely used in applications where there is a moment. DT type sets can only take axial loads in one direction. However, because the two bearings share some load equally between them, a set can be used where the load in one direction is large.

By selecting the DB or DF bearing sets with the proper preloads which have already been adjusted to an appropriate range by the bearing manufacturer, the radial and axial displacements of the bearing inner and outer ring can be reduced as much as allowed by certain limits. However, the DT bearing set cannot be preloaded.

The amount of preload can be adjusted by changing clearance between bearings, δ_{a0} , as shown in Figs. 9.9 to 9.11. Preloads are divided into four graduated classification — Extra light (EL), Light (L), Medium (M), and Heavy (H). Therefore, DB and DF bearing sets are often used for applications where shaft misalignments and displacements due to loads must be minimized.

Triplex sets are also available in three types (symbols: DBD, DFD, and DTD) of arrangements as shown in Fig. 9.8. Sets of four or five bearings can also be used depending on the application requirements. Duplex bearings are often used with a preload applied. Since the preload affects the rise in bearing temperature during operation, torque, bearing noise, and especially bearing life, it is extremely important to avoid applying an excessive preload. Generally, the axial displacement δ_a under an axial load F_a for single-row angular contact ball bearings is calculated as follows,

$$\delta_a = c F_a^{2/3} \dots\dots\dots (9.4)$$

where, c: Constant depending on the bearing type and dimensions.

Fig. 9.9 shows the preload curves of duplex DB arrangement, and Figs. 9.10 and 9.11 show those for triplex DBD arrangement.

If the inner rings of the duplex bearing set in Fig. 9.9 are pressed axially, A-side and B-side bearings are deformed δ_{a0A} and δ_{a0B} respectively and the clearance (between the inner rings), δ_{a0} , becomes zero. This condition means that the preload F_{a0} is applied on the bearing set. If an external axial load F_a is applied on the preloaded bearing set from the A-side, then the A-side bearing will be deformed δ_{a1} additionally and the displacement of B-side bearing will be reduced to the same amount as the A-side bearing displacement δ_{a1} . Therefore, the displacements of A- and B-side bearings are $\delta_{aA} = \delta_{a0A} + \delta_{a1}$ and $\delta_{aB} = \delta_{a0B} + \delta_{a1}$ respectively. That is, the load on A-side bearing including the preload is $(F_{a0} + F_a - F_a')$ and the B-side bearing is $(F_{a0} - F_a')$.

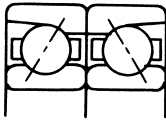

DB

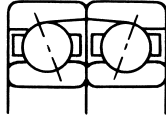

DF

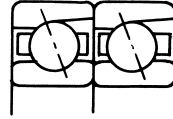

DT

Fig. 9.7 Duplex Bearing Arrangements

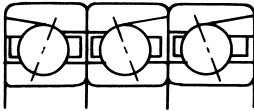

DBD

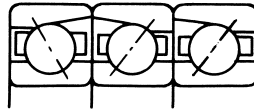

DFD

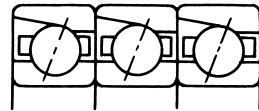

DTD

Fig. 9.8 Triplex Bearing Arrangements

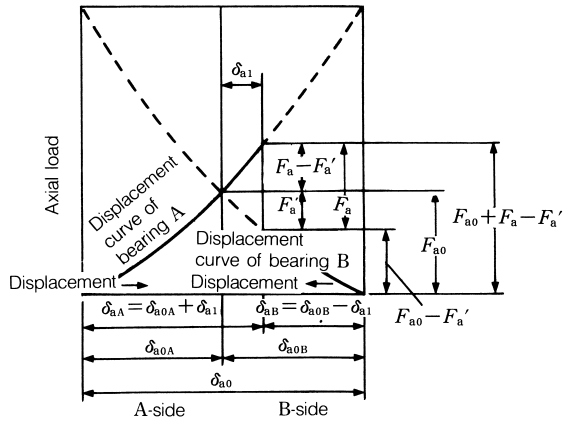
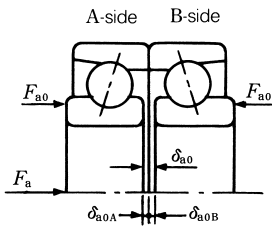

Fig. 9.9 Preload Graph of DB Arrangement Duplex Bearings

Preload

If the bearing set has an applied preload, the A-side bearing should have a sufficient life and load capacity for an axial load ($F_{a0} + F_a - F_a'$) under the speed condition. The axial clearance δ_{a0} is shown in Tables 9.3 to 9.5 of Section 9.5.1 (Pages A195 to A197).

In Fig. 9.10, with an external axial load F_a applied on the AA-side bearings, the axial loads and displacements of AA- and B-side bearings are summarized in Table 9.6.

In Fig. 9.11, with an external axial load F_a applied on the A-side bearing, the axial loads and displacements of A- and BB-side bearings are summarized in Table 9.7.

The examples, Figs. 9.12 to 9.17, show the relation of the axial loads and axial displacements using duplex DB and triplex DBD arrangements of 7018C and 7018A bearings under several preload ranges.

Table 9.6

Direction	Displacement	Axial load
AA-side	$\delta_{a0A} + \delta_{a1}$	$F_{a0} + F_a - F_a'$
B-side	$\delta_{a0B} - \delta_{a1}$	$F_{a0} - F_a'$

Table 9.7

Direction	Displacement	Axial load
A-side	$\delta_{a0A} + \delta_{a1}$	$F_{a0} + F_a - F_a'$
BB-side	$\delta_{a0B} - \delta_{a1}$	$F_{a0} - F_a'$

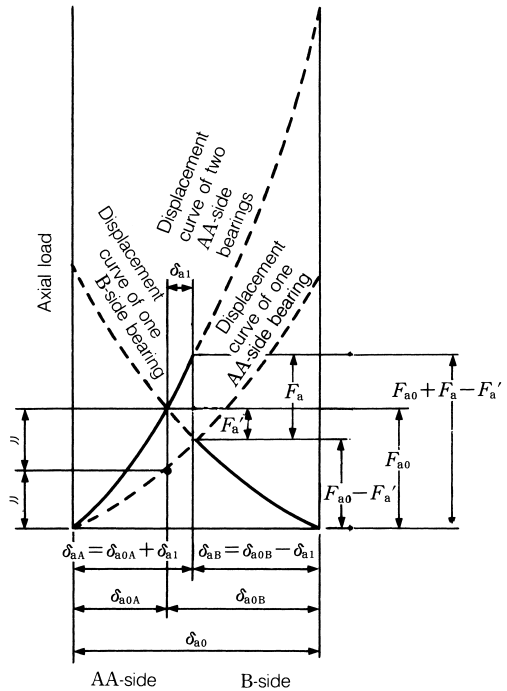
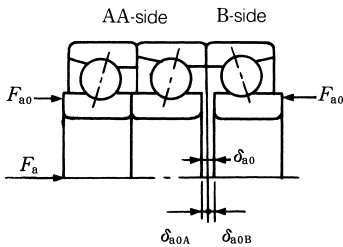

Fig. 9.10 Preload Graph of Triplex DBD Bearing Set (Axial load is applied from AA-side)

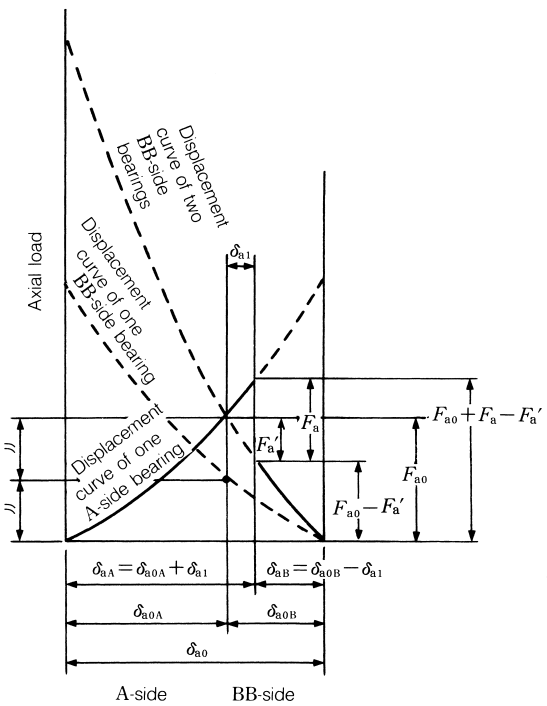
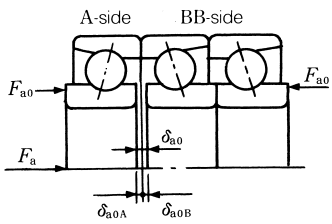

Fig. 9.11 Preload Graph of Triplex DBD Bearing set (Axial load is applied from A-side)

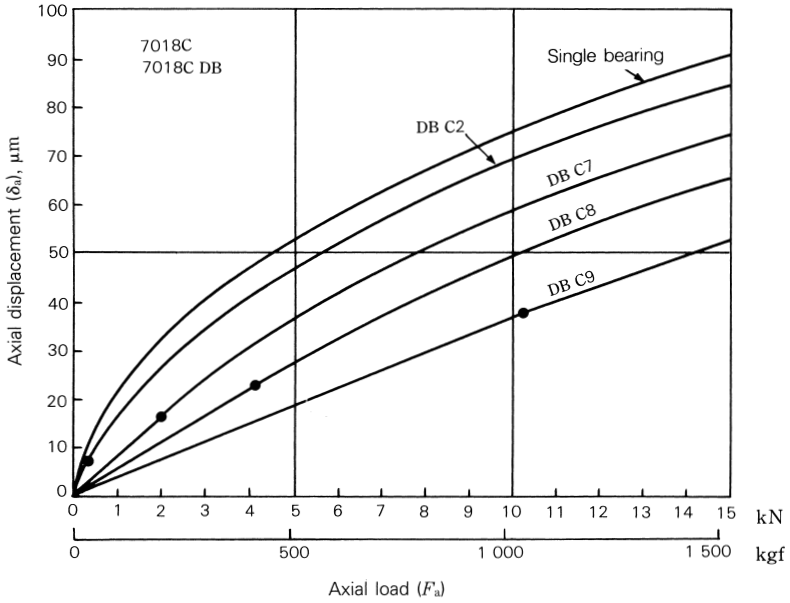

Fig. 9.12

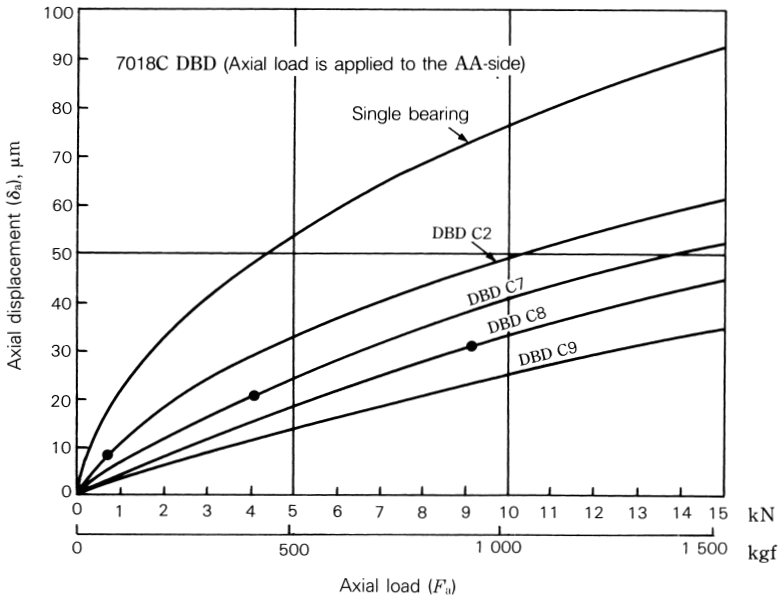

Fig. 9.13

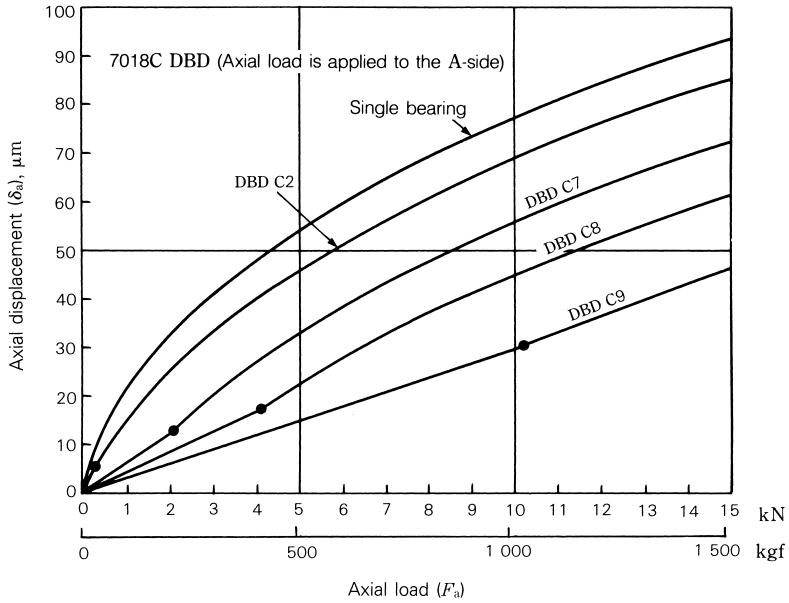

Fig. 9.14

Remark A (•) mark on the axial load or displacement curve indicates the point where the preload is zero. Therefore, if the axial load is larger than this, the opposed bearing does not impose a load.

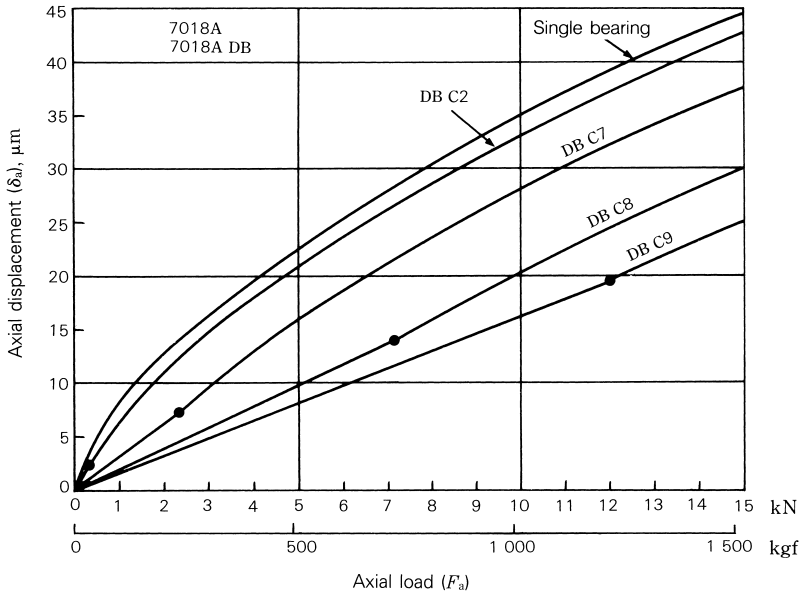

Fig. 9.15

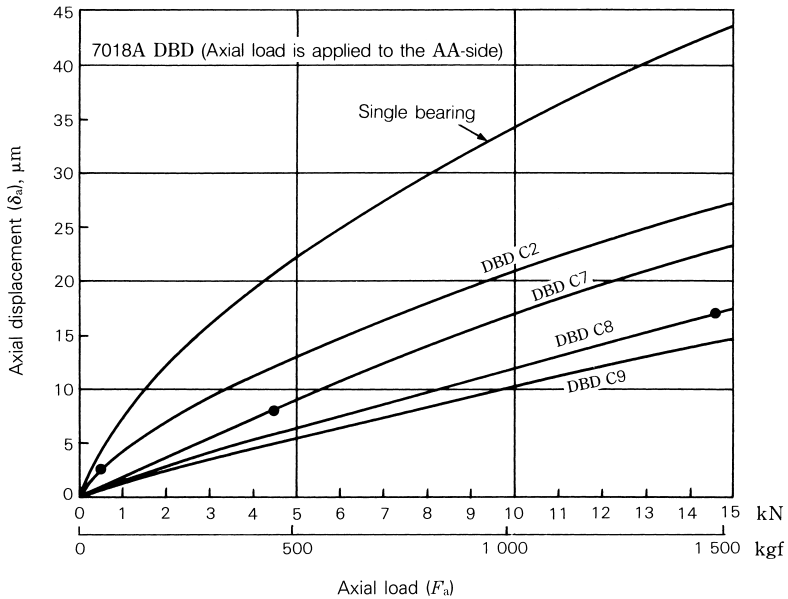

Fig. 9.16

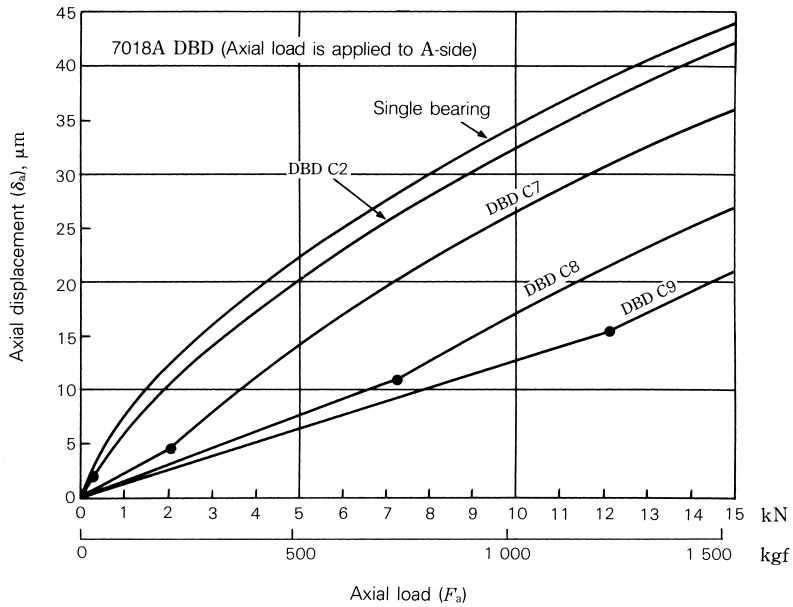

Fig. 9.17

Remark A (●) mark on the axial load or displacement curve indicates the point where the preload is zero. Therefore, if the axial load is larger than this, the opposed bearing does not impose a load.

9.6.2 Axial Displacement of Deep Groove Ball Bearings

When an axial load F_a is applied to a radial bearing with a contact angle α_0 and the inner ring is displaced δ_a , the center O_i of the inner ring raceway radius is also moved to O_i' resulting in the contact angle α as shown in Fig. 9.18. If δ_N represents the elastic deformation of the raceway and ball in the direction of the rolling element load Q , Equation (9.5) is derived from Fig. 9.18.

$$(m_0 + d_N)^2 = (m_0 \cdot \sin\alpha_0 + \delta_a)^2 + (m_0 \cdot \cos\alpha_0)^2$$

$$\therefore \delta_N = m_0 \left\{ \sqrt{\left(\sin\alpha_0 + \frac{\delta_a}{m_0}\right)^2 + \cos^2\alpha_0} - 1 \right\} \dots\dots\dots (9.5)$$

Also there is the following relationship between the rolling element load Q and elastic deformation δ_N .

$$Q = K_N \cdot \delta_N^{3/2} \dots\dots\dots (9.6)$$

where, K_N : Constant depending on bearing material, type, and dimension

\therefore If we introduce the relation of

$$m_0 = \left(\frac{r_e}{D_w} + \frac{r_i}{D_w} - 1 \right) D_w = B \cdot D_w$$

Equations (9.5) and (9.6) are,

$$Q = K_N (B \cdot D_w)^{3/2} \left\{ \sqrt{(\sin\alpha_0 + h)^2 + \cos^2\alpha_0} - 1 \right\}^{3/2}$$

where, $h = \frac{\delta_a}{m_0} = \frac{\delta_a}{B \cdot D_w}$

If we introduce the relation of $K_N = K \cdot \frac{\sqrt{D_w}}{B^{3/2}}$

$$Q = K \cdot D_w^2 \left\{ \sqrt{(\sin\alpha_0 + h)^2 + \cos^2\alpha_0} - 1 \right\}^{3/2} \dots\dots\dots (9.7)$$

On the other hand, the relation between the bearing axial load and rolling element load is shown in Equation (9.8) using Fig. 9.19:

$$F_a = Z \cdot Q \cdot \sin\alpha \dots\dots\dots (9.8)$$

Based on Fig. 9.18, we obtain,

$$(m_0 + \delta_N) \sin\alpha = m_0 \cdot \sin\alpha_0 + \delta_a$$

$$\therefore \sin\alpha = \frac{m_0 \cdot \sin\alpha_0 + \delta_a}{m_0 + \delta_N} = \frac{\sin\alpha_0 + h}{1 + \frac{\delta_N}{m_0}}$$

If we substitute Equation (9.5),

$$\sin\alpha = \frac{\sin\alpha_0 + h}{\sqrt{(\sin\alpha_0 + h)^2 + \cos^2\alpha_0}} \dots\dots\dots (9.9)$$

That is, the relation between the bearing axial load F_a and axial displacement δ_a can be obtained by substituting Equations (9.7) and (9.9) for Equation (9.8).

$$F_a = K \cdot Z \cdot D_w^2 \cdot \frac{\{ \sqrt{(\sin\alpha_0 + h)^2 + \cos^2\alpha_0} - 1 \}^{3/2} \times (\sin\alpha_0 + h)}{\sqrt{(\sin\alpha_0 + h)^2 + \cos^2\alpha_0}} \dots\dots\dots (9.10)$$

where, K : Constant depending on the bearing material and design

D_w : Ball diameter

Z : Number of balls

α_0 : Initial contact angle

In case of single-row deep groove ball bearings, the initial contact angle can be obtained using Equation (5) of Page B012

$$\alpha = \cos^{-1} \left(\frac{r_e + r_i - D_w - \frac{d}{2}}{r_e + r_i - D_w} \right) \dots\dots\dots (9.11)$$

$$= \sin^{-1} \left(\frac{d/2}{r_e + r_i - D_w} \right) \dots\dots\dots (9.12)$$

Actual axial deformation varies depending on the bearing mounting conditions, such as the material and thickness of the shaft and housing, and bearing fitting. For details, consult with NSK regarding the axial deformation after mounting.

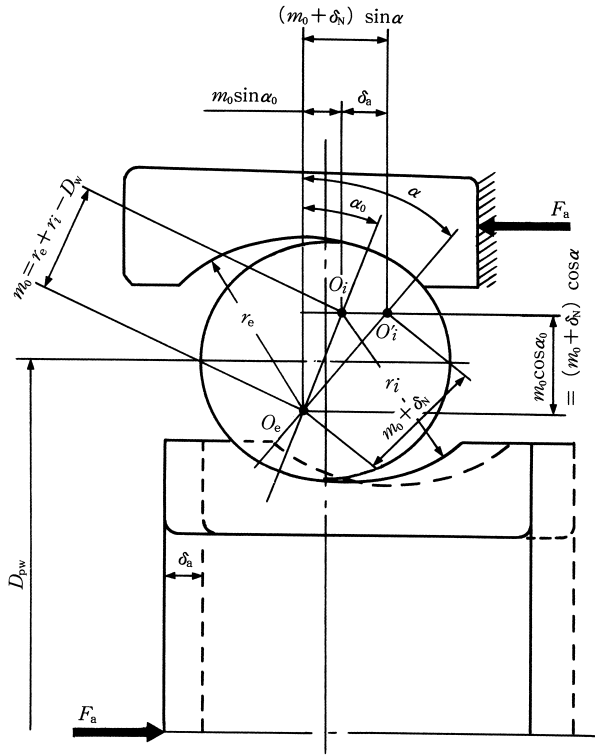

Fig. 9.18

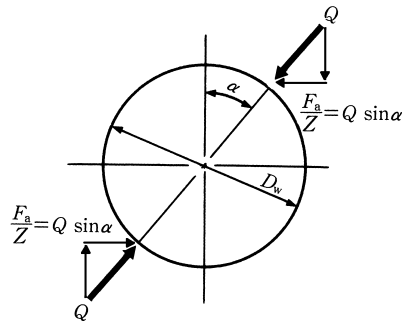

Fig. 9.19

Preload

Fig. 9.20 gives the relation between axial load and axial displacement for 6210 and 6310 single-row deep groove ball bearings with initial contact angles of $\alpha_0=0^\circ$, 10° , 15° . The larger the initial contact angle α_0 , the more rigid the bearing will be in the axial direction and also the smaller the difference between the axial displacements of 6210 and 6310 under the same axial load. The angle α_0 depends upon the groove radius and the radial clearance.

Fig. 9.21 gives the relation between axial load and axial displacement for 72 series angular contact ball bearings with initial contact angles of 15° (C), 30° (A), and 40° (B). Because 70 and 73 series bearings with identical contact angles and bore diameters can be considered to have almost the same values as 72 series bearings. Angular contact ball bearings that sustain loads in the axial direction must maintain their running accuracy and reduce the bearing elastic deformation from applied loads when used as multiple bearing sets with a preload applied.

To determine the preload to keep the elastic deformation caused by applied loads within the required limits, it is important to know the characteristics of load vs. deformation. The relationship between load and displacement can be expressed by Equation (9.10) as $F_a \propto \delta_a^{2/3}$ or $\delta_a \propto F_a^{3/2}$. That is, the axial displacement δ_a is proportional to the axial load F_a to the 2/3 power. When this axial load index is less than one, it indicates the relative axial displacement will be small with only a small increase in the axial load. (Fig. 9.21) The underlying reason for applying a preload is to reduce the amount of displacement.

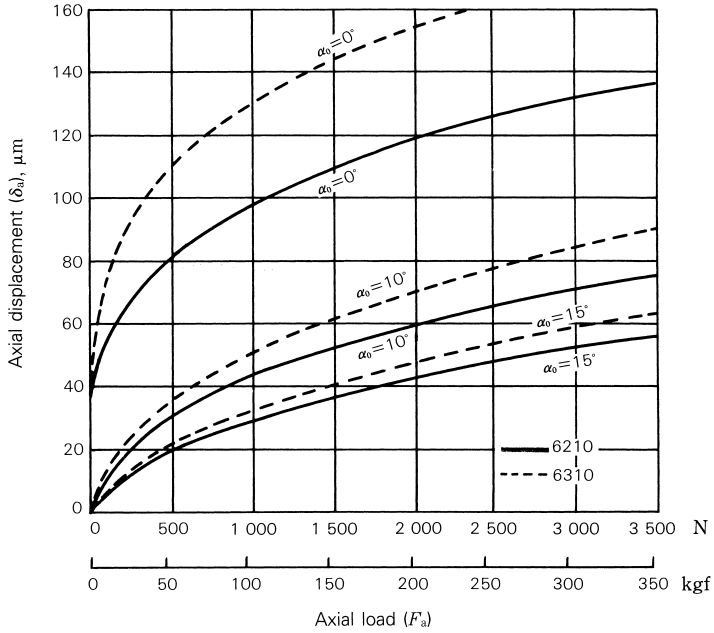

Fig. 9.20 Axial Load and Axial Displacement of Deep Groove Ball Bearings

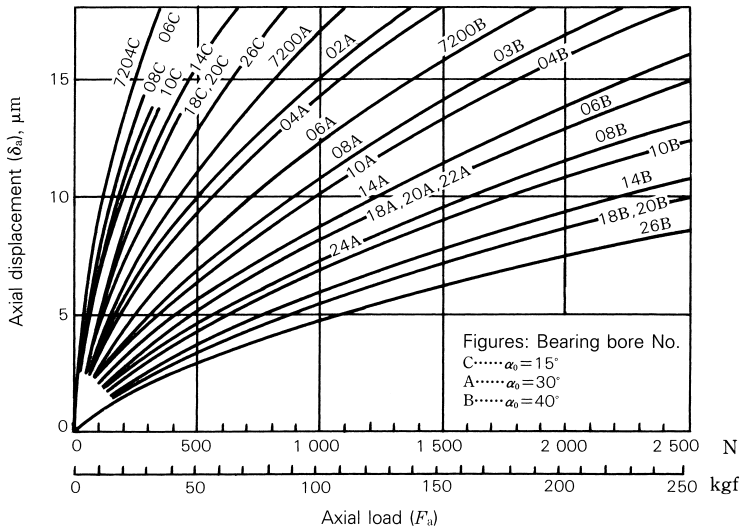

Fig. 9.21 Axial Load and Axial Displacement of Angular Contact Ball Bearings

9.6.3 Axial Displacement of Tapered Roller Bearings

Tapered roller bearings are widely used in pairs like angular contact ball bearings. Care should be taken to select appropriate tapered roller bearings. For example, the bearings of machine tool head spindles and automobile differential pinions are preloaded to increase shaft rigidity. When a bearing with an applied preload is to be used in an application, it is essential to have some knowledge of the relationship between axial load and axial displacement.

For tapered roller bearings, the axial displacement calculated using Palmgren's method, Equation (9.11) generally agrees well with actual measured values. Actual axial deformation varies depending on the bearing mounting conditions, such as the material and thickness of the shaft and housing, and bearing fitting. For details, consult with NSK regarding the axial deformation after mounting.

$$\delta_a = \frac{0.000077}{\sin\alpha} \cdot \frac{Q^{0.9}}{L_{we}^{0.8}} \quad \text{(N)} \quad \dots\dots\dots(9.13)$$

$$= \frac{0.0006}{\sin\alpha} \cdot \frac{Q^{0.9}}{L_{we}^{0.8}} \quad \text{{kgf}}$$

where, δ_a : Axial displacement of inner, outer ring (mm)

α : Contact angle...1/2 the cup angle (°)
(Refer to Fig. 9.22)

Q: Load on rolling elements (N), {kgf}

$$Q = \frac{F_a}{Z \sin\alpha}$$

L_{we} : Length of effective contact on roller (mm)

F_a : Axial load (N), {kgf}

Z: Number of rollers

Equation (9.11) can also be expressed as Equation (9.12).

$$\delta_a = K_a \cdot F_a^{0.9} \quad \dots\dots\dots(9.14)$$

where,

$$K_a = \frac{0.000077}{(\sin\alpha)^{1.9} Z^{0.9} L_{we}^{0.8}} \quad \dots\dots\dots(N)$$

$$= \frac{0.0006}{(\sin\alpha)^{1.9} Z^{0.9} L_{we}^{0.8}} \quad \dots\dots\dots\{kgf\}$$

Here, K_a : Coefficient determined by the bearing internal design.

Axial loads and axial displacement for tapered roller bearings are plotted in Fig. 9.23. The amount of axial displacement of tapered roller bearings is proportional to the axial load raised to the 0.9 power. The displacement of ball bearings is proportional to the axial load raised to the 0.67 power, thus the preload required to control displacement is much greater for ball bearings than for tapered roller bearings. Caution should be taken not to make the preload indiscriminately large on tapered roller bearings, since too large of a preload can cause excessive heat, seizure, and reduced bearing life.

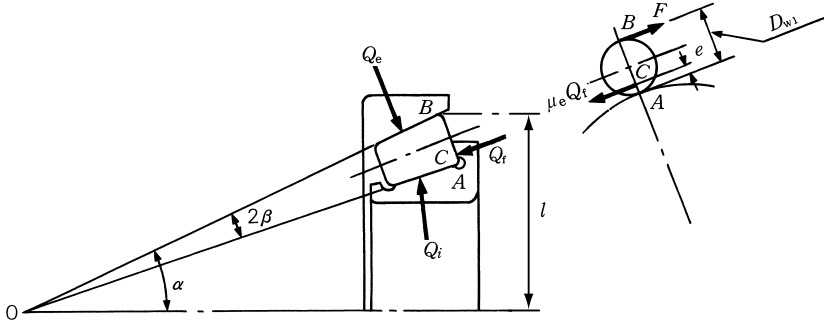

Fig. 9.22

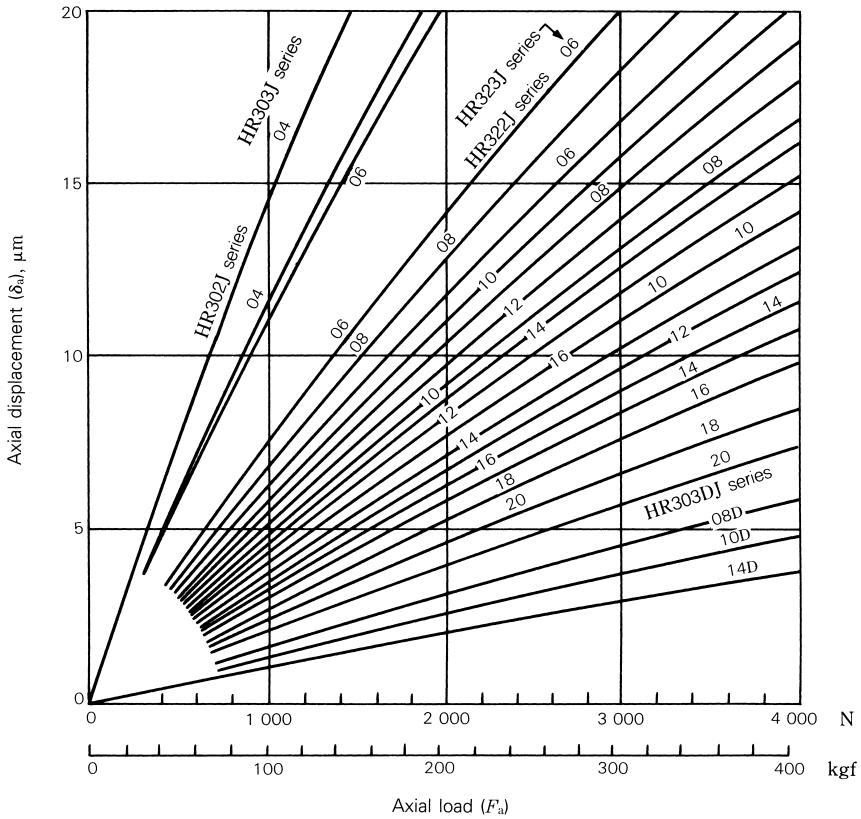
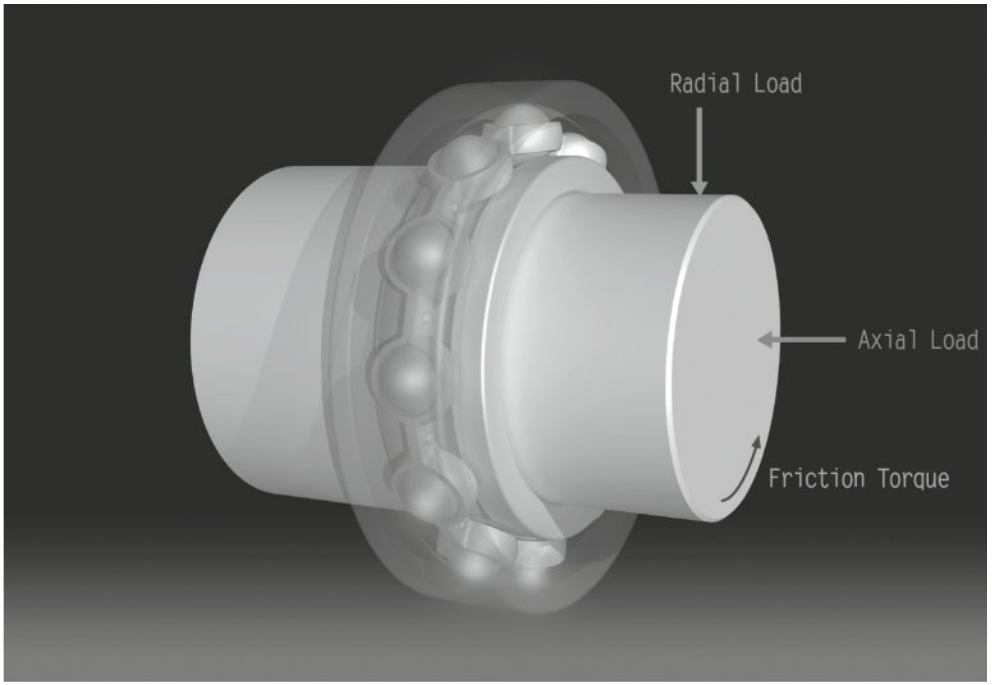

Fig. 9.23 Axial Load and Axial Displacement for Tapered Roller Bearings



10. FRICTION

10.1	Coefficients of Dynamic Friction	A 216
10.1.1	Bearing Types and Their Coefficients of Dynamic Friction μ	A 216
10.2	Empirical Equations for Running Torque	A 216
10.3	Technical Data	A 216
10.3.1	Preload and Starting Torque for Angular Contact Ball Bearings	A 216
10.3.2	Empirical Equations of Running Torque of High-Speed Ball Bearings	A 218
10.3.3	Preload and Starting Torque for Tapered Roller Bearings	A 220
10.3.4	Empirical Equations for Running Torque of Tapered Roller Bearings	A 222

10. Friction

10.1 Coefficients of Dynamic Friction

10.1.1 Bearing Types and Their Coefficients of Dynamic Friction μ

$$\mu = \frac{M}{P \cdot \frac{d}{2}} \dots\dots\dots(10.1)$$

- M : Dynamic friction torque (N-mm), (kgf-mm)
- P : Bearing load (Dynamic equivalent load) (N), {kgf}
- d : Shaft diameter, Inner ring bore diameter (mm)

Table 10.1 Coefficients of Dynamic Friction

Bearing Types	Approximate values of μ
Deep Groove Ball Bearings	0.0013
Angular Contact Ball Bearings	0.0015
Self-Aligning Ball Bearings	0.0010
Thrust Ball Bearings	0.0011
Cylindrical Roller Bearings	0.0010
Tapered Roller Bearings	0.0022
Spherical Roller Bearings	0.0028
Needle Roller Bearings with Cages	0.0015
Full Complement Needle Roller Bearings	0.0025
Spherical Thrust Roller Bearings	0.0028

10.2 Empirical Equations for Running Torque

Dynamic torque of bearing (heat generation)
 $M = M_1 + M_v$

- Load term (Determined by bearing type and load)
 $M_1 = f_1 F d_m$
 where f_1 : Coefficient determined by bearing type and load
 F : Load
 d_m : Pitch circle diameter of rolling element
- Speed term (Determined by oil viscosity, amount, speed)
 $M_v = f_0 (v_0 n)^{2/3} d m^3$
 where f_0 : Coefficient determined by bearing and lubricating method
 v_0 : Kinematic viscosity of oil
 n : Speed

10.3 Technical Data

10.3.1 Preload and Starting Torque for Angular Contact Ball Bearings

Angular contact ball bearings, like tapered roller bearings, are most often used in pairs rather than alone or in other multiple bearing sets. Back-to-back and face-to-face bearing sets can be preloaded to adjust bearing rigidity. Extra light (EL), Light (L), Medium (M), and Heavy (H) are standard preloads. Friction torque for the bearing will increase in direct proportion to the preload.

The starting torque of angular contact ball bearings is mainly the torque caused by angular slippage between the balls and contact surfaces on the inner and outer rings. Starting torque for the bearing M due to such spin is given by,

$$M = M_s \cdot Z \sin \alpha \text{ (N-mm), {kgf-mm}} \dots\dots\dots(10.2)$$

where, M_s : Spin friction for contact angle α centered on the shaft,

$$M_s = \frac{3}{8} \mu_s \cdot Q \cdot a \cdot E \text{ (k)} \text{ (N-mm), {kgf-mm}}$$

- μ_s : Contact-surface slip friction coefficient
- Q : Load on rolling elements (N), {kgf}
- a : (1/2) of contact-ellipse major axis (mm)

$$E \text{ (k): With } k = \sqrt{1 - \left(\frac{b}{a}\right)^2}$$

as the population parameter, second class complete ellipsoidal integration

- b : (1/2) of contact-ellipse minor axis (mm)
- Z : Number of balls
- α : Contact angle ($^\circ$)

Actual measurements with 15° angular contact ball bearings correlate well with calculated results using $\mu_s = 0.15$ in Equation (10.2). Fig. 10.1 shows the calculated friction torque for 70C and 72C series bearings.

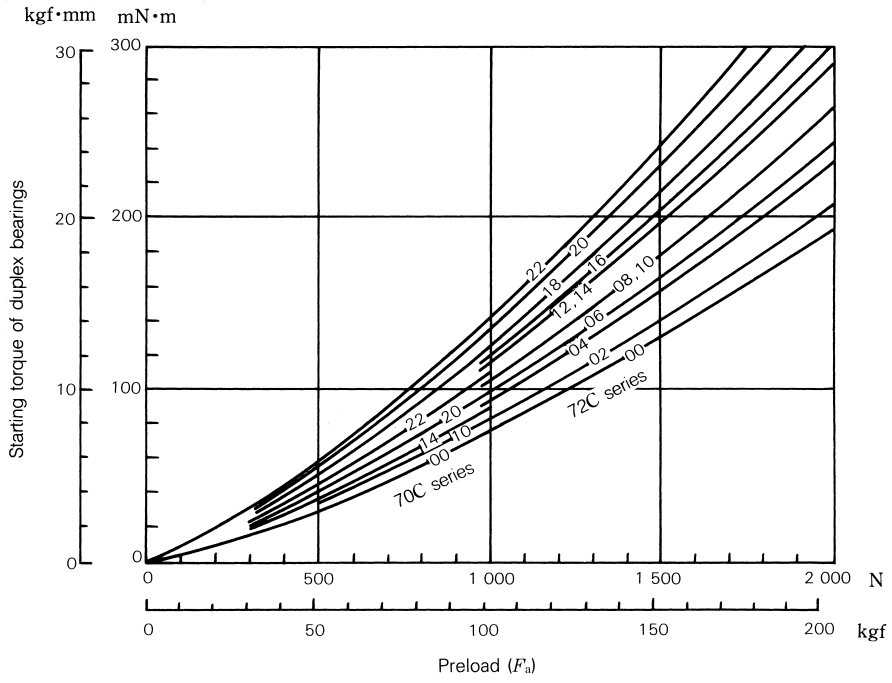

Fig. 10.1 Preload and Starting Torque for Angular Contact Ball Bearings ($\alpha=15^\circ$) of DF and DB Duplex Sets

Friction

10.3.2 Empirical Equation of Running Torque of High-Speed Ball Bearings

We present here empirical equations for the running torque of high speed ball bearings subject to axial loading and jet lubrication. These equations are based on the results of tests of angular contact ball bearings with bore diameters of 10 to 30 mm, but they can be extrapolated to bigger bearings. The running torque M can be obtained as the sum of a load term M_l and speed term M_v as follows:

$$M = M_l + M_v \text{ (N-mm), \{kgf-mm\}} \dots\dots\dots (10.3)$$

The load term M_l is the term for friction, which has no relation with speed or fluid friction, and is expressed by Equation (10.4) which is based on experiments.

$$\left. \begin{aligned} M_l &= 0.672 \times 10^{-3} D_{pw}^{0.7} F_a^{1.2} \text{ (N-mm)} \\ &= 1.06 \times 10^{-3} D_{pw}^{0.7} F_a^{1.2} \text{ \{kgf-mm\}} \end{aligned} \right\} \dots\dots\dots (10.4)$$

where, D_{pw} : Pitch diameter of rolling elements (mm)
 F_a : Axial load (N), {kgf}

The speed term M_v is that for fluid friction, which depends on angular speed, and is expressed by Equation (10.5).

$$\left. \begin{aligned} M_v &= 3.47 \times 10^{-10} D_{pw}^3 n_i^{1.4} Z_B^a Q^b \text{ (N-mm)} \\ &= 3.54 \times 10^{-11} D_{pw}^3 n_i^{1.4} Z_B^a Q^b \text{ \{kgf-mm\}} \end{aligned} \right\} \dots\dots\dots (10.5)$$

where, n_i : Inner ring speed (min⁻¹)
 Z_B : Absolute viscosity of oil at outer ring temperature (mPa·s), {cp}
 Q : Oil flow rate (kg/min)

The exponents a and b , that affect the oil viscosity and flow rate factors, depend only on the angular speed and are given by Equations (10.6) and (10.7) as follows:

$$\begin{aligned} a &= 24n_i^{-0.37} \dots\dots\dots (10.6) \\ b &= 4 \times 10^{-9} n_i^{1.6} + 0.03 \dots\dots\dots (10.7) \end{aligned}$$

An example of the estimation of the running torque of high speed ball bearings is shown in Fig. 10.2. A comparison of values calculated using these equations and actual measurements is shown in Fig. 10.3. When the contact angle exceeds 30°, the influence of spin friction becomes big, so the running torque given by the equations will be low.

Calculation Example

Obtain the running torque of high speed angular contact ball bearing 20BNT02 (φ20 × φ47 × 14) under the following conditions:

- $n_i = 70\,000 \text{ min}^{-1}$
- $F_a = 590 \text{ N}$, {60 kgf}
- Lubrication: Jet, oil viscosity: 10 mPa·s {10 cp}
- oil flow: 1.5 kg/min

From Equation (10.4),

$$\begin{aligned} M_l &= 0.672 \times 10^{-3} D_{pw}^{0.7} F_a^{1.2} \\ &= 0.672 \times 10^{-3} \times 33.5^{0.7} \times 590^{1.2} \\ &= 16.6 \text{ (N-mm)} \\ M_l &= 1.06 \times 10^{-3} \times 33.5^{0.7} \times 60^{1.2} \\ &= 1.7 \text{ \{kgf-mm\}} \end{aligned}$$

From Equations (10.6) and (10.7),

$$\begin{aligned} a &= 24n_i^{-0.37} \\ &= 24 \times 70\,000^{-0.37} = 0.39 \\ b &= 4 \times 10^{-9} n_i^{1.6} + 0.03 \\ &= 4 \times 10^{-9} \times 70\,000^{1.6} + 0.03 = 0.26 \end{aligned}$$

From Equation (10.5),

$$\begin{aligned} M_v &= 3.47 \times 10^{-10} D_{pw}^3 n_i^{1.4} Z_B^a Q^b \\ &= 3.47 \times 10^{-10} \times 33.5^3 \times 70\,000^{1.4} \times 10^{0.39} \times 1.5^{0.26} \\ &= 216 \text{ (N-mm)} \\ M_v &= 3.54 \times 10^{-11} \times 33.5^3 \times 70\,000^{1.4} \times 10^{0.39} \times 1.5^{0.26} \\ &= 22.0 \text{ \{kgf-mm\}} \end{aligned}$$

$$\begin{aligned} M &= M_l + M_v = 16.6 + 216 = 232.6 \text{ (N-mm)} \\ M &= M_l + M_v = 1.7 + 22 = 23.7 \text{ \{kgf-mm\}} \end{aligned}$$

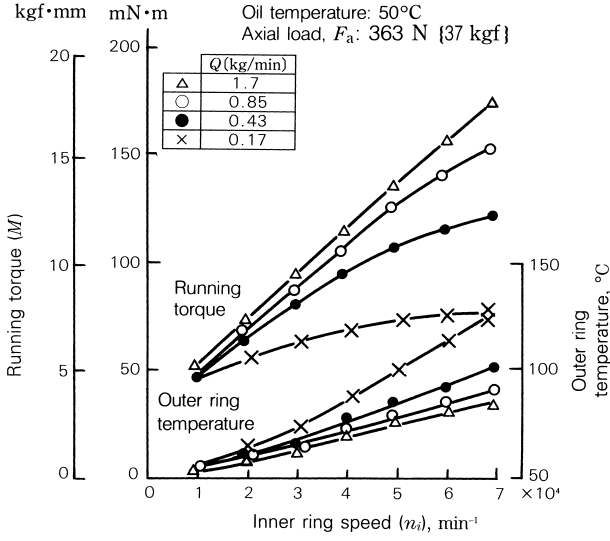

Fig. 10.2 Typical Test Example

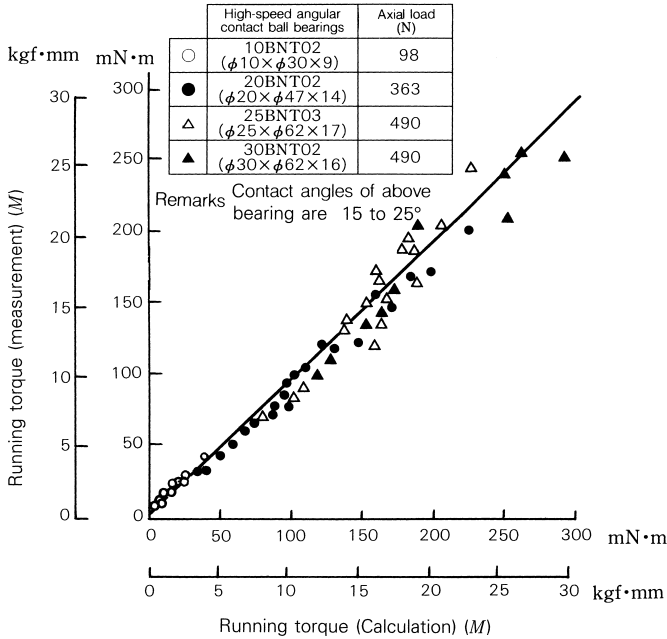

Fig. 10.3 Comparison of Actual Measurements and Calculated Values

Friction

10.3.3 Preload and Starting Torque for Tapered Roller Bearings

The balance of loads on the bearing rollers when a tapered roller bearing is subjected to axial load F_a is expressed by the following three Equations (10.8), (10.9), and (10.10):

$$Q_e = \frac{F_a}{Z \sin \alpha} \dots\dots\dots (10.8)$$

$$Q_i = Q_e \cos 2\beta = \frac{\cos 2\beta}{Z \sin \alpha} F_a \dots\dots\dots (10.9)$$

$$Q_f = Q_e \sin 2\beta = \frac{\sin 2\beta}{Z \sin \alpha} F_a \dots\dots\dots (10.10)$$

- where, Q_e : Rolling element load on outer ring (N), {kgf}
 Q_i : Rolling element load on inner ring (N), {kgf}
 Q_f : Rolling element load on inner-ring large end rib, (N), {kgf} (assume $Q_f \perp Q_i$)
 Z : Number of rollers
 α : Contact angle...(1/2) of the cup angle ($^\circ$)
 β : (1/2) of tapered roller angle ($^\circ$)
 D_{w1} : Roller large-end diameter (mm) (Fig. 10.4)
 e : Contact point between roller end and rib (Fig. 10.4)

As represented in Fig. 10.4, when circumferential load F is applied to the bearing outer ring and the roller turns in the direction of the applied load, the starting torque for contact point C relative to instantaneous center A becomes $\mu_e Q_f$.

Therefore, the balance of frictional torque is,

$$D_{w1}F = e \mu_e Q_f \text{ (N}\cdot\text{mm)}, \text{ {kgf}\cdot\text{mm}} \dots\dots\dots (10.11)$$

where, μ_e : Friction coefficient between inner ring large rib and roller endface

The starting torque M for one bearing is given by,

$$M = F Z l = \frac{e \mu_e l \sin 2\beta}{D_{w1} \sin \alpha} F_a \text{ (N}\cdot\text{mm)}, \text{ {kgf}\cdot\text{mm}} \dots\dots\dots (10.12)$$

because, $D_{w1} = 2 \overline{OB} \sin \beta$, and $l = \overline{OB} \sin \alpha$.

If we substitute these into Equation (10.12) we obtain,
 $M = e \mu_e \cos \beta F_a \text{ (N}\cdot\text{mm)}, \text{ {kgf}\cdot\text{mm}} \dots\dots\dots (10.13)$

The starting torque M is sought considering only the slip friction between the roller end and the inner-ring large-end rib. However, when the load on a tapered roller bearing reaches or exceeds a certain level (around the preload) the slip friction in the space between the roller end and inner-ring large end rib becomes the decisive factor for bearing starting torque. The torque caused by other factors can be ignored. Values for e and β in Equation (10.12) are determined by the bearing design. Consequently, assuming a value for μ_e , the starting torque can be calculated. The values for μ_e and for e have to be thought of as a dispersion, thus, even for bearings with the same number, the individual starting torques can be quite diverse. When using a value for e determined by the bearing design, the average value for the bearing starting torque can be estimated using $\mu_e = 0.20$ which is the average value determined from various test results. Fig. 10.5 shows the results of calculations for various tapered roller bearing series.

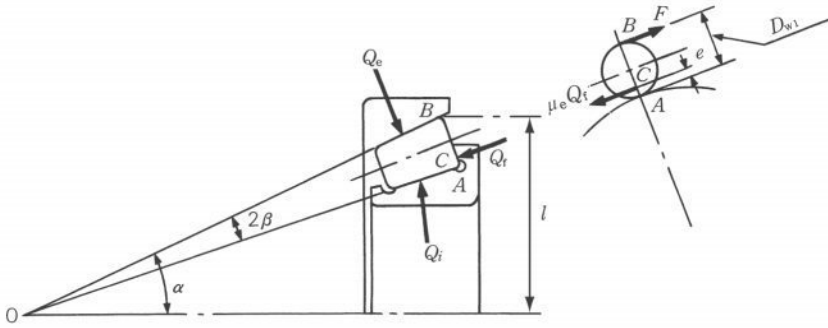

Fig. 10.4

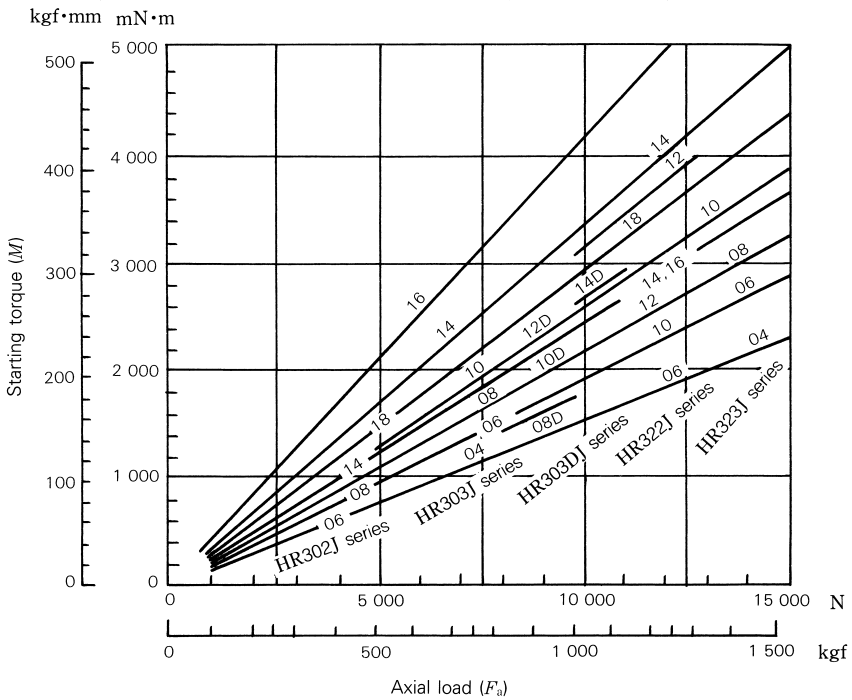

Fig. 10.5 Axial Load and Starting Torque for Tapered Roller Bearings

Friction

10.3.4 Empirical Equations for Running Torque of Tapered Roller Bearings

When tapered roller bearings operate under axial load, we reanalyzed the torque of tapered roller bearings based on the following two kinds of resistance, which are the major components of friction:

(1) Rolling resistance (friction) of rollers with outer or inner ring raceways — elastic hysteresis and viscous rolling resistance of EHL

(2) Sliding friction between inner ring ribs and roller ends
When an axial load F_a is applied on tapered roller bearings, the loads shown in Fig. 10.6 are applied on the rollers.

$$Q_e + Q_i = \frac{F_a}{Z \sin \alpha} \dots\dots\dots (10.14)$$

$$Q_i = \frac{F_a \sin 2\beta}{Z \sin \alpha} \dots\dots\dots (10.15)$$

- where, Q_e : Rolling element load on outer ring
 Q_i : Rolling element load on inner ring
 Q_f : Rolling element load on inner-ring large end rib
 Z : Number of rollers
 α : Contact angle...(1/2) of the cup angle
 β : (1/2) of tapered roller angle

For simplification, a model using the average diameter D_{we} as shown in Fig. 10.7 can be used.

- where, M_r, M_e : Rolling resistance (moment)
 F_{sr}, F_{ser}, F_{sf} : Sliding friction
 R_r, R_e : Radii at center of inner and outer ring raceways
 e : Contact height of roller end face with rib

In Fig. 10.7, when the balance of sliding friction and moments on the rollers are considered, the following equations are obtained:

$$F_{se} - F_{si} = F_{sf} \dots\dots\dots (10.16)$$

$$M_i + M_e = \frac{D_w}{2} F_{se} + \frac{D_w}{2} F_{si} + \left(\frac{D_w}{2} - e \right) F_{sf} \dots\dots\dots (10.17)$$

When the running torque M applied on the outer (inner) ring is calculated using Equations (10.16) and (10.17) and multiplying by Z , which is the number of rollers:

$$\begin{aligned} M &= Z (R_e F_{se} - M_e) \\ &= \frac{Z}{D_w} (R_e M_i + R_i M_e) + \frac{Z}{D_w} R_e e F_{sf} \\ &= M_R + M_S \end{aligned}$$

Therefore, the friction on the raceway surface M_R and that on the ribs M_S are separately obtained. Additionally, M_R and M_S are rolling friction and sliding friction respectively.

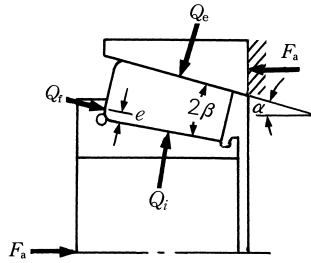

Fig. 10.6 Loads Applied on Roller

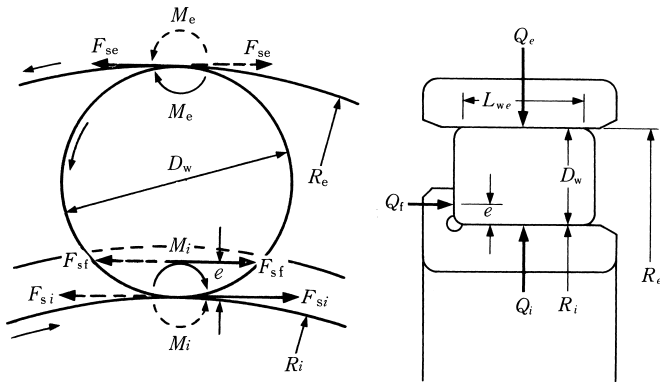

Fig. 10.7 Model of Parts where Friction is Generated

Friction

The running torque M of a tapered roller bearing can be obtained from the rolling friction on the raceway M_R and sliding friction on the ribs M_S .

$$M = M_R + M_S = \frac{Z}{D_w} (R_e M_i + R_o M_e) + \frac{Z}{D_w} R_e e F_{sf} \dots\dots\dots (10.18)$$

Sliding Friction on Rib M_S

As a part of M_S , F_{sf} is the tangential load caused by sliding, so we can write $F_{sf} = \mu Q_t$ using the coefficient of dynamic friction μ . Further, by substitution of the axial load F_a , the following equation is obtained:

$$M_S = e \mu \cos \beta F_a \dots\dots\dots (10.19)$$

This is the same as the equation for starting torque, but μ is not constant and it decreases depending on the conditions or running in. For this reason, Equation (10.19) can be rewritten as follows:

$$M_S = e \mu_0 \cos \beta F_a f' (A, t, \sigma) \dots\dots\dots (10.20)$$

Where μ_0 is approximately 0.2 and $f' (A, t, \sigma)$ is a function which decreases with running in and oil film formation, but it is set equal to one when starting.

Rolling Friction on Raceway Surface M_R

Most of the rolling friction on the raceway is viscous oil resistance (EHL rolling resistance). M_i and M_e in Equation (10.18) correspond to it. A theoretical equation exists, but it should be corrected as a result of experiments. We obtained the following equation that includes corrective terms:

$$M_{i, e} = \left[f(w) \left(\frac{1}{1 + 0.29L^{0.78}} \right) \frac{4.318}{\alpha_0} (G \cdot U)^{0.658} W^{0.0126} R^2 L_{we} \right]_{i, e} \dots\dots\dots (10.21)$$

$$f(w) = \left(\frac{kF_a}{E' D_w L_{we} Z \sin \alpha} \right)^{0.3} \dots\dots\dots (10.22)$$

Therefore, M_R can be obtained using Equations (10.21) and (10.22) together with the following equation:

$$M_R = \frac{Z}{D_w} (R_e M_i + R_o M_e)$$

Running Torque of Bearings M

From these, the running torque of tapered roller bearings M is given by Equation (10.23)

$$M = \frac{Z}{D_w} (R_e M_i + R_o M_e) + e \mu_0 \cos \beta F_a f' (A, t, \sigma) \dots\dots\dots (10.23)$$

As shown in Figs. 10.8 and 10.9, the values obtained using Equation (10.23) correlate rather well with actual measurements. Therefore, estimation of running torque with good accuracy is possible. When needed, please consult NSK.

[Explanation of Symbols]

- G, W, U: EHL dimensionless parameters
- L: Coefficient of thermal load
- α_0 : Pressure coefficient of lubricating oil viscosity
- R: Equivalent radius
- k: Constant
- E' : Equivalent elastic modulus
- α : Contact angle (Half of cup angle)
- R_i, R_e : Inner and outer ring raceway radii (center)
- β : Half angle of roller
- i, e: Indicate inner ring or outer ring respectively
- L_{we} : Effective roller length

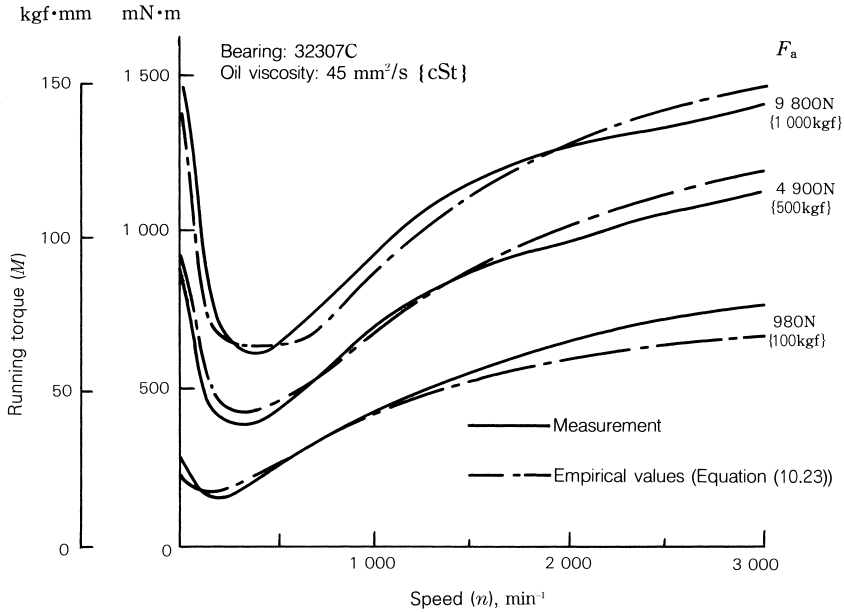

Fig. 10.8 Comparison of Empirical Values with Actual Measurements

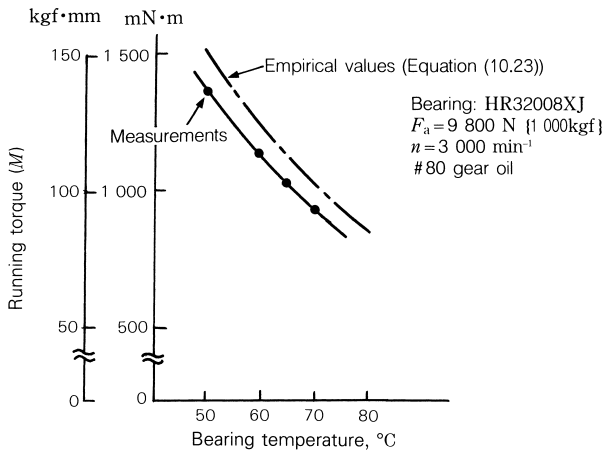

Fig. 10.9 Viscosity Variation and Running Torque



11. LUBRICATION

11.1	Purposes of Lubrication	A 228
11.2	Lubricating Methods	A 228
11.2.1	Grease Lubrication	A 228
(1)	Grease Quantity	A 228
(2)	Replacement of Grease	A 229
(3)	Replenishing Interval	A 229
(4)	Grease Life of Sealed Ball Bearings	A 231
11.2.2	Oil Lubrication	A 232
(1)	Oil Bath Lubrication	A 232
(2)	Drip-Feed Lubrication	A 232
(3)	Splash Lubrication	A 232
(4)	Circulating Lubrication	A 233
(5)	Jet Lubrication	A 234
(6)	Oil Mist Lubrication	A 235
(7)	Oil/Air Lubricating Method	A 235
11.3	Lubricants	A 236
11.3.1	Lubricating Grease	A 236
(1)	Base Oil	A 236
(2)	Thickener	A 236
(3)	Additives	A 236
(4)	Consistency	A 236
(5)	Mixing Different Types of Grease	A 238
11.3.2	Lubricating Oil	A 238
11.4	Technical Data	A 240
11.4.1	Brands and Properties of Lubricating Greases	A 240

11. Lubrication

11.1 Purposes of Lubrication

The main purposes of lubrication are to reduce friction and wear inside the bearings that may cause premature failure. The effects of lubrication may be briefly explained as follows:

(1) Reduction of Friction and Wear

Direct metallic contact between the bearing rings, rolling elements and cage, which are the basic components of a bearing, is prevented by an oil film which reduces the friction and wear in the contact areas.

(2) Extension of Fatigue Life

The rolling fatigue life of bearings depends greatly upon the viscosity and film thickness between the rolling contact surfaces. A heavy film thickness prolongs the fatigue life, but it is shortened if the viscosity of the oil is too low so the film thickness is insufficient.

(3) Dissipation of Frictional Heat and Cooling

Circulation lubrication may be used to carry away frictional heat or heat transferred from the outside to prevent the bearing from overheating and the oil from deteriorating.

(4) Others

Adequate lubrication also helps to prevent foreign material from entering the bearings and guards against corrosion or rusting.

11.2 Lubricating Methods

The various lubricating methods are first divided into either grease or oil lubrication. Satisfactory bearing performance can be achieved by adopting the lubricating method which is most suitable for the particular application and operating condition.

In general, oil offers superior lubrication; however, grease lubrication allows a simpler structure around the bearings. A comparison of grease and oil lubrication is given in Table 11.1.

Table 11.1 Comparison of Grease and Oil Lubrication

Item	Grease Lubrication	Oil Lubrication
Housing Structure and Sealing Method	Simple	May be complex. Careful maintenance required.
Speed	Limiting speed is 65% to 80% of that with oil lubrication	Higher limiting speed.
Cooling Effect	Poor	Heat transfer is possible using forced oil circulation.
Fluidity	Poor	Good
Full Lubricant Replacement	Sometimes difficult	Easy
Removal of Foreign Matter	Removal of particles from grease is impossible	Easy
External Contamination due to Leakage	Surroundings seldom contaminated by leakage	Often leaks without proper countermeasures. Not suitable if external contamination must be avoided.

11.2.1 Grease Lubrication

(1) Grease Quantity

The quantity of grease to be packed in a housing depends on the housing design and free space, grease characteristics, and ambient temperature. For example, the bearings for the main shafts of machine tools, where the accuracy may be impaired by a small temperature rise, require only a small amount of grease. The quantity of grease for ordinary bearings is determined as follows.

Sufficient grease must be packed inside the bearing including the cage guide face. The available space inside the housing to be packed with grease depends on the speed as follows:

1/2 to 2/3 of the space ... When the speed is less than 50% of the limiting speed.

1/3 to 1/2 of the space ... When the speed is more than 50% of the limiting speed.

(2) Replacement of Grease

Grease, once packed, usually does not need to be replenished for a long time; however, for severe operating conditions, grease should be frequently replenished or replaced. In such cases, the bearing housing should be designed to facilitate grease replenishment and replacement. When replenishment intervals are short, provide replenishment and discharge ports at appropriate positions so deteriorated grease is replaced by fresh grease. For example, the housing space on the grease supply side can be divided into several sections with partitions. The grease on the partitioned side gradually passes through the bearings and old grease forced from the bearing is discharged through a grease valve (Fig. 11.1). If a grease valve is not used, the space on

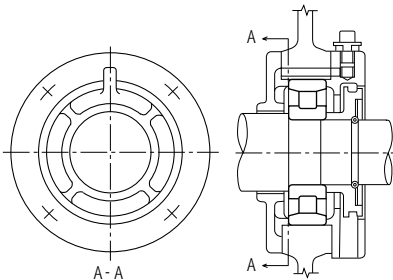

Fig. 11.1 Combination of Partitioned Grease Reservoir and Grease Valve

the discharge side is made larger than the partitioned side so it can retain the old grease, which is removed periodically by removing the cover.

(3) Replenishing Interval

Even if high-quality grease is used, there is deterioration of its properties with time; therefore, periodic replenishment is required. Figs. 11.2 (1) and (2) show the replenishment time intervals for various bearing types running at different speeds. Figs. 11.2 (1) and (2) apply for the condition of high-quality lithium soap-mineral oil grease, bearing temperature of 70 °C, and normal load ($P/C=0.1$).

> Temperature

If the bearing temperature exceeds 70 °C, the replenishment time interval must be reduced by half for every 15 °C temperature rise of the bearings.

> Grease

In case of ball bearings especially, the replenishing time interval can be extended depending on used grease type. (For example, high-quality lithium soap-synthetic oil grease may extend about two times of replenishing time interval shown in Fig. 11.2 (1). If the temperature of the bearings is less than 70 °C, the usage of lithium soap-mineral oil grease or lithium soap-synthetic oil grease is appropriate.) It is advisable to consult NSK.

> Load

The replenishing time interval depends on the magnitude of the bearing load.

Please refer to Fig. 11.2 (3).

If P/C exceeds 0.16, it is advisable to consult NSK.

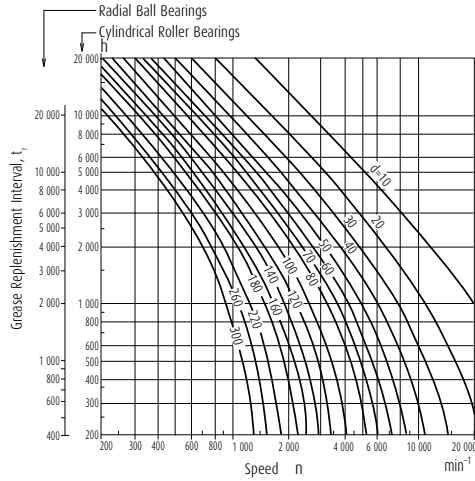

(1) Radial Ball Bearings, Cylindrical Roller Bearings

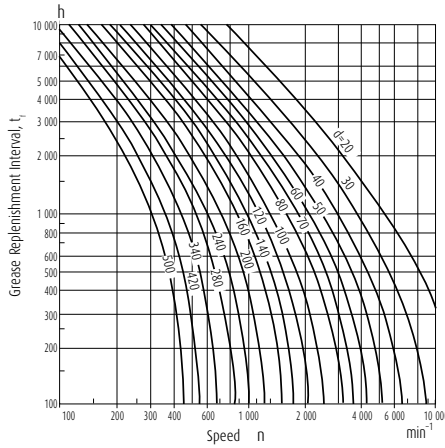

(2) Tapered Roller Bearings, Spherical Roller Bearings

(3) Load factor

P/C	0.06	0.1	0.13	0.16
Load factor	1.5	1	0.65	0.45

Fig. 11.2 Grease Replenishment Intervals

(4) Grease Life of Sealed Ball Bearings

When grease is packed into single-row deep groove ball bearings, the grease life may be estimated using Equation (11.1) or (11.2) or Fig. 11.3:

(General purpose grease (1))

$$\log t = 6.54 - 2.6 \frac{n}{N_{\max}} - \left(0.025 - 0.012 \frac{n}{N_{\max}}\right) T \quad \text{.....(11.1)}$$

(Wide-range grease (2))

$$\log t = 6.12 - 1.4 \frac{n}{N_{\max}} - \left(0.018 - 0.006 \frac{n}{N_{\max}}\right) T \quad \text{.....(11.2)}$$

- where t : Average grease life, (h)
 n : Speed (min⁻¹)
 N_{\max} : Limiting speed with grease lubrication (min⁻¹)
 (values for ZZ and VV types listed in the bearing tables)
 T : Operating temperature °C

Equations (11.1) and (11.2) and Fig. 11.3 apply under the following conditions:

(a) Speed, n

$$0.25 \leq \frac{n}{N_{\max}} \leq 1$$

when $\frac{n}{N_{\max}} < 0.25$, assume $\frac{n}{N_{\max}} = 0.25$

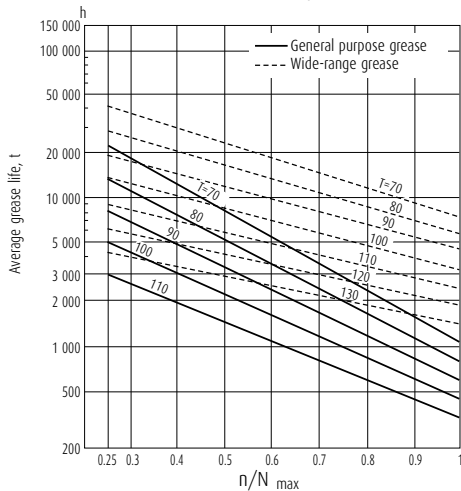

Fig. 11.3 Grease Life of Sealed Ball Bearings

(b) Operating Temperature, T

For general purpose grease (1)

$$70 \text{ °C} \leq T \leq 110 \text{ °C}$$

For wide-range grease (2)

$$70 \text{ °C} \leq T \leq 130 \text{ °C}$$

When $T < 70$ °C assume $T = 70$ °C

(c) Bearing Loads

The bearing loads should be about 1/10 or less of the basic load rating C_r .

Notes

- (1) Mineral-oil base greases (e.g. lithium soap base grease) which are often used over a temperature range of around -10 to 110 °C.
- (2) Synthetic-oil base greases are usable over a wide temperature range of around -40 to 130 °C.

Lubrication

11.2.2 Oil Lubrication

(1) Oil Bath Lubrication

Oil bath lubrication is a widely used with low or medium speeds. The oil level should be at the center of the lowest rolling element. It is desirable to provide a sight gauge so the proper oil level may be maintained (Fig. 11.4).

(2) Drip-Feed Lubrication

Drip feed lubrication is widely used for small ball bearings operated at relatively high speeds. As shown in Fig. 11.5, oil is stored in a visible oiler. The oil drip rate is controlled with the screw in the top.

(3) Splash Lubrication

With this lubricating method, oil is splashed onto the bearings by gears or a simple rotating disc installed near the bearings without submerging the bearings in oil.

This method is commonly used in automobile transmissions and final drive gears. Fig. 11.6 shows this lubricating method used on a reduction gear.

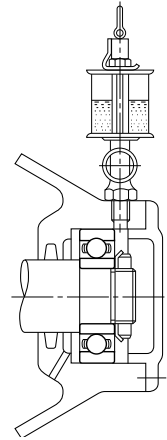

Fig. 11.5 Drip Feed Lubrication

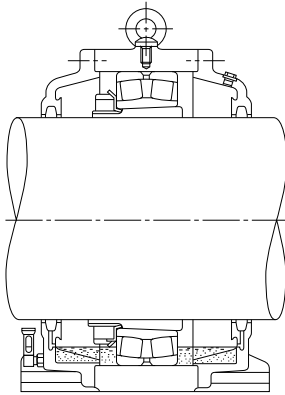

Fig. 11.4 Oil Bath Lubrication

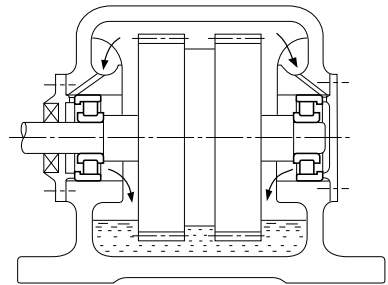

Fig. 11.6 Splash Lubrication

(4) Circulating Lubrication

Circulating lubrication is commonly used for high speed operation requiring bearing cooling and for bearings used at high temperatures. As shown in Fig. 11.7 (a), oil is supplied by the pipe on the right side, it travels through the bearing, and drains out through the pipe on the left. After being cooled in a reservoir, it returns to the bearing through a pump and filter.

The oil discharge pipe should be larger than the supply pipe so an excessive amount of oil will not back up in the housing.

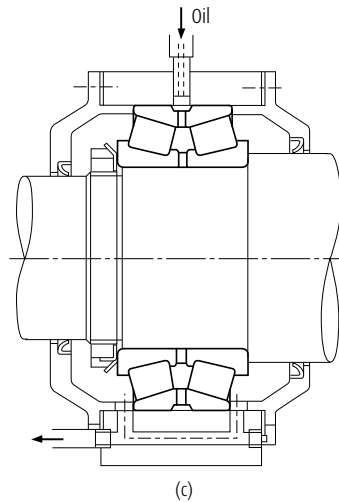
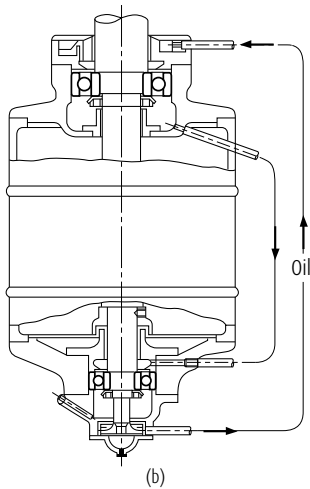
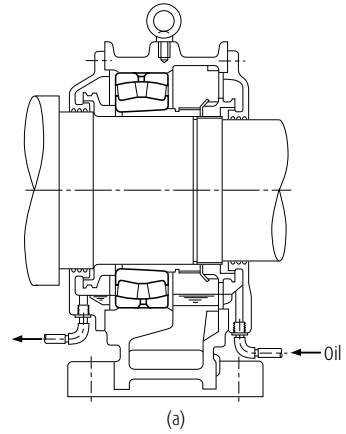

Fig. 11.7 Circulating Lubrication

Lubrication

(5) Jet lubrication

Jet lubrication is often used for ultra high speed bearings, such as the bearings in jet engines with a $d_m n$ value (d_m : pitch diameter of rolling element set in mm; n : rotational speed in min^{-1}) exceeding one million. Lubricating oil is sprayed under pressure from one or more nozzles directly into the bearing.

Fig. 11.8 shows an example of ordinary jet lubrication. The lubricating oil is sprayed on the inner ring and cage guide face. In the case of high speed operation, the air surrounding the bearing rotates with it causing the oil jet to be deflected. The jetting speed of the oil from the nozzle should be more than 20% of the circumferential speed of the inner ring outer surface (which is also the guide face for the cage).

More uniform cooling and a better temperature distribution is achieved using more nozzles for a given amount of oil. It is desirable for the oil to be forcibly discharged so the agitating resistance of the lubricant can be reduced and the oil can effectively carry away the heat.

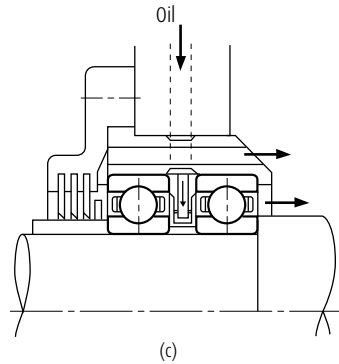
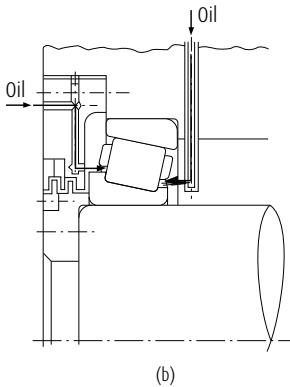
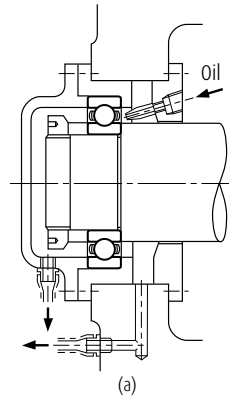

Fig. 11.8 Jet Lubrication

(6) Oil Mist Lubrication

Oil mist lubrication, also called oil fog lubrication, utilizes an oil mist sprayed into a bearing. This method has the following advantages:

- (a) Because of the small quantity of oil required, the oil agitation resistance is small, and higher speeds are possible.
- (b) Contamination of the vicinity around the bearing is slight because the oil leakage is small.
- (c) It is relatively easy to continuously supply fresh oil; therefore, the bearing life is extended.

This lubricating method is used in bearings for the high speed spindles of machine tools, high speed pumps, roll necks of rolling mills, etc (Fig. 11.9).

For oil mist lubrication of large bearings, it is advisable to consult NSK.

(7) Oil/Air Lubricating Method

Using the oil/air lubricating method, a very small amount of oil is discharged intermittently by a constant-quantity piston into a pipe carrying a constant flow of compressed air. The oil flows along the wall of the pipe and approaches a constant flow rate.

The major advantages of oil/air lubrication are:

- (a) Since the minimum necessary amount of oil is supplied, this method is suitable for high speeds because less heat is generated.
- (b) Since the minimum amount of oil is fed continuously, bearing temperature remains stable. Also, because of the small amount of oil, there is almost no atmospheric pollution.

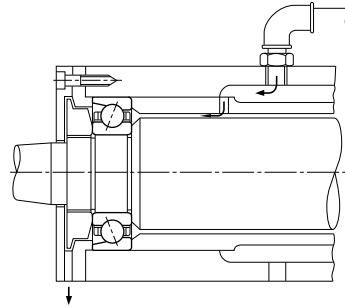

Fig. 11.9 Oil Mist Lubrication

(c) Since only fresh oil is fed to the bearings, oil deterioration need not be considered.

(d) Since compressed air is always fed to the bearings, the internal pressure is high, so dust, cutting fluid, etc. cannot enter.

For these reasons, this method is used in the main spindles of machine tools and other high speed applications (Fig. 11.10).

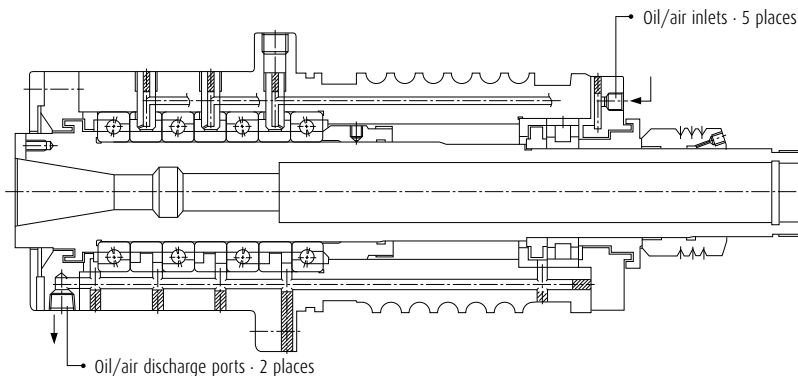

Fig. 11.10 Oil/Air Lubrication

11.3 Lubricants

11.3.1 Lubricating Grease

Grease is a semi-solid lubricant consisting of base oil, a thickener and additives. The main types and general properties of grease are shown in Table 11.2. It should be remembered that different brands of the same type of grease may have different properties.

(1) Base Oil

Mineral oils or synthetic oils such as silicone or diester oil are mainly used as the base oil for grease. The lubricating properties of grease depend mainly on the characteristics of its base oil. Therefore, the viscosity of the base oil is just as important when selecting grease as when selecting an oil. Usually, grease made with low viscosity base oils is more suitable for high speeds and low temperatures, while greases made with high viscosity base oils are more suited for high temperatures and heavy loads.

However, the thickener also influences the lubricating properties of grease; therefore, the selection criteria for grease is not the same as for lubricating oil. Moreover, please be aware that ester-based grease will cause acrylic rubber material to swell, and that silicone-based grease will cause silicone-based material to swell.

(2) Thickener

As thickeners for lubricating grease, there are several types of metallic soaps, inorganic thickeners such as silica gel and bentonite, and heat resisting organic thickeners such as polyurea and fluoric compounds.

The type of thickener is closely related to the grease dropping point (1); generally, grease with a high dropping point also has a high temperature capability during operation. However, this type of grease does not have a high working temperature unless the base oil is heat-resistant. The highest possible working temperature for grease should be determined considering the heat resistance of the base oil.

The water resistance of grease depends upon the type of thickener. Sodium soap grease or compound grease containing sodium soap emulsifies when exposed to water or high humidity, and therefore, cannot be used where moisture is prevalent. Moreover, please be aware that urea-based grease will cause fluorine-based material to deteriorate.

Note (1) The grease dropping point is that temperature at which a grease heated in a specified small container becomes sufficiently fluid to drip.

Table 11.2 Grease Properties

Properties	Lithium Grease		
	Li Soap		
	Mineral Oil	Diester Oil, Polyatomic Ester Oil	Silicone Oil
Dropping Point, °C	170 to 195	170 to 195	200 to 210
Working Temperatures, °C	-20 to +110	-50 to +130	-50 to +160
Working Speed, % ⁽¹⁾	70	100	60
Mechanical Stability	Good	Good	Good
Pressure Resistance	Fair	Fair	Poor
Water Resistance	Good	Good	Good
Rust Prevention	Good	Good	Poor
Remarks	General purpose grease used for numerous applications	Good low temperature and torque characteristics. Often used for small motors and instrument bearings. Pay attention to rust caused by insulation varnish.	Mainly for high temperature applications. Unsuitable for bearings for high and low speeds or heavy loads or those having numerous sliding-contact areas (roller bearings, etc.)

Note (1) The values listed are percentages of the limiting speeds given in the bearing tables.

(3) Additives

Grease often contains various additives such as antioxidants, corrosion inhibitors, and extreme pressure additives to give it special properties. It is recommended that extreme pressure additives be used in heavy load applications. For long use without replenishment, an antioxidant should be added.

(4) Consistency

Consistency indicates the "softness" of grease. Table 11.3 shows the relation between consistency and working conditions.

Sodium Grease (Fiber Grease)	Calcium Grease (Cup Grease)	Mixed Base Grease	Complex Base Grease (Complex Grease)	Non-Soap Base Grease (Non-Soap Grease)	
Na Soap	Ca Soap	Na + Ca Soap, Li + Ca Soap, etc.	Ca Complex Soap, Al Complex Soap, Li Complex Soap, etc.	Urea, Bentonite, Carbon Black, Fluoric Compounds, Heat Resistant Organic Compound, etc.	
Mineral Oil	Mineral Oil	Mineral Oil	Mineral Oil	Mineral Oil	Synthetic Oil (Ester Oil, Polyatomic Ester Oil, Synthetic Hydrocarbon Oil, Silicone Oil, Fluoric Based Oil)
170 to 210	70 to 90	160 to 190	180 to 300	> 230	> 230
-20 to +130	-20 to +60	-20 to +80	-20 to +130	-10 to +130	< +220
70	40	70	70	70	40 to 100
Good	Poor	Good	Good	Good	Good
Fair	Poor	Fair to Good	Fair to Good	Fair	Fair
Poor	Good	Poor for Na Soap Grease	Good	Good	Good
Poor to Good	Good	Fair to Good	Fair to Good	Fair to Good	Fair to Good
Long and short fiber types are available. Long fiber grease is unsuitable for high speeds. Attention to water and high temperature is required.	Extreme pressure grease containing high viscosity mineral oil and extreme pressure additive (Pb soap, etc.) has high pressure resistance.	Often used for roller bearings and large ball bearing.	Suitable for extreme pressures mechanically stable	Mineral oil base grease is middle and high temperature purpose lubricant. Synthetic oil base grease is recommended for low or high temperature. Some silicone and fluoric oil based grease have poor rust prevention and noise.	

Remark The grease properties shown here can vary between brands.

Table 11.3 Consistency and Working Conditions

Consistency Number	0	1	2	3	4
Consistency (1) 1/10 mm	355 to 385	310 to 340	265 to 295	220 to 250	175 to 205
Working Conditions (Application)	<ul style="list-style-type: none"> > For centralized oiling > When fretting is likely to occur 	<ul style="list-style-type: none"> > For centralized oiling > When fretting is likely to occur > For low temperatures 	<ul style="list-style-type: none"> > For general use > For sealed ball bearings 	<ul style="list-style-type: none"> > For general use > For sealed ball bearings > For high temperatures 	<ul style="list-style-type: none"> > For high temperatures > For grease seals

Note (1) Consistency: The depth to which a cone descends into grease when a specified weight is applied, indicated in units of 1/10 mm. The larger the value, the softer the grease.

Lubrication

(5) Mixing Different Types of Grease

In general, different brands of grease must not be mixed. Mixing grease with different types of thickeners may destroy its composition and physical properties. Even if the thickeners are of the same type, possible differences in the additive may cause detrimental effects.

11.3.2 Lubricating Oil

The lubricating oils used for rolling bearings are usually highly refined mineral oil or synthetic oil that have a high oil film strength and superior oxidation and corrosion resistance. When selecting a lubricating oil, the viscosity at the operating conditions is important. If the viscosity is too low, a proper oil film is not formed and abnormal wear and seizure may occur. On the other hand, if the viscosity is too high, excessive viscous resistance may cause heating or large power loss. In general, low viscosity oils should be used at high speed; however, the viscosity should increase with increasing bearing load and size.

Table 11.4 gives generally recommended viscosities for bearings under normal operating conditions.

For use when selecting the proper lubricating oil, Fig. 11.11 shows the relationship between oil temperature and viscosity, and examples of selection are shown in Table 11.5.

Table 11.4 Bearing Types and Proper Viscosity of Lubricating Oils

Bearing Type	Proper Viscosity at Operating Temperature
Ball Bearings and Cylindrical Roller Bearings	Higher than 13 mm ² /s
Tapered Roller Bearings and Spherical Roller Bearings	Higher than 20 mm ² /s
Spherical Thrust Roller Bearings	Higher than 32 mm ² /s

Remark 1mm²/s=1cSt (centistokes)

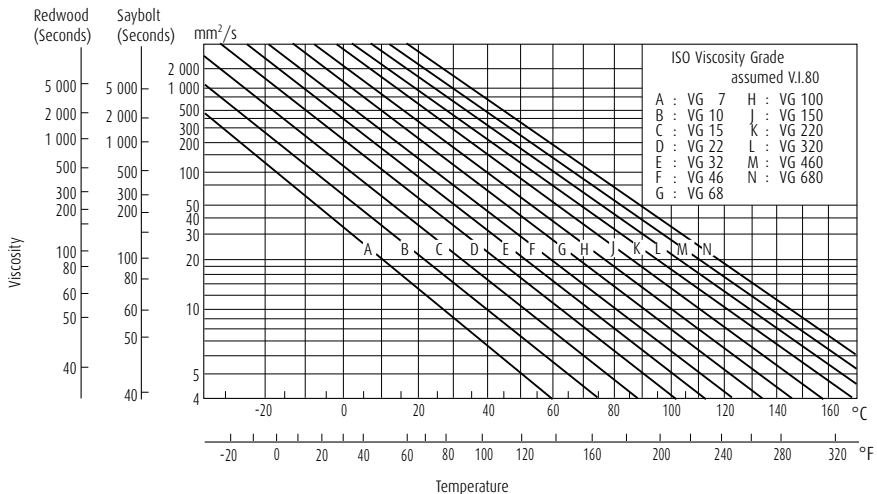

Fig. 11.11 Temperature-Viscosity Chart

Oil Replacement Intervals

Oil replacement intervals depend on the operating conditions and oil quantity.

In those cases where the operating temperature is less than 50 °C, and the environmental conditions are good with little dust, the oil should be replaced approximately once a year. However, in cases where the oil temperature is about 100 °C, the oil must be changed at least once every three months.

If moisture may enter or if foreign matter may be mixed in the oil, then the oil replacement interval must be shortened. Mixing different brands of oil must be prevented for the same reason given previously for grease.

Table 11.5 Examples of Selection Lubricating Oils

Operating Temperature	Speed	Light or normal Load	Heavy or Shock Load
-30 to 0 °C	Less than limiting speed	ISO VG 15, 22, 32 (refrigerating machine oil)	-
0 to 50 °C	Less than 50% of limiting speed	ISO VG 32, 46, 68 (bearing oil, turbine oil)	ISO VG 46, 68, 100 (bearing oil, turbine oil)
	50 to 100% of limiting speed	ISO VG 15, 22, 32 (bearing oil, turbine oil)	ISO VG 22, 32, 46 (bearing oil, turbine oil)
	More than limiting speed	ISO VG 10, 15, 22 (bearing oil)	-
50 to 80 °C	Less than 50% of limiting speed	ISO VG 100, 150, 220 (bearings oil)	ISO VG 150, 220, 320 (bearing oil)
	50 to 100% of limiting speed	ISO VG 46, 68, 100 (bearing oil, turbine oil)	ISO VG 68, 100, 150 (bearing oil, turbine oil)
	More than limiting speed	ISO VG 32, 46, 68 (bearing oil, turbine oil)	-
80 to 110 °C	Less than 50% of limiting speed	ISO VG 320, 460 (bearing oil)	ISO VG 460, 680 (bearing oil, gear oil)
	50 to 100% of limiting speed	ISO VG 150, 220 (bearing oil)	ISO VG 220, 320 (bearing oil)
	More than limiting speed	ISO VG 68, 100 (bearing oil, turbine oil)	-

Remarks

1. For the limiting speed, use the values listed in the bearing tables.
2. Refer to Refrigerating Machine Oils (JIS K 2211), Bearing Oils (JIS K 2239), Turbine Oils (JIS K 2213), Gear Oils (JIS K 2219).
3. If the operating temperature is near the high end of the temperature range listed in the left column, select a high viscosity oil.
4. If the operating temperature is lower than -30 °C or higher than 110 °C, it is advisable to consult NSK.

11.4 Technical Data

11.4.1 Brands and Properties of Lubricating Greases

Table 11.6 Brands of Lubricating Greases

Brands	NSK-Code	Thickeners	Base Oils
APOLLOIL AUTOLEX A	ALA	Lithium	Mineral oil
APAPEN RB320	R32	Lithium/Calcium	Mineral oil
EA2 GREASE	EA2	Urea (3)	Poly- α -olefin oil
EA3 GREASE	EA3	Urea (3)	Poly- α -olefin oil
EA5 GREASE	EA5	Urea (3)	Poly- α -olefin oil
EA7 GREASE	EA7	Urea (3)	Poly- α -olefin oil
ENC GREASE	ENC	Urea (3)	Polyol ester oil + Mineral oil (4)
ENS GREASE	ENS	Urea (3)	Polyol ester oil (4)
ECE GREASE	ECE	Lithium	Poly- α -olefin oil
ISOFLEX NBU 15	NB5	Barium Complex	Ester oil + Mineral oil
ISOFLEX SUPER LDS 18	DB5	Lithium	Ester oil (4)
ISOFLEX TOPAS NB 52	TN5	Barium Complex	Poly- α -olefin oil
MOLYKOTE SH33L GREASE	D3L	Lithium	Silicone oil (5)
MOLYKOTE SH44M GREASE	D4M	Lithium	Silicone oil (5)
NS HI-LUBE	NS7	Lithium	Polyol ester oil + Diester oil (4)
NSC GREASE	NSC	Lithium	Alkyldiphenyl ether oil + Polyol ester oil (4)
NSK CLEAN GREASE LG2	LG2	Lithium	Poly- α -olefin oil + Mineral oil
EMALUBE 8030	E80	Urea (3)	Mineral oil
MA8 GREASE	MA8	Urea (3)	Alkyldiphenyl ether oil + Poly- α -olefin oil
KRYTOX GPL-524	K24	PTFE	Perfluoropolyether oil
KP1 GREASE	KP1	PTFE	Perfluoropolyether oil
COSMO WIDE GREASE WR No.3N	WR3	Sodium Terephthalamate	Ester oil + Mineral oil
G-40M	G4M	Lithium	Silicone oil (5)
SHELL GADUS S2 V220 2	AP2	Lithium	Mineral oil
SHELL ALVANIA GREASE S2	AS2	Lithium	Mineral oil
SHELL ALVANIA GREASE S3	AS3	Lithium	Mineral oil
CASSIDA GREASE RLS 2	RLS	Aluminum Complex	Poly- α -olefin oil
SHELL SUNLIGHT GREASE 2	SL2	Lithium	Mineral oil
WPH GREASE	WPH	Urea (3)	Poly- α -olefin oil
DEMNUM GREASE L-200	DL2	PTFE	Perfluoropolyether oil
NIGLUB RSH	RSH	Sodium Complex	Polyalkylene Glycol oil
PALMAX RBG	PMK	Lithium Complex	Mineral oil
BEACON 325J	B3N	Lithium	Diester oil (4)
MULTEMP PS No.2	PS2	Lithium	Poly- α -olefin oil + Diester oil (4)
MOLYKOTE FS-3451 Grease	FS3	PTFE	Fluorosilicone oil (5)
UME GREASE	UME	Urea (3)	Mineral oil
RAREMAX AF-1	RA1	Urea (3)	Mineral oil

- Notes**
- (1) If grease will be used close to or outside the upper or lower limit of the temperature range or in a special environment such as vacuum, it is advisable to consult NSK.
 - (2) For short-term operation or when cooling is used grease may be used at speeds exceeding the above limits provided the supply of grease is appropriate.
 - (3) Urea-based grease can cause fluorine-based material to deteriorate.
 - (4) Ester-based grease can cause acrylic rubber material to swell.
 - (5) Silicone-based grease can cause silicone-based material to swell.

Dropping Point (°C)	Consistency	Working Temperature Range ⁽¹⁾ (°C)	Pressure Resistance	Usable Limit Compared to Listed Limiting Speed ⁽²⁾ (%)
198	280	-10 to +110	Fair	60
180	305	-10 to + 80	Fair	70
≥260	243	-40 to +150	Fair	100
≥260	230	-40 to +150	Fair	100
≥260	251	-40 to +160	Good	60
≥260	243	-40 to +160	Fair	100
≥260	262	-40 to +160	Fair	70
≥260	264	-40 to +160	Poor	100
≥260	235	-10 to +120	Poor	100
≥260	280	-20 to +120	Poor	100
195	280	-50 to +110	Poor	100
≥260	280	-40 to +130	Poor	90
210	310	-60 to +120	Poor	60
210	260	-30 to +130	Poor	60
192	250	-40 to +130	Poor	100
192	235	-30 to +140	Fair	70
201	199	-20 to +70	Poor	100
≥260	280	0 to +130	Good	60
≥260	273	-30 to +160	Fair	70
≥260	265	0 to +200	Fair	70
≥260	290	-30 to +200	Fair	60
≥230	227	-40 to +130	Poor	100
223	252	-30 to +130	Poor	60
187	276	0 to + 80	Good	60
181	275	-10 to +110	Fair	70
182	242	-10 to +110	Fair	70
≥240	280	0 to +120	Fair	70
200	274	-10 to +110	Fair	70
259	240	-40 to +150	Fair	70
≥260	280	-30 to +200	Fair	60
≥260	270	-20 to +140	Fair	60
216	300	-10 to +130	Good	70
190	278	-50 to +110	Poor	100
190	275	-50 to +110	Poor	100
≥260	285	0 to +180	Fair	70
≥260	272	-10 to +130	Fair	70
≥260	300	-10 to +130	Fair	70



12. BEARING MATERIALS

12.1	Materials for Bearing Rings and Rolling Elements	A 244
12.2	Cage Materials	A 245
12.3	Characteristics of Bearing and Shaft/Housing Materials	A 246
12.4	Technical Data	A 248
12.4.1	Comparison of National Standards of Rolling Bearing Steel	A 248
12.4.2	Long Life Bearing Steel (NSK Z Steel)	A 250
12.4.3	Dimensional Stability of Bearing Steel	A 252
12.4.4	Fatigue Analysis	A 254
(1)	Measurement of Fatigue Degree	A 254
(2)	Surface and Sub-Surface Fatigues	A 256
12.4.5	Hi-TF Bearings and Super-TF Bearings	A 258
(1)	Hi-TF Bearings, Super-TF Bearings, and TF Technology	A 258
(2)	TF Technology	A 258
(3)	Material Properties of Hi-TF Bearings and Super-TF Bearings	A 259
(4)	Service Life under Contaminated Lubrication Conditions	A 260
(5)	Service Life under Clean Lubrication Conditions	A 260
(6)	Service Life under Boundary Lubrication Conditions	A 261
(7)	Wear and Seizure Resistance	A 261
(8)	Heat Resistance	A 261
12.4.6	Physical Properties of Representative Polymers Used as Bearing Material	A 262
12.4.7	Characteristics of Nylon Material for Cages	A 264
12.4.8	Heat-Resistant Resin Materials for Cages	A 266

12. Bearing Materials

The bearing rings and rolling elements of rolling bearings are subjected to repetitive high pressure with a small amount of sliding. The cages are subjected to tension and compression and sliding contact with the rolling elements and either or both of the bearing rings.

Therefore, the materials used for the rings, rolling elements, and cages require the following characteristics:

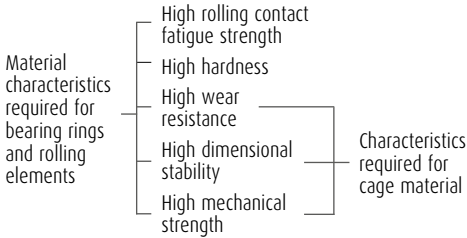

Other necessary characteristics, such as easy production, shock and heat resistance, and corrosion resistance, are required depending on individual applications.

12.1 Materials for Bearing Rings and Rolling Elements

Primarily, high carbon chromium bearing steel (Table 12.1) is used for the bearing rings and rolling elements. Most NSK bearings are made of SUJ2 among the JIS steel types listed in Table 12.1, while the larger bearings generally use SUJ3.

The chemical composition of SUJ2 is approximately the same as AISI 52100 specified in the USA, DIN 100 Cr6 in Germany, and BS 535A99 in UK.

For bearings that are subjected to very severe shock loads, carburized low-carbon alloy steels such as chrome steel, chrome molybdenum steel, nickel chrome molybdenum steel, etc. are often used. Such steels, when they are carburized to the proper depth and have sufficient surface hardness, are more shock resistant than normal, through-hardened bearing steels because of the softer energy-absorbing core. The chemical composition of common carburized bearing steels is listed in Table 12.2.

Table 12.1 Chemical Composition of High-Carbon Chromium Bearing Steel (Major Elements)

Standard	Symbols	Chemical Composition (%)						
		C	Si	Mn	P	S	Cr	Mo
JIS G 4805	SUJ 2	0.95 to 1.10	0.15 to 0.35	Less than 0.50	Less than 0.025	Less than 0.025	1.30 to 1.60	-
	SUJ 3	0.95 to 1.10	0.40 to 0.70	0.90 to 1.15	Less than 0.025	Less than 0.025	0.90 to 1.20	-
	SUJ 4	0.95 to 1.10	0.15 to 0.35	Less than 0.50	Less than 0.025	Less than 0.025	1.30 to 1.60	0.10 to 0.25
ASTM A 295	52100	0.93 to 1.05	0.15 to 0.35	0.25 to 0.45	Less than 0.025	Less than 0.015	1.35 to 1.60	Less than 0.10

Table 12.2 Chemical Composition of Carburizing Bearing Steels (Major Elements)

Standard	Symbols	Chemical Composition (%)							
		C	Si	Mn	P	S	Ni	Cr	Mo
JIS G 4052	SCR 420 H	0.17 to 0.23	0.15 to 0.35	0.55 to 0.95	Less than 0.030	Less than 0.030	Less than 0.25	0.85 to 1.25	-
	SCM 420 H	0.17 to 0.23	0.15 to 0.35	0.55 to 0.95	Less than 0.030	Less than 0.030	Less than 0.25	0.85 to 1.25	0.15 to 0.35
	SNCM 220 H	0.17 to 0.23	0.15 to 0.35	0.60 to 0.95	Less than 0.030	Less than 0.030	0.35 to 0.75	0.35 to 0.65	0.15 to 0.30
	SNCM 420 H	0.17 to 0.23	0.15 to 0.35	0.40 to 0.70	Less than 0.030	Less than 0.030	1.55 to 2.00	0.35 to 0.65	0.15 to 0.30
JIS G 4053	SNCM 815	0.12 to 0.18	0.15 to 0.35	0.30 to 0.60	Less than 0.030	Less than 0.030	4.00 to 4.50	0.70 to 1.00	0.15 to 0.30
ASTM A 534	8620 H	0.17 to 0.23	0.15 to 0.35	0.60 to 0.95	Less than 0.025	Less than 0.015	0.35 to 0.75	0.35 to 0.65	0.15 to 0.25
	4320 H	0.17 to 0.23	0.15 to 0.35	0.40 to 0.70	Less than 0.025	Less than 0.015	1.55 to 2.00	0.35 to 0.65	0.20 to 0.30
	9310 H	0.07 to 0.13	0.15 to 0.35	0.40 to 0.70	Less than 0.025	Less than 0.015	2.95 to 3.55	1.00 to 1.40	0.08 to 0.15

Table 12.3 Chemical Composition of High Speed Steel for Bearings Used at High Temperatures

Standard	Symbols	Chemical Composition (%)											
		C	Si	Mn	P	S	Cr	Mo	V	Ni	Cu	Co	W
AISI	M50	0.77 to 0.85	Less than 0.25	Less than 0.35	Less than 0.015	Less than 0.015	3.75 to 4.25	4.00 to 4.50	0.90 to 1.10	Less than 0.10	Less than 0.10	Less than 0.25	Less than 0.25

NSK uses highly pure vacuum-degassed bearing steel containing a minimum of oxygen, nitrogen, and hydrogen compound impurities. The rolling fatigue life of bearings has been remarkably improved using this material combined with the appropriate heat treatment.

For special purpose bearings, high temperature bearing steel, which has superior heat resistance, and stainless steel having good corrosion resistance may be used. The chemical composition of these special materials are given in Tables 12.3 and 12.4.

12.2 Cage Materials

The low carbon steels shown in Table 12.5 are the main ones for the pressed cages for bearings. Depending on the purpose, brass or stainless steel may be used. For machined cages, high strength brass (Table 12.6) or carbon steel (Table 12.5) is used. Sometimes synthetic resin is also used.

Table 12.4 Chemical Composition of Stainless Steel for Rolling Bearing (Major Elements)

Standard	Symbols	Chemical Composition (%)						
		C	Si	Mn	P	S	Cr	Mo
JIS G 4303	SUS 440 C	0.95 to 1.20	Less than 1.00	Less than 1.00	Less than 0.040	Less than 0.030	16.00 to 18.00	Less than 0.75
SAE J 405	51440 C	0.95 to 1.20	Less than 1.00	Less than 1.00	Less than 0.040	Less than 0.030	16.00 to 18.00	Less than 0.75

Table 12.5 Chemical Composition of Steel sheet and Carbon Steel for Cages (Major Elements)

Classification	Standard	Symbols	Chemical Composition (%)				
			C	Si	Mn	P	S
Steel sheet and strip for pressed cages	JIS G 3141	SPCC	Less than 0.12	–	Less than 0.50	Less than 0.04	Less than 0.045
	BAS 361	SPB 2	0.13 to 0.20	Less than 0.30	0.25 to 0.60	Less than 0.03	Less than 0.030
	JIS G 3311	S 50 CM	0.47 to 0.53	0.15 to 0.35	0.60 to 0.90	Less than 0.03	Less than 0.035
Carbon steel for machined cages	JIS G 4051	S 25 C	0.22 to 0.28	0.15 to 0.35	0.30 to 0.60	Less than 0.03	Less than 0.035

Remark BAS is Japanese Bearing Association Standard.

Table 12.6 Chemical Composition of High Strength Brass for Machined Cages

Standard	Symbols	Chemical Composition (%)								
		Cu	Zn	Mn	Fe	Al	Sn	Ni	Impurities	
									Pb	Si
JIS H 5120	CAC301 (HBSC 1)	55.0 to 60.0	33.0 to 42.0	0.1 to 1.5	0.5 to 1.5	0.5 to 1.5	Less than 1.0	Less than 1.0	Less than 0.4	Less than 0.1
JIS H 3250	C 6782	56.0 to 60.5	Residual	0.5 to 2.5	0.1 to 1.0	0.2 to 2.0	–	–	Less than 0.5	–

Remark Improved HBSC 1 is also used.

Bearing Materials

12.3 Characteristics of Bearing and Shaft/ Housing Materials

Rolling bearings must be able to resist high load, run at high speed, and endure long-time operation. It is also important to know the characteristics of the shaft and housing materials if the bearing performance is to be fully exploited. Physical and mechanical properties or typical materials of a bearing and shaft/housing are shown for reference in Table 12.7.

	Material	Heat treatment
Bearing	SUJ2	Quenching, tempering
	SUJ2	Spheroidizing annealing
	SCr420	Quenching, low temp tempering
	SAE4320 (SNCM420)	Quenching, low temp tempering
	SNCM815	Quenching, low temp tempering
	SUS440C	Quenching, low temp tempering
	SPCC	Annealing
	S25C	Annealing
Shaft	CAC301 (HBS C1)	—
	S45C	Quenching, 650°C tempering
	SCr430	Quenching, 520 to 620°C fast cooling
	SCr440	Quenching, 520 to 620°C fast cooling
	SCM420	Quenching, 150 to 200°C air cooling
	SNCM439	Quenching, 650°C tempering
	SC46	Normalizing
	SUS420J2	1 038°C oil cooling, 400°C air cooling
Housing	FC200	Casting
	FCD400	Casting
	A1100	Annealing
	AC4C	Casting
	ADC10	Casting
	SUS304	Annealing

Note * JIS standard or reference value.
 ** Though Rockwell C scale is generally

Remark Proportional limits of SUJ2 and SCr420

Table 12.7 Physical and Mechanical Properties of Bearing and Shaft/Housing Materials

	Density g/cm ³	Specific heat kJ/(kg·K)	Thermal conductivity W/(m·K)	Electric resistance μΩ·cm	Linear expansion coeff. (0 to 100°C) ×10 ⁻⁶ /°C	Young's modulus MPa {kgf/mm ² }	Yield point MPa (kgf/ mm ²)	Tensile strength MPa {kgf/mm ² }	Elongation %	Hardness HB	Remarks
	7.83	0.47	46	22	12.5	208 000 {21 200}	1 370 {140}	1 570 to 1 960 {160 to 200}	0.5 Max.	650 to 740	High carbon chrome bearing steel No. 2
	7.86							11.9	420 {43}	647 {66}	
	7.83		48	21	12.8		882 {90}	1 225 {125}	15	370	Chrome steel
			44	20	11.7		902 {92}	1 009 {103}	16	**293 to 375	Nickel chrome molybdenum steel
	7.89		40	35	—		—	*1 080 {110} Min.	*12 Min.	*311 to 375	
	7.68	0.46	24	60	10.1	200 000 {20 400}	1 860 {190}	1 960 {200}	—	**580	Martensitic stainless steel
	7.86	0.47	59	15	11.6	206 000 {21 000}	—	*275 {28} Min.	*32 Min.	—	Cold rolled steel plate
		0.48	50	17	11.8		323 {33}	431 {44}	33	120	Carbon steel for machine structure
	8.5	0.38	123	6.2	19.1	103 000 {10 500}	—	*431 {44} Min.	*20 Min.	—	High-tension brass
	7.83	0.48	47	18	12.8	207 000 {21 100}	440 {45}	735 {75}	25	217	Carbon steel for machine structure
				22	12.5	208 000 {21 100}	*637 {65} Min.	*784 {80} Min.	*18 Min.	*229 to 293	Chrome steel
			45	23			*784 {80} Min.	*930 {95} Min.	*13 Min.	*269 to 331	
		0.47	48	21	12.8	—	*930 {95} Min.	*14 Min.	*262 to 352	Chrome molybdenum steel	
			38	30	11.3	207 000 {21 100}	920 {94}	1 030 {105}	18	320	Nickel chrome molybdenum steel
	—	—	—	—	—	206 000 {21 100}	294 {30}	520 {53}	27	143	Low carbon cast steel
	7.75	0.46	22	55	10.4	200 000 {20 400}	1 440 {147}	1 650 {168}	10	400	Martensitic stainless steel
	7.3	0.50	43	—		98 000 {10 000}	—	*200 {20} Min.	—	*217 Max.	Gray cast iron
	7.0	0.48	20	—	11.7	169 000 {17 200}	*250 {26} Min.	*400 {41} Min.	*12 Min.	*201 Max.	Spheroidal graphite cast iron
	2.69	0.90	222	3.0	23.7	70 600 {7 200}	34 {3.5}	78 {8}	35	—	Pure aluminum
	2.68	0.88	151	4.2	21.5	72 000 {7 350}	88 {9}	167 {17}	7	—	Aluminum alloy for sand casting
	2.74	0.96	96	7.5	22.0	71 000 {7 240}	167 {17}	323 {33}	4	—	Aluminum alloy for die casting
	8.03	0.50	15	72	15.7 to 16.8	193 000 {19 700}	245 {25}	588 {60}	60	150	Austenitic stainless steel

used, Brinell hardness is shown for comparison.
are 833 MPa {85 kgf/mm²} and 440 MPa {45 kgf/mm²} respectively as reference.

Bearing Materials

12.4 Technical Data

12.4.1 Comparison of National Standards of Rolling Bearing Steel

The dimension series of rolling bearings as mechanical elements have been standardized internationally, and the material to be used for them specified in ISO 683/17 (heat treatment, alloy, and free cutting steels / Part 17 ball and roller bearing steels). However, materials are also standardized according to standards of individual countries and, in some cases, makers are even making their own modifications. As internationalization of products incorporating bearings and references to the standards of these kinds of steels are increasing nowadays, applicable standards are compared and their features described for some representative bearing steels.

JIS G 4805	ASTM	Other major national standards
SUJ2	—	—
—	A 295-89 52100	—
—	—	100Cr6 (DIN)
—	—	100C6 (NF)
—	—	535A99 (BS)
SUJ3	—	—
—	A 485-03 Grade 1	—
—	A 485-03 Grade 2	—
SUJ4	—	—
SUJ5	—	—
—	A 485-03 Grade 3	—

Note *1: P 0.025, S 0.025
Remark ASTM: Standard of American Society

JIS G 4052 G 4053	ASTM A 534-90	C
SCr420H	—	0.17 to 0.23
—	5120H	0.17 to 0.23
SCM420H	—	0.17 to 0.23
—	4118H	0.17 to 0.23
SNCM220H	—	0.17 to 0.23
—	8620H	0.17 to 0.23
SNCM420H	—	0.17 to 0.23
—	4320H	0.17 to 0.23
SNCM815	—	0.12 to 0.18
—	9310H	0.07 to 0.13

Note *2: P 0.030, S 0.030
 *3: P 0.025, S 0.015

Table 12.8 Applicable National Standards and Chemical Composition of High-Carbon Chrome Bearing Steel

	Chemical composition (%)						Application	Remarks
	C	Si	Mn	Cr	Mo	Others		
0.95 to 1.10	0.15 to 0.35	0.50	1.30 to 1.60	—	*1	Typical steel type for small and medium size bearings	Equivalent to each other though there are slight differences in the ranges.	
0.93 to 1.05	0.15 to 0.35	0.25 to 0.45	1.35 to 1.60	0.08	P 0.025 S 0.015			
0.90 to 1.05	0.15 to 0.35	0.25 to 0.40	1.40 to 1.65	—	—			
0.95 to 1.10	0.15 to 0.35	0.20 to 0.40	1.35 to 1.60	0.08	P 0.030 S 0.025			
0.95 to 1.10	0.10 to 0.35	0.40 to 0.70	1.20 to 1.60	—	*1			
0.95 to 1.10	0.40 to 0.70	0.90 to 1.15	0.90 to 1.20	—	*1	For large size bearings	SUJ3 is equivalent to Grade 1. Grade 2 has better quenching capability	
0.90 to 1.05	0.45 to 0.75	0.90 to 1.20	0.90 to 1.20	0.08	P 0.025 S 0.015			
0.85 to 1.00	0.50 to 0.80	1.40 to 1.70	1.40 to 1.80	0.10	P 0.025 S 0.015			
0.95 to 1.10	0.15 to 0.35	0.50	1.30 to 1.60	0.10 to 0.25	*1	Scarcely used	Better quenching capability than SUJ2	
0.95 to 1.10	0.40 to 0.70	0.90 to 1.15	0.90 to 1.20	0.10 to 0.25	*1	For ultralarge size bearings	Though Grade 3 is equivalent to SUJ5, quenching capability of Grade 3 is better than SUJ5.	
0.95 to 1.10	0.15 to 0.35	0.65 to 0.90	1.10 to 1.50	0.20 to 0.30	P 0.025 S 0.015			

of Testing Materials, DIN: German Standard, NF: French Standard, BS: British Standard

Table 12.9 JIS and ASTM Standards and Chemical Composition of Carburizing Bearing Steel

	Chemical composition (%)						Application	Remarks
	Si	Mn	Ni	Cr	Mo	Others		
0.15 to 0.35	0.55 to 0.95	0.25	0.85 to 1.25	—	*2	For small bearings	Similar steel type	
0.15 to 0.35	0.60 to 1.00	—	0.60 to 1.00	—	*3			
0.15 to 0.35	0.55 to 0.95	0.25	0.85 to 1.25	0.15 to 0.35	*2	For small bearings	Similar steel type, though quenching capability of 4118H is inferior to SCM420H	
0.15 to 0.35	0.60 to 1.00	—	0.30 to 0.70	0.08 to 0.15	*3			
0.15 to 0.35	0.60 to 0.95	0.35 to 0.75	0.35 to 0.65	0.15 to 0.30	*2	For small bearings	Equivalent, though there are slight differences	
0.15 to 0.35	0.60 to 0.95	0.35 to 0.75	0.35 to 0.65	0.15 to 0.25	*3			
0.15 to 0.35	0.40 to 0.70	1.55 to 2.00	0.35 to 0.65	0.15 to 0.30	*2	For medium bearings	Equivalent, though there are slight differences	
0.15 to 0.35	0.40 to 0.70	1.55 to 2.00	0.35 to 0.65	0.20 to 0.30	*3			
0.15 to 0.35	0.30 to 0.60	4.00 to 4.50	0.70 to 1.00	0.15 to 0.30	*2	For large bearings	Similar steel type	
0.15 to 0.35	0.40 to 0.70	2.95 to 3.55	1.00 to 1.45	0.08 to 0.15	*3			

Bearing Materials

12.4.2 Long Life Bearing Steel (NSK Z Steel)

It is well known that the rolling fatigue life of highcarbon chrome bearing steel (SUJ2, SAE52100) used for rolling bearings is greatly affected by non-metallic inclusions. Non-metallic inclusions are roughly divided into threetypes: sulfide, oxide, and nitride. The life test executed for long periods showed that oxide non-metallic inclusions exert a particularly adverse effect on the rolling fatigue life. Fig. 12.1 shows the parameter (oxygen content) indicating the amount of oxide non-metallic inclusions vs. life. The oxygen amount in steel was minimized as much as possible by reducing impurities (Ti, S) substantially, thereby achieving a decrease in the oxide non-metallic inclusions. The resulting long-life steel is the Z steel. The Z steel is an achievement of improved steelmaking facility and operating conditions made possible by cooperation with a steel maker on the basis of numerous life test data. A graph of the oxygen content in steel over the last 25 years is shown in Fig. 12.2.

The result of the life test with sample material in Fig. 12.2 is shown in Fig. 12.3. The life tends to become longer with decreasing oxygen content in steel. The high-quality Z steel has a life span which is about 1.8 times longer than that of conventional degassed steel.

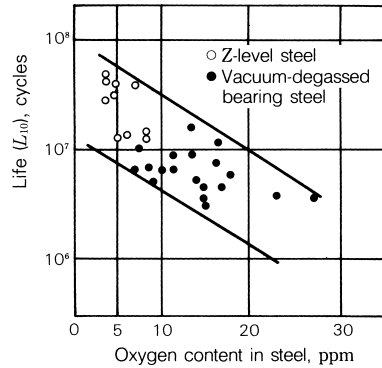

Fig. 12.1 Oxygen Content in Steel and Life of Bearing Steel

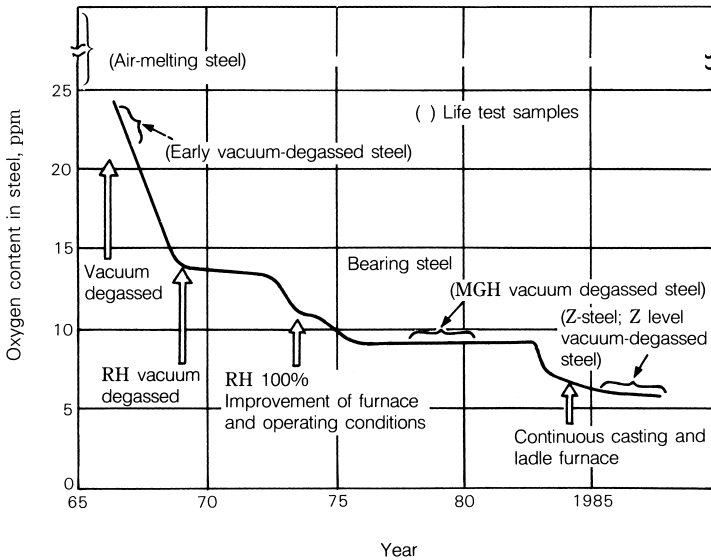
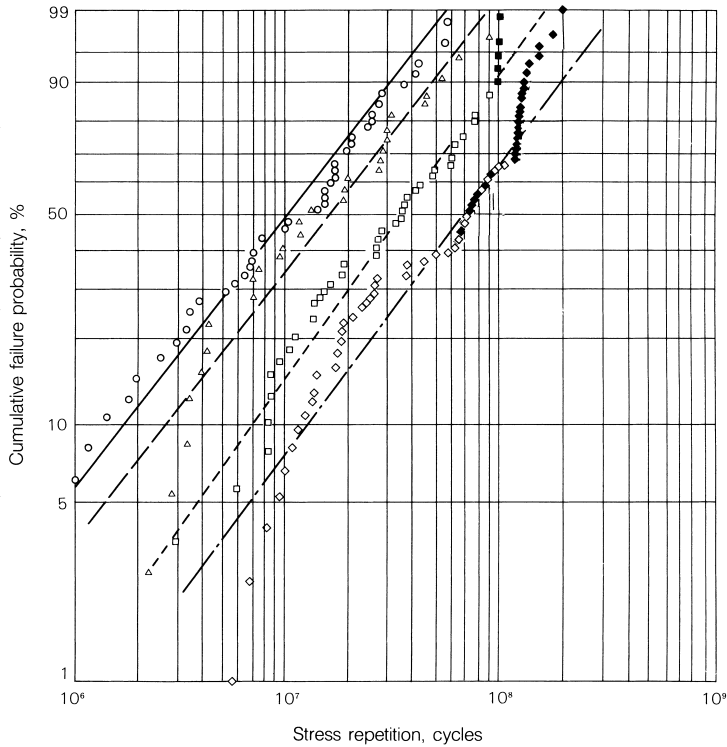

Fig. 12.2 Transition of Oxygen Content in NSK Bearing Steels



Classification	Test quantity	Failed quantity	Weibull slope	L_{10}	L_{50}
f Air-melting steel	44	44	1.02	1.67×10^6	1.06×10^7
b Vacuum degassed steel	30	30	1.10	2.82×10^6	1.55×10^7
c MGH vacuum degassed steel	46	41	1.16	6.92×10^6	3.47×10^7
e Z steel	70	39	1.11	1.26×10^7	6.89×10^7

Remark Testing of bearings marked dark C and E has not been finished testing yet.

Fig. 12.3 Result of Thrust Life Test of Bearing Steel

Bearing Materials

12.4.3 Dimensional Stability of Bearing Steel

Sectional changes or changes in the dimensions of rolling bearings as time passes during operation is called aging deformation. When the inner ring develops expansion due to such deformation, the result is a decrease in the interference between the shaft and inner ring. This becomes one of the causes of inner ring creep. Creep phenomenon, by which the shaft and inner ring slip mutually, causes the bearing to proceed from heat generation to seizure, resulting in critical damage to the entire machine. Consequently, appropriate measures must be taken against aging deformation of the bearing depending on the application.

Aging deformation of bearings may be attributed to secular thermal decomposition of retained austenite in steel after heat treatment. The bearing develops gradual expansion along with phase transformation.

The dimensional stability of the bearings, therefore, varies in accordance with the relative relationship between the tempering during heat treatment and the bearing's operating temperature. The bearing dimensional stability increases with rising tempering temperature while the retained austenite decomposition gradually expands as the bearing's operating temperature rises.

Fig. 12.4 shows how temperature influences the bearing's dimensional stability. In the right-hand portion of the figure, the interference between the inner ring and shaft in various shaft tolerance classes is shown as percentages for the shaft diameter. As is evident from Fig. 12.4, the bearing dimensional stability becomes more unfavorable as the bearing's temperature rises. Under these conditions, the interference between the shaft and inner ring of a general bearing is expected to decrease gradually. In this view, loosening of the fit surface needs to be prevented by using a bearing which has received dimension stabilization treatment.

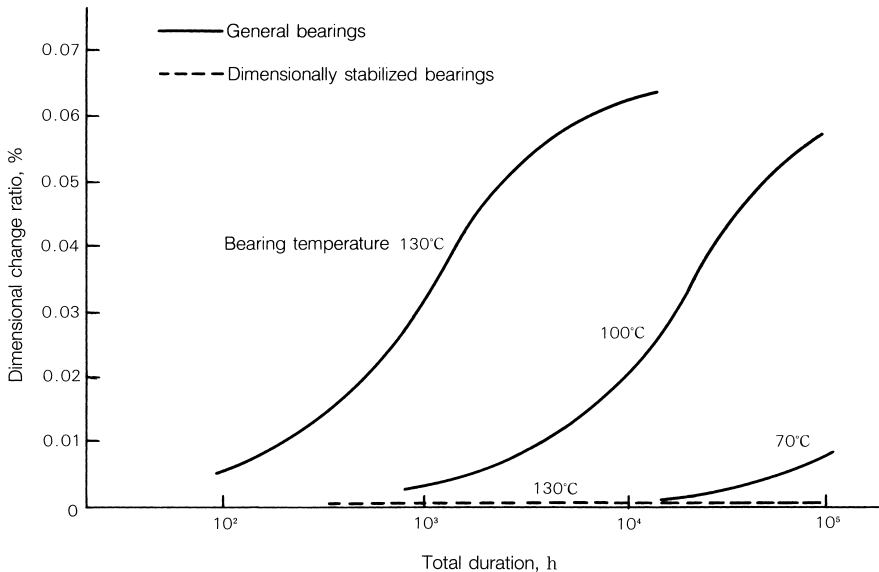
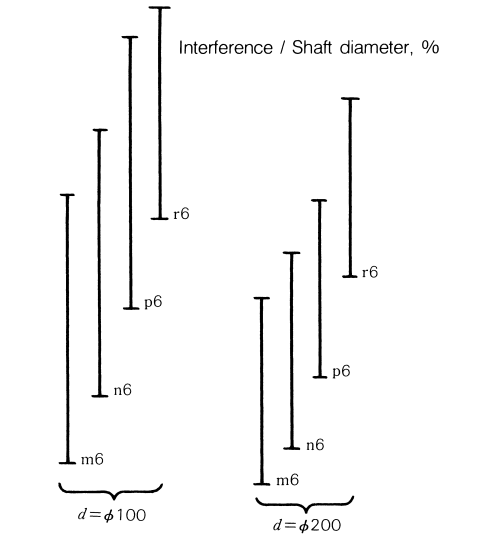

Fig. 12.4 Bearing Temperature and Dimensional Change Ratio

When the bearing temperature is high, there is a possibility of inner ring creep. Since due attention is necessary for selection of an appropriate bearing, it is essential to consult NSK beforehand.



12.4.4 Fatigue Analysis

It is necessary for prediction of the fatigue life of rolling bearings and estimation of the residual life to know all fatigue break-down phenomena of bearings. But, it will take some time before we reach a stage enabling prediction and estimation. Rolling fatigue, however, is fatigue proceeding under compressive stress at the contact point and known to develop extremely great material change until breakdown occurs. In many cases, it is possible to estimate the degree of fatigue of bearings by detecting material change. However, this estimation method is not effective in the cases where the defects in the raceway surface cause premature cracking or chemical corrosion occurs on the raceway. In these two cases, flaking grows in advance of the material change.

(1) Measurement of Fatigue Degree

The progress of fatigue in a bearing can be determined by using an X-ray to measure changes in the residual stress, diffraction half-value width, and retained austenite amount. These values change as the fatigue progresses as shown in Fig. 12.5. Residual stress, which grows early and approaches the saturation value, can be used to detect extremely small fatigue. For large fatigue, change of the diffraction half-value width and retained austenite amount may be correlated to the progress of fatigue. These measurements with X-ray are put together into one parameter (fatigue index) to determine the relationship with the endurance test period of a bearing. Measured values were collected by carrying out endurance test with many ball, tapered roller, and cylindrical roller bearings under various load and lubrication conditions. Simultaneously, measurements were made on bearings used in actual machines.

Fig. 12.6 summarizes the data. Variance is considerable because data reflects the complexity of the fatigue phenomenon. But, there exists correlation between the fatigue index and the endurance test period or operating hours. If some uncertainty is allowed, the fatigue degree can be handled quantitatively.

Description of "sub-surface fatigue" in Fig. 12.6 applies to the case when fatigue is governed by internal shearing stress. "Surface fatigue" shows correlation when the surface fatigue occurs earlier and more severely than sub-surface fatigue due to contamination or oil film breakdown of lubricating oil.

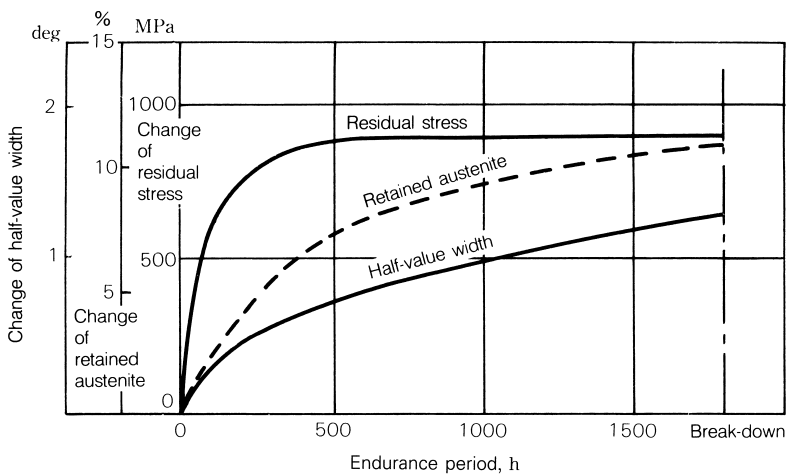

Fig. 12.5 Change in X-ray Measurements

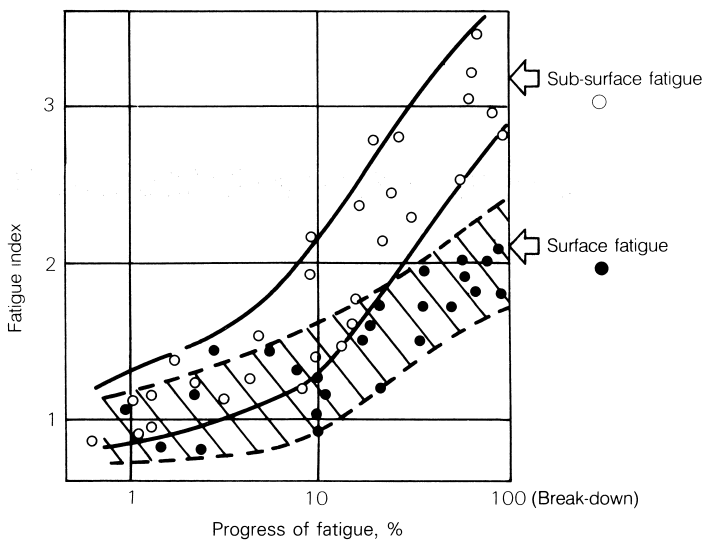

Fig. 12.6 Fatigue Progress and Fatigue Index

(2) Surface and Sub-Surface Fatigues

Rolling bearings have an extremely smooth finish surface and enjoy relatively satisfactory lubrication conditions. It has been considered that internal shearing stress below the rolling surface governs the failure of a bearing.

Shearing stress caused by rolling contact becomes maximum at a certain depth below the surface, with a crack (which is an origin of break-down) occurring initially under the surface. When the raceway is broken due to such sub-surface fatigue, the fatigue index as measured in the depth direction is known to increase according to the theoretical calculation of shearing stress, as is evident from an example of the ball bearing shown in Fig. 12.7.

The fatigue pattern shown in Fig. 12.7 occurs mostly when lubrication conditions are satisfactory and oil film of sufficient thickness is formed in rolling contact points. The basic dynamic load rating described in the bearing catalog is determined using data of bearing failures according to the above internal fatigue pattern. Fig. 12.8 shows an example of a cylindrical roller bearing subject to endurance test under lubrication conditions causing unsatisfactory oil film. It is evident that the surface fatigue degree rises much earlier than the calculated life.

In this test, all bearings failed before sub-surface fatigue became apparent. In this way, bearing failure due to surface fatigue is mostly attributed to lubrication conditions such as insufficient oil film due to excessively low oil viscosity or entry of foreign matters or moisture into lubricant.

Needless to say, bearing failure induced by surface fatigue occurs in advance of that by sub-surface fatigue. Bearings in many machines are exposed frequently to danger of initiating such surface fatigue and, in most of the cases, failure by surface fatigue prior to failure due to sub-surface fatigue (which is the original life limit of bearings).

Fatigue analysis of bearings used in actual machines shows not the sub-surface fatigue pattern, but the surface fatigue pattern as shown in the figure in overwhelmingly high percentage.

In this manner, knowing the distribution of the fatigue index in actually used bearings leads to an understanding of effective information not only on residual life of bearings, but also on lubrication and load conditions.

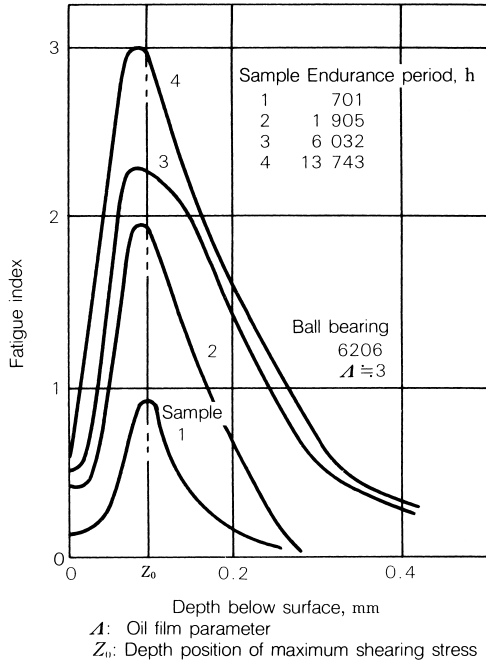

Fig. 12.7 Progress of Sub-Surface Fatigue

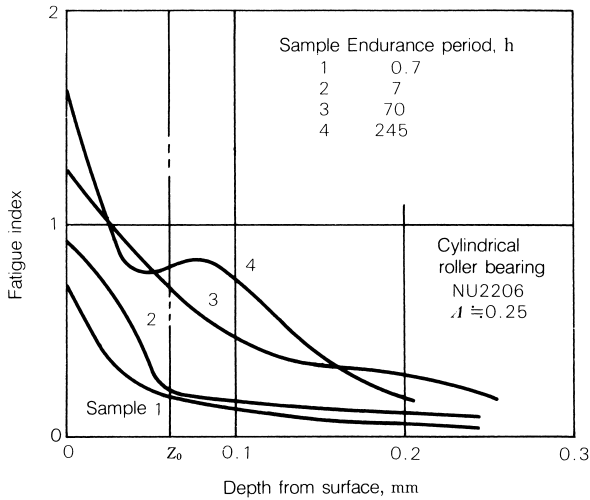

Fig. 12.8 Progress of Surface Fatigue

Bearing Materials

12.4.5 Hi-TF Bearings and Super-TF Bearings

(1) Hi-TF Bearings, Super-TF Bearings, and TF Technology

In its quest for longer bearing service life, NSK has spent many years analyzing the mechanisms of fatigue in bearings and researching and developing materials, heat treatment processes and operating conditions. The range of approaches to achieving longer service life taken by our research team are shown in Fig. 12.9. The technology incorporated in our Hi-TF Bearings and Super-TF Bearings is designed to maximize service life under conditions where bearings are subject to surface-originating flaking.

(2) TF Technology

Bearings may be required to operate under clean or dirty conditions; under dirty conditions their lubricating oil is easily contaminated. Metal particles or casting sand in the lubricating oil make dents in the contact surfaces. As shown in Fig. 12.10, stress is concentrated around these dents and eventually leads to cracking and to surface-originating flaking. The concentration of stress around a dent is expressed by the equation $[P/P_0 \propto (r/c)^{-0.24}]$, where “r” is the radius at the shoulder of the dent and “2c” is the shoulder-to-shoulder width of the dent. The greater the value of “r/c”, the smaller the stress concentration and the longer the service life of the bearing.

NSK is a world leader in the research and development of material properties to reduce the concentration of stress around surface dents. As shown in Fig. 12.11, our work has revealed that a high level of retained austenite is an extremely effective means of maximizing the r/c value around surface dents in the bearing material. TF technology is a unique heat treatment process developed by NSK to optimize the level of retained austenite in bearing materials.

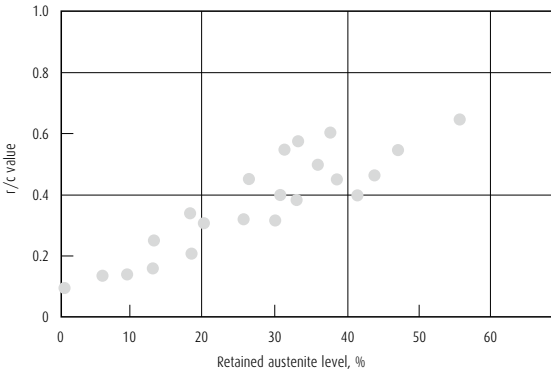

Fig. 12.11 Relationship of r/c Value to Retained Austenite Level

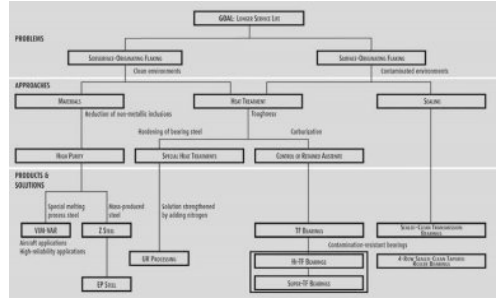

Fig. 12.9 Approaches to Achieving Longer Service Life in Bearings

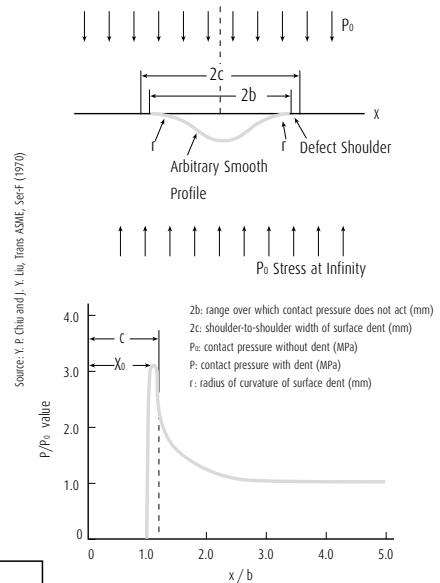

Fig. 12.10 Concentration of Stress around a Surface Dent

(3) Material Properties of Hi-TF Bearings and Super-TF Bearings

NSK has developed the Hi-TF Bearings and Super-TF Bearings as two series of bearings that offer longer service life exceeding that of TF Bearings. As we have seen, the approach to achieving long service life taken in the Super-TF Bearings is to minimize the concentration of stress around the shoulders of surface dents. A high level of retained austenite helps to maximize the value of r/c and reduce the concentration of stress around the dents. However, austenite itself has a soft microstructure, and reduces the hardness of the bearing material. In order to meet the seemingly conflicting needs for greater hardness of the bearing material and a higher level of retained austenite, we decided to adopt a technique that would both promote the uniform distribution and reduce the diameter of carbide and carbonitride particles in the bearing material.

To this end, our researchers have developed a new type of steel that has added the proper quantity of element used in the formation of carbides, and have developed the carbonitriding heat treatment to extract minute carbide and nitride compulsorily for the first time in the world. Hi-TF Bearings adopt a new type of steel named SAC1, which has a specific amount of chrome added to it. Super-TF Bearings adopt a new type of steel named SAC2, which has a specific amount of chrome and molybdenum added to it. Although Super-TF Bearings have a slightly higher product cost than conventional bearings, rise in product cost for the Hi-TF Bearings was avoided by using chrome manganese steel (SAC1) for the material. Figures 12.12 and 12.13 illustrate the image analysis results of carbide distribution in the structures of Super-TF Bearings and an ordinary carburized steel bearing. It is clear that the Super-TF Bearings has a greater amount of fine-size carbide and carbonitride particles. Fig. 12.14 shows that the formations of finer carbide and carbonitride particle give Hi-TF Bearings and Super-TF Bearings a greater degree of hardness and higher retained austenite levels than those of TF Bearings. As a result, Hi-TF Bearings and Super-TF Bearings achieve a higher r/c value. (Fig. 12.15)

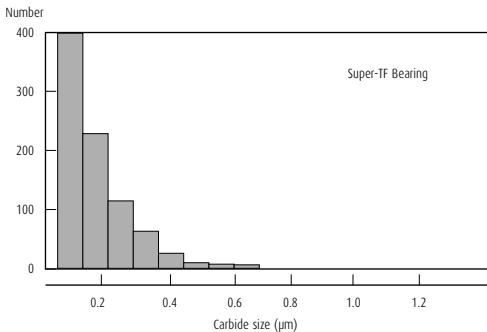

Fig. 12.12 Average Diameter of Carbide and Carbonitride Particles in a Super-TF Bearing

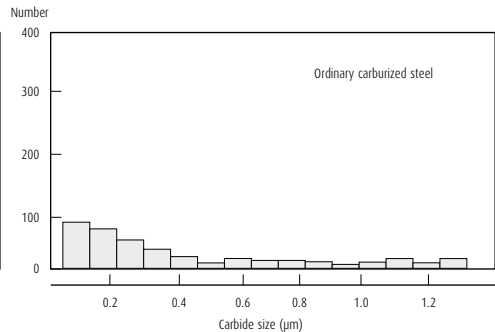

Fig. 12.13 Average Diameter of Carbide Particles in an Ordinary Carburized Steel Bearing

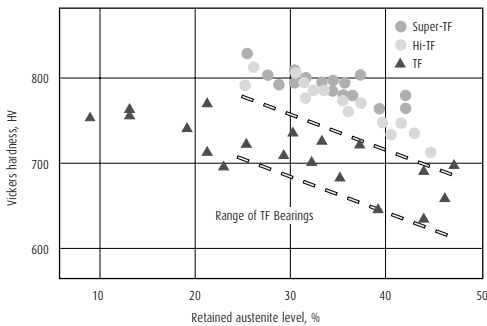

Fig. 12.14 Relationship of Material Hardness and Retained Austenite Level

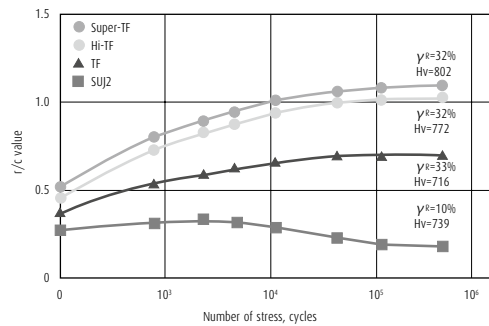

Fig. 12.15 Change of r/c Value under Repeated Stress

Bearing Materials

(4) Service Life under Contaminated Lubrication Conditions

Table 12.10 and Fig. 12.17 show the results of service life tests conducted under contaminated lubrication conditions with NSK L44649/10 tapered roller bearings. If the service life of an ordinary carburized steel bearing of this type is taken as 1, then the L_{10} life of TF, Hi-TF, and Super-TF Bearings would be 4.5, 7.1, and 10.2 respectively (Table 12.10). Hi-TF Bearings and Super-TF Bearings thus offer over seven time and ten times the service life of ordinary carburized steel bearings. Service life is generally affected both by the conditions in which the bearing is used and by the amount of contamination in the lubricant. Under contaminated lubricated conditions, service life may fall to as little as 1/5 of the catalog life.

As a result of attempting longer service life under contaminated lubrication, Hi-TF Bearings and Super-TF Bearings can achieve service life that exceeds the catalog life of existing products under contaminated lubrication for the first time.

Ordinary carburized steel	TF	Hi-TF	Super-TF
1	4.5	7.1	10.2

Table 12.10 Comparison of Service Life of L44649/10 Tapered Roller Bearings

(5) Service Life under Clean Lubrication Conditions

Fig. 12.18 shows the result of service life tests under clean lubrication conditions using 6206 deep groove ball bearings. Under clean lubrication, Hi-TF Bearings and Super-TF Bearings show a slightly longer service life than those made of SUJ2. The most important factor is the cleanliness of the steel from which the bearing is made. Material with a greater degree of purity offers a greater degree of long-life performance.

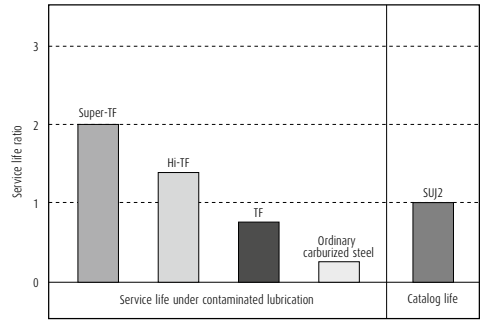

Fig. 12.16 Comparison of Service Life under Contaminated Lubrication

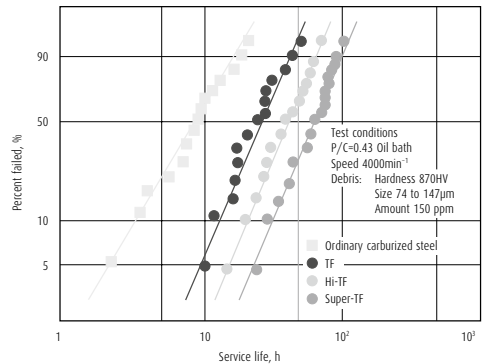

Fig. 12.17 Service Life of L44649/10 Bearings under Contaminated Lubrication

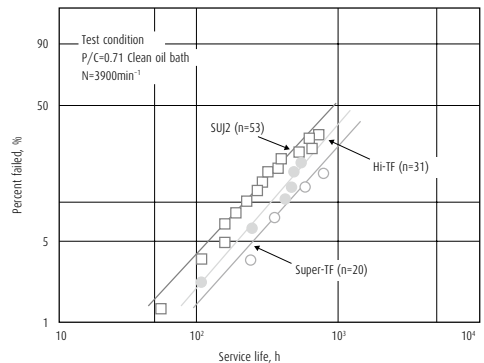

Fig. 12.18 Service Life Tests of 6206 Bearings under Clean Lubrication

(6) Service Life under Boundary Lubrication Conditions

Under boundary lubrication conditions where there is an insufficient amount of EHL film, metal-to-metal contact occurs, thus reducing bearing life. Fig. 12.19 shows the results of service life tests conducted under conditions where oil film parameter λ , which represents the ratio of the thickness of the oil film to the roughness of the surface, is very small ($\lambda=0.3$). When λ is very small, peeling damage occurs (Fig. 12.20), but in Hi-TF Bearings and Super-TF Bearings, the concentration of stress around the projections of the contact area is reduced, giving a service life approximately 4.7 times and 5.5 times greater than that of ordinary carburized steel bearings.

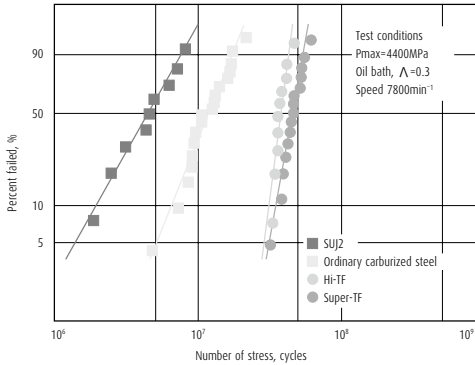

Fig. 12.19 Service Life Tests under Boundary Lubrication Conditions

(7) Wear and Seizure Resistance

Besides extending service life under contaminated lubrication conditions, another goal is to increase the bearing's resistance to wear and seizure by ensuring the dispersion of a large number of fine carbides and nitrides in the bearing material. Fig. 12.21 presents the results of a Sawin-type wear test, showing the degree of wear and the seizure limit for different types of bearing material. The test reveals that Hi-TF Bearings and Super-TF Bearings have superior wear resistance to both SUJ2 steel and TF Bearings. Hi-TF Bearings and Super-TF Bearings are also 20% and 40% more resistant to seizure than both SUJ2 steel and TF Bearings.

(8) Heat Resistance

Fig. 12.22 shows the results of service life tests conducted with 6206 ball bearings at 160°C under clean lubrication conditions. Test results reveal that Super-TF Bearings (heat-resistant specifications) have approximately 4 times the service life of SUJ2X26 steel bearings.

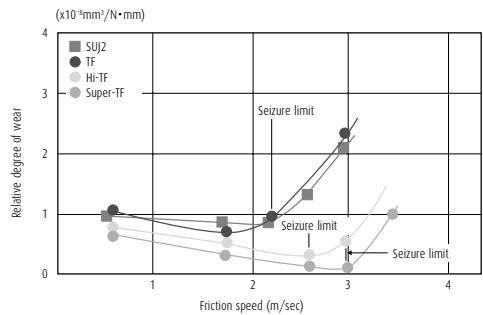
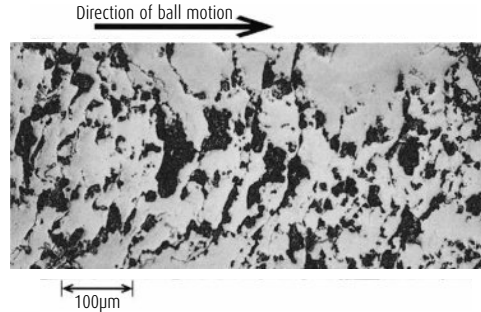

Fig. 12.21 Comparison of Wear Resistance

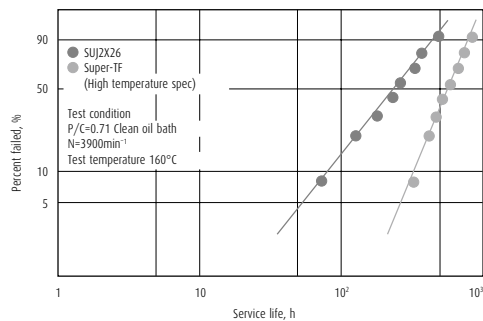

Fig. 12.22 Service Life Test of 6206 under High Temperature Clean Lubrication

Bearing Materials

12.4.6 Physical Properties of Representative Polymers Used as Bearing Material

Because of lightweight, easy formability, and high corrosion resistance, polymer materials are used widely as a material for cages. Polymers may be used independently, but they are usually combined with functional fillers to form a composite material. Composites can be customized to have specific properties. In this way composites can be designed to be bearing materials. For example, fillers can be used to improve such properties as low friction, low wear, non-stick slip characteristic, high limit PV value, non-scrubbing of counterpart material, mechanical properties, and heat resistance, etc.

Table 12.11 shows characteristics of representative polymer materials used for bearings.

Plastics	Elastic modulus (GPa) (°)
Polyethylene HDPE UHMWPE	0.11 50.5
Polyamide Nylon 6 Nylon 66	2.5 3.0
Nylon 11	1.25
Polytetra fluoroethylene PTFE	0.40
Poly buthylene terephthalate PBT	2.7
Polyacetal POM Homo-polymer Co-polymer	3.2 2.9
Polyether sulfon PES	2.46
Polysulfon PSf	2.5
Polyallylate (Aromatic polyester)	1.3 3.0
Polyphenylene sulfide PPS (GF 40%)	4.2
Polyether ether keton PEEK	1.7
Poly-meta-phenylene isophthalic amide	10 (fiber) 7.7 (moid)
Polypromellitic imide (Aromatic polyimide) PI	3 (film) 2.5 to 3.2 (mold)
Polyamide imide PAI	4.7
Polyether imide (Aromatic polyimide) PI	3.6
Polyamino bis-maleimide	—

Table 12.11 Characteristics of Representative Polymers

	Strength GPa (1)	Density g/cm ³	Specific elastic modulus ×10 ⁴ mm	Specific strength ×10 ⁴ mm	Melting point °C	Glass transition temp °C	Thermal deformation temperature °C (2)	Continuous operating temperature °C	Remarks
	0.03 0.025	0.96 0.94	12.6 53.2	3.3 2.7	132 136	-20 -20	75/50 75/50	— —	High creep and toughness, softening
	0.07 0.08	1.13 1.14	221.2 263.2	6.2 7.0	215 264	50 60	150/57 180/60	80 to 120 80 to 120	High water absorption and toughness
	0.04	1.04	120.2	3.8	180	—	150/55	Lower than nylon 6 or 66	Low water absorption
	0.028	2.16	18.5	1.3	327	115	120/—	260	High creep, sintering, low friction and adhesion, inert. Stable at 290°
	0.06	1.31	206.1	4.6	225	30	230/215	155	
	0.07 0.06	1.42 1.41	225.3 205.7	4.9 4.3	175 165	-13 —	170/120 155/110	— 104	High hardness and toughness, low water absorption
	0.086	1.37	179.6	6.3	—	225	210/203	180	Usable up to 200°C Chemically stable
	0.07	1.24	201.6	5.6	—	190	181/175	150	
	0.07 0.075	1.35 1.40	96.3 214.3	5.2 5.4	350 350	— —	293 293	300 260 to 300	Inert, high hardness, Used as filler for PTFE Stable up to 320°
	0.14	1.64	256.1	8.5	275	94	>260	220	Hot cured at 360°
	0.093	1.30	130.8	7.2	335	144	152	240	
	0.7 0.18	1.38 1.33	724.6 579	50.7 13.5	375 415 (decomposition)	>230 >230	280 280	220 220	Fire retardant, heat resistance fiber
	0.17	1.43	203	7.0	Heat decomposition	417 decomposition	360/250	300 (3)	No change in inert gas up to 350°
	0.1	1.43	203	7.0	Heat decomposition	417 decomposition	360/250	260	Usable up to 300°C for bearing. Sintering, no fusion (molded products)
	0.2	1.41	333.3	14.2	—	280	260	210	Usable up to 290°C as adhesive or enamel Improved polyimide of melting forming
	0.107	1.27	240.9	—	—	215	210/200	170	Improved polyimide of melting forming
	0.35	1.6	—	21.9	—	—	330(3)	260	

Notes (1) $\text{GPa} \times 10^4 \text{ kgf/cm}^2 = 10^2 \text{ kgf/mm}^2$

(2) If there is a slash mark “/” in the thermal deformation temperature column, then the value to the left of the “/” applies to 451 kPa, if there, the value relates to 1.82 MPa.

(3) Reference value

Bearing Materials

12.4.7 Characteristics of Nylon Material for Cages

In various bearings these days, plastic cages have come to replace metal cages increasingly. Advantages of using plastic cages may be summarized as follows:

- (1) Lightweight and favorable for use with highspeed rotation
- (2) Self-lubricating and low wear. Worn powders are usually not produced when plastic cages are used. As a result, a highly clean internal state is maintained.
- (3) Low noise appropriate atm silent environments
- (4) Highly corrosion resistant, without rusting
- (5) Highly shock resistant, proving durable under high moment loading
- (6) Easy molding of complicated shapes, ensures high freedom for selection of cage shape. Thus better cage performance can be obtained.

As to disadvantages when compared with metal cages, plastic cages have low heat resistance and limited operating temperature range (normally 120°C). Due attention is also necessary for use because plastic cages are sensitive to certain chemicals. Polyamide resin is a representative plastic cage material. Among polyamide resins, nylon 66 is used in large quantity because of its high heat resistance and mechanical properties.

Polyamide resin contains the amide coupling (-NHCO-) with hydrogen bonding capability in the molecular chain and is characterized by its regulation of mechanical properties and water absorption according to the concentration and hydrogen bonding state. High water absorption (Fig. 12.23) of nylon 66 is generally regarded as a shortcoming because it causes dimensional distortion or deterioration of rigidity. On the other hand, however, water absorption helps enhance flexibility and prevents cage damage during bearing assembly when a cage is required to have a substantial holding interference for the rolling elements. This also causes improvement in toughness which is effective for shock absorption during use. In this way, a so-called shortcoming may be considered as an advantage under certain conditions. Nylon can be improved substantially in strength and heat resistance by adding a small amount of fiber. Therefore, materials reinforced by glass fiber may be used depending on the cage type and application.

In view of maintaining deformation of the cage during assembly of bearings, it is common to use a relatively small amount of glass fiber to reinforce the cage. (Table 12.12) Nylon 66 demonstrates vastly superior performance under mild operating conditions and has wide application possibilities as a mainstream plastic cage material. However, it often develops sudden deterioration under severe conditions (in high temperature oil, etc.). Therefore, due attention should be paid to this material during practical operation.

As an example, Table 12.13 shows the time necessary for the endurance performance of various nylon 66 materials to drop to 50% of the initial value under several different cases. Material deterioration in oil varies depending on the kind of oil. Deterioration is

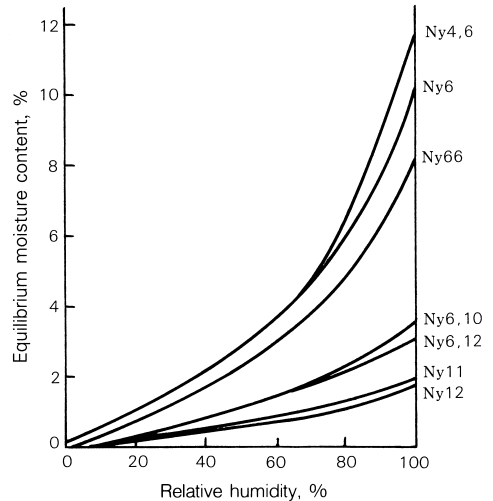

Fig. 12.23 Equilibrium Moisture Content and Relative Humidity of Various Nylons

excessive if the oil contains an extreme-pressure agent. It is known that sulfurous extreme-pressure agents accelerate deterioration more than phosphorous extreme-pressure agents and such deterioration occurs more rapidly with rising temperatures.

On the other hand, material deteriorates less in grease or air than in oil. Besides, materials reinforced with glass fiber can suppress deterioration of the strength through material deterioration by means of the reinforcement effect of glass fibers, thereby, helping to extend the durability period.

Table 12.12 Examples of Applications with Fiber Reinforced Nylon Cages

Bearing type		Main application	Cage material
Ball bearing	Miniature ball bearings	VCR, IC cooling fans	Nylon 66 (Glass fiber content: 0 to 10%)
	Deep groove ball bearings	Alternators, fan motors for air conditioners	
	Angular contact ball bearings	Magnetic clutches, automotive wheels	
Roller bearing	Needle roller bearings	Automotive transmissions	Nylon 66 (Glass fiber content: 10 to 25%)
	Tapered roller bearings	Automotive wheels	
	ET-type cylindrical roller bearings	General	
	H-type spherical roller bearings	General	

Table 12.13 Environmental Resistance of Nylon 66 Resin

Environment	Temperature, °C	Glass content	Hours for the physical property value to drop to 50%, h				Remarks
			500	1000	1500	2000	
Oil	Gear oil	120	0	→	→	→	Contains an extreme pressure additive
		140	A	→	→	→	
	Synthetic lubricating oil	100	A	→	→	→	Contains an extreme pressure additive
		120	A	→	→	→	
		130	A	→	→	→	
		150	B	→	→	→	
	Hydraulic oil	80	D	→	→	→	Contains an extreme pressure additive
		120	D	→	→	→	
		150	D	→	→	→	
	ATF oil	120	D	→	→	→	
		140	A	→	→	→	
	Engine oil	120	D	→	→	→	
	Grease	80	D	→	→	→	
		120	D	→	→	→	
130		A	→	→	→		
Air	160	C	→	→	→		
	180	B	→	→	→		
	180	B	→	→	→		

Class content: A<B<C<D

Bearing Materials

12.4.8 Heat-Resistant Resin Materials for Cages

Currently, polyamide resin shows superior performance under medium operating environmental conditions. This feature plus its relative inexpensiveness lead to its use in increasing quantities. But, the material suffers from secular material deterioration or aging which creates a practical problem during continuous use at 120°C or more or under constant or intermittent contact with either oils (containing an extreme pressure agent) or acids.

Super-engineering plastics should be used for the cage materials of bearings running in severe environments such as high temperature over 150°C or corrosive chemicals. Though super-engineering plastics have good material properties like heat resistance, chemical resistance, rigidity at high temperature, mechanical strength, they have problems with characteristics required for the cage materials like toughness when molding or bearing assembling, weld strength, fatigue resistance. Also, the material cost is expensive. Table 12.14 shows the evaluation results of typical superengineering plastics, which can be injection molded into cage shapes.

Among the materials in Table 12.14, though the branch type polyphenylene sulfide (PPS) is popularly used, the cage design is restricted since forced-removal from the die is difficult due to poor toughness and brittleness. Moreover, PPS is not always good as a cage material, since the claw, stay, ring, or flange of the cage is easily broken on the bearing assembling line. On the other hand, the heat resistant plastic cage developed by NSK, is made of linear-chain high molecules which have been polymerized from molecular chains. These molecular chains do not contain branch or crosslinking so they have high toughness compared to the former material (branch type PPS). Linear PPS is not only superior in heat resistance, oil resistance, and chemical resistance, but also has good mechanical characteristics such as snap fitting (an important characteristic for cages), and high temperature rigidity.

NSK has reduced the disadvantages associated with linear PPS: difficulty of removing from the die and slow crystallization speed, thereby establishing it as a material suitable for cages. Thus, linear PPS is thought to satisfy the required capabilities for a heat resistant cage material considering the relation between the cost and performance.

Classification	Polyether sulfone (PES)
Resin	Amorphous resin
Continuous temp	180°C
Physical properties	<ul style="list-style-type: none"> > Poor toughness (Pay attention to cage shape) > Low weld strength > Small fatigue resistance
Environmental properties	<ul style="list-style-type: none"> > Water absorption (Poor dimensional stability) > Good aging resistance > Poor stress cracking resistance
Material cost (Superiority)	3
Cage application	<ul style="list-style-type: none"> > Many performance problems > High material price

Table 12.14 Properties of Typical Super-Engineering Plastic Materials for Cages

	Polyether imide (PEI)	Polyamide imide (PAI)	Polyether etherketon (PEEK)	Branch type polyphenylene sulfide (PPS)	Linear type polyphenylene sulfide (L-PPS)
	Amorphous resin	Amorphous resin	Crystalline resin	Crystalline resin	Crystalline resin
	170°C	210°C	240°C	220°C	220°C
	<ul style="list-style-type: none"> > Poor toughness (Pay attention to cage shape) > Low weld strength > Small fatigue resistance 	<ul style="list-style-type: none"> > Very brittle (No forced-removal molding) > Special heat treatment before use > High rigidity, after heat treatment 	<ul style="list-style-type: none"> > Excellent toughness, wear and fatigue resistance > Small fatigue resistance 	<ul style="list-style-type: none"> > Excellent mechanical properties > Slightly low toughness 	<ul style="list-style-type: none"> > Excellent mechanical properties > Good toughness > Good dimensional stability (No water absorption)
	<ul style="list-style-type: none"> > Good aging resistance > Poor stress cracking resistance 	<ul style="list-style-type: none"> > Good environment resistance 	<ul style="list-style-type: none"> > Good environment resistance 	<ul style="list-style-type: none"> > Good environment resistance 	<ul style="list-style-type: none"> > Good environment resistance (Not affected by most chemicals. Doesn't deteriorate in high temperature oil with extreme pressure additives).
	2	5	4	1	1
	<ul style="list-style-type: none"> > Many performance problems > High material cost 	<ul style="list-style-type: none"> > Good performance > High material and molding cost (For special applications) 	<ul style="list-style-type: none"> > Excellent performance > High material cost (For special applications) 	<ul style="list-style-type: none"> > Problems with toughness > Cost is high compared to its performance 	<ul style="list-style-type: none"> > Reasonable cost for its performance (For general applications)

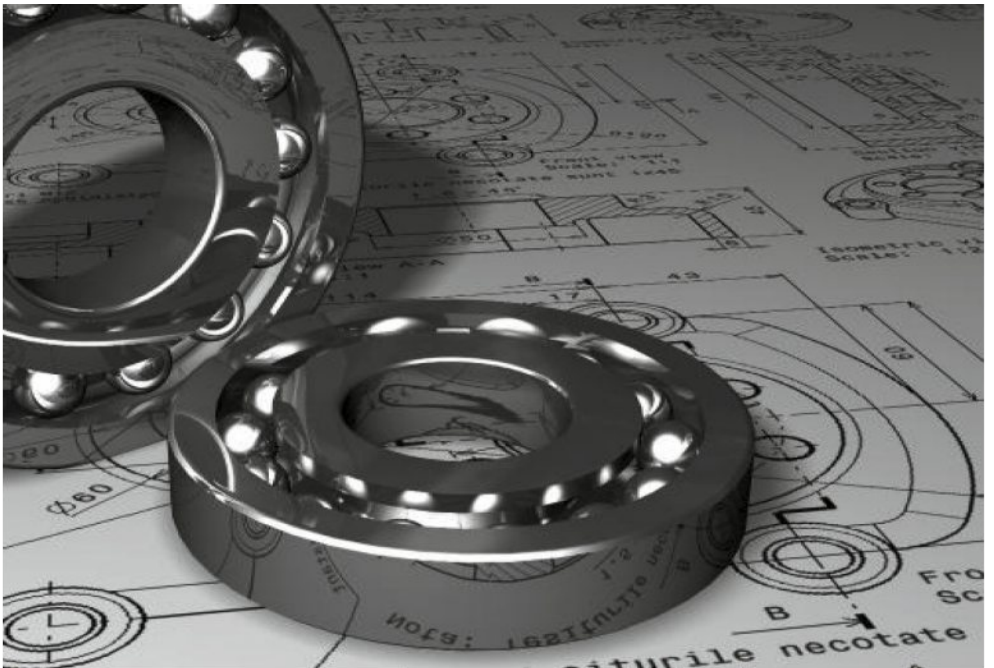

13. DESIGN OF SHAFTS AND HOUSINGS

13.1 Accuracy and Surface Finish of Shafts and Housings	A 270
13.2 Shoulder and Fillet Dimensions	A 270
13.3 Bearing Seals	A 272
13.3.1 Non-Contact Types Seals	A 272
(1) Oil Groove Seals	A 272
(2) Flinger (Slinger) Type Seals	A 273
(3) Labyrinth Seals	A 273
13.3.2 Contact Type Seals	A 274
(1) Oil Seals	A 274
(2) Felt Seals	A 275

13. Design of Shafts and Housings

13.1 Accuracy and Surface Finish of Shafts and Housings

If the accuracy of a shaft or housing does not meet the specification, the performance of the bearings will be affected and they will not provide their full capability. For example, inaccuracy in the squareness of the shaft shoulder may cause misalignment of the bearing inner and outer rings, which may reduce the bearing fatigue life by adding an edge load in addition to the normal load. Cage fracture and seizure sometimes occur for this same reason. Housings should be rigid in order to provide firm bearing support. High rigidity housings are advantageous also from the standpoint of noise, load distribution, etc.

For normal operating conditions, a turned finish or smooth bored finish is sufficient for the fitting surface; however, a ground finish is necessary for applications where vibration and noise must be low or where heavy loads are applied.

In cases where two or more bearings are mounted in one single-piece housing, the fitting surfaces of the housing bore should be designed so both bearing seats may be finished together with one operation such as in-line boring. In the case of split housings, care must be taken in the fabrication of the housing so the outer ring will not become deformed during installation. The accuracy and surface finish of shafts and housings are listed in Table 13.1 for normal operating conditions.

Table 13.1 Accuracy and Roughness of Shaft and Housing

Item	Class of Bearings		Shaft	Housing Bore
Tolerance for Out-of-roundness	Normal,	Class 6	$\frac{IT3}{2}$ to $\frac{IT4}{2}$	$\frac{IT4}{2}$ to $\frac{IT5}{2}$
	Class 5,	Class 4	$\frac{IT2}{2}$ to $\frac{IT3}{2}$	$\frac{IT2}{2}$ to $\frac{IT3}{2}$
Tolerance for Cylindricity	Normal,	Class 6	$\frac{IT3}{2}$ to $\frac{IT4}{2}$	$\frac{IT4}{2}$ to $\frac{IT5}{2}$
	Class 5,	Class 4	$\frac{IT2}{2}$ to $\frac{IT3}{2}$	$\frac{IT2}{2}$ to $\frac{IT3}{2}$
Tolerance for Shoulder Runout	Normal,	Class 6	IT3	IT3 to IT4
	Class 5,	Class 4	IT3	IT3
Roughness of Fitting Surfaces R_a	Small Bearings		0.8	1.6
	Large Bearings		1.6	3.2

Remarks This table is for general recommendation using radius measuring method, the basic tolerance (IT) class should be selected in accordance with the bearing precision class. Regarding the figures of IT, please refer to the Appendix Table 11 (page C016). In cases that the outer ring is mounted in the housing bore with interference or that a thin cross-section bearing is mounted on a shaft and housing, the accuracy of the shaft and housing should be higher since this affects the bearing raceway directly.

13.2 Shoulder and Fillet Dimensions

The shoulders of the shaft or housing in contact with the face of a bearing must be perpendicular to the shaft center line (Refer to Table 13.1). The front face side shoulder bore of the housing for a tapered roller bearing should be parallel with the bearing axis in order to avoid interference with the cage.

The fillets of the shaft and housing should not come in contact with the bearing chamfer; therefore, the fillet radius r_a must be smaller than the minimum bearing chamfer dimension r or r_1 .

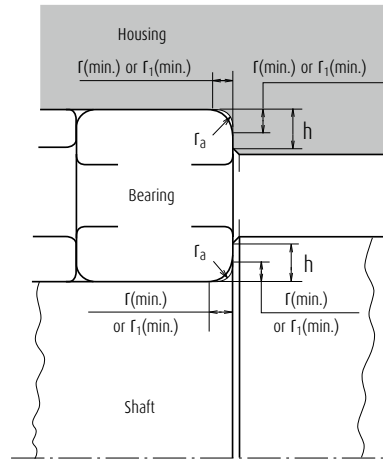

Fig. 13.1 Chamfer Dimensions, Fillet Radius of Shaft and Housing, and Shoulder Height

The shoulder heights for both shafts and housings for radial bearings should be sufficient to provide good support over the face of the bearings, but enough face should extend beyond the shoulder to permit use of special dismantling tools. The recommended minimum shoulder heights for metric series radial bearings are listed in Table 13.2.

Nominal dimensions associated with bearing mounting are listed in the bearing tables including the proper shoulder diameters. Sufficient shoulder height is particularly important for supporting the side ribs of tapered roller bearings and cylindrical roller bearings subjected to high axial loads.

The values of h and r_a in Table 13.2 should be adopted in those cases where the fillet radius of the shaft or housing is as shown in Fig. 13.2 (a), while the values in Table 13.3 are generally used with an undercut fillet radius produced when grinding the shaft as shown in Fig. 13.2 (b).

Table 13.2 Recommended Minimum Shoulder Heights for Use with Metric Series Radial Bearings

Units : mm

Nominal Chamfer Dimensions	Shaft or Housing		
	Fillet Radius r_a (max.)	Minimum Shoulder Heights h (min.)	
		Deep Groove Ball Bearings, Self-Aligning Ball Bearings, Cylindrical Roller Bearings, Solid Needle Roller Bearings	Angular Contact Ball Bearings, Tapered Roller Bearings, Spherical Roller Bearings
r (min.) or r_1 (min.)			
0.05	0.05	0.2	-
0.08	0.08	0.3	-
0.1	0.1	0.4	-
0.15	0.15	0.6	-
0.2	0.2	0.8	-
0.3	0.3	1	1.25
0.6	0.6	2	2.5
1	1	2.5	3
1.1	1	3.25	3.5
1.5	1.5	4	4.5
2	2	4.5	5
2.1	2	5.5	6
2.5	2	-	6
3	2.5	6.5	7
4	3	8	9
5	4	10	11
6	5	13	14
7.5	6	16	18
9.5	8	20	22
12	10	24	27
15	12	29	32
19	15	38	42

Remarks

1. When heavy axial loads are applied, the shoulder height must be sufficiently higher than the values listed.
2. The fillet radius of the corner is also applicable to thrust bearings.
3. The shoulder diameter is listed instead of shoulder height in the bearing tables.

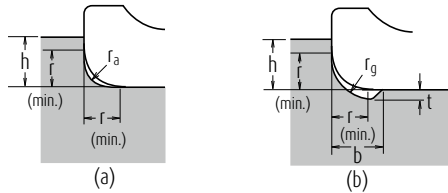

Fig. 13.2 Chamfer Dimensions, Fillet Radius, and Shoulder Height

Table 13.3 Shaft Undercut

Units : mm

Chamfer Dimensions of Inner and Outer Rings	Undercut Dimensions		
	t	r_g	b
r (min.) or r_1 (min.)			
1	0.2	1.3	2
1.1	0.3	1.5	2.4
1.5	0.4	2	3.2
2	0.5	2.5	4
2.1	0.5	2.5	4
2.5	0.5	2.5	4
3	0.5	3	4.7
4	0.5	4	5.9
5	0.6	5	7.4
6	0.6	6	8.6
7.5	0.6	7	10

Design of Shafts and Housings

For thrust bearings, the squareness and contact area of the supporting face for the bearing rings must be adequate. In the case of thrust ball bearings, the housing shoulder diameter D_a should be less than the pitch circle diameter of the balls, and the shaft shoulder diameter d_a should be greater than the pitch circle diameter of the balls (Fig. 13.3).

For thrust roller bearings, it is advisable for the full contact length between rollers and rings to be supported by the shaft and housing shoulder (Fig. 13.4).

These diameters d_a and D_a are listed in the bearing tables.

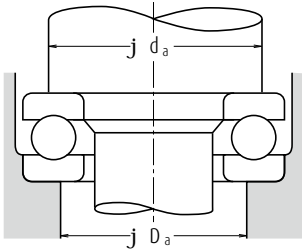

Fig. 13.3 Face Supporting Diameters for Thrust Ball Bearings

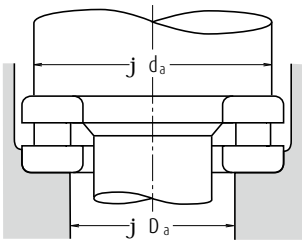

Fig. 13.4 Face Supporting Diameters for Thrust Roller Bearings

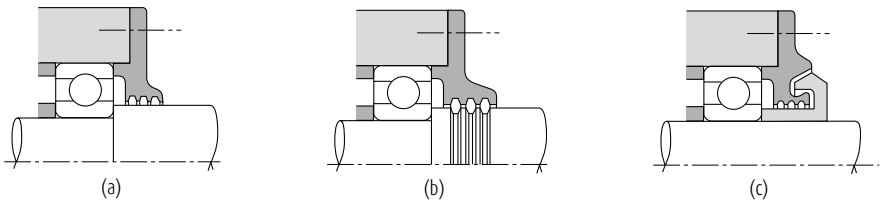

Fig. 13.5 Examples of Oil Grooves

13.3 Bearing Seals

To insure the longest possible life of a bearing, it may be necessary to provide seals to prevent leakage of lubricant and entry of dust, water and other harmful material like metallic particles. The seals must be free from excessive running friction and the probability of seizure. They should also be easy to assemble and disassemble. It is necessary to select a suitable seal for each application considering the lubricating method.

13.3.1 Non-Contact Type Seals

Various sealing devices that do not contact the shaft, such as oil grooves, flingers, and labyrinths, are available. Satisfactory sealing can usually be obtained with such seals because of their close running clearance. Centrifugal force may also assist in preventing internal contamination and leakage of the lubricant.

(1) Oil Groove Seals

The effectiveness of oil groove seals is obtained by means of the small gap between the shaft and housing bore and by multiple grooves on either or both of the housing bore and shaft surface (Fig. 13.5 (a), (b)).

Since the use of oil grooves alone is not completely effective, except at low speeds, a flinger or labyrinth type seal is often combined with an oil groove seal (Fig. 13.5 (c)). The entry of dust is impeded by packing grease with a consistency of about 200 into the grooves.

The smaller the gap between the shaft and housing, the greater the sealing effect; however, the shaft and housing must not come in contact while running. The recommended gaps are given in Table 13.4.

The recommended groove width is approximately 3 to 5 mm, with a depth of about 4 to 5 mm. In the case of sealing methods using grooves only, there should be three or more grooves.

(2) Flinger (Slinger) Type Seals

A flinger is designed to force water and dust away by means of the centrifugal force acting on any contaminants on the shaft. Sealing mechanisms with flingers inside the housing as shown in Fig. 13.6 (a), (b) are mainly intended to prevent oil leakage, and are used in environments with relatively little dust. Dust and moisture are prevented from entering by the centrifugal force of flingers shown in Figs. 13.6 (c), (d).

Table 13.4 Gaps between Shafts and Housings for Oil-Groove Type Seals

Units : mm

Nominal Shaft Diameter	Radial Gap
Under 50	0.25 to 0.4
50-200	0.5 to 1.5

(3) Labyrinth Seals

Labyrinth seals are formed by interdigitated segments attached to the shaft and housing that are separated by a very small gap. They are particularly suitable for preventing oil leakage from the shaft at high speeds.

The type shown in Fig. 13.7 (a) is widely used because of its ease of assembly, but those shown in Figs. 13.7 (b), (c) have better seal effectiveness.

Table 13.5 Labyrinth Seal Gaps

Units : mm

Nominal Shaft Diameter	Labyrinth Gaps	
	Radial Gap	Axial Gap
Under 50	0.25 to 0.4	1 to 2
50-200	0.5 to 1.5	2 to 5

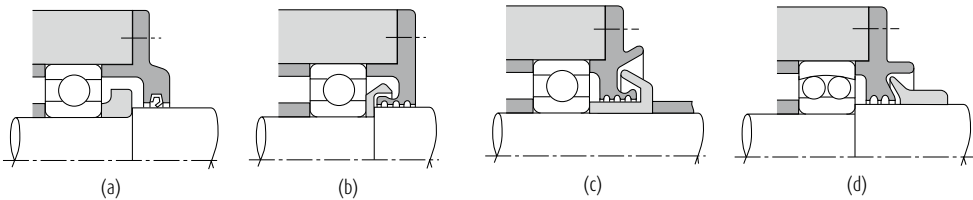

Fig. 13.6 Examples of Flinger Configurations

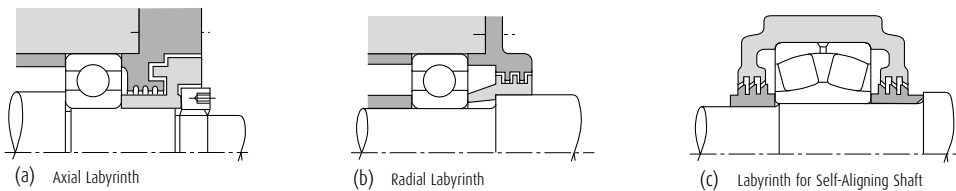

Fig. 13.7 Examples of Labyrinth Designs

Design of Shafts and Housings

13.3.2 Contact Type Seals

The effectiveness of contact seals is achieved by the physical contact between the shaft and seal, which may be made of synthetic rubber, synthetic resin, felt, etc. Oil seals with synthetic rubber lips are most frequently used.

(1) Oil Seals

Many types of oil seals are used to prevent lubricant from leaking out as well as to prevent dust, water, and other foreign matter from entering (Figs. 13.8 and 13.9).

In Japan, such oil seals are standardized (Refer to JIS B 2402) on the basis of type and size. Since many oil seals are equipped with circumferential springs to maintain adequate contact force, oil seals can follow the non-uniform rotational movement of a shaft to some degree.

Seal lip materials are usually synthetic rubber including nitrile, acrylate, silicone, and fluorine. Tetrafluoride ethylene is also used. The maximum allowable operating temperature for each material increases in this same order.

Synthetic rubber oil seals may cause trouble such as overheating, wear, and seizure, unless there is an oil film between the seal lip and shaft. Therefore, some lubricant should be applied to the seal lip when the seals are installed. It is also desirable for the lubricant inside the housing to spread a little between the sliding surfaces.

However, please be aware that ester-based grease will cause acrylic rubber material to swell. Also, low aniline point mineral oil, silicone-based grease, and silicon-based oil will cause silicone-based material to swell. Moreover, urea-based grease will cause fluorine-based material to deteriorate.

The permissible circumferential speed for oil seals varies depending on the type, the finish of the shaft surface, liquid to be sealed, temperature, shaft eccentricity, etc. The temperature range for oil seals is restricted by the lip material. Approximate circumferential surface speeds and temperature permitted under favorable conditions are listed in Table 13.6.

When oil seals are used at high circumferential surface speed or under high internal pressure, the contact surface of the shaft must be smoothly finished and the shaft eccentricity should be less than 0.02 to 0.05 mm.

The hardness of the shaft's contact surface should be made higher than HRC 40 by means of heat treatment or hard chrome plating in order to gain abrasion resistance. If possible, a hardness of more than HRC 55 is recommended.

The approximate level of contact surface finish required for several shaft circumferential surface speeds is given in Table 13.7.

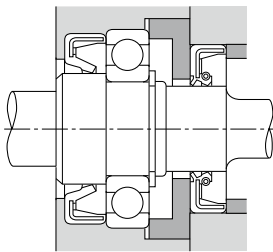

Fig. 13.8 Example of Application of Oil Seal (1)

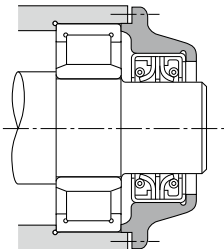

Fig. 13.9 Example of Application of Oil Seal (2)

Table 13.6 Permissible Circumferential Surface Speeds and Temperature Range for Oil Seals

Seal Materials		Permissible Circumferential Speeds (m/sec)	Operating Temperature Range (°C) (1)
Synthetic Rubber	Nitrile Rubber	Under 16	-25 to +100
	Acrylic Rubber	Under 25	-15 to +130
	Silicone Rubber	Under 32	-70 to +200
	Fluoropolymer + rubber	Under 32	-30 to +200
Tetrafluoride Ethylene Resin		Under 15	-50 to +220

Note (1) The upper limit of the temperature range may be raised about 20 °C for operation for short intervals.

Table 13.7 Shaft Circumferential Surface Speeds and Finish of Contact Surfaces

Circumferential Surface Speeds (m/s)	Surface Finish R_a (μm)
Under 5	0.8
5 to 10	0.4
Over 10	0.2

(2) Felt Seals

Felt seals are one of the simplest and most common seals used for transmission shafts, etc.

However, since oil permeation and leakage are unavoidable if oil is used, this type of seal is used only for grease lubrication, primarily to prevent dust and other foreign matter from entering. Felt seals are not suitable for circumferential surface speeds exceeding 4 m/sec; therefore, it is preferable to replace them with synthetic rubber seals depending on the application.





BEARINGS TABLE



Part B

BEARINGS TABLE

1. Deep Groove Ball Bearings	B 005
2. Extra Small Ball Bearings and Miniature Ball Bearings	B 055
3. Angular Contact Ball Bearings	B 073
4. Self-Aligning Ball Bearings	B 119
5. Cylindrical Roller Bearings	B 141
6. Tapered Roller Bearings	B 199
7. Spherical Roller Bearings	B 275
8. Thrust Ball Bearings	B 313
9. Thrust Cylindrical Roller Bearings	B 331
10. Thrust Tapered Roller Bearings	B 339
11. Thrust Spherical Roller Bearings	B 349
12. Ball Bearing Units	B 359
13. Accessories for Rolling Bearings	B 375

Deep Groove Ball Bearings



1. DEEP GROOVE BALL BEARINGS

INTRODUCTION	B 006
--------------------	-------

TECHNICAL DATA

Radial and Axial Internal Clearances and Contact Angles for Single-Row Deep Groove Ball Bearings	B 012
Features and Operating Temperature Range of Ball Bearing Seal Material.....	B 016
Free Space and Grease Filling Amount for Deep Groove Ball Bearings	B 018

BEARINGS TABLE

SINGLE-ROW DEEP GROOVE BALL BEARINGS

	Bore Dia.	Page
Open Type, Shielded Type, Sealed Type	10 - 240 mm.....	B 020
Open Type	260 - 800 mm.....	B 040

CREEP-FREE BEARINGS

	Bore Dia.	Page
	10 - 100 mm.....	B 046

Double Row

	Bore Dia.	Page
	10 - 90 mm.....	B 048

MAXIMUM TYPE BALL BEARINGS

	Bore Dia.	Page
	25 - 110 mm.....	B 050

MAGNETO BEARINGS

	Bore Dia.	Page
	4 - 20 mm.....	B 052



Deep Groove Ball Bearings

DESIGN, TYPES, AND FEATURES

SINGLE-ROW DEEP GROOVE BALL BEARINGS

Single-Row Deep Groove Ball Bearings are classified into the types shown below.

The proper amount of good quality grease is packed in shielded and sealed ball bearings. A comparison of the features of each type is shown in Table 1.

Table 1 Features of Sealed Ball Bearings

Type	Shielded Type (ZZ Type)	Non-Contact Rubber Sealed Type (VV Type)	Contact Rubber Sealed Type (DDU Type)
Torque	Low	Low	Higher than ZZ, VV types due to contact seal
Speed capability	Good	Good	Limited by contact seals
Grease sealing effectiveness	Good	Better than ZZ type	A little better than VV type
Dust resistance	Good	Better than ZZ type (usable in moderately dusty environment)	Best (usable even in very dusty environment)
Water resistance	Not suitable	Not suitable	Good (usable even if fluid is splashed on bearing)
Operating temperature (1)	-10 to +110°C	-10 to +110°C	-10 to +100°C

Note (1) The above temperature range applies to standard bearings. By using cold or heat resistant grease and changing the type of rubber, the operating temperature range can be extended. For such applications, please contact NSK.

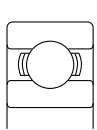

Open Type

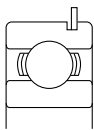

With Snap Ring

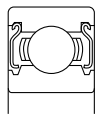

Shielded Type
(ZZ Type)

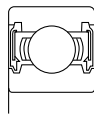

Non-Contact
Rubber Sealed
Type (VV Type)

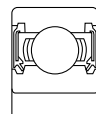

Contact
Rubber Sealed
Type (DDU Type)

For deep groove ball bearings, pressed cages are usually used. For big bearings, machined brass cages are used. (Refer to Table 2). Machined cages are also used for high speed applications.

Table 2 Standard Cages for Deep Groove Ball Bearings

Series	Pressed Steel Cages	Machined Brass Cages
68	6800 - 6838	6840 - 68/800
69	6900 - 6936	6938 - 69/800
160	16001 - 16026	16028 - 16064
60	6000 - 6040	6044 - 60/670
62	6200 - 6240	6244 - 6272
63	6300 - 6332	6334 - 6356

Table 3 Standard Cages for Double Row Deep Groove Ball Bearings

Series	Polyamid Cages
42xxB	4200B - 4218B
43xxB	4302B - 4315B

c Formulation of Bearing Numbers

Single-Row Deep Groove Ball Bearings

Bearing number example:

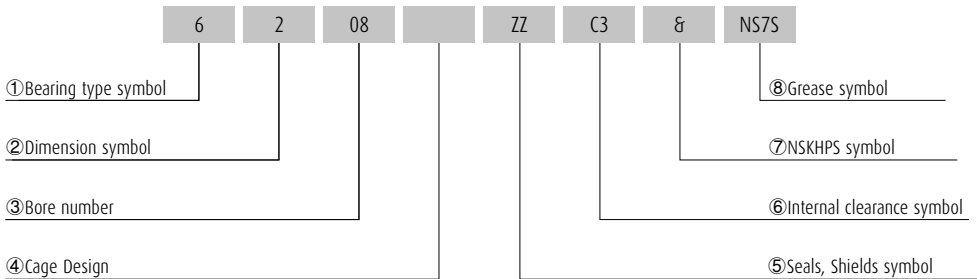

- ① Bearing type symbol 6 : Single-Row Deep Groove Ball Bearings : 4 Double Row Deep Groove Ball Bearing
- ② Dimension symbol 2 : 02 Series, 3 : 03 Series, 9 : 19 Series, 0 : 10 Series
- ③ Bore number Less than 03, Bearing bore 00 : 10mm, 01 : 12mm, 02 : 15mm, 03 : 17mm
Over 04, Bearing bore Bore number X 5 (mm)
- ④ Cage Design Blanck: Steel, T/T1X: Plastic, M: Brass
- ⑤ Seals, Shields symbol ZZ : Shield on Both Side , DDU : Contact Rubber Seal on Both Side, VV: Non-Contact Rubber Sealed on Both Side
- ⑥ Internal clearance symbol Omitted : CN clearance*1, C3 : Clearance greater than CN, C4 : Clearance greater than C3, CM : For Electric Motors*1
- ⑦ NSKHPS symbol & : NSKHPS Bearings
- ⑧ Grease symbol NS7 : NS HI-LUBE

*1 The CM clearance can be used in substitute of the CN clearance. (The opposite is not available.)

Deep Groove Ball Bearings

Creep-Free Bearings

Creep-Free Bearings, which come with two O-rings mounted in the outer ring, help to prevent the occurrence of creep by restricting the amount of clearance between the outer ring and housing.

No special machining is required; bearings can be used with the same housing as standard bearings.

In creep limit load tests, the more housing clearance is reduced, the greater the improvement in creep prevention, due to the tension of the O-ring mounted in the outer ring.



Features

> Prevents creep

O-rings help prevent creep.

> Reusable housing

Very little abrasion occurs on the bore surface of the housing, making reuse possible.

> Easy to assemble

Assembly is easy since bearings can be fitted with a loose tolerance.

> No special machining of the housing is required

Bearings can be replaced since boundary dimensions are identical to standard bearings. No reworking of the housing is required.

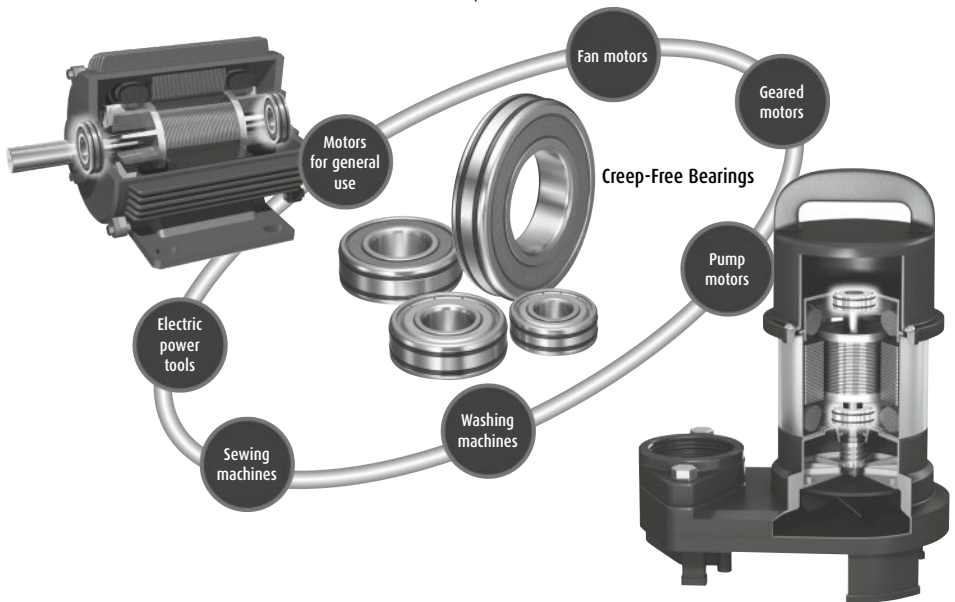

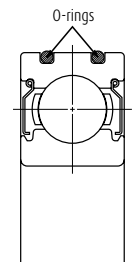

Fig. 1 Structure of Creep-Free Bearings

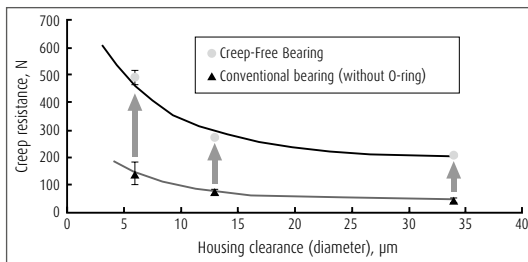

Fig. 2 Creep limit load test (example: 6204)

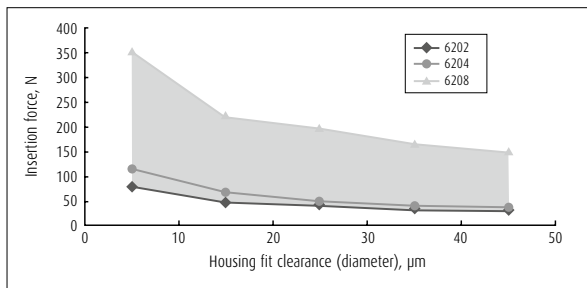

Fig. 3 Fit and insertion force

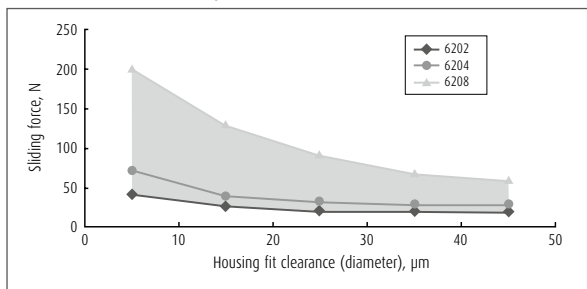

Fig. 4 Fit and sliding force



Note on mounting Creep-Free Bearings

- > When oil or grease is applied to the outer diameter of the bearing, use a mineral oil or a synthetic hydrocarbon oil (NSK's EA2, etc.).
- > O-ring material is nitrile rubber (operating temperature range: -30 to 120°C) as a standard specification. Please contact NSK for use under special environments such as high temperatures.

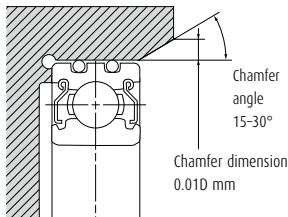
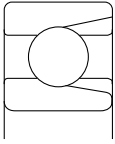

Fig. 5 Housing shape and dimension

Note on the product name "Creep-Free Bearings": The term "free" should not be construed to mean that creep is nonexistent.

Deep Groove Ball Bearings



MAXIMUM TYPE BALL BEARINGS

Maximum Type Ball Bearings contain a larger number of balls than normal deep groove ball bearings because of filling slots in the inner and outer rings. Because of their filling slots, they are not suitable for applications with high axial loads.

BL2 and BL3 types of bearings have boundary dimensions equal to those of single-row deep groove ball bearings of Series 62 and 63 respectively. Besides the open type, ZZ type shielded bearings are also available.

When using these bearings, it is important for the filling slot in the outer ring to be outside of the loaded zone as much as possible.

Their cages are pressed steel.

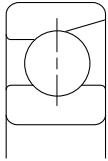

MAGNETO BEARINGS

The groove in the inner ring is a little shallower than that of deep groove ball bearings and one side of the outer ring is relieved. Consequently, the outer ring is separable, which makes it convenient for mounting.

Pressed cages are standard, but for high speed applications, machined synthetic resin cages are used.

PRECAUTIONS FOR USE OF DEEP GROOVE BALL BEARINGS

For deep groove ball bearings, if the bearing load is too small during operation, slippage occurs between the balls and raceways, which may result in smearing. The higher the weight of balls and cage, the higher this tendency becomes, especially for large bearings. If very small bearing loads are expected, please contact NSK for selection of an appropriate bearing.

TOLERANCES AND RUNNING ACCURACY

	Table	Pages
Single-Row Deep Groove Ball Bearings	7.2	A128 to A131
Maximum Type Ball Bearings	7.2	A128 to A131
Magneto Bearings	7.5	A138 and A139

RECOMMENDED FITS

	Table	Page
Single-Row Deep Groove Ball Bearings	8.3	A164
	8.5	A165
Maximum Type Ball Bearings	8.3	A164
	8.5	A165
Magneto Bearings	8.3	A164
	8.5	A165

INTERNAL CLEARANCE

	Table	Page
Single-Row Deep Groove Ball Bearings	8.10	A169
Maximum Type Ball Bearings	8.11	A169
Magneto Bearings	8.12	A169

LIMITING SPEEDS (GREASE/OIL)

The limiting speeds (grease) and limiting speeds (oil) listed in the bearing tables should be adjusted depending on the bearing load condition. Also, higher speeds are attainable by making changes in the lubrication method, cage design, etc. Refer to page A098 for detailed information.



Deep Groove Ball Bearings

TECHNICAL DATA

Radial and Axial Internal Clearances and Contact Angles for Single Row Deep Groove Ball Bearings

(1) Radial and Axial Internal Clearances

The internal clearance in single row bearings has been specified as the radial internal clearance. The bearing internal clearance is the amount of relative displacement possible between the bearing rings when one ring is fixed and the other ring does not bear a load. The amount of movement along the direction of the bearing radius is called the radial clearance, and the amount along the direction of the axis is called the axial clearance.

The geometric relation between the radial and axial clearance is shown in Fig. 1.

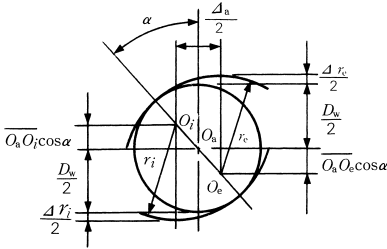

Fig. 1 Relationship Between Δr and Δa

Symbols used in Fig. 1

O_b :	Ball center
O_e :	Center of groove curvature, outer ring
O_i :	Center of groove curvature, inner ring
D_w :	Ball diameter (mm)
r_e :	Radius of outer ring groove (mm)
r_i :	Radius of inner ring groove (mm)
a :	Contact angle ($^\circ$)
Δr :	Radial clearance (mm)
Δa :	Axial clearance (mm)

It is apparent from Fig. 1 that $\Delta r = \Delta r_e + \Delta r_i$.

From geometric relationships, various equations for clearance, contact angle, etc. can be derived.

$$\Delta r = 2(1 - \cos a)(r_e + r_i - D_w) \dots \dots \dots (1)$$

$$\Delta a = 2 \sin a (r_e + r_i - D_w) \dots \dots \dots (2)$$

$$\frac{\Delta a}{\Delta r} = \cot \frac{a}{2} \dots \dots \dots (3)$$

$$\Delta H2 (r_e + r_i - D_w)^{1/2} \Delta r^{1/2} \dots \dots \dots (4)$$

$$a = \cos^{-1} \left(\frac{r_e + r_i - D_w - \frac{\Delta r}{2}}{r_e + r_i - D_w} \right) \dots \dots \dots (5)$$

$$a = \sin^{-1} \left(\frac{\Delta a / 2}{r_e + r_i - D_w} \right) \dots \dots \dots (6)$$

Because $(r_e + r_i - D_w)$ is a constant, it is apparent why fixed relationships between Δr , Δa and a exist for all the various bearing types.

As was previously mentioned, the clearances for deep groove ball bearings are given as radial clearances, but there are specific applications where it is desirable to have an axial clearance as well. The relationship between deep groove ball bearing radial clearance Δr and axial clearance Δa is given in Equation (4).

To simplify,

$$\Delta a = K \Delta r^{1/2} \dots \dots \dots (7)$$

where K: Constant depending on bearing design

$$K = 2 (r_e + r_i - D_w)^{1/2}$$

Fig. 2 shows one example. The various values for K are presented by bearing size in Table 1 below.

Example

Assume a 6312 bearing, for a sample calculation, which has a radial clearance of 0.017 mm. From Table 1, $K=2.09$.

Therefore, the axial clearance Δa is:

$$\Delta a = 2.09 \times \sqrt{0.017} = 2.09 \times 0.13 = 0.27 \text{ (mm)}$$

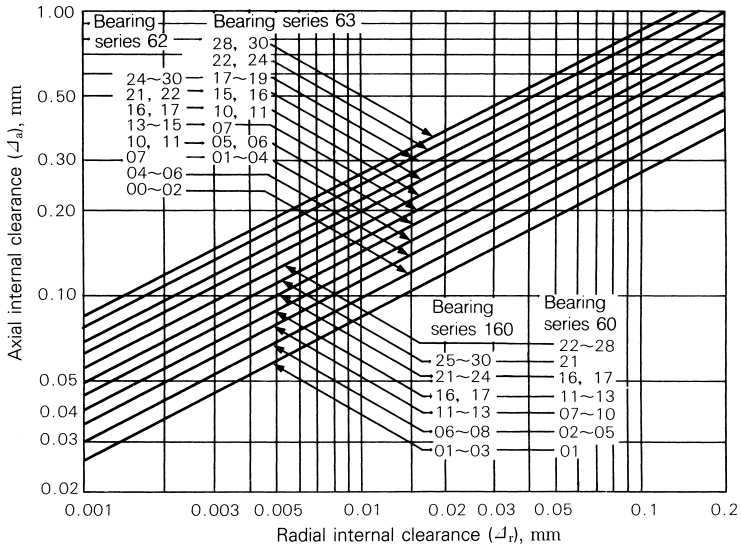

Fig. 2 Radial Clearance, Δ_r and Axial Clearance, Δ_a of Deep Groove Ball Bearings

Table 1 Constant Values of K for Radial and Axial Clearance Conversion

Bearing bore No.	K			
	Series 160	Series 60	Series 62	Series 63
00	-	-	0.93	1.14
01	0.80	0.80	0.93	1.06
02	0.80	0.93	0.93	1.06
03	0.80	0.93	0.99	1.11
04	0.90	0.96	1.06	1.07
05	0.90	0.96	1.06	1.20
06	0.96	1.01	1.07	1.19
07	0.96	1.06	1.25	1.37
08	0.96	1.06	1.29	1.45
09	1.01	1.11	1.29	1.57
10	1.01	1.11	1.33	1.64
11	1.06	1.20	1.40	1.70
12	1.06	1.20	1.50	2.09
13	1.06	1.20	1.54	1.82
14	1.16	1.29	1.57	1.88
15	1.16	1.29	1.57	1.95
16	1.20	1.37	1.64	2.01
17	1.20	1.37	1.70	2.06
18	1.29	1.44	1.76	2.11
19	1.29	1.44	1.82	2.16
20	1.29	1.44	1.88	2.25
21	1.37	1.54	1.95	2.32
22	1.40	1.64	2.01	2.40
24	1.40	1.64	2.06	2.40
26	1.54	1.70	2.11	2.49
28	1.54	1.70	2.11	2.59
30	1.54	1.76	2.11	2.59

Deep Groove Ball Bearings

(2) Relation between Radial Clearance and Contact Angle

Single-row deep groove ball bearings are sometimes used as thrust bearings. In such applications, it is recommended to make the contact angle as large as possible.

The contact angle for ball bearings is determined by the geometric relationship between the radial clearance and the radii of the inner and outer grooves. Using Equations (1) to (6), Fig. 3 shows the particular relationship between the radial clearance and contact angle of 62 and 63 series bearings. The initial contact angle, α_0 , is the initial contact angle when the axial load is zero. Application of any load to the bearing will change this contact angle.

If the initial contact angle α_0 exceeds 20° , it is necessary to check whether or not the contact area of the ball and raceway touch the edge of raceway shoulder. (Refer to Section 8.1.2)

For applications when an axial load alone is applied, the radial clearance for deep groove ball bearings is normally greater than the normal clearance in order to ensure that the contact angle is relatively large. The initial contact angles for C3 and C4 clearances are given for selected bearing sizes in Table 2 below.

Table 2 Initial Contact Angle, α_0 , with C3 and C4 Clearances

Bearing No.	α_0 with C3	α_0 with C4
6205	12.5° to 18°	16.5° to 22°
6210	11.5° to 16.5°	13.5° to 19.5°
6215	11.5° to 16°	15.5° to 19.5°
6220	10.5° to 14.5°	14° to 17.5°
6305	11° to 16°	14.5° to 19.5°
6310	9.5° to 13.5°	12° to 16°
6315	9.5° to 13.5°	12.5° to 15.5°
6320	9° to 12.5°	12° to 15°

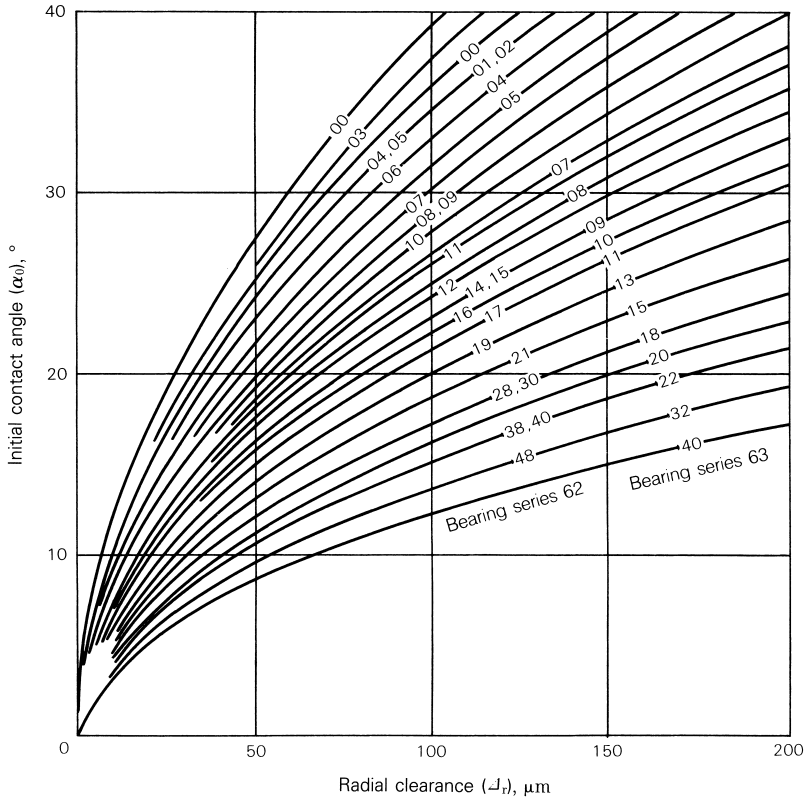

Fig. 3 Radial Clearance and Contact Angle

Deep Groove Ball Bearings

Features and Operating Temperature Range of Ball Bearing Seal Material

The sealed ball bearing is a ball bearing with seals as shown in Figs. 1 and 2. There are two seal types: non-contact seal type and contact seal type. For rubber seal material, nitrile rubber is used for general purpose and poly-acrylic rubber, silicon rubber, and fluoric rubber are used depending on temperature conditions.

These rubbers have their own unique nature and appropriate rubber must be selected by considering the particular application environment and running conditions.

Table 1 shows principal features of each rubber material and the operating temperature range of the bearing seal. The operating temperature range of Table 1 is a guideline for continuous operation. Thermal aging of rubber is related to the temperature and time. Rubber may be used in a much wider range of operating temperatures depending on the operating time and frequency.

In the non-contact seal, heat generation due to friction on the lip can be ignored. And thermal factors, which cause aging of the rubber, are physical changes due to atmospheric and bearing temperatures. Accordingly, increased hardness or loss of elasticity due to thermal aging exerts only a negligible effect on the seal performance. A rubber non-contact seal can thus be used in an expanded range of operating temperatures greater than that for a contact seal.

But there are some disadvantages. The contact seal has a problem with wear occurring at the seal lip due to friction, thermal plastic deformation, and hardening. When friction or plastic deformation occurs, the contact pressure between the lip and slide surface decreases, resulting in a clearance. This clearance is minimum and does not cause excessive degradation of sealing performance (for instance, it does not allow dust entry or grease leakage). In most cases, this minor plastic deformation or slightly increased hardness presents no practical problems.

However, in external environments with dust and water in large quantity, the bearing seal is used as an auxiliary seal and a principal seal should be provided separately. As so far described, the operating temperature range of rubber material is only a guideline for selection. Since heat resistant rubber is expensive, it is important to understand the temperature conditions so that an economical selection can be made. Due attention should also be paid not only to heat resistance, but also to the distinctive features of each rubber.

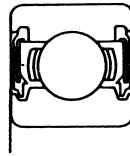

Non-contact
rubber seal (VV)

Fig. 1

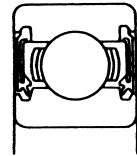

Contact
rubber seal (DDU)

Fig. 2

Table 1 Features and Operating Temperature Range of Rubber Materials

Material		Nitrile rubber	Polyacrylic rubber	Silicon rubber	Fluorine rubber
Key features		<ul style="list-style-type: none"> a Most popular seal material a Superior in oil and wear resistances and mechanical properties a Readily ages under direct sunrays a Less expensive than other rubbers 	<ul style="list-style-type: none"> a Superior in heat and oil resistances a Large compression causes permanent deformation a Inferior in cold resistance a One of the less expensive materials among the high temperature materials a Attention is necessary because it swells the ester oil based grease 	<ul style="list-style-type: none"> a High heat and cold resistances a Inferior in mechanical properties other than permanent deformation by compression. Pay attention to tear strength a Pay attention so as to avoid swell caused by low aniline point mineral oil, silicone grease, and silicone oil 	<ul style="list-style-type: none"> a High heat resistance a Superior in oil and chemical resistances a Cold resistance similar to nitrile rubber a Attention is necessary because it deteriorates the urea grease
Operating temperature range ⁽¹⁾ (°C)	Non-contact seal	-50 to +130	-30 to +170	-100 to +250	-50 to +220
	Contact seal	-30 to +110	-15 to +150	-70 to +200	-30 to +200

Note ⁽¹⁾ This operating temperature is the temperature of seal rubber materials.

Notes ⁽⁴⁾ Snap ring groove dimensions and snap ring dimensions are not conformed to ISO15.

- Remarks**
1. Diameter Series 7 (extra thin section bearings) are also available, please contact NSK.
 2. When using bearings with rotating outer rings, contact NSK if they are sealed, shielded, or have snap rings.

Deep Groove Ball Bearings

Free Space and Grease Filling Amount for Deep Groove Ball Bearings

Grease lubrication can simplify the bearing's peripheral construction. In place of oil lubrication, grease lubrication is now employed along with enhancement of the grease quality for applications in many fields. It is important to select a grease appropriate to the operating conditions. Due care is also necessary as to the filling amount, since too much or too little grease greatly affects the temperature rise and torque. The amount of grease needed depends on such factors as housing construction, free space, grease brand, and environment. A general guideline is described next.

First, the bearing is filled with an appropriate amount of grease. In this case, it is essential to push grease onto the cage guide surface. Then, the free space, which excludes the spindle and bearing inside the housing, is filled with an amount of grease as shown next:

1/2 to 2/3..... when the bearing speed is 50% or less of the allowable speed specified in the catalog.

1/3 to 1/2..... when the bearing speed is 50% or more.

Roughly, low speeds require more grease while high speeds require less grease. Depending on the particular application, the filling amount may have to be reduced further to reduce the torque and to prevent heat generation. When the bearing speed is extremely low, on the other hand, grease may be packed almost full to prevent dust and water entry.

Accordingly, it is necessary to know the extent of the housing's free space for the specific bearing to determine the correct filling amount. As a reference, the volume of free space is shown in Table 1 for an open type deep groove ball bearing.

Note that the free space of the open type deep groove ball bearing is the volume obtained by subtracting the volume of the balls and cage from the space formed between inner and outer rings.

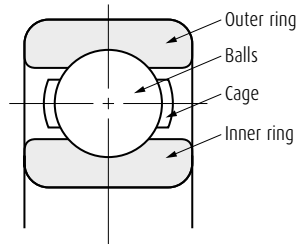

Table 1 Free Space of Open Type Deep Groove Ball Bearing

Units : cm³

Bearing bore No.	Bearing free space			Bearing bore No.	Bearing free space		
	Bearing series				Bearing series		
	60	62	63		60	62	63
00	1.2	1.5	2.9	14	34	61	148
01	1.2	2.1	3.5	15	35	67	180
02	1.6	2.7	4.8	16	47	84	213
03	2.0	3.7	6.4	17	48	104	253
04	4.0	6.0	7.9	18	63	127	297
05	4.6	7.7	12	19	66	155	345
06	6.5	11	19	20	68	184	425
07	9.2	15	25	21	88	216	475
08	11	20	35	22	114	224	555
09	14	23	49	24	122	310	675
10	15	28	64	26	172	355	830
11	22	34	79	28	180	415	1 030
12	23	45	98	30	220	485	1 140
13	24	54	122	32	285	545	1 410

Remark The table above shows the free space of a bearing using a pressed steel cage. The free space of a bearing using a high-tension brass machined cage is about 50 to 60% of the value in the table.

Single-Row Deep Groove Ball Bearings

Bore Diameter 10 – 17 mm

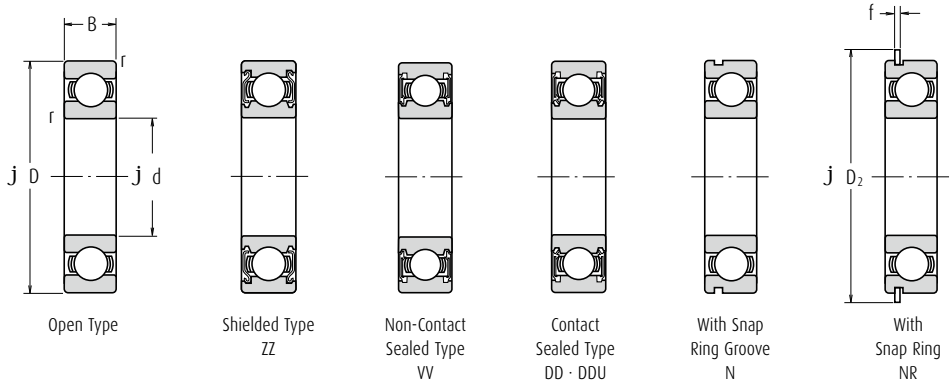

Boundary Dimensions (mm)				Basic Load Ratings (N)		Factor f_o	Limiting Speeds (min ⁻¹)			Bearing Numbers			
d	D	B	r min.	C_r	C_{or}		Grease		Oil	Open	Shielded	Sealed	
							Open Z · ZZ V · VV	DU DDU	Open Z				
10	19	5	0.3	1 720	840	14.8	34 000	24 000	40 000	6800	ZZ	VV	DD
	22	6	0.3	2 700	1 270	14.0	32 000	22 000	38 000	6900	ZZ	VV	DD
	26	8	0.3	4 550	1 970	12.4	30 000	22 000	36 000	6000	ZZ	VV	DDU
	30	9	0.6	5 100	2 390	13.2	24 000	18 000	30 000	6200	ZZ	VV	DDU
	30	9	0.6	5 350	2 390	13.2	28 000	18 000	34 000	6200 [†]	ZZ	VV	DDU
	35	11	0.6	8 100	3 450	11.2	22 000	17 000	26 000	6300	ZZ	VV	DDU
12	35	11	0.6	8 500	3 450	11.2	26 000	17 000	30 000	6300 [†]	ZZ	VV	DDU
	21	5	0.3	1 920	1 040	15.3	32 000	20 000	38 000	6801	ZZ	VV	DD
	24	6	0.3	2 890	1 460	14.5	30 000	20 000	36 000	6901	ZZ	VV	DD
	28	7	0.3	5 100	2 370	13.0	28 000	—	32 000	16001	—	—	—
	28	8	0.3	5 100	2 370	13.0	28 000	18 000	32 000	6001	ZZ	VV	DDU
	28	8	0.3	5 350	2 370	13.0	32 000	18 000	38 000	6001 [†]	ZZ	VV	DDU
15	32	10	0.6	6 800	3 050	12.3	22 000	17 000	28 000	6201	ZZ	VV	DDU
	32	10	0.6	7 150	3 050	12.3	26 000	17 000	32 000	6201 [†]	ZZ	VV	DDU
	37	12	1	9 700	4 200	11.1	20 000	16 000	24 000	6301	ZZ	VV	DDU
	37	12	1.0	10 200	4 200	11.1	24 000	16 000	28 000	6301 [†]	ZZ	VV	DDU
	24	5	0.3	2 070	1 260	15.8	28 000	17 000	34 000	6802	ZZ	VV	DD
	28	7	0.3	4 350	2 260	14.3	26 000	17 000	30 000	6902	ZZ	VV	DD
17	32	8	0.3	5 600	2 830	13.9	24 000	—	28 000	16002	—	—	—
	32	9	0.3	5 600	2 830	13.9	24 000	15 000	28 000	6002	ZZ	VV	DDU
	32	9	0.3	5 850	2 830	13.9	26 000	15 000	32 000	6002 [†]	ZZ	VV	DDU
	35	11	0.6	7 650	3 750	13.2	20 000	14 000	24 000	6202	ZZ	VV	DDU
	35	11	0.6	8 000	3 750	13.2	22 000	14 000	28 000	6202 [†]	ZZ	VV	DDU
	42	13	1	11 400	5 450	12.3	17 000	13 000	20 000	6302	ZZ	VV	DDU
17	42	13	1.0	12 000	5 450	12.3	19 000	13 000	24 000	6302 [†]	ZZ	VV	DDU
	26	5	0.3	2 630	1 570	15.7	26 000	15 000	30 000	6803	ZZ	VV	DD
	30	7	0.3	4 600	2 550	14.7	24 000	15 000	28 000	6903	ZZ	VV	DDU
	35	8	0.3	6 000	3 250	14.4	22 000	—	26 000	16003	—	—	—
	35	10	0.3	6 000	3 250	14.4	22 000	13 000	26 000	6003	ZZ	VV	DDU
	35	10	0.3	6 300	3 250	14.4	24 000	13 000	28 000	6003 [†]	ZZ	VV	DDU
40	12	0.6	9 550	4 800	13.2	17 000	12 000	20 000	6203	ZZ	VV	DDU	
	40	12	0.6	10 100	4 800	13.2	20 000	12 000	24 000	6203 [†]	ZZ	VV	DDU
	47	14	1	13 600	6 650	12.4	15 000	11 000	18 000	6303	ZZ	VV	DDU
	47	14	1.0	14 300	6 650	12.4	17 000	11 000	20 000	6303 [†]	ZZ	VV	DDU

- Notes**
- (1) For tolerances for the snap ring grooves and snap ring dimensions, refer to Pages **A116** to **A119**.
 - (2) When heavy axial loads are applied, increase d_a and decrease D_a from the above values.
 - (3) Ring types N and NR applicable only to open-type bearings. Please consult NSK about the snap ring groove dimensions of sealed or shielded bearings.
 - (4) Snap ring groove dimensions and snap ring dimensions are not conformed to ISO15.

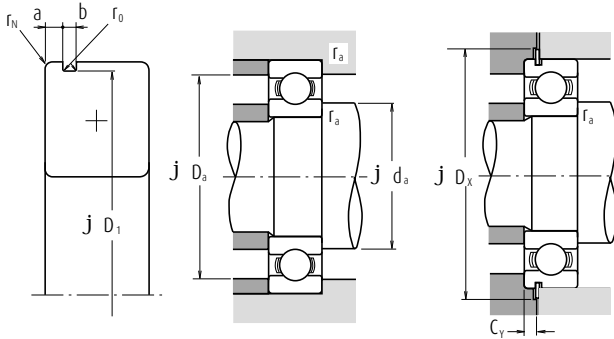

Dynamic Equivalent Load $P=XF_r+YF_a$

$\frac{f_a F_a}{C_{or}}$	e	$\frac{F_a}{F_r} \leq e$		$\frac{F_a}{F_r} > e$	
		X	Y	X	Y
0.172	0.19	1	0	0.56	2.30
0.345	0.22	1	0	0.56	1.99
0.689	0.26	1	0	0.56	1.71
1.03	0.28	1	0	0.56	1.55
1.38	0.30	1	0	0.56	1.45
2.07	0.34	1	0	0.56	1.31
3.45	0.38	1	0	0.56	1.15
5.17	0.42	1	0	0.56	1.04
6.89	0.44	1	0	0.56	1.00

Static Equivalent Load

$$\frac{F_a}{F_r} > 0.8, P_0 = 0.6F_r + 0.5F_a$$

$$\frac{F_a}{F_r} \leq 0.8, P_0 = F_r$$

With Snap Ring Groove	With Snap Ring	Snap Ring Groove Dimensions (1) (mm)					Snap Ring (1) Dimensions (mm)		Abutment and Fillet Dimensions (mm)						Mass (kg) approx.
		a max.	b min.	D ₁ max.	r ₀ max.	r _N min.	D ₂ max.	f max.	d _a (2) min.	d _a (2) max.	r _a max.	D _x min.	C _y max.		
—	—	—	—	—	—	—	—	12	12	17	0.3	—	—	0.005	
N(3)	NR(3)	1.05	0.80	20.80	0.20	0.2	24.8	0.70	12	12.5	20	0.3	25.5	1.5	0.009
N(4)	NR(4)	1.35	0.87	24.50	0.20	0.3	28.7	0.84	12	13	24	0.3	29.4	1.9	0.018
N	NR	2.06	1.35	28.17	0.40	0.5	34.7	1.12	14	16	26	0.6	35.5	2.9	0.032
—	—	—	—	—	—	—	—	—	14	16	26	0.6	—	—	0.032
N	NR	2.06	1.35	33.17	0.40	0.5	39.7	1.12	14	16.5	31	0.6	40.5	2.9	0.052
—	—	—	—	—	—	—	—	—	14	16.5	31	0.6	—	—	0.052
—	—	—	—	—	—	—	—	—	14	14	19	0.3	—	—	0.006
N(3)	NR(3)	1.05	0.80	22.80	0.20	0.2	26.8	0.70	14	14.5	22	0.3	27.5	1.5	0.010
—	—	—	—	—	—	—	—	—	14	—	26	0.3	—	—	0.019
N(4)	NR(4)	1.35	0.87	26.50	0.20	0.3	30.7	0.84	14	15.5	26	0.3	31.4	1.9	0.022
—	—	—	—	—	—	—	—	—	14	15.5	26	0.3	—	—	0.022
N	NR	2.06	1.35	30.15	0.40	0.5	36.7	1.12	16	17	28	0.6	37.5	2.9	0.037
—	—	—	—	—	—	—	—	—	16	17	28	0.6	—	—	0.037
N	NR	2.06	1.35	34.77	0.40	0.5	41.3	1.12	17	18	32	1	42	2.9	0.060
—	—	—	—	—	—	—	—	—	—	—	—	—	42	2.9	0.060
—	—	—	—	—	—	—	—	—	17	17	22	0.3	—	—	0.007
N(3)	NR(3)	1.30	0.95	26.70	0.25	0.3	30.8	0.85	17	17	26	0.3	31.5	1.8	0.015
—	—	—	—	—	—	—	—	—	17	—	30	0.3	—	—	0.027
N	NR	2.06	1.35	30.15	0.40	0.3	36.7	1.12	17	19	30	0.3	37.5	2.9	0.031
—	—	—	—	—	—	—	—	—	17	19	30	0.3	—	—	0.031
N	NR	2.06	1.35	33.17	0.40	0.5	39.7	1.12	19	20.5	31	0.6	40.5	2.9	0.045
—	—	—	—	—	—	—	—	—	19	20.5	31	0.6	—	—	0.045
N	NR	2.06	1.35	39.75	0.40	0.5	46.3	1.12	20	22.5	37	1	47	2.9	0.083
—	—	—	—	—	—	—	—	—	20	22.5	37	1	—	—	0.083
—	—	—	—	—	—	—	—	—	19	19	24	0.3	—	—	0.007
N(3)	NR(3)	1.30	0.95	28.70	0.25	0.3	32.8	0.85	19	19.5	28	0.3	33.5	1.8	0.017
—	—	—	—	—	—	—	—	—	19	—	33	0.3	—	—	0.033
N	NR	2.06	1.35	33.17	0.40	0.3	39.7	1.12	19	21.5	33	0.3	40.5	2.9	0.041
—	—	—	—	—	—	—	—	—	19	21.5	33	0.3	—	—	0.041
N	NR	2.06	1.35	38.10	0.40	0.5	44.6	1.12	21	23.5	36	0.6	45.5	2.9	0.067
—	—	—	—	—	—	—	—	—	21	23.5	36	0.6	—	—	0.067
N	NR	2.46	1.35	44.60	0.40	0.5	52.7	1.12	22	25.5	42	1	53.5	3.3	0.113
—	—	—	—	—	—	—	—	—	22	25.5	42	1	—	—	0.113

- Remarks**
1. Diameter Series 7 (extra thin section bearings) are also available, please contact NSK.
 2. When using bearings with rotating outer rings, contact NSK if they are sealed, shielded, or have snap rings.
 3. The bearings denoted by an asterisk(*) are NSKHPS Deep groove ball bearings.

Single-Row Deep Groove Ball Bearings

Bore Diameter 20 - 30 mm

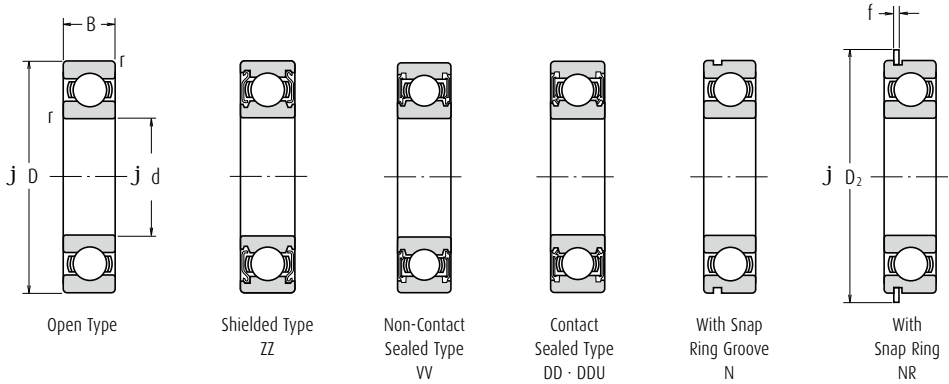

Boundary Dimensions (mm)				Basic Load Ratings (N)		Factor f_o	Limiting Speeds (min ⁻¹)			Bearing Numbers			
d	D	B	r min.	C_r	C_{or}		Grease		Oil	Open	Shielded	Sealed	
							Open Z · ZZ V · VV	DU DDU	Open Z				
20	32	7	0.3	4 000	2 470	15.5	22 000	13 000	26 000	6804	ZZ	VV	DD
	37	9	0.3	6 400	3 700	14.7	19 000	12 000	22 000	6904	ZZ	VV	DDU
	42	8	0.3	7 900	4 450	14.5	18 000	—	20 000	16004	—	—	—
	42	12	0.6	9 400	5 000	13.8	18 000	11 000	20 000	6004	ZZ	VV	DDU
	42	12	0.6	9 850	5 000	13.8	20 000	11 000	24 000	6004 [†]	ZZ	VV	DDU
	47	14	1	12 800	6 600	13.1	15 000	11 000	18 000	6204	ZZ	VV	DDU
	47	14	1.0	13 400	6 600	13.1	17 000	11 000	20 000	6204 [†]	ZZ	VV	DDU
	52	15	1.1	15 900	7 900	12.4	14 000	10 000	17 000	6304	ZZ	VV	DDU
	52	15	1.1	16 700	7 900	12.4	16 000	10 000	19 000	6304 [†]	ZZ	VV	DDU
	22	44	12	0.6	9 400	5 050	14.0	17 000	11 000	20 000	60/22	ZZ	VV
25	50	14	1	12 900	6 800	13.5	14 000	9 500	16 000	62/22	ZZ	VV	DDU
	56	16	1.1	18 400	9 250	12.4	13 000	9 500	16 000	63/22	ZZ	VV	DDU
	37	7	0.3	4 500	3 150	16.1	18 000	10 000	22 000	6805	ZZ	VV	DD
	42	9	0.3	7 050	4 550	15.4	16 000	10 000	19 000	6905	ZZ	VV	DDU
	47	8	0.3	8 850	5 600	15.1	15 000	—	18 000	16005	—	—	—
	47	12	0.6	10 100	5 850	14.5	15 000	9 500	18 000	6005	ZZ	VV	DDU
	47	12	0.6	10 600	5 850	14.5	18 000	9 500	22 000	6005 [†]	ZZ	VV	DDU
	52	15	1	14 000	7 850	13.9	13 000	9 000	15 000	6205	ZZ	VV	DDU
	52	15	1.0	14 700	7 850	13.9	15 000	9 000	18 000	6205 [†]	ZZ	VV	DDU
	62	17	1.1	20 600	11 200	13.2	11 000	8 000	13 000	6305	ZZ	VV	DDU
28	62	17	1.1	21 600	11 200	13.2	13 000	8 000	16 000	6305 [†]	ZZ	VV	DDU
	52	12	0.6	12 500	7 400	14.5	14 000	8 500	16 000	60/28	ZZ	VV	DDU
	58	16	1	16 600	9 500	13.9	12 000	8 000	14 000	62/28	ZZ	VV	DDU
	68	18	1.1	26 700	14 000	12.4	10 000	7 500	13 000	63/28	ZZ	VV	DDU
	42	7	0.3	4 700	3 650	16.4	15 000	9 000	18 000	6806	ZZ	VV	DD
	47	9	0.3	7 250	5 000	15.8	14 000	8 500	17 000	6906	ZZ	VV	DDU
	55	9	0.3	11 200	7 350	15.2	13 000	—	15 000	16006	—	—	—
	55	13	1	13 200	8 300	14.7	13 000	8 000	15 000	6006	ZZ	VV	DDU
	55	13	1.0	13 900	8 300	14.7	15 000	8 000	18 000	6006 [†]	ZZ	VV	DDU
	62	16	1	19 500	11 300	13.8	11 000	7 500	13 000	6206	ZZ	VV	DDU
30	62	16	1.0	20 400	11 300	13.8	12 000	7 500	15 000	6206 [†]	ZZ	VV	DDU
	72	19	1.1	26 700	15 000	13.3	9 500	6 700	12 000	6306	ZZ	VV	DDU
	72	19	1.1	28 000	15 000	13.3	11 000	6 700	13 000	6306 [†]	ZZ	VV	DDU

Notes (1) For tolerances for the snap ring grooves and snap ring dimensions, refer to Pages **A116** to **A119**.

(2) When heavy axial loads are applied, increase d_a and decrease D_a from the above values.

(3) Ring types N and NR applicable only to open-type bearings. Please consult NSK about the snap ring groove dimensions of sealed or shielded bearings.

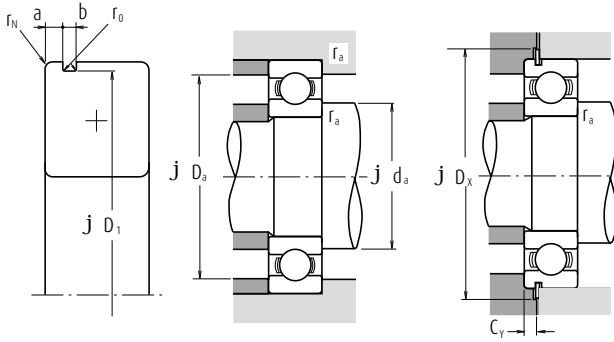

Dynamic Equivalent Load $P=XF_r+YF_a$

$\frac{f_r F_a}{C_{or}}$	e	$\frac{F_a}{F_r} \leq e$		$\frac{F_a}{F_r} > e$	
		X	Y	X	Y
0.172	0.19	1	0	0.56	2.30
0.345	0.22	1	0	0.56	1.99
0.689	0.26	1	0	0.56	1.71
1.03	0.28	1	0	0.56	1.55
1.38	0.30	1	0	0.56	1.45
2.07	0.34	1	0	0.56	1.31
3.45	0.38	1	0	0.56	1.15
5.17	0.42	1	0	0.56	1.04
6.89	0.44	1	0	0.56	1.00

Static Equivalent Load

$$\frac{F_a}{F_r} > 0.8, P_0 = 0.6F_r + 0.5F_a$$

$$\frac{F_a}{F_r} \leq 0.8, P_0 = F_r$$

With Snap Ring Groove	With Snap Ring	Snap Ring Groove Dimensions (1) (mm)					Snap Ring (1) Dimensions (mm)		Abutment and Fillet Dimensions (mm)						Mass (kg) approx.
		a max.	b min.	D ₁ max.	r ₀ max.	r _N min.	D ₂ max.	f max.	d _a (2) min.	d _a (2) max.	D _a (2) max.	r _a max.	D _x min.	C _y max.	
N	NR	1.30	0.95	30.70	0.25	0.3	34.8	0.85	22	22	30	0.3	35.5	1.8	0.017
N	NR	1.70	0.95	35.70	0.25	0.3	39.8	0.85	22	24	35	0.3	40.5	2.3	0.037
—	—	—	—	—	—	—	—	—	22	—	40	0.3	—	—	0.048
N	NR	2.06	1.35	39.75	0.40	0.5	46.3	1.12	24	25.5	38	0.6	47	2.9	0.068
—	—	—	—	—	—	—	—	—	24	25.5	38	0.6	—	—	0.068
N	NR	2.46	1.35	44.60	0.40	0.5	52.7	1.12	25	26.5	42	1	53.5	3.3	0.107
—	—	—	—	—	—	—	—	—	25	26.5	42	1	—	—	0.107
N	NR	2.46	1.35	49.73	0.40	0.5	57.9	1.12	26.5	28	45.5	1	58.5	3.3	0.145
—	—	—	—	—	—	—	—	—	26.5	28	45.5	1	—	—	0.145
N	NR	2.06	1.35	41.75	0.40	0.5	48.3	1.12	26	26.5	40	0.6	49	2.9	0.074
N	NR	2.46	1.35	47.60	0.40	0.5	55.7	1.12	27	29.5	45	1	56.5	3.3	0.119
N	NR	2.46	1.35	53.60	0.40	0.5	61.7	1.12	28.5	30.5	49.5	1	62.5	3.3	0.179
N	NR	1.30	0.95	35.70	0.25	0.3	39.8	0.85	27	27	35	0.3	40.5	1.8	0.021
N(*)	NR(*)	1.70	0.95	40.70	0.25	0.3	44.8	0.85	27	28.5	40	0.3	45.5	2.3	0.042
—	—	—	—	—	—	—	—	—	27	—	45	0.3	—	—	0.059
N	NR	2.06	1.35	44.60	0.40	0.5	52.7	1.12	29	30	43	0.6	53.5	2.9	0.079
—	—	—	—	—	—	—	—	—	29	30	43	0.6	—	—	0.079
N	NR	2.46	1.35	49.73	0.40	0.5	57.9	1.12	30	32	47	1	58.5	3.3	0.129
—	—	—	—	—	—	—	—	—	30	32	47	1	—	—	0.129
N	NR	3.28	1.90	59.61	0.60	0.5	67.7	1.70	31.5	36	55.5	1	68.5	4.6	0.235
—	—	—	—	—	—	—	—	—	31.5	36	55.5	1	—	—	0.235
N	NR	2.06	1.35	49.73	0.40	0.5	57.9	1.12	32	34	48	0.6	58.5	2.9	0.096
N	NR	2.46	1.35	55.60	0.40	0.5	63.7	1.12	33	35.5	53	1	64.5	3.3	0.175
N	NR	3.28	1.90	64.82	0.60	0.5	74.6	1.70	34.5	38	61.5	1	76	4.6	0.287
N	NR	1.30	0.95	40.70	0.25	0.3	44.8	0.85	32	32	40	0.3	45.5	1.8	0.024
N	NR	1.70	0.95	45.70	0.25	0.3	49.8	0.85	32	34	45	0.3	50.5	2.3	0.052
—	—	—	—	—	—	—	—	—	32	—	53	0.3	—	—	0.087
N	NR	2.08	1.35	52.60	0.40	0.5	60.7	1.12	35	36.5	50	1	61.5	2.9	0.116
—	—	—	—	—	—	—	—	—	35	36.5	50	1	—	—	0.116
N	NR	3.28	1.90	59.61	0.60	0.5	67.7	1.70	35	38.5	57	1	68.5	4.6	0.199
—	—	—	—	—	—	—	—	—	35	38.5	57	1	—	—	0.199
N	NR	3.28	1.90	68.81	0.60	0.5	78.6	1.70	36.5	42.5	65.5	1	80	4.6	0.345
—	—	—	—	—	—	—	—	—	36.5	42.5	65.5	1	—	—	0.345

- Remarks**
1. Diameter Series 7 (extra thin section bearings) are also available, please contact NSK.
 2. When using bearings with rotating outer rings, contact NSK if they are sealed, shielded, or have snap rings.
 3. The bearings denoted by an asterisk(*) are NSKHPS Deep groove ball bearings.

Single-Row Deep Groove Ball Bearings

Bore Diameter 32 – 45 mm

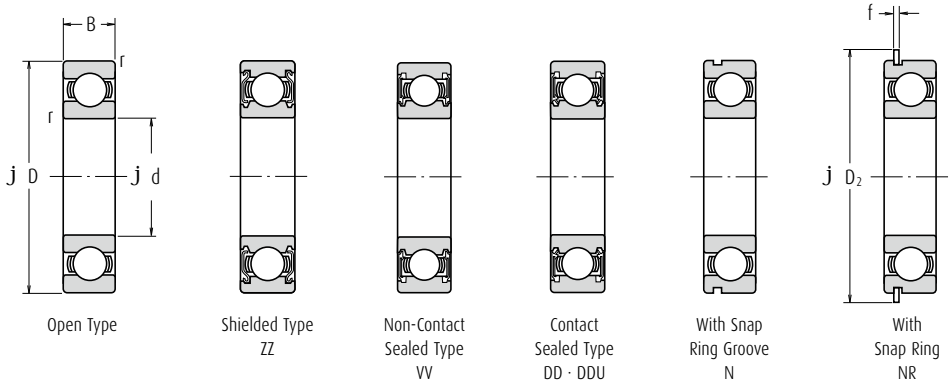

Boundary Dimensions (mm)				Basic Load Ratings (N)		Factor f_o	Limiting Speeds (min ⁻¹)			Bearing Numbers			
d	D	B	r min.	C_r	C_{or}		Grease		Oil	Open	Shielded	Sealed	
							Open Z · ZZ V · VV	DU DDU	Open Z				
32	58	13	1	15 100	9 150	14.5	12 000	7 500	14 000	60/32	ZZ	VV	DDU
	65	17	1	20 700	11 600	13.6	10 000	7 100	12 000	62/32	ZZ	VV	DDU
	75	20	1.1	29 900	17 000	13.2	9 000	6 300	11 000	63/32	ZZ	VV	DDU
35	47	7	0.3	4 900	4 100	16.7	14 000	7 500	16 000	6807	ZZ	VV	DD
	55	10	0.6	10 600	7 250	15.5	12 000	7 500	15 000	6907	ZZ	VV	DDU
	62	9	0.3	11 700	8 200	15.6	11 000	—	13 000	16007	—	—	—
	62	14	1	16 000	10 300	14.8	11 000	6 700	13 000	6007	ZZ	VV	DDU
	62	14	1.0	16 800	10 300	14.8	13 000	6 700	15 000	6007 [†]	ZZ	VV	DDU
	72	17	1.1	25 700	15 300	13.8	9 500	6 300	11 000	6207	ZZ	VV	DDU
	72	17	1.1	27 000	15 300	13.8	11 000	6 300	13 000	6207 [†]	ZZ	VV	DDU
40	80	21	1.5	33 500	19 200	13.2	8 500	6 000	10 000	6307	ZZ	VV	DDU
	80	21	1.5	35 000	19 200	13.2	10 000	6 000	12 000	6307 [†]	ZZ	VV	DDU
	52	7	0.3	6 350	5 550	17.0	12 000	6 700	14 000	6808	ZZ	VV	DD
	62	12	0.6	13 700	10 000	15.7	11 000	6 300	13 000	6908	ZZ	VV	DDU
	68	9	0.3	12 600	9 650	16.0	10 000	—	12 000	16008	—	—	—
	68	15	1	16 800	11 500	15.3	10 000	6 000	12 000	6008	ZZ	VV	DDU
	68	15	1.0	17 600	11 500	15.3	12 000	6 000	14 000	6008 [†]	ZZ	VV	DDU
45	80	18	1.1	29 100	17 900	14.0	8 500	5 600	10 000	6208	ZZ	VV	DDU
	80	18	1.1	30 500	17 900	14.0	9 500	5 600	12 000	6208 [†]	ZZ	VV	DDU
	90	23	1.5	40 500	24 000	13.2	7 500	5 300	9 000	6308	ZZ	VV	DDU
	90	23	1.5	43 000	24 000	13.2	9 000	5 300	11 000	6308 [†]	ZZ	VV	DDU
	58	7	0.3	6 600	6 150	17.2	11 000	6 000	13 000	6809	ZZ	VV	DD
	68	12	0.6	14 100	10 900	15.9	9 500	5 600	12 000	6909	ZZ	VV	DDU
	75	10	0.6	14 900	11 400	15.9	9 000	—	11 000	16009	—	—	—
50	75	16	1	20 900	15 200	15.3	9 000	5 300	11 000	6009	ZZ	VV	DDU
	75	16	1.0	22 000	15 200	15.3	10 000	5 300	12 000	6009 [†]	ZZ	VV	DDU
	85	19	1.1	31 500	20 400	14.4	7 500	5 300	9 000	6209	ZZ	VV	DDU
	85	19	1.1	33 000	20 400	14.4	9 000	5 300	11 000	6209 [†]	ZZ	VV	DDU
	100	25	1.5	53 000	32 000	13.1	6 700	4 800	8 000	6309	ZZ	VV	DDU
	100	25	1.5	55 500	32 000	13.1	7 500	4 800	9 500	6309 [†]	ZZ	VV	DDU

Notes (1) For tolerances for the snap ring grooves and snap ring dimensions, refer to Pages **A116** to **A119**.

(2) When heavy axial loads are applied, increase d_a and decrease D_a from the above values.

(3) Snap ring groove dimensions and snap ring dimensions are not conformed to ISO15.

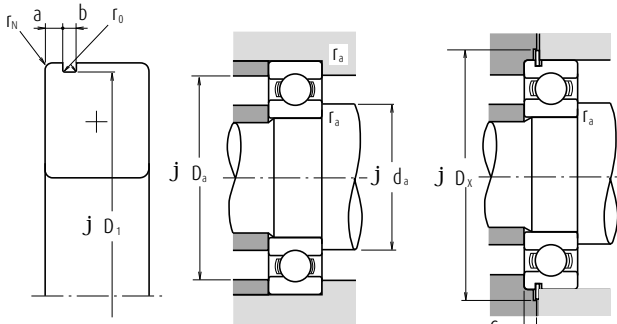

Dynamic Equivalent Load $P=XF_r+YF_a$

$\frac{f_a F_a}{C_{or}}$	e	$\frac{F_a}{F_r} \leq e$		$\frac{F_a}{F_r} > e$	
		X	Y	X	Y
0.172	0.19	1	0	0.56	2.30
0.345	0.22	1	0	0.56	1.99
0.689	0.26	1	0	0.56	1.71
1.03	0.28	1	0	0.56	1.55
1.38	0.30	1	0	0.56	1.45
2.07	0.34	1	0	0.56	1.31
3.45	0.38	1	0	0.56	1.15
5.17	0.42	1	0	0.56	1.04
6.89	0.44	1	0	0.56	1.00

Static Equivalent Load

$$\frac{F_a}{F_r} > 0.8, P_0 = 0.6F_r + 0.5F_a$$

$$\frac{F_a}{F_r} \leq 0.8, P_0 = F_r$$

With Snap Ring Groove	With Snap Ring	Snap Ring Groove Dimensions (1) (mm)					Snap Ring (1) Dimensions (mm)		Abutment and Fillet Dimensions (mm)						Mass (kg) approx.
		a max.	b min.	D ₁ max.	r ₀ max.	r _N min.	D ₂ max.	f max.	d _a (2) min.	d _a (2) max.	D _a (2) max.	r _a max.	D _x min.	C _y max.	
N	NR	2.08	1.35	55.60	0.40	0.5	63.7	1.12	37	38.5	53	1	64.5	2.9	0.122
N	NR	3.28	1.90	62.60	0.60	0.5	70.7	1.70	37	40	60	1	71.5	4.6	0.225
N	NR	3.28	1.90	71.83	0.60	0.5	81.6	1.70	38.5	44.5	68.5	1	83	4.6	0.389
N	NR	1.30	0.95	45.70	0.25	0.3	49.8	0.85	37	37	45	0.3	50.5	1.8	0.027
N	NR	1.70	0.95	53.70	0.25	0.5	57.8	0.85	39	39	51	0.6	58.5	2.3	0.075
—	—	—	—	—	—	—	—	—	37	—	60	0.3	—	—	0.107
N	NR	2.08	1.90	59.61	0.60	0.5	67.7	1.70	40	41.5	57	1	68.5	3.4	0.151
N	—	—	—	—	—	—	—	—	40	41.5	57	1	—	—	0.151
N	NR	3.28	1.90	68.81	0.60	0.5	78.6	1.70	41.5	44.5	65.5	1	80	4.6	0.284
—	—	—	—	—	—	—	—	—	41.5	44.5	65.5	1	—	—	0.284
N	NR	3.28	1.90	76.81	0.60	0.5	86.6	1.70	43	47	72	1.5	88	4.6	0.464
—	—	—	—	—	—	—	—	—	43	47	72	1.5	—	—	0.464
N	NR	1.30	0.95	50.70	0.25	0.3	54.8	0.85	42	42	50	0.3	55.5	1.8	0.031
N	NR	1.70	0.95	60.70	0.25	0.5	64.8	0.85	44	46	58	0.6	65.5	2.3	0.112
—	—	—	—	—	—	—	—	—	42	—	66	0.3	—	—	0.13
N	NR	2.49	1.90	64.82	0.60	0.5	74.6	1.70	45	47.5	63	1	76	3.8	0.19
—	—	—	—	—	—	—	—	—	45	47.5	63	1	—	—	0.19
N	NR	3.28	1.90	76.81	0.60	0.5	86.6	1.70	46.5	50.5	73.5	1	88	4.6	0.366
—	—	—	—	—	—	—	—	—	46.5	50.5	73.5	1	—	—	0.366
N	NR	3.28	2.70	86.79	0.60	0.5	96.5	2.46	48	53	82	1.5	98	5.4	0.636
—	—	—	—	—	—	—	—	—	48	53	82	1.5	—	—	0.636
N	NR	1.30	0.95	56.70	0.25	0.3	60.8	0.85	47	47.5	56	0.3	61.5	1.8	0.038
N	NR	1.70	0.95	66.70	0.25	0.3	70.8	0.85	49	50	64	0.6	72	2.3	0.126
—	—	—	—	—	—	—	—	—	49	—	71	0.6	—	—	0.167
N	NR	2.49	1.90	71.83	0.60	0.5	81.6	1.70	50	53.5	70	1	83	3.8	0.241
—	—	—	—	—	—	—	—	—	50	53.5	70	1	—	—	0.241
N	NR	3.28	1.90	81.81	0.60	0.5	91.6	1.70	51.5	55.5	78.5	1	93	4.6	0.42
—	—	—	—	—	—	—	—	—	51.5	55.5	78.5	1	—	—	0.42
N	NR	3.28	2.70	96.80	0.60	0.5	106.50	2.46	53	61.5	92	1.5	108	5.4	0.829
—	—	—	—	—	—	—	—	—	53	61.5	92	1.5	—	—	0.829

- Remarks**
1. Diameter Series 7 (extra thin section bearings) are also available, please contact NSK.
 2. When using bearings with rotating outer rings, contact NSK if they are sealed, shielded, or have snap rings.
 3. The bearings denoted by an asterisk(*) are NSKHPS Deep groove ball bearings.

Single-Row Deep Groove Ball Bearings

Bore Diameter 50 – 60 mm

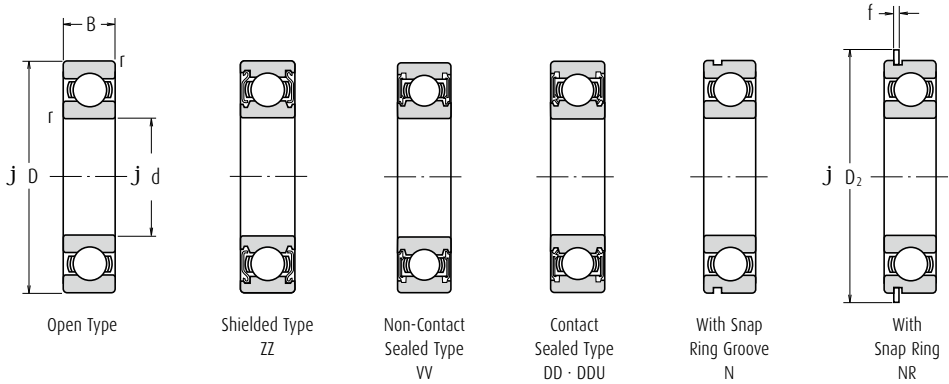

Boundary Dimensions (mm)				Basic Load Ratings (N)		Factor f_o	Limiting Speeds (min ⁻¹)			Bearing Numbers			
d	D	B	r min.	C_r	C_{or}		Grease		Oil	Open	Shielded	Sealed	
							Open Z · ZZ V · VV	DU DDU	Open Z				
50	65	7	0.3	6 400	6 200	17.2	9 500	5 300	11 000	6810	ZZ	VV	DDU
	72	12	0.6	14 500	11 700	16.1	9 000	5 300	11 000	6910	ZZ	VV	DDU
	80	10	0.6	15 400	12 400	16.1	8 500	—	10 000	16010	—	—	—
	80	16	1	21 800	16 600	15.6	8 500	4 800	10 000	6010	ZZ	VV	DDU
	80	16	1.0	22 900	16 600	15.6	9 500	4 800	11 000	6010 ¹⁾	ZZ	VV	DDU
	90	20	1.1	35 000	23 200	14.4	7 100	4 800	8 500	6210	ZZ	VV	DDU
	90	20	1.1	37 000	23 200	14.4	8 500	4 800	10 000	6210 ²⁾	ZZ	VV	DDU
	110	27	2	62 000	38 500	13.2	6 000	4 300	7 500	6310	ZZ	VV	DDU
	110	27	2.0	65 000	38 500	13.2	7 100	4 300	8 500	6310 ²⁾	ZZ	VV	DDU
	55	72	9	0.3	8 800	8 500	17.0	8 500	4 800	10 000	6811	ZZ	VV
80		13	1	16 000	13 300	16.2	8 000	4 500	9 500	6911	ZZ	VV	DDU
90		11	0.6	19 400	16 300	16.2	7 500	—	9 000	16011	—	—	—
90		18	1.1	28 300	21 200	15.3	7 500	4 500	9 000	6011	ZZ	VV	DDU
90		18	1.1	29 700	21 200	15.3	8 500	4 500	10 000	6011 ²⁾	ZZ	VV	DDU
100		21	1.5	43 500	29 300	14.3	6 300	4 300	7 500	6211	ZZ	VV	DDU
100		21	1.5	45 500	29 300	14.3	7 500	4 300	9 000	6211 ²⁾	ZZ	VV	DDU
120		29	2	71 500	44 500	13.1	5 600	4 000	6 700	6311	ZZ	VV	DDU
120		29	2.0	75 000	44 500	13.1	6 700	4 000	8 000	6311 ²⁾	ZZ	VV	DDU
60		78	10	0.3	11 500	10 900	16.9	8 000	4 500	9 500	6812	ZZ	VV
	85	13	1	19 400	16 300	16.2	7 500	4 300	9 000	6912	ZZ	VV	DDU
	95	11	0.6	20 000	17 500	16.3	7 100	—	8 500	16012	—	—	—
	95	18	1.1	29 500	23 200	15.6	7 100	4 000	8 500	6012	ZZ	VV	DDU
	95	18	1.1	31 000	23 200	15.6	8 000	4 000	9 500	6012 ²⁾	ZZ	VV	DDU
	110	22	1.5	52 500	36 000	14.3	5 600	3 800	7 100	6212	ZZ	VV	DDU
	110	22	1.5	55 000	36 000	14.3	6 700	3 800	8 000	6212 ²⁾	ZZ	VV	DDU
	130	31	2.1	82 000	52 000	13.1	5 300	3 600	6 300	6312	ZZ	VV	DDU
	130	31	2.1	86 000	52 000	13.1	6 000	3 600	7 100	6312 ²⁾	ZZ	VV	DDU

- Notes** (1) For tolerances for the snap ring grooves and snap ring dimensions, refer to Pages **A116** to **A119**.
 (2) When heavy axial loads are applied, increase d_a and decrease D_a from the above values.

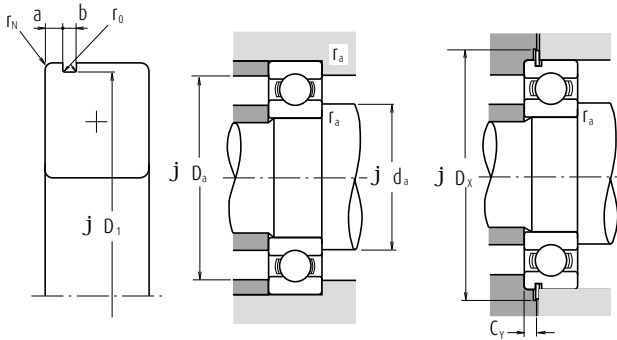

Dynamic Equivalent Load $P=XF_r+YF_a$

$\frac{f_a F_a}{C_{or}}$	e	$\frac{F_a}{F_r} \leq e$		$\frac{F_a}{F_r} > e$	
		X	Y	X	Y
0.172	0.19	1	0	0.56	2.30
0.345	0.22	1	0	0.56	1.99
0.689	0.26	1	0	0.56	1.71
1.03	0.28	1	0	0.56	1.55
1.38	0.30	1	0	0.56	1.45
2.07	0.34	1	0	0.56	1.31
3.45	0.38	1	0	0.56	1.15
5.17	0.42	1	0	0.56	1.04
6.89	0.44	1	0	0.56	1.00

Static Equivalent Load

$$\frac{F_a}{F_r} > 0.8, P_0 = 0.6F_r + 0.5F_a$$

$$\frac{F_a}{F_r} \leq 0.8, P_0 = F_r$$

With Snap Ring Groove	With Snap Ring	Snap Ring Groove Dimensions (1) (mm)					Snap Ring (1) Dimensions (mm)		Abutment and Fillet Dimensions (mm)						Mass (kg) approx.
		a max.	b min.	D ₁ max.	r ₀ max.	r _N min.	D ₂ max.	f max.	d _a (2) min.	d _a (2) max.	D _a (2) max.	r _a max.	D _x min.	C _y max.	
N	NR	1.30	0.95	63.7	0.25	0.3	67.8	0.85	52	52.5	63	0.3	68.5	1.8	0.050
N	NR	1.70	0.95	70.7	0.25	0.5	74.8	0.85	54	55	68	0.6	76	2.3	0.135
—	—	—	—	—	—	—	—	—	54	—	76	0.6	—	—	0.175
N	NR	2.49	1.90	76.81	0.60	0.5	86.6	1.70	55	58.5	75	1	88	3.8	0.261
—	—	—	—	—	—	—	—	—	55	58.5	75	1	—	—	0.261
N	NR	3.28	2.70	86.79	0.60	0.5	96.5	2.46	56.5	60	83.5	1	98	5.4	0.459
—	—	—	—	—	—	—	—	—	56.5	60	83.5	1	—	—	0.459
N	NR	3.28	2.70	106.81	0.60	0.5	116.6	2.46	59	68	101	2	118	5.4	1.06
—	—	—	—	—	—	—	—	—	59	68	101	2	—	—	1.06
N	NR	1.70	0.95	70.7	0.25	0.3	74.8	0.85	57	59	70	0.3	76	2.3	0.081
N	NR	2.10	1.30	77.9	0.40	0.5	84.4	1.12	60	61.5	75	1	86	2.9	0.189
—	—	—	—	—	—	—	—	—	59	—	86	0.6	—	—	0.257
N	NR	2.87	2.70	86.79	0.60	0.5	96.5	2.46	61.5	64	83.5	1	98	5.0	0.381
—	—	—	—	—	—	—	—	—	61.5	64	83.5	1	—	—	0.381
N	NR	3.28	2.70	96.8	0.60	0.5	106.5	2.46	63	66.5	92	1.5	108	5.4	0.619
—	—	—	—	—	—	—	—	—	63	66.5	92	1.5	—	—	0.619
N	NR	4.06	3.10	115.21	0.60	0.5	129.7	2.82	64	72.5	111	2	131.5	6.5	1.37
—	—	—	—	—	—	—	—	—	64	72.5	111	2	—	—	1.37
N	NR	1.70	1.30	76.2	0.40	0.3	82.7	1.12	62	64	76	0.3	84	2.5	0.103
N	NR	2.10	1.30	82.9	0.40	0.5	89.4	1.12	65	66	80	1	91	2.9	0.192
—	—	—	—	—	—	—	—	—	64	—	91	0.6	—	—	0.281
N	NR	2.87	2.70	91.82	0.60	0.5	101.6	2.46	66.5	69	88.5	1	103	5.0	0.412
—	—	—	—	—	—	—	—	—	66.5	69	88.5	1	—	—	0.412
N	NR	3.28	2.70	106.81	0.60	0.5	116.6	2.46	68	74.5	102	1.5	118	5.4	0.783
—	—	—	—	—	—	—	—	—	68	74.5	102	1.5	—	—	0.783
N	NR	4.06	3.10	125.22	0.60	0.5	139.7	2.82	71	79	119	2	141.5	6.5	1.72
—	—	—	—	—	—	—	—	—	71	79	119	2	—	—	1.72

- Remarks**
1. Diameter Series 7 (extra thin section bearings) are also available, please contact NSK.
 2. When using bearings with rotating outer rings, contact NSK if they are sealed, shielded, or have snap rings.
 3. Please consult NSK about the snap ring groove dimensions of sealed and shielded bearings when the diameter of dimension series 18 and 19 is 50 mm or more.
 4. The bearings denoted by an asterisk(*) are NSKHS Deep groove ball bearings.

Single-Row Deep Groove Ball Bearings

Bore Diameter 65 – 75 mm

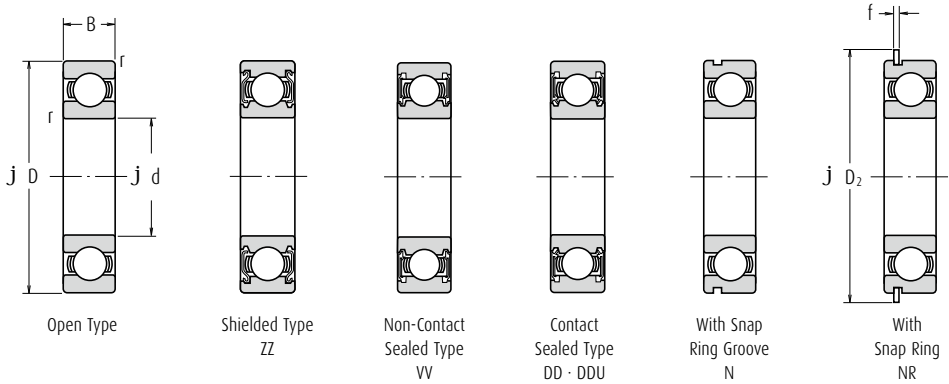

Boundary Dimensions (mm)				Basic Load Ratings (N)		Factor f_o	Limiting Speeds (min ⁻¹)			Bearing Numbers			
d	D	B	r min.	C_r	C_{or}		Grease		Oil	Open	Shielded	Sealed	
							Open Z · ZZ V · VV	DU DDU	Open Z				
65	85	10	0.6	11 900	12 100	17.0	7 500	4 000	8 500	6813	ZZ	VV	DD
	90	13	1	17 400	16 100	16.6	7 100	4 000	8 500	6913	ZZ	VV	DDU
	100	11	0.6	20 500	18 700	16.5	6 700	—	8 000	16013	—	—	—
	100	18	1.1	30 500	25 200	15.8	6 700	4 000	8 000	6013	ZZ	VV	DDU
	100	18	1.1	32 000	25 200	15.8	7 500	4 000	9 000	6013 ^a	ZZ	VV	DDU
	120	23	1.5	57 500	40 000	14.4	5 300	3 600	6 300	6213	ZZ	VV	DDU
	120	23	1.5	60 000	40 000	14.4	6 300	3 600	7 500	6213 ^a	ZZ	VV	DDU
	140	33	2.1	92 500	60 000	13.2	4 800	3 400	6 000	6313	ZZ	VV	DDU
	140	33	2.1	97 500	60 000	13.2	5 600	3 400	6 700	6313 ^a	ZZ	VV	DDU
	70	90	10	0.6	12 100	12 700	17.2	6 700	3 800	8 000	6814	ZZ	VV
100		16	1	23 700	21 200	16.3	6 300	3 600	7 500	6914	ZZ	VV	DDU
110		13	0.6	26 800	23 600	16.3	6 000	—	7 100	16014	—	—	—
110		20	1.1	38 000	31 000	15.6	6 000	3 600	7 100	6014	ZZ	VV	DDU
110		20	1.1	40 000	31 000	15.6	7 100	3 600	8 500	6014 ^a	ZZ	VV	DDU
125		24	1.5	62 000	44 000	14.5	5 000	3 400	6 300	6214	ZZ	VV	DDU
125		24	1.5	65 500	44 000	14.5	6 000	3 400	7 100	6214 ^a	ZZ	VV	DDU
150		35	2.1	104 000	68 000	13.2	4 500	3 200	5 300	6314	ZZ	VV	DDU
150		35	2.1	109 000	68 000	13.2	5 300	3 200	6 300	6314 ^a	ZZ	VV	DDU
75		95	10	0.6	12 500	13 900	17.3	6 300	3 600	7 500	6815	ZZ	VV
	105	16	1	24 400	22 600	16.5	6 000	3 400	7 100	6915	ZZ	VV	DDU
	115	13	0.6	27 600	25 300	16.4	5 600	—	6 700	16015	—	—	—
	115	20	1.1	39 500	33 500	15.8	5 600	3 400	6 700	6015	ZZ	VV	DDU
	115	20	1.1	41 500	33 500	15.8	6 700	3 400	8 000	6015 ^a	ZZ	VV	DDU
	130	25	1.5	66 000	49 500	14.7	4 800	3 200	5 600	6215	ZZ	VV	DDU
	130	25	1.5	69 500	49 500	14.7	5 600	3 200	6 700	6215 ^a	ZZ	VV	DDU
	160	37	2.1	113 000	77 000	13.2	4 300	2 800	5 000	6315	ZZ	VV	DDU
	160	37	2.1	119 000	77 000	13.2	4 800	2 800	6 000	6315 ^a	ZZ	VV	DDU

- Notes** (1) For tolerances for the snap ring grooves and snap ring dimensions, refer to Pages **A116** to **A119**.
 (2) When heavy axial loads are applied, increase d_a and decrease D_a from the above values.

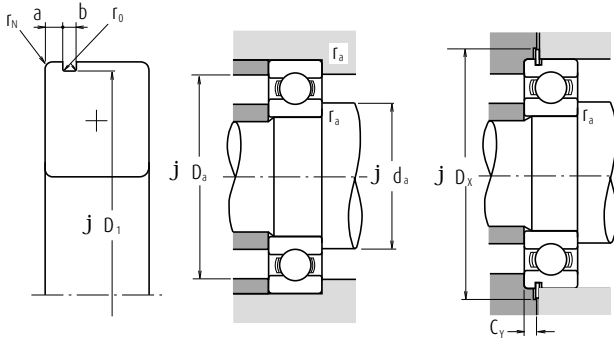

Dynamic Equivalent Load $P=XF_r+YF_a$

$\frac{f_a F_a}{C_{or}}$	e	$\frac{F_a}{F_r} \leq e$		$\frac{F_a}{F_r} > e$	
		X	Y	X	Y
0.172	0.19	1	0	0.56	2.30
0.345	0.22	1	0	0.56	1.99
0.689	0.26	1	0	0.56	1.71
1.03	0.28	1	0	0.56	1.55
1.38	0.30	1	0	0.56	1.45
2.07	0.34	1	0	0.56	1.31
3.45	0.38	1	0	0.56	1.15
5.17	0.42	1	0	0.56	1.04
6.89	0.44	1	0	0.56	1.00

Static Equivalent Load

$$\frac{F_a}{F_r} > 0.8, P_0 = 0.6F_r + 0.5F_a$$

$$\frac{F_a}{F_r} \leq 0.8, P_0 = F_r$$

With Snap Ring Groove	With Snap Ring	Snap Ring Groove Dimensions (1) (mm)					Snap Ring (1) Dimensions (mm)		Abutment and Fillet Dimensions (mm)						Mass (kg) approx.
		a max.	b min.	D ₁ max.	r ₀ max.	r _N min.	D ₂ max.	f max.	d _a (2) min.	d _a (2) max.	D _a (2) max.	r _a max.	D _x min.	C _y max.	
N	NR	1.70	1.30	82.9	0.40	0.5	89.4	1.12	69	69	81	0.6	91	2.5	0.128
N	NR	2.10	1.30	87.9	0.40	0.5	94.4	1.12	70	71.5	85	1	96	2.9	0.218
—	—	—	—	—	—	—	—	—	69	—	96	0.6	—	—	0.30
N	NR	2.87	2.70	96.8	0.60	0.5	106.5	2.46	71.5	73	93.5	1	108	5.0	0.439
—	—	—	—	—	—	—	—	—	71.5	73	93.5	1	—	—	0.439
N	NR	4.06	3.10	115.21	0.60	0.5	129.7	2.82	73	80	112	1.5	131.5	6.5	1.0
—	—	—	—	—	—	—	—	—	73	80	112	1.5	—	—	1.0
N	NR	4.90	3.10	135.23	0.60	0.5	149.7	2.82	76	85.5	129	2	152	7.3	2.11
—	—	—	—	—	—	—	—	—	76	85.5	129	2	—	—	2.11
N	NR	1.70	1.30	87.9	0.40	0.5	94.4	1.12	74	74.5	86	0.6	96	2.5	0.134
N	NR	2.50	1.30	97.9	0.40	0.5	104.4	1.12	75	77.5	95	1	106	3.3	0.349
—	—	—	—	—	—	—	—	—	74	—	106	0.6	—	—	0.441
N	NR	2.87	2.70	106.81	0.60	0.5	116.6	2.46	76.5	80.5	103.5	1	118	5.0	0.608
—	—	—	—	—	—	—	—	—	76.5	80.5	103.5	1	—	—	0.608
N	NR	4.06	3.10	120.22	0.60	0.5	134.7	2.82	78	84	117	1.5	136.5	6.5	1.09
—	—	—	—	—	—	—	—	—	78	84	117	1.5	—	—	1.09
N	NR	4.90	3.10	145.24	0.60	0.5	159.7	2.82	81	92	139	2	162	7.3	2.57
—	—	—	—	—	—	—	—	—	81	92	139	2	—	—	2.57
N	NR	1.70	1.30	92.9	0.40	0.5	99.4	1.12	79	79.5	91	0.6	101	2.5	0.149
N	NR	2.50	1.30	102.60	0.40	0.5	110.7	1.12	80	82	100	1	112	3.3	0.364
—	—	—	—	—	—	—	—	—	79	—	111	0.6	—	—	0.463
N	NR	2.87	2.70	111.81	0.60	0.5	121.6	2.46	81.5	85.5	108.5	1	123	5.0	0.649
—	—	—	—	—	—	—	—	—	81.5	85.5	108.5	1	—	—	0.649
N	NR	4.06	3.10	125.22	0.60	0.5	139.7	2.82	83	90	122	1.5	141.5	6.5	1.19
—	—	—	—	—	—	—	—	—	83	90	122	1.5	—	—	1.19
N	NR	4.90	3.10	155.22	0.60	0.5	169.7	2.82	86	98.5	149	2	172	7.3	3.08
—	—	—	—	—	—	—	—	—	86	98.5	149	2	—	—	3.08

- Remarks**
1. Diameter Series 7 (extra thin section bearings) are also available, please contact NSK.
 2. When using bearings with rotating outer rings, contact NSK if they are sealed, shielded, or have snap rings.
 3. Please consult NSK about the snap ring groove dimensions of sealed and shielded bearings when the diameter of dimension series 18 and 19 is 50 mm or more.
 4. The bearings denoted by an asterisk(*) are NSKHS Deep groove ball bearings.

Single-Row Deep Groove Ball Bearings

Bore Diameter 80 - 90 mm

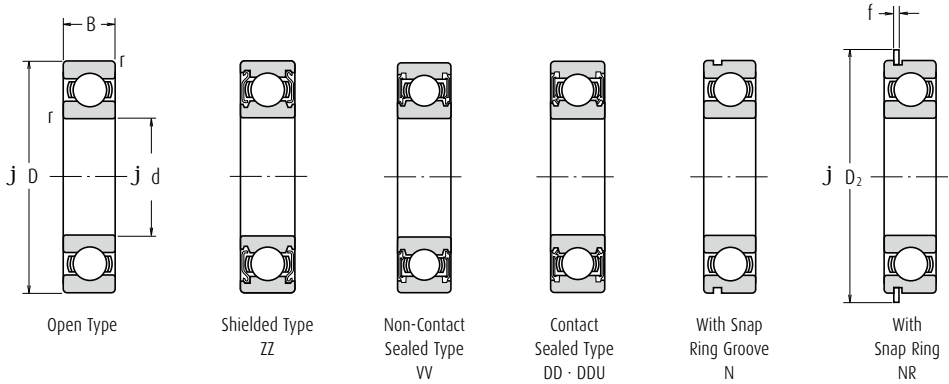

Boundary Dimensions (mm)				Basic Load Ratings (N)		Factor f_o	Limiting Speeds (min ⁻¹)			Bearing Numbers		
d	D	B	r min.	C_r	C_{or}		Grease		Oil	Open	Shielded	Sealed
							Open Z · ZZ V · VV	DU DDU	Open Z			
80	100	10	0.6	12 700	14 500	17.4	6 000	3 400	7 100	6816	ZZ	VV DDU
	110	16	1	25 000	24 000	16.6	5 600	3 200	6 700	6916	ZZ	VV DDU
	125	14	0.6	32 000	29 600	16.4	5 300	—	6 300	16016	—	—
	125	22	1.1	47 500	40 000	15.6	5 300	3 200	6 300	6016	ZZ	VV DDU
	125	22	1.1	50 000	40 000	15.6	6 300	3 200	7 100	6016 ⁽¹⁾	ZZ	VV DDU
	140	26	2	72 500	53 000	14.6	4 500	3 000	5 300	6216	ZZ	VV DDU
	140	26	2.0	76 500	53 000	14.6	5 300	3 000	6 300	6216 ⁽¹⁾	ZZ	VV DDU
	170	39	2.1	123 000	86 500	13.3	4 000	2 800	4 800	6316	ZZ	VV DDU
	170	39	2.1	129 000	86 500	13.3	4 500	2 800	5 600	6316 ⁽¹⁾	ZZ	VV DDU
	85	110	13	1	18 700	20 000	17.1	5 600	3 200	6 700	6817	ZZ
120		18	1.1	32 000	29 600	16.4	5 300	3 000	6 300	6917	ZZ	VV DDU
130		14	0.6	33 000	31 500	16.5	5 000	—	6 000	16017	—	—
130		22	1.1	49 500	43 000	15.8	5 000	3 000	6 000	6017	ZZ	VV DDU
130		22	1.1	52 000	43 000	15.8	6 000	3 000	7 100	6017 ⁽¹⁾	ZZ	VV DDU
150		28	2	84 000	62 000	14.5	4 300	2 800	5 000	6217	ZZ	VV DDU
150		28	2.0	88 000	62 000	14.5	4 800	2 800	6 000	6217 ⁽¹⁾	ZZ	VV DDU
180		41	3	133 000	97 000	13.3	3 800	2 600	4 500	6317	ZZ	VV DDU
180		41	3.0	139 000	97 000	13.3	4 300	2 600	5 000	6317 ⁽¹⁾	ZZ	VV DDU
90		115	13	1	19 000	21 000	17.2	5 300	3 000	6 300	6818	ZZ
	125	18	1.1	33 000	31 500	16.5	5 000	2 800	6 000	6918	ZZ	VV DDU
	140	16	1	41 500	39 500	16.3	4 800	—	5 600	16018	—	—
	140	24	1.5	58 000	50 000	15.6	4 800	2 800	5 600	6018	ZZ	VV DDU
	140	24	1.5	61 000	50 000	15.6	5 600	2 800	6 300	6018 ⁽¹⁾	ZZ	VV DDU
	160	30	2	96 000	71 500	14.5	4 000	2 600	4 800	6218	ZZ	VV DDU
	160	30	2.0	101 000	71 500	14.5	4 500	2 600	5 600	6218 ⁽¹⁾	ZZ	VV DDU
	190	43	3	143 000	107 000	13.3	3 600	2 400	4 300	6318	ZZ	VV DDU
	190	43	3.0	150 000	107 000	13.3	4 000	2 400	4 800	6318 ⁽¹⁾	ZZ	VV DDU

- Notes** (1) For tolerances for the snap ring grooves and snap ring dimensions, refer to Pages **A116** to **A119**.
 (2) When heavy axial loads are applied, increase d_a and decrease D_a from the above values.

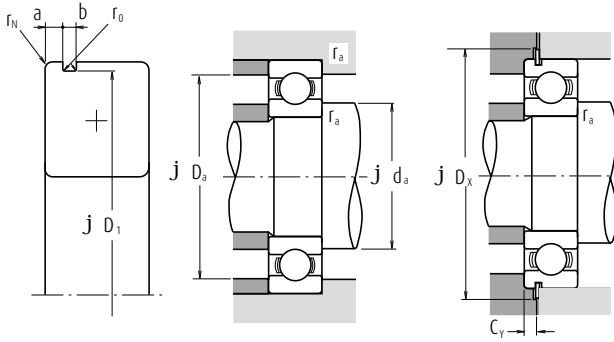

Dynamic Equivalent Load $P=XF_r+YF_a$

$\frac{f_a F_a}{C_{or}}$	e	$\frac{F_a}{F_r} \leq e$		$\frac{F_a}{F_r} > e$	
		X	Y	X	Y
0.172	0.19	1	0	0.56	2.30
0.345	0.22	1	0	0.56	1.99
0.689	0.26	1	0	0.56	1.71
1.03	0.28	1	0	0.56	1.55
1.38	0.30	1	0	0.56	1.45
2.07	0.34	1	0	0.56	1.31
3.45	0.38	1	0	0.56	1.15
5.17	0.42	1	0	0.56	1.04
6.89	0.44	1	0	0.56	1.00

Static Equivalent Load

$$\frac{F_a}{F_r} > 0.8, P_0 = 0.6F_r + 0.5F_a$$

$$\frac{F_a}{F_r} \leq 0.8, P_0 = F_r$$

With Snap Ring Groove	With Snap Ring	Snap Ring Groove Dimensions (1) (mm)					Snap Ring (1) Dimensions (mm)		Abutment and Fillet Dimensions (mm)					Mass (kg) approx.	
		a max.	b min.	D ₁ max.	r ₀ max.	r _N min.	D ₂ max.	f max.	d _a (2) min.	d _a (2) max.	D _a (2) max.	r _a max.	D _x min.		C _y max.
N	NR	1.70	1.3	97.9	0.4	0.5	104.4	1.12	84	84.5	96	0.6	106	2.5	0.151
N	NR	2.50	1.3	107.60	0.4	0.5	115.7	1.12	85	87.5	105	1	117	3.3	0.391
—	—	—	—	—	—	—	—	—	84	—	121	0.6	—	—	0.621
N	NR	2.87	3.1	120.22	0.6	0.5	134.7	2.82	86.5	91	118.5	1	136.5	5.3	0.872
—	—	—	—	—	—	—	—	—	86.5	91	118.5	1	—	—	0.872
N	NR	4.90	3.1	135.23	0.6	0.5	149.7	2.82	89	95.5	131	2	152	7.3	1.42
—	—	—	—	—	—	—	—	—	89	95.5	131	2	—	—	1.42
N	NR	5.69	3.5	163.65	0.6	0.5	182.9	3.10	91	104.5	159	2	185	8.4	3.67
—	—	—	—	—	—	—	—	—	91	104.5	159	2	—	—	3.67
N	NR	2.10	1.3	107.60	0.4	0.5	115.7	1.12	90	90.5	105	1	117	2.9	0.263
N	NR	3.30	1.3	117.60	0.4	0.5	125.7	1.12	91.5	94.5	113.5	1	127	4.1	0.55
—	—	—	—	—	—	—	—	—	89	—	126	0.6	—	—	0.652
N	NR	2.87	3.1	125.22	0.6	0.5	139.7	2.82	91.5	96	123.5	1	141.5	5.3	0.918
—	—	—	—	—	—	—	—	—	91.5	96	123.5	1	—	—	0.918
N	NR	4.90	3.1	145.24	0.6	0.5	159.7	2.82	94	102	141	2	162	7.3	1.76
—	—	—	—	—	—	—	—	—	94	102	141	2	—	—	1.76
N	NR	5.69	3.5	173.66	0.6	0.5	192.9	3.10	98	110.5	167	2.5	195	8.4	4.28
—	—	—	—	—	—	—	—	—	98	110.5	167	2.5	—	—	4.28
N	NR	2.10	1.3	112.60	0.4	0.5	120.7	1.12	95	95.5	110	1	122	2.9	0.276
N	NR	3.30	1.3	122.60	0.4	0.5	130.7	1.12	96.5	98.5	118.5	1	132	4.1	0.585
—	—	—	—	—	—	—	—	—	95	—	135	1	—	—	0.873
N	NR	3.71	3.1	135.23	0.6	0.5	149.7	2.82	98	103	132	1.5	152	6.1	1.19
—	—	—	—	—	—	—	—	—	98	103	132	1.5	—	—	1.19
N	NR	4.90	3.1	155.22	0.6	0.5	169.7	2.82	99	107.5	151	2	172	7.3	2.18
—	—	—	—	—	—	—	—	—	99	107.5	151	2	—	—	2.18
N	NR	5.69	3.5	183.64	0.6	0.5	202.9	3.10	103	117	177	2.5	205	8.4	4.98
—	—	—	—	—	—	—	—	—	103	117	177	2.5	—	—	4.98

- Remarks**
1. Diameter Series 7 (extra thin section bearings) are also available, please contact NSK.
 2. When using bearings with rotating outer rings, contact NSK if they are sealed, shielded, or have snap rings.
 3. Please consult NSK about the snap ring groove dimensions of sealed and shielded bearings when the diameter of dimension series 18 and 19 is 50 mm or more.
 4. The bearings denoted by an asterisk(*) are NSKHPs Deep groove ball bearings.

Single-Row Deep Groove Ball Bearings

Bore Diameter 95 – 105 mm

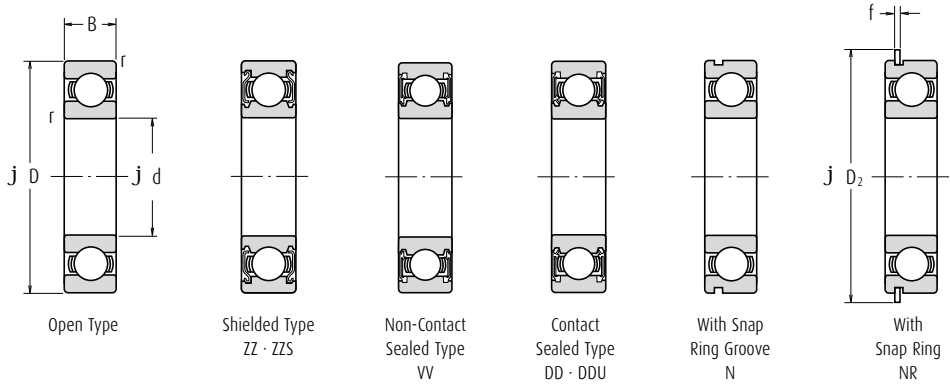

Boundary Dimensions (mm)				Basic Load Ratings (N)		Factor f_0	Limiting Speeds (min ⁻¹)			Bearing Numbers				
d	D	B	r min.	C_r	C_{or}		Grease		Oil	Open	Shielded	Sealed		
							Open Z · ZZ V · VV	DU DDU	Open Z					
95	120	13	1	19 300	22 000	17.2	5 000	2 800	6 000	6819	ZZ	VV	DD	
	130	18	1.1	33 500	33 500	16.6	4 800	2 800	5 600	6919	ZZ	VV	DDU	
	145	16	1	43 000	42 000	16.4	4 500	—	5 300	16019	—	—	—	
	145	24	1.5	60 500	54 000	15.8	4 500	2 600	5 300	6019	ZZ	VV	DDU	
	145	24	1.5	63 500	54 000	15.8	5 300	2 600	6 000	6019 ²	ZZ	VV	DDU	
	170	32	2.1	109 000	82 000	14.4	3 800	2 600	4 500	6219	ZZ	VV	DDU	
	170	32	2.1	114 000	82 000	14.4	4 300	2 600	5 000	6219 ²	ZZ	VV	DDU	
	200	45	3	153 000	119 000	13.3	3 000	2 400	3 600	6319	ZZ	VV	DDU	
	200	45	3.0	160 000	119 000	13.3	3 400	2 400	4 300	6319 ²	ZZ	VV	DDU	
	100	125	13	1	19 600	23 000	17.3	4 800	2 800	5 600	6820	ZZ	VV	DD
140		20	1.1	43 000	42 000	16.4	4 500	2 600	5 300	6920	ZZ	VV	DDU	
150		16	1	42 500	42 000	16.5	4 300	—	5 300	16020	—	—	—	
150		24	1.5	60 000	54 000	15.9	4 300	2 600	5 300	6020	ZZ	VV	DDU	
150		24	1.5	63 000	54 000	15.9	5 000	2 600	6 000	6020 ²	ZZ	VV	DDU	
180		34	2.1	122 000	93 000	14.4	3 600	2 400	4 300	6220	ZZ	VV	DDU	
180		34	2.1	128 000	93 000	14.4	4 000	2 400	4 800	6220 ²	ZZ	VV	DDU	
215		47	3	173 000	141 000	13.2	2 800	2 200	3 400	6320	ZZ	VV	DDU	
105		130	13	1	19 800	23 900	17.4	4 800	2 600	5 600	6821	ZZ	VV	DDU
		145	20	1.1	42 500	42 000	16.5	4 300	—	5 300	6921	ZZ	VV	—
	160	18	1	52 000	50 500	16.3	4 000	—	4 800	16021	—	—	—	
	160	26	2	72 500	66 000	15.8	4 000	2 400	4 800	6021	ZZ	VV	DDU	
	160	26	2.0	76 000	66 000	15.8	4 500	2 400	5 600	6021 ²	ZZ	VV	DDU	
	190	36	2.1	133 000	105 000	14.4	3 400	2 200	4 000	6221	ZZ	VV	DDU	
	190	36	2.1	140 000	105 000	14.4	3 800	2 200	4 500	6221 ²	ZZ	VV	DDU	
	225	49	3	184 000	154 000	13.2	2 600	2 000	3 200	6321	ZZ	—	DDU	

- Notes** (1) For tolerances for the snap ring grooves and snap ring dimensions, refer to Pages **A116** to **A119**.
 (2) When heavy axial loads are applied, increase d_a and decrease D_a from the above values.

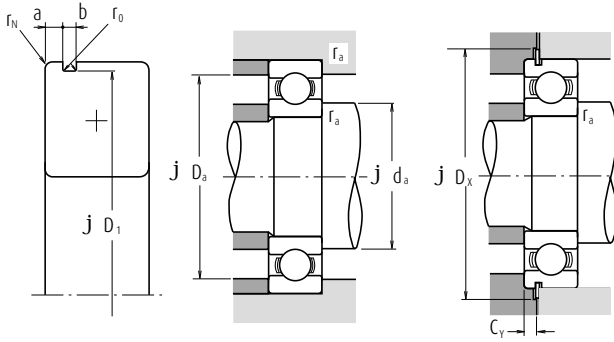

Dynamic Equivalent Load $P=XF_r+YF_a$

$\frac{f_a F_a}{C_{or}}$	e	$\frac{F_a}{F_r} \leq e$		$\frac{F_a}{F_r} > e$	
		X	Y	X	Y
0.172	0.19	1	0	0.56	2.30
0.345	0.22	1	0	0.56	1.99
0.689	0.26	1	0	0.56	1.71
1.03	0.28	1	0	0.56	1.55
1.38	0.30	1	0	0.56	1.45
2.07	0.34	1	0	0.56	1.31
3.45	0.38	1	0	0.56	1.15
5.17	0.42	1	0	0.56	1.04
6.89	0.44	1	0	0.56	1.00

Static Equivalent Load

$$\frac{F_a}{F_r} > 0.8, P_0 = 0.6F_r + 0.5F_a$$

$$\frac{F_a}{F_r} \leq 0.8, P_0 = F_r$$

With Snap Ring Groove	With Snap Ring	Snap Ring Groove Dimensions (1) (mm)					Snap Ring (1) Dimensions (mm)		Abutment and Fillet Dimensions (mm)						Mass (kg) approx.
		a max.	b min.	D ₁ max.	r ₀ max.	r _N min.	D ₂ max.	f max.	d _a (2) min.	d _a (2) max.	r _a max.	D _x min.	C _y max.		
N	NR	2.10	1.3	117.60	0.4	0.5	125.7	1.12	100	101.5	115	1	127	2.9	0.297
N	NR	3.30	1.3	127.60	0.4	0.5	135.7	1.12	101.5	103.5	123.5	1	137	4.1	0.601
—	—	—	—	—	—	—	—	—	100	—	140	1	—	—	0.904
N	NR	3.71	3.1	140.23	0.6	0.5	154.7	2.82	103	108.5	137	1.5	157	6.1	1.23
—	—	—	—	—	—	—	—	—	103	108.5	137	1.5	—	—	1.23
N	NR	5.69	3.5	163.65	0.6	0.5	182.9	3.10	106	114	159	2	185	8.4	2.64
—	—	—	—	—	—	—	—	—	106	114	159	2	—	—	2.64
N	NR	5.69	3.5	193.65	0.6	0.5	212.9	3.10	108	123.5	187	2.5	215	8.4	5.76
—	—	—	—	—	—	—	—	—	108	123.5	187	2.5	—	—	5.76
N	NR	2.10	1.3	122.60	0.4	0.5	130.7	1.12	105	105.5	120	1	132	2.9	0.31
N	NR	3.30	1.9	137.60	0.6	0.5	145.7	1.70	106.5	111	133.5	1	147	4.7	0.828
—	—	—	—	—	—	—	—	—	105	—	145	1	—	—	0.945
N	NR	3.71	3.1	145.24	0.6	0.5	159.7	2.82	108	112.5	142	1.5	162	6.1	1.29
—	—	—	—	—	—	—	—	—	108	112.5	142	1.5	—	—	1.29
N	NR	5.69	3.5	173.66	0.6	0.5	192.9	3.10	111	121.5	169	2	195	8.4	3.17
—	—	—	—	—	—	—	—	—	111	121.5	169	2	—	—	3.17
—	—	—	—	—	—	—	—	—	113	133	202	2.5	—	—	7.04
N	NR	2.10	1.3	127.60	0.4	0.5	135.7	1.12	110	110.5	125	1	137	2.9	0.324
N	NR	3.30	1.9	142.60	0.6	0.5	150.7	1.70	111.5	116	138.5	1	152	4.7	0.856
—	—	—	—	—	—	—	—	—	110	—	155	1	—	—	1.24
N	NR	3.71	3.1	155.22	0.6	0.5	169.7	2.82	114	120	151	2	172	6.1	1.58
—	—	—	—	—	—	—	—	—	114	120	151	2	—	—	1.58
N	NR	5.69	3.5	183.64	0.6	0.5	202.9	3.10	116	127.5	179	2	205	8.4	3.79
—	—	—	—	—	—	—	—	—	116	127.5	179	2	—	—	3.79
—	—	—	—	—	—	—	—	—	118	138	212	2.5	—	—	8.09

- Remarks**
1. Diameter Series 7 (extra thin section bearings) are also available, please contact NSK.
 2. When using bearings with rotating outer rings, contact NSK if they are sealed, shielded, or have snap rings.
 3. Please consult NSK about the snap ring groove dimensions of sealed and shielded bearings when the diameter of dimension series 18 and 19 is 50 mm or more.
 4. The bearings denoted by an asterisk(*) are NSKHPS Deep groove ball bearings.

Single-Row Deep Groove Ball Bearings

Bore Diameter 110 – 150 mm

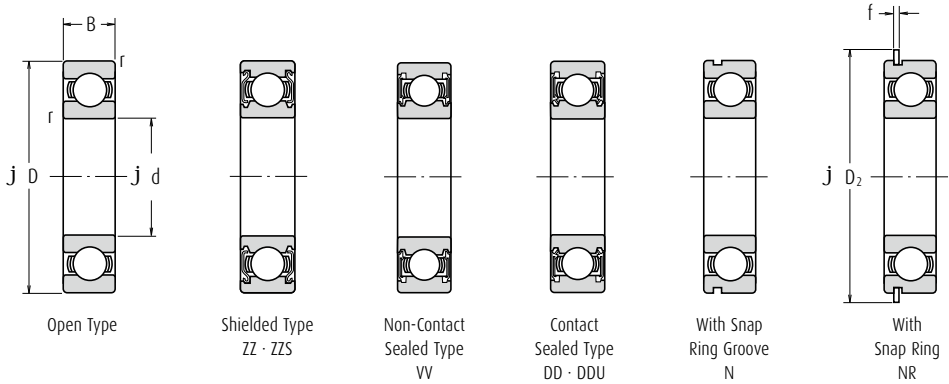

Boundary Dimensions (mm)				Basic Load Ratings (N)		Factor f_0	Limiting Speeds (min ⁻¹)			Bearing Numbers			
d	D	B	r min.	C_r	C_{or}		Grease		Oil	Open	Shielded	Sealed	
							Open Z · ZZ V · VV	DU DDU	Open Z				
110	140	16	1	28 100	32 500	17.1	4 300	2 400	5 300	6822	ZZ	VV	DDU
	150	20	1.1	43 500	44 500	16.6	4 300	2 400	5 000	6922	ZZ	VV	DDU
	170	19	1	57 500	56 500	16.3	3 800	—	4 500	16022	—	—	—
	170	28	2	85 000	73 000	15.5	3 800	2 200	4 500	6022	ZZ	VV	DDU
	170	28	2.0	89 000	73 000	15.5	4 500	2 200	5 300	6022 ²	ZZ	VV	DDU
	200	38	2.1	144 000	117 000	14.3	2 800	2 200	3 400	6222	ZZ	VV	DDU
	240	50	3	205 000	179 000	13.2	2 400	—	3 000	6322	ZZ	—	—
120	150	16	1	28 900	35 500	17.3	4 000	2 200	4 800	6824	ZZ	VV	DD
	165	22	1.1	53 000	54 000	16.5	3 800	—	4 500	6924	ZZ	—	—
	180	19	1	56 500	57 500	16.5	3 600	—	4 300	16024	—	—	—
	180	28	2	88 000	80 000	15.7	3 600	2 200	4 300	6024	ZZ	VV	DDU
	180	28	2.0	92 500	80 000	15.7	4 000	2 200	4 800	6024 ²	ZZ	VV	DDU
	215	40	2.1	155 000	131 000	14.4	2 600	2 000	3 200	6224	ZZ	VV	DDU
	260	55	3	207 000	185 000	13.5	2 200	1 800	2 800	6324	ZZS	—	DDU
130	165	18	1.1	37 000	44 000	17.1	3 600	2 000	4 300	6826	ZZS	VV	DD
	180	24	1.5	65 000	67 500	16.5	3 400	—	4 000	6926	ZZ	—	—
	200	22	1.1	75 500	77 500	16.4	3 000	—	3 600	16026	—	—	—
	200	33	2	106 000	101 000	15.8	3 000	1 900	3 600	6026	ZZ	—	DDU
	230	40	3	167 000	146 000	14.5	2 400	—	3 000	6226	ZZ	—	—
	280	58	4	229 000	214 000	13.6	2 200	—	2 600	6326	ZZS	—	—
	175	18	1.1	38 500	48 000	17.3	3 400	1 900	4 000	6828	ZZ	VV	DDU
140	190	24	1.5	66 500	72 000	16.6	3 200	—	3 800	6928	ZZS	VV	—
	210	22	1.1	77 500	82 500	16.5	2 800	—	3 400	16028	—	—	—
	210	33	2	110 000	109 000	16.0	2 800	1 800	3 400	6028	ZZ	—	DDU
	250	42	3	166 000	150 000	14.9	2 200	1 700	2 800	6228	ZZS	—	DDU
	300	62	4	253 000	246 000	13.6	2 000	—	2 400	6328	ZZS	—	—
	190	20	1.1	47 500	58 500	17.1	3 200	1 800	3 800	6830	ZZ	VV	DDU
	210	28	2	85 000	90 500	16.5	2 600	1 700	3 200	6930	ZZS	—	DDU
150	225	24	1.1	84 000	91 000	16.6	2 600	—	3 000	16030	—	—	—
	225	35	2.1	126 000	126 000	15.9	2 600	1 700	3 000	6030	ZZ	VV	DDU
	270	45	3	176 000	168 000	15.1	2 000	—	2 600	6230	ZZS	—	—
	320	65	4	274 000	284 000	13.9	1 800	—	2 200	6330	ZZS	—	—

- Notes** (1) For tolerances for the snap ring grooves and snap ring dimensions, refer to Pages **A116** to **A119**.
 (2) When heavy axial loads are applied, increase d_0 and decrease D_0 from the above values.

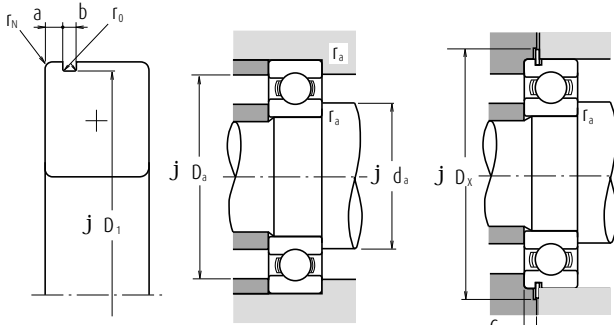

Dynamic Equivalent Load $P=XF_r+YF_a$

$\frac{f_a F_a}{C_{or}}$	e	$\frac{F_a}{F_r} \leq e$		$\frac{F_a}{F_r} > e$	
		X	Y	X	Y
0.172	0.19	1	0	0.56	2.30
0.345	0.22	1	0	0.56	1.99
0.689	0.26	1	0	0.56	1.71
1.03	0.28	1	0	0.56	1.55
1.38	0.30	1	0	0.56	1.45
2.07	0.34	1	0	0.56	1.31
3.45	0.38	1	0	0.56	1.15
5.17	0.42	1	0	0.56	1.04
6.89	0.44	1	0	0.56	1.00

Static Equivalent Load

$$\frac{F_a}{F_r} > 0.8, P_0 = 0.6F_r + 0.5F_a$$

$$\frac{F_a}{F_r} \leq 0.8, P_0 = F_r$$

With Snap Ring Groove	With Snap Ring	Snap Ring Groove Dimensions (*) (mm)					Snap Ring (*) Dimensions (mm)		Abutment and Fillet Dimensions (mm)					Mass (kg) approx.	
		a max.	b min.	D ₁ max.	r ₀ max.	r _N min.	D ₂ max.	f max.	d _a (?) min.	d _a (?) max.	D _x (?) max.	r _a max.	D _x min.		C _y max.
N	NR	2.50	1.9	137.60	0.6	0.5	145.7	1.7	115	117	135	1	147	3.9	0.497
N	NR	3.30	1.9	147.60	0.6	0.5	155.7	1.7	116.5	121	143.5	1	157	4.7	0.893
—	—	—	—	—	—	—	—	—	115	—	165	1	—	—	1.51
N	NR	3.71	3.5	163.65	0.6	0.5	182.9	3.1	119	124.5	161	2	185	6.4	1.94
—	—	—	—	—	—	—	—	—	119	124.5	161	2	—	—	1.94
N	NR	5.69	3.5	193.65	0.6	0.5	212.9	3.1	121	134	189	2	215	8.4	4.45
—	—	—	—	—	—	—	—	—	123	147	227	2.5	—	—	9.51
N	NR	2.50	1.9	147.60	0.6	0.5	155.7	1.7	125	127	145	1	157	3.9	0.537
N	NR	3.70	1.9	161.80	0.6	0.5	171.5	1.7	126.5	132	158.5	1	173	5.1	1.21
—	—	—	—	—	—	—	—	—	125	—	175	1	—	—	1.6
N	NR	3.71	3.5	173.66	0.6	0.5	192.9	3.1	129	134.5	171	2	195	6.4	2.08
—	—	—	—	—	—	—	—	—	129	134.5	171	2	—	—	2.08
—	—	—	—	—	—	—	—	—	131	146	204	2	—	—	5.29
—	—	—	—	—	—	—	—	—	133	161	247	2.5	—	—	12.5
N	NR	3.30	1.9	161.80	0.6	0.5	171.5	1.7	136.5	138	158.5	1	173	4.7	0.758
N	NR	3.70	1.9	176.80	0.6	0.5	186.5	1.7	138	144	172	1.5	188	5.1	1.57
—	—	—	—	—	—	—	—	—	136.5	—	193.5	1	—	—	2.4
N	NR	5.69	3.5	193.65	0.6	0.5	212.9	3.1	139	148.5	191	2	215	8.4	3.26
—	—	—	—	—	—	—	—	—	143	157	217	2.5	—	—	5.96
—	—	—	—	—	—	—	—	—	146	175	264	3	—	—	15.2
N	NR	3.30	1.9	171.80	0.6	0.5	181.5	1.7	146.5	148.5	168.5	1	183	4.7	0.832
N	NR	3.70	1.9	186.80	0.6	0.5	196.5	1.7	148	153.5	182	1.5	198	5.1	1.67
—	—	—	—	—	—	—	—	—	146.5	—	203.5	1	—	—	2.84
—	—	—	—	—	—	—	—	—	149	158.5	201	2	—	—	3.48
—	—	—	—	—	—	—	—	—	153	171.5	237	2.5	—	—	7.68
—	—	—	—	—	—	—	—	—	156	187	284	3	—	—	18.5
N	NR	3.30	1.9	186.80	0.6	0.5	196.5	1.7	156.5	160	183.5	1	198	4.7	1.15
—	—	—	—	—	—	—	—	—	159	166	201	2	—	—	3.01
—	—	—	—	—	—	—	—	—	156.5	—	218.5	1	—	—	3.62
—	—	—	—	—	—	—	—	—	161	170	214	2	—	—	4.24
—	—	—	—	—	—	—	—	—	163	186	257	2.5	—	—	10
—	—	—	—	—	—	—	—	—	166	203	304	3	—	—	22.7

Remarks

- When using bearings with rotating outer rings, contact NSK if they are sealed, shielded, or have snap rings.
- Please consult NSK about the snap ring groove dimensions of sealed and shielded bearings when the diameter of dimension series 18 and 19 is 50 mm or more.
- The bearings denoted by an asterisk(*) are NSKHPs Deep groove ball bearings.

Single-Row Deep Groove Ball Bearings

Bore Diameter 160 mm

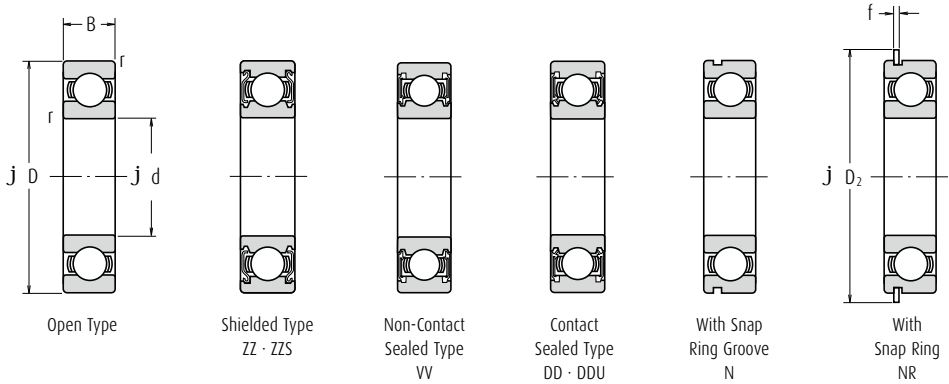

Boundary Dimensions (mm)				Basic Load Ratings (N)		Factor f_o	Limiting Speeds (min ⁻¹)			Bearing Numbers			
d	D	B	r min.	C_r	C_{or}		Grease		Oil	Open	Shielded	Sealed	
							Open Z · ZZ V · VV	DU DDU	Open Z				
160	200	20	1.1	48 500	61 000	17.2	2 600	1 700	3 200	6832	ZZS	VV	DDU
	220	28	2	87 000	96 000	16.6	2 600	1 600	3 000	6932	ZZS	—	DDU
	240	25	1.5	99 000	108 000	16.5	2 400	—	2 800	16032	—	—	—
	240	38	2.1	137 000	135 000	15.9	2 400	1 600	2 800	6032	ZZ	—	DDU
	290	48	3	185 000	186 000	15.4	1 900	—	2 400	6232	ZZS	—	—
	340	68	4	278 000	287 000	13.9	1 700	—	2 400	6332	ZZS	—	—

- Notes**
- (1) For tolerances for the snap ring grooves and snap ring dimensions, refer to Pages **A116** to **A119**.
 - (2) When heavy axial loads are applied, increase d_a and decrease D_a from the above values.

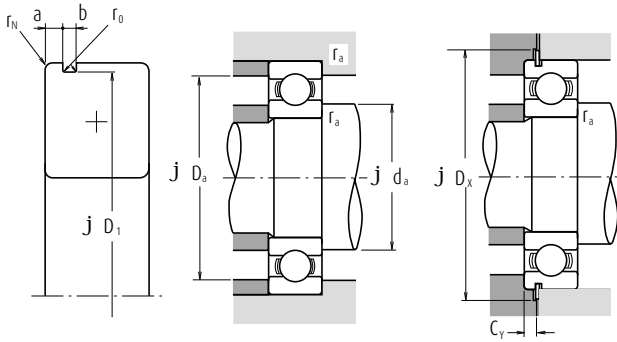

Dynamic Equivalent Load $P=XF_r+YF_a$

$\frac{f_a F_a}{C_{or}}$	e	$\frac{F_a}{F_r} \leq e$		$\frac{F_a}{F_r} > e$	
		X	Y	X	Y
0.172	0.19	1	0	0.56	2.30
0.345	0.22	1	0	0.56	1.99
0.689	0.26	1	0	0.56	1.71
1.03	0.28	1	0	0.56	1.55
1.38	0.30	1	0	0.56	1.45
2.07	0.34	1	0	0.56	1.31
3.45	0.38	1	0	0.56	1.15
5.17	0.42	1	0	0.56	1.04
6.89	0.44	1	0	0.56	1.00

Static Equivalent Load

$$\frac{F_a}{F_r} > 0.8, P_0 = 0.6F_r + 0.5F_a$$

$$\frac{F_a}{F_r} \leq 0.8, P_0 = F_r$$

With Snap Ring Groove	With Snap Ring	Snap Ring Groove Dimensions (1) (mm)					Snap Ring (1) Dimensions (mm)		Abutment and Fillet Dimensions (mm)						Mass (kg) approx.
		a max.	b min.	D ₁ max.	r ₀ max.	r _N min.	D ₂ max.	f max.	d _a (2) min.	d _a (2) max.	D _a (2) max.	r _a max.	D _x min.	C _y max.	
N	NR	3.30	1.9	196.80	0.6	0.5	206.5	1.7	166.5	170.5	193.5	1	208	4.7	1.23
—	—	—	—	—	—	—	—	—	169	176	211	2	—	—	2.71
—	—	—	—	—	—	—	—	—	168	—	232	1.5	—	—	4.2
—	—	—	—	—	—	—	—	—	171	181.5	229	2	—	—	5.15
—	—	—	—	—	—	—	—	—	173	202	277	2.5	—	—	12.8
—	—	—	—	—	—	—	—	—	176	215.5	324	3	—	—	26.2

- Remarks**
1. When using bearings with rotating outer rings, contact NSK if they are sealed, shielded, or have snap rings.
 2. Please consult NSK about the snap ring groove dimensions of sealed and shielded bearings when the diameter of dimension series 18 and 19 is 50 mm or more.

Single-Row Deep Groove Ball Bearings

Bore Diameter 170 - 240 mm

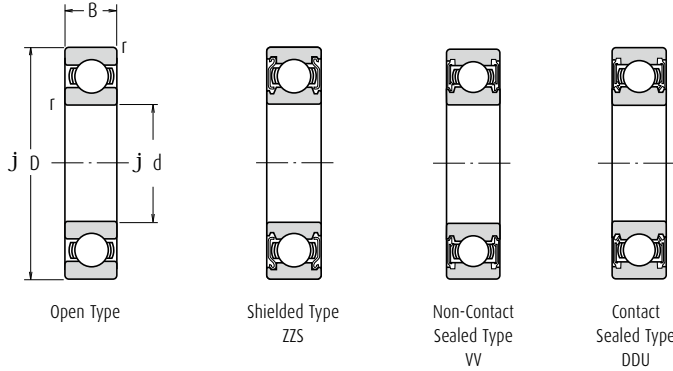

Boundary Dimensions (mm)				Basic Load Ratings (N)		Factor f_0	Limiting Speeds (min ⁻¹)			Bearing Numbers			
d	D	B	r min.	C_r	C_{or}		Grease		Oil	Open	Shielded	Sealed	
							Open Z · ZZ V · VV	DU DDU	Open Z				
170	215	22	1.1	60 000	75 000	17.1	2 600	1 600	3 000	6834	ZZS	VV	DDU
	230	28	2	86 000	97 000	16.7	2 400	—	2 800	6934	ZZS	—	—
	260	28	1.5	114 000	126 000	16.5	2 200	—	2 600	16034	—	—	—
	260	42	2.1	161 000	161 000	15.8	2 200	—	2 600	6034	ZZS	VV	—
	310	52	4	212 000	224 000	15.3	1 800	—	2 200	6234	ZZS	—	—
360	72	4	325 000	355 000	13.6	1 600	—	2 000	6334	—	—	—	
180	225	22	1.1	60 500	78 500	17.2	2 400	—	2 800	6836	—	VV	—
	250	33	2	119 000	128 000	16.4	2 200	—	2 600	6936	ZZS	—	—
	280	31	2	145 000	157 000	16.3	2 000	—	2 400	16036	—	—	—
	280	46	2.1	180 000	185 000	15.6	2 000	—	2 400	6036	ZZS	VV	—
	320	52	4	227 000	241 000	15.1	1 700	—	2 000	6236	ZZS	—	—
380	75	4	355 000	405 000	13.9	1 500	—	1 800	6336	—	—	—	
190	240	24	1.5	73 000	93 500	17.1	2 200	—	2 600	6838	—	VV	—
	260	33	2	113 000	127 000	16.6	2 200	—	2 600	6938	—	—	—
	290	31	2	149 000	168 000	16.4	2 000	—	2 400	16038	—	—	—
	290	46	2.1	188 000	201 000	15.8	2 000	—	2 400	6038	ZZS	—	—
	340	55	4	255 000	282 000	15.0	1 600	—	2 000	6238	ZZS	—	—
400	78	5	355 000	415 000	14.1	1 400	—	1 700	6338	—	—	—	
200	250	24	1.5	74 000	98 000	17.2	2 200	—	2 600	6840	—	—	—
	280	38	2.1	143 000	158 000	16.4	2 000	—	2 400	6940	ZZS	—	—
	310	34	2	161 000	180 000	16.4	1 900	—	2 200	16040	—	—	—
	310	51	2.1	207 000	226 000	15.6	1 900	—	2 200	6040	ZZS	—	—
	360	58	4	269 000	310 000	15.2	1 500	—	1 800	6240	ZZS	—	—
420	80	5	380 000	445 000	13.8	1 300	—	1 600	6340	—	—	—	
220	270	24	1.5	76 500	107 000	17.4	1 900	—	2 400	6844	ZZS	—	—
	300	38	2.1	146 000	169 000	16.6	1 800	—	2 200	6944	ZZS	—	—
	340	37	2.1	180 000	217 000	16.5	1 600	—	2 000	16044	—	—	—
	340	56	3	235 000	271 000	15.6	1 700	—	2 000	6044	ZZS	—	—
	400	65	4	310 000	375 000	15.1	1 300	—	1 600	6244	—	—	—
460	88	5	410 000	520 000	14.3	1 200	—	1 500	6344	—	—	—	
240	300	28	2	98 500	137 000	17.3	1 700	—	2 000	6848	—	—	—
	320	38	2.1	154 000	190 000	16.8	1 700	—	2 000	6948	ZZS	—	—
	360	37	2.1	196 000	243 000	16.5	1 500	—	1 900	16048	—	—	—
	360	56	3	244 000	296 000	15.9	1 500	—	1 900	6048	—	—	—
	440	72	4	340 000	430 000	15.2	1 200	—	1 500	6248	—	—	—
500	95	5	470 000	625 000	14.2	1 100	—	1 300	6348	—	—	—	

Note (1) When heavy axial loads are applied, increase d_0 and decrease D_0 from the above values.

Remark When using bearings with rotating outer rings, contact NSK if they are sealed or shielded.

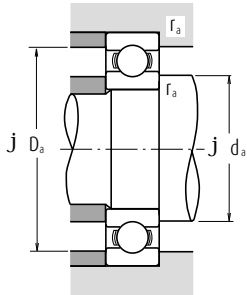

Dynamic Equivalent Load $P=XF_r+YF_a$

$\frac{f_d F_a}{C_{or}}$	e	$\frac{F_a}{F_r} \leq e$		$\frac{F_a}{F_r} > e$	
		X	Y	X	Y
0.172	0.19	1	0	0.56	2.30
0.345	0.22	1	0	0.56	1.99
0.689	0.26	1	0	0.56	1.71
1.03	0.28	1	0	0.56	1.55
1.38	0.30	1	0	0.56	1.45
2.07	0.34	1	0	0.56	1.31
3.45	0.38	1	0	0.56	1.15
5.17	0.42	1	0	0.56	1.04
6.89	0.44	1	0	0.56	1.00

Static Equivalent Load

$$\frac{F_a}{F_r} > 0.8, P_0 = 0.6F_r + 0.5F_a$$

$$\frac{F_a}{F_r} \leq 0.8, P_0 = F_r$$

Abutment and Fillet Dimensions (mm)				Mass (kg)
min.	$d_a(t)$ max.	$D_a(t)$ max.	r_a max.	approx.
176.5	182.0	208.5	1	1.86
179	186.0	221	2	3.34
178	—	252	1.5	5.71
181	194.5	249	2	6.89
186	215.0	294	3	15.8
186	—	344	3	36.6
186.5	192.0	218.5	1	1.98
189	198.5	241	2	4.16
189	—	271	2	7.5
191	208.0	269	2	8.88
196	223.0	304	3	15.9
196	—	364	3	43.1
198	202.5	232	1.5	2.53
199	—	251	2	5.18
199	—	281	2	7.78
201	218.0	279	2	9.39
206	236.0	324	3	22.3
210	—	380	4	49.7
208	—	242	1.5	2.67
211	222.0	269	2	7.28
209	—	301	2	10
211	231.5	299	2	12
216	252.0	344	3	26.7
220	—	400	4	55.3
228	233.5	262	1.5	2.9
231	242.0	289	2	7.88
231	—	329	2	13.1
233	254.5	327	2.5	18.6
236	—	384	3	37.4
240	—	440	4	73.9
249	—	291	2	4.48
251	262.0	309	2	8.49
251	—	349	2	13.9
253	—	347	2.5	19.9
256	—	424	3	50.5
260	—	480	4	94.4

Single-Row Deep Groove Ball Bearings

Bore Diameter 260 – 360 mm

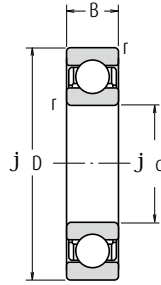

Open Type

Boundary Dimensions (mm)				Basic Load Ratings (N)		Factor	Limiting Speeds (min ⁻¹)		Bearing Numbers
d	D	B	r min.	C _r	C _{0r}	f ₀	Grease	Oil	Open
260	320	28	2	101 000	148 000	17.4	1 600	1 900	6852
	360	46	2.1	204 000	255 000	16.5	1 500	1 800	6952
	400	44	3	237 000	310 000	16.4	1 400	1 700	16052
	400	65	4	291 000	375 000	15.8	1 400	1 700	6052
	480	80	5	400 000	540 000	15.1	1 100	1 300	6252
280	540	102	6	505 000	710 000	14.6	1 000	1 200	6352
	350	33	2	133 000	191 000	17.3	1 500	1 700	6856
	380	46	2.1	209 000	272 000	16.6	1 400	1 700	6956
	420	44	3	243 000	330 000	16.5	1 300	1 600	16056
	420	65	4	300 000	410 000	16.0	1 300	1 600	6056
300	500	80	5	400 000	550 000	15.2	1 000	1 300	6256
	580	108	6	570 000	840 000	14.5	900	1 100	6356
	380	38	2.1	166 000	233 000	17.1	1 300	1 600	6860
	420	56	3	269 000	370 000	16.4	1 300	1 500	6960
	460	50	4	285 000	405 000	16.4	1 200	1 400	16060
320	460	74	4	355 000	500 000	15.8	1 200	1 400	6060
	540	85	5	465 000	670 000	15.1	950	1 200	6260
	400	38	2.1	168 000	244 000	17.2	1 300	1 500	6864
	440	56	3	266 000	375 000	16.5	1 200	1 400	6964
	480	50	4	293 000	430 000	16.5	1 100	1 300	16064
340	480	74	4	390 000	570 000	15.7	1 100	1 300	6064
	580	92	5	530 000	805 000	15.0	850	1 100	6264
	420	38	2.1	175 000	265 000	17.3	1 200	1 400	6868
	460	56	3	273 000	400 000	16.6	1 100	1 300	6968
	520	82	5	440 000	660 000	15.6	1 000	1 200	6068
360	620	92	6	530 000	820 000	15.3	800	1 000	6268
	440	38	2.1	192 000	290 000	17.3	1 100	1 300	6872
	480	56	3	280 000	425 000	16.7	1 100	1 300	6972
	540	82	5	460 000	720 000	15.7	950	1 200	6072
	650	95	6	555 000	905 000	15.4	750	950	6272

Note (1) When heavy axial loads are applied, increase d_0 and decrease D_0 from the above values.

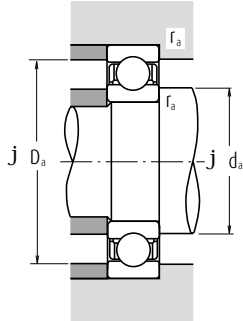

Dynamic Equivalent Load $P=XF_r+YF_a$

$\frac{f_0 F_a}{C_{or}}$	e	$\frac{F_a \leq e}{F_r}$		$\frac{F_a > e}{F_r}$	
		X	Y	X	Y
0.172	0.19	1	0	0.56	2.30
0.345	0.22	1	0	0.56	1.99
0.689	0.26	1	0	0.56	1.71
1.03	0.28	1	0	0.56	1.55
1.38	0.30	1	0	0.56	1.45
2.07	0.34	1	0	0.56	1.31
3.45	0.38	1	0	0.56	1.15
5.17	0.42	1	0	0.56	1.04
6.89	0.44	1	0	0.56	1.00

Static Equivalent Load

$$\frac{F_a}{F_r} > 0.8, P_0 = 0.6F_r + 0.5F_a$$

$$\frac{F_a}{F_r} \leq 0.8, P_0 = F_r$$

Abutment and Fillet Dimensions (mm)			Mass (kg)
d_a (l) min.	D_a (l) max.	r_a max.	approx.
269	311	2	4.84
271	349	2	14
273	387	2.5	21.1
276	384	3	29.4
280	460	4	67
286	514	5	118
289	341	2	7.2
291	369	2	15.1
293	407	2.5	22.7
296	404	3	31.2
300	480	4	70.4
306	554	5	144
311	369	2	10.3
313	407	2.5	23.9
316	444	3	31.5
316	444	3	44.2
320	520	4	87.8
331	389	2	10.8
333	427	2.5	25.3
336	464	3	33.2
336	464	3	46.5
340	560	4	111
351	409	2	11.5
353	447	2.5	26.6
360	500	4	62.3
366	594	5	129
371	429	2	11.8
373	467	2.5	27.9
380	520	4	65.3
386	624	5	145

Single-Row Deep Groove Ball Bearings

Bore Diameter 380 – 600 mm

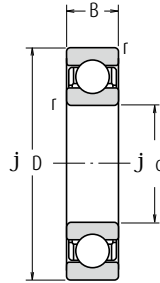

Open Type

Boundary Dimensions (mm)				Basic Load Ratings (N)		Factor	Limiting Speeds (min ⁻¹)		Bearing Numbers
d	D	B	r min.	C _r	C _{0r}	f ₀	Grease	Oil	Open
380	480	46	2.1	238 000	375 000	17.1	1 000	1 200	6876
	520	65	4	325 000	510 000	16.6	950	1 200	6976
	560	82	5	455 000	725 000	15.9	900	1 100	6076
400	500	46	2.1	241 000	390 000	17.2	950	1 200	6880
	540	65	4	335 000	540 000	16.7	900	1 100	6980
	600	90	5	510 000	825 000	15.7	850	1 000	6080
420	520	46	2.1	245 000	410 000	17.3	900	1 100	6884
	560	65	4	340 000	570 000	16.8	900	1 100	6984
	620	90	5	530 000	895 000	15.8	800	1 000	6084
440	540	46	2.1	248 000	425 000	17.4	900	1 100	6888
	600	74	4	395 000	680 000	16.6	800	1 000	6988
	650	94	6	550 000	965 000	16.0	750	900	6088
460	580	56	3	310 000	550 000	17.1	800	1 000	6892
	620	74	4	405 000	720 000	16.7	800	950	6992
	680	100	6	605 000	1 080 000	15.8	710	850	6092
480	600	56	3	315 000	575 000	17.2	800	950	6896
	650	78	5	450 000	815 000	16.6	750	900	6996
	700	100	6	605 000	1 090 000	15.9	710	850	6096
500	620	56	3	320 000	600 000	17.3	750	900	68/500
	670	78	5	460 000	865 000	16.7	710	850	69/500
	720	100	6	630 000	1 170 000	16.0	670	800	60/500
530	650	56	3	325 000	625 000	17.4	710	850	68/530
	710	82	5	455 000	870 000	16.8	670	800	69/530
	780	112	6	680 000	1 300 000	16.0	600	750	60/530
560	680	56	3	330 000	650 000	17.4	670	800	68/560
	750	85	5	525 000	1 040 000	16.7	600	750	69/560
	820	115	6	735 000	1 500 000	16.2	560	670	60/560
600	730	60	3	355 000	735 000	17.5	600	710	68/600
	800	90	5	550 000	1 160 000	16.9	560	670	69/600
	870	118	6	790 000	1 640 000	16.1	530	630	60/600

Note (1) When heavy axial loads are applied, increase d_0 and decrease D_0 from the above values.

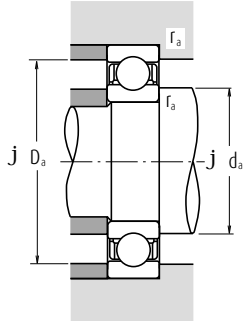

Dynamic Equivalent Load $P=XF_r+YF_a$

$\frac{f_0 F_a}{C_{or}}$	e	$\frac{F_a \leq e}{F_r}$		$\frac{F_a > e}{F_r}$	
		X	Y	X	Y
0.172	0.19	1	0	0.56	2.30
0.345	0.22	1	0	0.56	1.99
0.689	0.26	1	0	0.56	1.71
1.03	0.28	1	0	0.56	1.55
1.38	0.30	1	0	0.56	1.45
2.07	0.34	1	0	0.56	1.31
3.45	0.38	1	0	0.56	1.15
5.17	0.42	1	0	0.56	1.04
6.89	0.44	1	0	0.56	1.00

Static Equivalent Load

$$\frac{F_a}{F_r} > 0.8, P_0 = 0.6F_r + 0.5F_a$$

$$\frac{F_a}{F_r} \leq 0.8, P_0 = F_r$$

Abutment and Fillet Dimensions (mm)			Mass (kg)
d_a (t) min.	D_a (t) max.	r_a max.	approx.
391	469	2	19.5
396	504	3	40
400	540	4	68
411	489	2	20.5
416	524	3	42
420	580	4	88.4
431	509	2	21.4
436	544	3	43.6
440	600	4	92.2
451	529	2	22.3
456	584	3	60.2
466	624	5	106
473	567	2.5	34.3
476	604	3	62.6
486	654	5	123
493	587	2.5	35.4
500	630	4	73.5
506	674	5	127
513	607	2.5	37.2
520	650	4	82
526	694	5	131
543	637	2.5	39.8
550	690	4	89.8
556	754	5	184
573	667	2.5	41.5
580	730	4	105
586	793.5	5	203
613	717	2.5	50.9
620	780	4	120
626	844	5	236

Single-Row Deep Groove Ball Bearings

Bore Diameter 630 – 800 mm

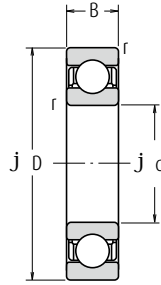

Open Type

Boundary Dimensions (mm)				Basic Load Ratings (N)		Factor	Limiting Speeds (min ⁻¹)		Bearing Numbers
d	D	B	r min.	C _r	C _{0r}	f ₀	Grease	Oil	Open
630	780	69	4	420 000	890 000	17.3	560	670	68/630
	850	100	6	625 000	1 350 000	16.7	530	630	69/630
	920	128	7.5	750 000	1 620 000	16.4	480	600	60/630
670	820	69	4	435 000	965 000	17.4	500	630	68/670
	900	103	6	675 000	1 460 000	16.7	480	560	69/670
	980	136	7.5	765 000	1 730 000	16.6	450	530	60/670
710	870	74	4	480 000	1 100 000	17.4	480	560	68/710
	950	106	6	715 000	1 640 000	16.8	450	530	69/710
750	920	78	5	525 000	1 260 000	17.4	430	530	68/750
	1 000	112	6	785 000	1 840 000	16.7	400	500	69/750
800	980	82	5	530 000	1 310 000	17.5	400	480	68/800
	1 060	115	6	825 000	2 050 000	16.8	380	450	69/800

Note (1) When heavy axial loads are applied, increase d_0 and decrease D_0 from the above values.

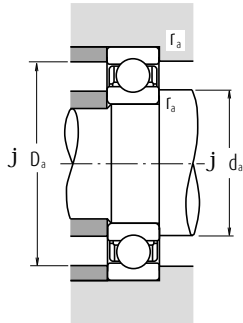

Dynamic Equivalent Load $P = XF_r + YF_a$

$\frac{f_0 F_a}{C_{or}}$	e	$\frac{F_a}{F_r} \leq e$		$\frac{F_a}{F_r} > e$	
		X	Y	X	Y
0.172	0.19	1	0	0.56	2.30
0.345	0.22	1	0	0.56	1.99
0.689	0.26	1	0	0.56	1.71
1.03	0.28	1	0	0.56	1.55
1.38	0.30	1	0	0.56	1.45
2.07	0.34	1	0	0.56	1.31
3.45	0.38	1	0	0.56	1.15
5.17	0.42	1	0	0.56	1.04
6.89	0.44	1	0	0.56	1.00

Static Equivalent Load

$$\frac{F_a}{F_r} > 0.8, P_0 = 0.6F_r + 0.5F_a$$

$$\frac{F_a}{F_r} \leq 0.8, P_0 = F_r$$

Abutment and Fillet Dimensions (mm)			Mass (kg)
d_a (') min.	D_a (') max.	r_a max.	approx.
646	764	3	71.3
656	824	5	163
662	888	6	285
686	804	3	75.4
696	874	5	181
702	948	6	351
726	854	3	92.6
736	924	5	208
770	900	4	110
776	974	5	245
820	960	4	132
826	1034	5	275

Creep-Free Bearings

Bore Diameter 10 – 100 mm

Bearing bore diameter d (mm)	Bearing outer diameter D (mm)	Bearing width B (mm)	Basic load ratings		Recommended fits (1)
			Cr(N)	Cor(N)	
10	26	8	4 550	1 970	H7 or G6
	30	9	5 100	2 390	
	35	11	8 100	3 450	
12	28	8	5 100	2 370	
	32	10	6 800	3 050	
	37	12	9 700	4 200	
15	32	9	5 600	2 830	
	35	11	7 650	3 750	
	42	13	11 400	5 450	
17	35	10	6 000	3 250	
	40	12	9 550	4 800	
	47	14	13 600	6 650	
20	42	12	9 400	5 000	
	47	14	12 800	6 600	
	52	15	15 900	7 900	
25	47	12	10 100	5 850	
	52	15	14 000	7 850	
	62	17	20 600	11 200	
30	55	13	13 200	8 300	
	62	16	19 500	11 300	
	72	19	26 700	15 000	
35	62	14	16 000	10 300	
	72	17	25 700	15 300	
	80	21	33 500	19 200	
40	68	15	16 800	11 500	
	80	18	29 100	17 900	
	90	23	40 500	24 000	
45	75	16	20 900	15 200	
	85	19	31 500	20 400	
	100	25	53 000	32 000	
50	80	16	21 800	16 600	
	90	20	35 000	23 200	
	110	27	62 000	38 500	
55	90	18	28 300	21 200	
	100	21	43 500	29 300	
	120	29	71 500	44 500	
60	95	18	29 500	23 200	
	110	22	52 500	36 000	
	130	31	82 000	52 000	
65	100	18	30 500	25 200	
	120	23	57 500	40 000	
	140	33	92 500	60 000	
70	110	20	38 000	31 000	
	125	24	62 000	44 000	
	150	35	104 000	68 000	
75	115	20	39 500	33 500	
	130	25	66 000	49 500	
	125	22	47 500	40 000	
80	140	26	72 500	53 000	
	130	22	49 500	43 000	
	150	28	84 000	62 000	
90	140	24	58 000	50 000	
95	145	24	60 500	54 000	
100	150	24	60 000	54 000	

Notes (1) Although recommended fits are H7 or G6. G6 is recommended when used under conditions that prioritize insertion under light preload.

(2) Low-contact seal available for seal type bearings. Contact NSK for details.

Bearing number			
Basic number(Open type)	Shield type	Contact seal type (2)	Non-contact seal type
6000 6200 6300	ZZ	DDU	VV
6001 6201 6301	ZZ	DDU	VV
6002 6202 6302	ZZ	DDU	VV
6003 6203 6303	ZZ	DDU	VV
6004 6204 6304	ZZ	DDU	VV
6005 6205 6305	ZZ	DDU	VV
6006 6206 6306	ZZ	DDU	VV
6007 6207 6307	ZZ	DDU	VV
6008 6208 6308	ZZ	DDU	VV
6009 6209 6309	ZZ	DDU	VV
6010 6210 6310	ZZ	DDU	VV
6011 6211 6311	ZZ	DDU	VV
6012 6212 6312	ZZ	DDU	VV
6013 6213 6313	ZZ	DDU	VV
6014 6214 6314	ZZ	DDU	VV
6015 6215	ZZ	DDU	VV
6016 6216	ZZ	DDU	VV
6017 6217	ZZ	DDU	VV
6018	ZZ	DDU	VV
6019	ZZ	DDU	VV
6020	ZZ	DDU	VV

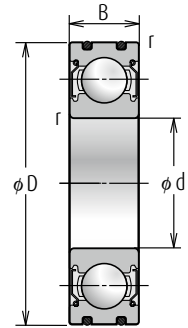

Deep Groove Ball Bearings

Double Row | Bore 10 - 90 mm

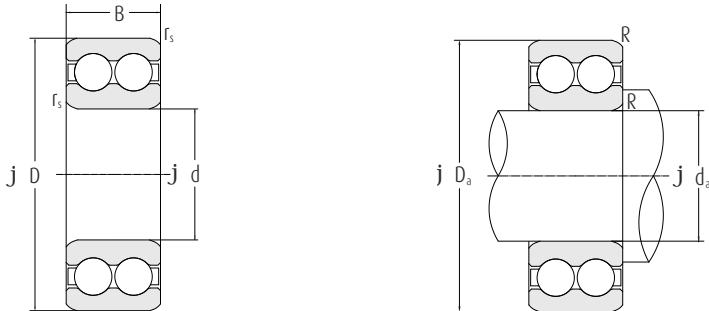

Dimensions				Abbreviation	Load ratings	
d	D	B	r _s min		dyn. C	stat. C ₀
mm				kN		
10	30	14	0.6	4200BTNG	9.15	5.2
12	32	14	0.6	4201BTNG	9.30	5.5
15	35	14	0.6	4202BTNG	10.4	6.7
	42	17	1.0	4302BTNG	14.6	9.2
17	40	16	0.6	4203BTNG	14.6	9.5
	47	19	1.0	4303BTNG	19.6	13.2
20	47	18	1.0	4204BTNG	18.0	12.7
	52	21	1,1	4304BTNG	23.2	16.0
25	52	18	1.0	4205BTNG	19.3	14.6
	62	24	1.1	4305BTNG	31.5	22.4
30	62	20	1.0	4206BTNG	26.0	20.8
	72	27	1.1	4306BTNG	40.0	30.5
35	72	23	1.1	4207BTNG	32.0	26.0
	80	31	1.5	4307BTNG	51.0	38.0
40	80	23	1.1	4208BTNG	34.0	30.0
	90	33	1.5	4308BTNG	63.0	48.0
45	85	23	1.1	4209BTNG	36.0	33.5
	100	36	1.5	4309BTNG	72.0	60.0
50	90	23	1.1	4210BTNG	37.5	36.5
	110	40	2.0	4310BTNG	90.0	75.0
55	100	25	1.5	4211BTNG	43.0	43.0
	120	43	2.0	4311BTNG	104.0	90.0
60	110	28	1.5	4212BTNG	57.0	58.5
	130	46	2.1	4312BTNG	120.0	106.0
65	120	31	1.5	4213BTNG	67.0	67.0
	140	48	2.1	4313BTNG	129.0	98.0
70	125	31	1.5	4214BTNG	69.5	73.5
	150	51	2.1	4314BTNG	146.0	114.0
75	130	31	1.5	4215BTNG	73.5	80.0
	160	55	2.1	4315BTNG	170.0	134.0
80	140	33	2.0	4216BTNG	80.0	90.0
85	150	36	2.0	4217BTNG	93.0	106.0
90	160	40	2.0	4218BTNG	112.0	122.0



Speed limits		Abutment dimensions			Weight
Grease	Oil	d ₀ min	D ₀ max	R min	kg
min ⁻¹					
18 000	24 000	14.0	26.0	0.6	0.049
16 000	20 000	16.0	28.0	0.6	0.053
14 000	18 000	19.0	31.0	0.6	0.059
13 000	17 000	20.0	37.0	1.0	0.120
13 000	18 000	21.0	36.0	1.0	0.090
11 000	17 000	22.0	42.0	1.0	0.160
10 000	14 000	25.0	42.0	1.0	0.140
9 500	13 000	26.5	45.5	1.0	0.210
9 000	12 000	30.0	47.0	1.0	0.160
8 000	10 000	31.5	55.5	1.0	0.340
7 500	9 500	35.0	57.0	1.0	0.260
6 700	8 500	36.5	65.5	1.0	0.500
6 700	8 500	41.5	65.5	1.0	0.400
6 300	8 000	43.0	72.0	1.5	0.690
6 000	7 500	46.5	73.5	1.0	0.500
5 600	7 000	48.0	82.0	1.5	0.950
5 600	7 000	51.5	78.5	1.0	0.540
4 800	6 000	53.0	92.0	1.5	1.250
5 000	6 300	56.5	83.5	1.0	0.580
4 300	5 300	59.0	101.0	2.0	1.700
4 500	5 600	63.0	92.0	1.5	0.800
4 000	5 000	64.0	111.0	2.0	2.150
4 000	5 000	68.0	102.0	1.5	1.100
3 600	4 500	71.0	119.0	2.0	2.650
3 800	4 800	73.0	112.0	1.5	1.450
3 600	4 500	76.0	129.0	2.0	3.250
3 600	4 500	78.0	117.0	1.5	1.500
3 200	4 000	81.0	139.0	2.0	3.950
3 400	4 300	83.0	122.0	1.5	1.600
3 000	3 800	86.0	149.0	2.0	5.380
3 200	4 000	89.0	131.0	2.0	2.000
3 000	3 800	94.0	141.0	2.0	2.550
2 800	3 600	99.0	151.0	2.0	3.200

Maximum Type Ball Bearings

Bore Diameter 25 – 110 mm

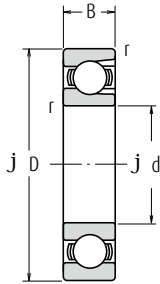

Open Type



Shielded Type
(One Shield) Z



Shielded Type
(Two Shields) ZZ

Boundary Dimensions (mm)				Basic Load Ratings (N)		Limiting Speeds (min ⁻¹)		
d	D	B	r min.	C _r	C _{0r}	Grease		Open
						Open Z - ZZ	Oil Open Z	
25	52	15	1	14 400	10 500	12 000	15 000	BL 205
	62	17	1.1	21 500	15 500	11 000	13 000	BL 305
30	62	16	1	21 000	16 300	10 000	12 000	BL 206
	72	19	1.1	27 900	20 700	9 000	11 000	BL 306
35	72	17	1.1	27 800	22 100	9 000	11 000	BL 207
	80	21	1.5	37 000	29 100	8 000	9 500	BL 307
40	80	18	1.1	35 500	28 800	8 000	9 500	BL 208
	90	23	1.5	46 500	36 000	7 500	9 000	BL 308
45	85	19	1.1	37 000	32 000	7 500	9 000	BL 209
	100	25	1.5	55 500	44 000	6 300	8 000	BL 309
50	90	20	1.1	39 000	35 000	6 700	8 500	BL 210
	110	27	2	65 000	52 500	6 000	7 100	BL 310
55	100	21	1.5	48 000	44 000	6 300	7 500	BL 211
	120	29	2	75 000	61 500	5 600	6 700	BL 311
60	110	22	1.5	58 000	54 000	5 600	6 700	BL 212
	130	31	2.1	85 500	71 500	5 000	6 000	BL 312
65	120	23	1.5	63 500	60 000	5 300	6 300	BL 213
	140	33	2.1	103 000	89 500	4 800	5 600	BL 313
70	125	24	1.5	69 000	66 000	5 000	6 000	BL 214
	150	35	2.1	115 000	102 000	4 300	5 300	BL 314
75	130	25	1.5	72 000	72 000	4 500	5 600	BL 215
	160	37	2.1	126 000	116 000	4 000	5 000	BL 315
80	140	26	2	84 000	85 000	4 300	5 300	BL 216
	170	39	2.1	136 000	130 000	3 800	4 500	BL 316
85	150	28	2	93 000	93 000	4 000	5 000	BL 217
	180	41	3	147 000	145 000	3 600	4 300	BL 317
90	160	30	2	107 000	107 000	3 800	4 500	BL 218
	190	43	3	158 000	161 000	3 400	4 000	BL 318
95	170	32	2.1	121 000	123 000	3 600	4 300	BL 219
	200	45	3	169 000	178 000	2 800	3 600	BL 319
100	180	34	2.1	136 000	140 000	3 400	4 000	BL 220
	105	190	36	148 000	157 000	3 200	3 800	BL 221
110	200	38	2.1	160 000	176 000	2 800	3 400	BL 222

Remark When using Maximum Type Ball Bearings, please contact NSK.

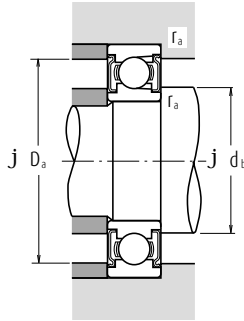
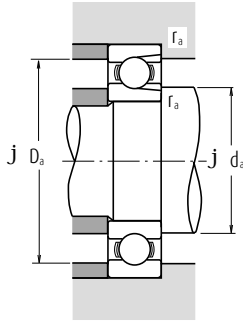

Bearing Numbers		Abutment and Fillet Dimensions (mm)				Mass (kg)
With One Shielded	With Two Shields	d_a min.	d_b max.	D_a max.	r_a max.	approx.
BL 205 Z	BL 205 ZZ	30	32	47	1	0.133
BL 305 Z	BL 305 ZZ	31.5	36	55.5	1	0.246
BL 206 Z	BL 206 ZZ	35	38.5	57	1	0.215
BL 306 Z	BL 306 ZZ	36.5	42	65.5	1	0.364
BL 207 Z	BL 207 ZZ	41.5	44.5	65.5	1	0.307
BL 307 Z	BL 307 ZZ	43	44.5	72	1.5	0.486
BL 208 Z	BL 208 ZZ	46.5	50	73.5	1	0.394
BL 308 Z	BL 308 ZZ	48	52.5	82	1.5	0.685
BL 209 Z	BL 209 ZZ	51.5	55.5	78.5	1	0.449
BL 309 Z	BL 309 ZZ	53	61.5	92	1.5	0.883
BL 210 Z	BL 210 ZZ	56.5	60	83.5	1	0.504
BL 310 Z	BL 310 ZZ	59	68	101	2	1.16
BL 211 Z	BL 211 ZZ	63	66.5	92	1.5	0.667
BL 311 Z	BL 311 ZZ	64	72.5	111	2	1.49
BL 212 Z	BL 212 ZZ	68	74.5	102	1.5	0.856
BL 312 Z	BL 312 ZZ	71	79	119	2	1.88
BL 213 Z	BL 213 ZZ	73	80	112	1.5	1.09
BL 313 Z	BL 313 ZZ	76	85.5	129	2	2.36
BL 214 Z	BL 214 ZZ	78	84	117	1.5	1.19
BL 314 Z	BL 314 ZZ	81	92	139	2	2.87
BL 215 Z	BL 215 ZZ	83	90	122	1.5	1.29
BL 315 Z	BL 315 ZZ	86	98.5	149	2	3.43
BL 216 Z	BL 216 ZZ	89	95.5	131	2	1.61
BL 316 Z	BL 316 ZZ	91	104.5	159	2	4.08
BL 217 Z	BL 217 ZZ	94	102	141	2	1.97
BL 317 Z	BL 317 ZZ	98	110.5	167	2.5	4.77
BL 218 Z	BL 218 ZZ	99	107.5	151	2	2.43
BL 318 Z	BL 318 ZZ	103	117	177	2.5	5.45
BL 219 Z	BL 219 ZZ	106	114	159	2	2.95
BL 319 Z	BL 319 ZZ	108	124	187	2.5	6.4
BL 220 Z	BL 220 ZZ	111	121.5	169	2	3.54
BL 221 Z	BL 221 ZZ	116	127.5	179	2	4.23
—	—	121	—	189	2	4.84

Magneto Bearings

Bore Diameter 4 – 20 mm

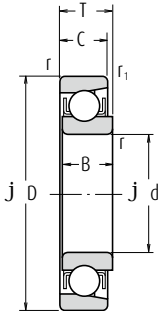

Outside Diameter Tolerance (Class N) Units: μm

Nominal Outside Diameter D (mm)		Single Plane Mean Outside Diameter & D_{mp}			
		E Series		EN Series	
Over	Incl.	High	Low	High	Low
—	10	+8	0	0	-8
10	18	+8	0	0	-8
18	30	+9	0	0	-9
30	50	+11	0	0	-11

Boundary Dimensions (mm)					Basic Load Ratings (N)		Limiting Speeds (min ⁻¹)		Bearing Numbers	
d	D	B,C,T	r min.	r ₁ min.	C _r	C _{0r}	Grease	Oil	E Series	EN Series
4	16	5	0.15	0.1	1 650	288	34 000	40 000	E 4	EN 4
5	16	5	0.15	0.1	1 650	288	34 000	40 000	E 5	EN 5
6	21	7	0.3	0.15	2 490	445	30 000	36 000	E 6	EN 6
7	22	7	0.3	0.15	2 490	445	30 000	36 000	E 7	EN 7
8	24	7	0.3	0.15	3 450	650	28 000	34 000	E 8	EN 8
9	28	8	0.3	0.15	4 550	880	24 000	30 000	E 9	EN 9
10	28	8	0.3	0.15	4 550	880	24 000	30 000	E 10	EN 10
11	32	7	0.3	0.15	4 400	845	22 000	26 000	E 11	EN 11
12	32	7	0.3	0.15	4 400	845	22 000	26 000	E 12	EN 12
13	30	7	0.3	0.15	4 400	845	22 000	26 000	E 13	EN 13
14	35	8	0.3	0.15	5 800	1 150	19 000	22 000	—	EN 14
15	35	8	0.3	0.15	5 800	1 150	19 000	22 000	E 15	EN 15
	40	10	0.6	0.3	7 400	1 500	17 000	20 000	BO 15	—
16	38	10	0.6	0.2	6 900	1 380	17 000	22 000	—	EN 16
17	40	10	0.6	0.3	7 400	1 500	17 000	20 000	L 17	—
	44	11	0.6	0.3	7 350	1 500	16 000	19 000	—	EN 17
	44	11	0.6	0.3	7 350	1 500	16 000	19 000	BO 17	—
18	40	9	0.6	0.2	5 050	1 030	17 000	20 000	—	EN 18
19	40	9	0.6	0.2	5 050	1 030	17 000	20 000	E 19	EN 19
20	47	12	1	0.6	11 000	2 380	14 000	17 000	E 20	EN 20
	47	14	1	0.6	11 000	2 380	14 000	17 000	L 20	—

- Remarks**
1. The outside diameters of Magneto Bearings Series E always have plus tolerances.
 2. When using Magneto Bearings other than E, please contact NSK.

Dynamic Equivalent Load $P=XF_r+YF_a$

$F_a/F_r \leq e$		$F_a/F_r > e$		e
X	Y	X	Y	
1	0	0.5	2.5	0.2

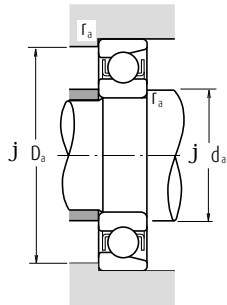

Abutment and Fillet Dimensions (mm)			Mass (kg)
d_a min.	D_a max.	r_a max.	approx.
5.2	14.8	0.15	0.005
6.2	14.8	0.15	0.004
8	19	0.3	0.011
9	20	0.3	0.013
10	22	0.3	0.014
11	26	0.3	0.022
12	26	0.3	0.021
13	30	0.3	0.029
14	30	0.3	0.028
15	28	0.3	0.021
16	33	0.3	0.035
17	33	0.3	0.034
19	36	0.6	0.055
20	34	0.6	0.049
21	36	0.6	0.051
21	40	0.6	0.080
21	40	0.6	0.080
22	36	0.6	0.051
23	36	0.6	0.049
25	42	1	0.089
25	42	1	0.101

Extra Small Ball Bearings and Miniature Ball Bearings

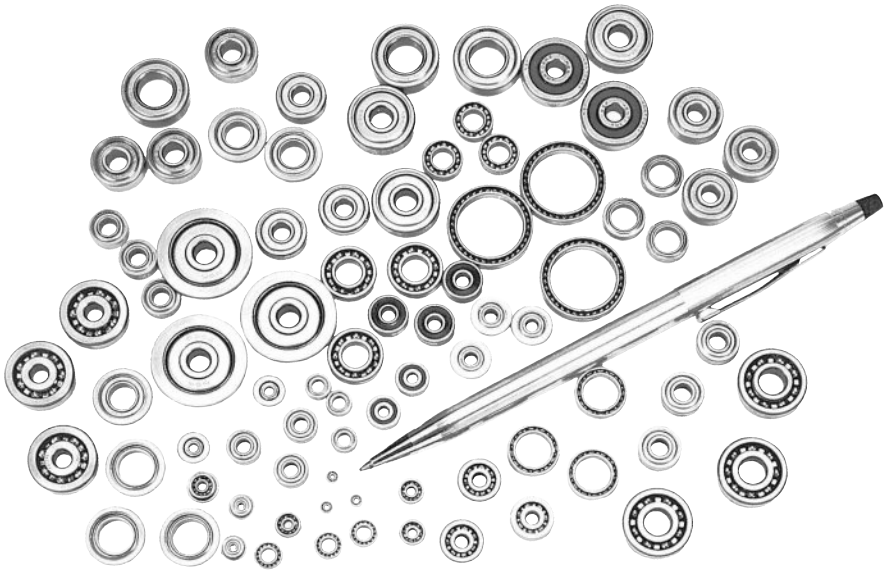

2. EXTRA SMALL BALL BEARINGS AND MINIATURE BALL BEARINGS

INTRODUCTION	B 056
BEARINGS TABLE	

EXTRA SMALL BALL BEARINGS · MINIATURE BALL BEARINGS

	Bore Dia.	Page
Metric Design		
With Flange	1 – 9 mm	B 060
	1 – 9 mm	B 064
Inch Design		
With Flange	1.016 – 9.525 mm.....	B 068
	1.191 – 9.525 mm.....	B 070



Extra Small Ball Bearings and Miniature Ball Bearings

DESIGN AND TYPES

The size ranges of extra small and miniature ball bearings are shown in Table 1. The design, types, and type symbols are shown in Table 2. Those types among them that are listed in the bearing tables are indicated by the shading in Table 2.

Table 1 Size Ranges of Bearings

Units : mm

Design	Extra Small Ball Bearings	Miniature Ball Bearings
Metric	Outside diameter D < 9 Bore diameter d < 10	Outside diameter D < 9
Inch	Outside diameter D < 9.525 Bore diameter d < 10	Outside diameter D < 9.525

Please refer to NSK Miniature Ball Bearings (CAT. No. E126) for details.

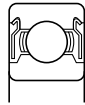

ZZ

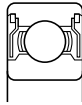

ZS

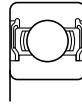



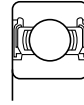

DD



W

Table 2 Design, Types, and Type Symbols

Design · Types		Type Symbols				Remarks
		Metric	Inch	Special		
				Metric	Inch	
Single-Row Deep Groove Ball Bearings		6 f f	R	MR	—	Shielded - sealed bearings are available.
	Thin section	—	—	SMT	—	
		F6 f f	FR	MF	—	Shielded - sealed bearings are available.
	Extended inner ring	—	—	—	RW	Shielded bearings are available.
	With flange and extended inner ring	—	—	—	FRW	Shielded bearings are available.
	For synchro motors	—	—	—	SR00X00	Shielded bearings are available.
Pivot Ball Bearings		—	—	BCF	—	
Thrust Ball Bearings		—	—	F	—	

Remark Single-row angular contact ball bearings are available besides those shown above.

Extra Small Ball Bearings and Miniature Ball Bearings

TOLERANCES AND RUNNING ACCURACY

Metric Design Bearings

The flange tolerances for metric design bearings are listed in Table 3.

Table

7.3 A132 to A135

Pages

A132 to A135

Table 3 Flange Tolerances for Metric Flanged Bearings

(1) Tolerances of Flange Outside Diameter

Units : μm

Nominal Flange Outside Diameter $D_1(\text{mm})$		Deviation of Flange Outside Diameter & D_{15}			
		①		②	
over	incl.	high	low	high	low
	10	+220	-36	0	-36
10	18	+270	-43	0	-43
18	30	+330	-52	0	-52

Remark ② is applied when the flange outside diameter is used for positioning.

(2) Flange Width Tolerances and Running Accuracies Related to Flange

Units : μm

Nominal Bearing Outside Diameter $D(\text{mm})$		Deviation of Flange Width & C_{15}	Variation of Flange Width & C_{15} VC_{15}				Variation of Bearing Outside Surface Generatrix Inclination with Flange Backface S_{D1}			Flange Backface Runout with Raceway S_{ea1}		
			Normal and Class 6	Class 5	Class 4	Class 2	Class 5	Class 4	Class 2	Class 5	Class 4	Class 2
over	incl.	high	low	max.			max.			max.		
2.5 ⁽¹⁾	6	Use the & B_S tolerance for d of the same bearing of the same class	Use the & V_{BS} tolerance for d of the same bearing of the same class	5	2.5	1.5	8	4	1.5	11	7	3
6	18			5	2.5	1.5	8	4	1.5	11	7	3
18	30			5	2.5	1.5	8	4	1.5	11	7	3

Note (1) 2.5 mm is included

Inch Design Bearings

The flange tolerances for inch design flanged bearings are listed in Table 7.9 (2) (Pages A146 and A147).

Table

7.4 A136 to A137

Pages

A136 to A137

Instrument Ball Bearings

7.9 A146 to A147

RECOMMENDED FITS

Please refer to NSK Miniature Ball Bearings (CAT.No.E126).

INTERNAL CLEARANCES

Table

8.11 A169

Page

A169

LIMITING SPEEDS

The limiting speeds listed in the bearing tables should be adjusted depending on the bearing load conditions. Also, higher speeds are attainable by making changes in the lubrication method, cage design, etc. Refer to Page A098 for detailed information.



Extra Small Ball Bearings · Miniature Ball Bearings

Metric Design Bore Diameter 1 – 4 mm

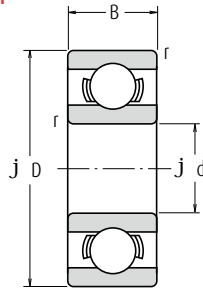

Open Type

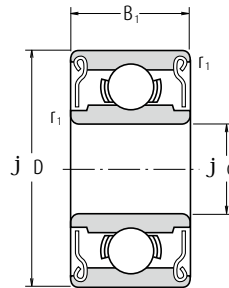

Shielded Type
ZZ · ZZ1

Boundary Dimensions (mm)						Basic Load Ratings (N)		Limiting Speeds (min ⁻¹)		
d	D	B	B ₁	r ⁽¹⁾ min.	r ₁ ⁽¹⁾ min.	C _r	C _{0r}	Grease		Open
								Open Z · ZZ	Oil Open Z	
1	3	1	—	0.05	—	80	23	130 000	150 000	681
	3	1.5	—	0.05	—	80	23	130 000	150 000	MR 31
	4	1.6	—	0.1	—	138	35	100 000	120 000	691
1.2	4	1.8	2.5	0.1	0.1	138	35	110 000	130 000	MR 41 X
	4	1.2	2	0.05	0.05	112	33	100 000	120 000	681 X
1.5	5	2	2.6	0.15	0.15	237	69	85 000	100 000	691 X
	6	2.5	3	0.15	0.15	330	98	75 000	90 000	601 X
	5	1.5	2.3	0.08	0.08	169	50	85 000	100 000	682
2	5	2	2.5	0.1	0.1	187	58	85 000	100 000	MR 52 B
	6	2.3	3	0.15	0.15	330	98	75 000	90 000	692
	6	2.5	2.5	0.15	0.15	330	98	75 000	90 000	MR 62
	7	2.5	3	0.15	0.15	385	127	63 000	75 000	MR 72
	7	2.8	3.5	0.15	0.15	385	127	63 000	75 000	602
	6	1.8	2.6	0.08	0.08	208	74	71 000	80 000	682 X
2.5	7	2.5	3.5	0.15	0.15	385	127	63 000	75 000	692 X
	8	2.5	—	0.2	—	560	179	60 000	67 000	MR 82 X
	8	2.8	4	0.15	0.15	550	175	60 000	71 000	602 X
3	6	2	2.5	0.1	0.1	208	74	71 000	80 000	MR 63
	7	2	3	0.1	0.1	390	130	63 000	75 000	683 A
	8	2.5	—	0.15	—	560	179	60 000	67 000	MR 83
	8	3	4	0.15	0.15	560	179	60 000	67 000	693
	9	2.5	4	0.2	0.15	570	187	56 000	67 000	MR 93
	9	3	5	0.15	0.15	570	187	56 000	67 000	603
	10	4	4	0.15	0.15	630	218	50 000	60 000	623
4	13	5	5	0.2	0.2	1 300	485	40 000	48 000	633
	7	2	—	0.1	—	310	115	60 000	67 000	MR 74
	7	—	2.5	—	0.1	255	107	60 000	71 000	—
	8	2	3	0.15	0.1	395	139	56 000	67 000	MR 84
	9	2.5	4	(0.15)	(0.15)	640	225	53 000	63 000	684 A
	10	3	4	0.2	0.15	710	270	50 000	60 000	MR 104 B
	11	4	4	0.15	0.15	960	345	48 000	56 000	694
12	4	4	0.2	0.2	960	345	48 000	56 000	604	
13	5	5	0.2	0.2	1 300	485	40 000	48 000	624	
	16	5	5	0.3	0.3	1 730	670	36 000	43 000	634

Note (1) The values in parentheses are not based on ISO 15.

Remark When using bearings with a rotating outer ring, please contact NSK if they are shielded.

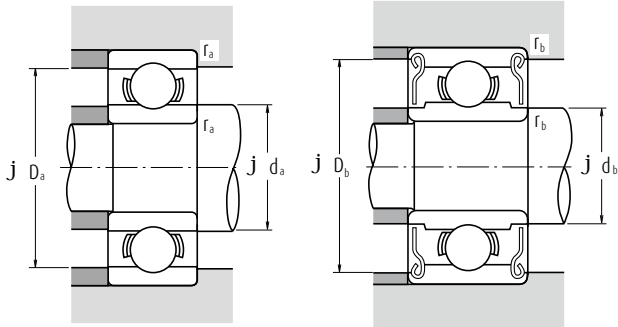

Radial and axial load factors

C_{0r}/F_a	$F_a/F_r \leq e$		$F_a/F_r > e$		e
	X	Y	X	Y	
5	1	0	0.56	1.26	0.35
10	1	0	0.56	1.49	0.29
15	1	0	0.56	1.64	0.27
20	1	0	0.56	1.76	0.25
25	1	0	0.56	1.85	0.24
30	1	0	0.56	1.92	0.23
50	1	0	0.56	2.13	0.20



Bearing Numbers		Abutment and Fillet Dimensions (mm)						Mass (g)	
Shielded	Sealed	d_a	d_b	D_a	D_b	r_a	r_b	approx.	
		min.	max.	max.	min.	max.	max.	Open	Shielded
—	—	1.4	—	2.6	—	0.05	—	0.03	—
—	—	1.4	—	2.6	—	0.05	—	0.04	—
—	—	1.8	—	3.2	—	0.1	—	0.09	—
MR 41 XZZ	—	2.0	1.9	3.2	3.5	0.1	0.1	0.10	0.14
681 XZZ	—	1.9	2.1	3.6	3.6	0.05	0.05	0.07	0.11
691 XZZ	—	2.7	2.5	3.8	4.3	0.15	0.15	0.17	0.20
601 XZZ	—	2.7	3.0	4.8	5.4	0.15	0.15	0.33	0.38
682 ZZ	—	2.6	2.7	4.4	4.2	0.08	0.08	0.12	0.17
MR 52 BZZ	—	2.8	2.7	4.2	4.4	0.1	0.1	0.16	0.23
692 ZZ	—	3.2	3.0	4.8	5.4	0.15	0.15	0.28	0.38
MR 62 ZZ	—	3.2	3.0	4.8	5.2	0.15	0.15	0.30	0.29
MR 72 ZZ	—	3.2	3.8	5.8	6.2	0.15	0.15	0.45	0.49
602 ZZ	—	3.2	3.8	5.8	6.2	0.15	0.15	0.51	0.58
682 XZZ	—	3.1	3.7	5.4	5.4	0.08	0.08	0.23	0.29
692 XZZ	—	3.7	3.8	5.8	6.2	0.15	0.15	0.41	0.55
—	—	4.1	—	6.4	—	0.2	—	0.56	—
602 XZZ	—	3.7	4.1	6.8	7.0	0.15	0.15	0.63	0.83
MR 63 ZZ	—	3.8	3.7	5.2	5.4	0.1	0.1	0.20	0.27
683 AZZ	—	3.8	4.0	6.2	6.4	0.1	0.1	0.32	0.45
—	—	4.2	—	6.8	—	0.15	—	0.54	—
693 ZZ	—	4.2	4.3	6.8	7.3	0.15	0.15	0.61	0.83
MR 93 ZZ	—	4.6	4.3	7.4	7.9	0.2	0.15	0.73	1.18
603 ZZ	—	4.2	4.3	7.8	7.9	0.15	0.15	0.87	1.45
623 ZZ	—	4.2	4.3	8.8	8.0	0.15	0.15	1.65	1.66
633 ZZ	—	4.6	6.0	11.4	11.3	0.2	0.2	3.38	3.33
—	—	4.8	—	6.2	—	0.1	—	0.22	—
MR 74 ZZ	—	—	4.8	—	6.3	—	0.1	—	0.29
MR 84 ZZ	—	5.2	5.0	6.8	7.4	0.15	0.1	0.36	0.56
684 AZZ	—	4.8	5.2	8.2	8.1	0.1	0.1	0.63	1.01
MR 104 BZZ	—	5.6	5.9	8.4	8.8	0.2	0.15	1.04	1.42
694 ZZ	—	5.2	5.6	9.8	9.9	0.15	0.15	1.7	1.75
604 ZZ	—	5.6	5.6	10.4	9.9	0.2	0.2	2.25	2.29
624 ZZ	—	5.6	6.0	11.4	11.3	0.2	0.2	3.03	3.04
634 ZZ1	—	6.0	7.5	14.0	13.8	0.3	0.3	5.24	5.21

Extra Small Ball Bearings · Miniature Ball Bearings

Metric Design Bore Diameter 5 – 9 mm

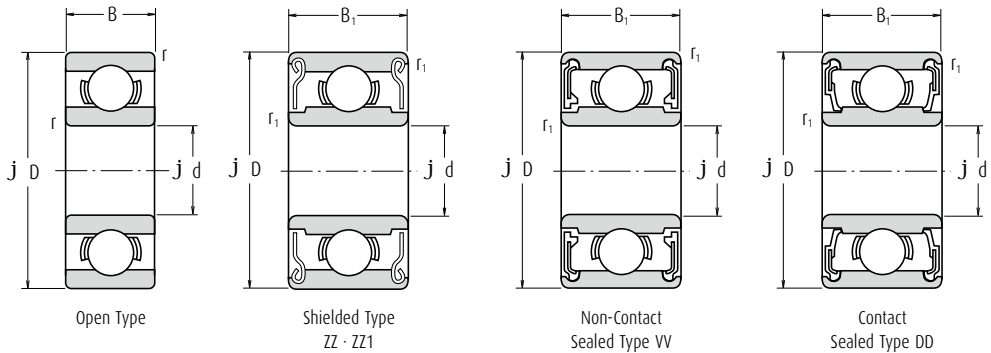

d	Boundary Dimensions (mm)				Basic Load Ratings (N)		Limiting Speeds (min ⁻¹)					
	D	B	B ₁	r ⁽¹⁾ min.	r ₁ ⁽¹⁾ min.	C _r	C _{0r}	Grease		Oil		
								Open Z · ZZ V · VV	D · DD	Open Z	Open	
5	8	2	—	0.1	—	310	120	53 000	—	63 000	MR 85	
	8	—	2.5	—	0.1	278	131	53 000	—	63 000	—	
	9	2.5	3	0.15	0.15	430	168	50 000	—	60 000	MR 95	
	10	3	4	0.15	0.15	430	168	50 000	—	60 000	MR 105	
	11	—	4	—	0.15	715	276	48 000	—	56 000	—	
	11	3	5	0.15	0.15	715	281	45 000	—	53 000	685	
	13	4	4	0.2	0.2	1 080	430	43 000	40 000	50 000	695	
	14	5	5	0.2	0.2	1 330	505	40 000	38 000	50 000	605	
	16	5	5	0.3	0.3	1 730	670	36 000	32 000	43 000	625	
	19	6	6	0.3	0.3	2 340	885	32 000	30 000	40 000	635	
6	10	2.5	3	0.15	0.1	495	218	45 000	—	53 000	MR 106	
	12	3	4	0.2	0.15	715	292	43 000	40 000	50 000	MR 126	
	13	3.5	5	0.15	0.15	1 080	440	40 000	38 000	50 000	686 A	
	15	5	5	0.2	0.2	1 730	670	40 000	36 000	45 000	696	
	17	6	6	0.3	0.3	2 260	835	38 000	34 000	45 000	606	
	19	6	6	0.3	0.3	2 340	885	32 000	30 000	40 000	626	
	22	7	7	0.3	0.3	3 300	1 370	30 000	28 000	36 000	636	
	26	9	9	0.3	0.3	4 550	1 970	28 000	22 000	34 000	637	
7	11	2.5	3	0.15	0.1	455	201	43 000	—	50 000	MR 117	
	13	3	4	0.2	0.15	540	276	40 000	—	48 000	MR 137	
	14	3.5	5	0.15	0.15	1 170	510	40 000	34 000	45 000	687	
	17	5	5	0.3	0.3	1 610	710	36 000	28 000	43 000	697	
	19	6	6	0.3	0.3	2 340	885	36 000	32 000	43 000	607	
	22	7	7	0.3	0.3	3 300	1 370	30 000	28 000	36 000	627	
	26	9	9	0.3	0.3	4 550	1 970	28 000	22 000	34 000	637	
	28	9	9	0.3	0.3	4 550	1 970	28 000	22 000	34 000	638	
	30	10	10	0.6	0.6	5 100	2 390	24 000	—	30 000	639	
	8	12	2.5	3.5	0.15	0.1	545	274	40 000	—	48 000	MR 128
14		3.5	4	0.2	0.15	820	385	38 000	32 000	45 000	MR 148	
16		4	5	0.2	0.2	1 610	710	36 000	28 000	43 000	688 A	
19		6	6	0.3	0.3	2 240	910	36 000	28 000	43 000	698	
22		7	7	0.3	0.3	3 300	1 370	34 000	28 000	40 000	608	
24		8	8	0.3	0.3	3 350	1 430	28 000	24 000	34 000	628	
28		9	9	0.3	0.3	4 550	1 970	28 000	22 000	34 000	638	
30		10	10	0.6	0.6	5 100	2 390	24 000	—	30 000	639	
9		17	4	5	0.2	0.2	1 330	665	36 000	24 000	43 000	689
		20	6	6	0.3	0.3	1 720	840	34 000	24 000	40 000	699
	24	7	7	0.3	0.3	3 350	1 430	32 000	24 000	38 000	609	
	26	8	8	(0.6)	(0.6)	4 550	1 970	28 000	22 000	34 000	629	
	30	10	10	0.6	0.6	5 100	2 390	24 000	—	30 000	639	

Note (1) The values in parentheses are not based on ISO 15.

Remarks 1. When using bearings with a rotating outer ring, please contact NSK if they are sealed or shielded.
2. Bearings with snap rings are also available, please contact NSK.

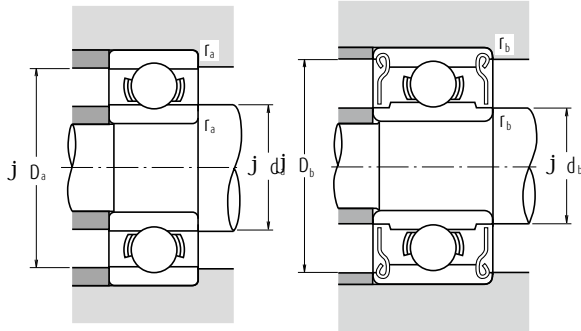

Radial and axial load factors

C_{0r}/F_a	$F_a/F_r \leq e$		$F_a/F_r > e$		e
	X	Y	X	Y	
5	1	0	0.56	1.26	0.35
10	1	0	0.56	1.49	0.29
15	1	0	0.56	1.64	0.27
20	1	0	0.56	1.76	0.25
25	1	0	0.56	1.85	0.24
30	1	0	0.56	1.92	0.23
50	1	0	0.56	2.13	0.20

Bearing Numbers			Abutment and Fillet Dimensions (mm)						Mass (g)	
Shielded	Sealed		d_a	d_b	D_a	D_b	r_a	r_b	approx.	
			min.	max.	max.	min.	max.	max.	Open	Shielded
—	—	—	5.8	—	7.2	—	0.1	—	0.26	—
MR 85 ZZ	—	—	—	5.8	—	7.4	—	0.1	—	0.34
MR 95 ZZ1	—	—	6.2	6.0	7.8	8.2	0.15	0.15	0.50	0.58
MR 105 ZZ	—	—	6.2	6.0	8.8	8.4	0.15	0.15	0.95	1.29
MR 115 ZZ	VV	—	—	6.3	—	9.8	—	0.15	—	1.49
685 ZZ	—	—	6.2	6.2	9.8	9.9	0.15	0.15	1.2	1.96
695 ZZ	VV	DD	6.6	6.6	11.4	11.2	0.2	0.2	2.45	2.5
605 ZZ	—	DD	6.6	6.9	12.4	12.2	0.2	0.2	3.54	3.48
625 ZZ1	VV	DD	7.0	7.5	14.0	13.8	0.3	0.3	4.95	4.86
635 ZZ1	VV	DD	7.0	8.5	17.0	16.5	0.3	0.3	8.56	8.34
MR 106 ZZ1	—	—	7.2	7.0	8.8	9.3	0.15	0.1	0.56	0.68
MR 126 ZZ	—	DD	7.6	7.2	10.4	10.9	0.2	0.15	1.27	1.74
686 AZZ	VV	DD	7.2	7.4	11.8	11.7	0.15	0.15	1.91	2.69
696 ZZ1	VV	DD	7.6	7.9	13.4	13.3	0.2	0.2	3.88	3.72
606 ZZ	VV	DD	8.0	8.2	15.0	14.8	0.3	0.3	5.97	6.08
626 ZZ1	VV	DD	8.0	8.5	17.0	16.5	0.3	0.3	8.15	7.94
636 ZZ	VV	DD	8.0	10.5	20.0	19.0	0.3	0.3	14	14
MR 117 ZZ	—	—	8.2	8.0	9.8	10.5	0.15	0.1	0.62	0.72
MR 137 ZZ	—	—	8.6	9.0	11.4	11.6	0.2	0.15	1.58	2.02
687 ZZ1	VV	DD	8.2	8.5	12.8	12.7	0.15	0.15	2.13	2.97
697 ZZ1	VV	DD	9.0	10.2	15.0	14.8	0.3	0.3	5.26	5.12
607 ZZ1	VV	DD	9.0	9.1	17.0	16.5	0.3	0.3	7.67	7.51
627 ZZ	VV	DD	9.0	10.5	20.0	19.0	0.3	0.3	12.7	12.9
637 ZZ1	VV	DD	9.0	12.8	24.0	22.8	0.3	0.3	24	25
MR 128 ZZ1	—	—	9.2	9.0	10.8	11.3	0.15	0.1	0.71	0.97
MR 148 ZZ	VV	DD	9.6	9.2	12.4	12.8	0.2	0.15	1.86	2.16
688 AZZ1	VV	DD	9.6	10.2	14.4	14.2	0.2	0.2	3.12	4.02
698 ZZ	VV	DD	10.0	10.0	17.0	16.5	0.3	0.3	7.23	7.18
608 ZZ	VV	DD	10.0	10.5	20.0	19.0	0.3	0.3	12.1	12.2
628 ZZ	VV	DD	10.0	12.0	22.0	20.5	0.3	0.3	17.2	17.4
638 ZZ1	VV	DD	10.0	12.8	26.0	22.8	0.3	0.3	28.3	28.6
689 ZZ1	VV	DD	10.6	11.5	15.4	15.2	0.2	0.2	3.53	4.43
699 ZZ1	VV	DD	11.0	12.0	18.0	17.2	0.3	0.3	8.45	8.33
609 ZZ	VV	DD	11.0	12.0	22.8	20.5	0.3	0.3	14.5	14.7
629 ZZ	VV	DD	11.0	12.8	24.0	22.8	0.3	0.3	19.5	19.3
639 ZZ	VV	—	13.0	16.1	26.0	25.6	0.6	0.6	36.5	36

Extra Small Ball Bearings · Miniature Ball Bearings

Metric Design With Flange
Bore Diameter 1 – 4 mm

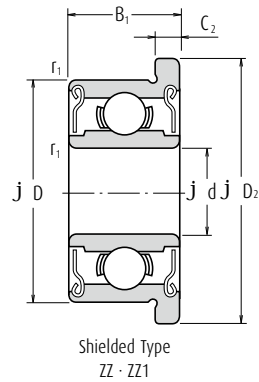
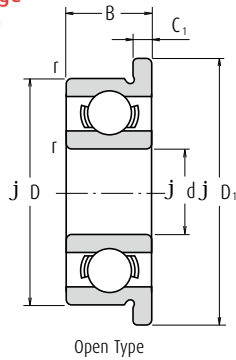

Boundary Dimensions (mm)										Basic Load Ratings (N)		Limiting Speeds (min ⁻¹)	
d	D	D ₁	D ₂	B	B ₁	C ₁	C ₂	r ⁽¹⁾ min.	r ₁ ⁽¹⁾ min.	C _r	C _{0r}	Grease Open Z · ZZ	Oil Open Z
1	3	3.8	—	1	—	0.3	—	0.05	—	80	23	130 000	150 000
	4	5	—	1.6	—	0.5	—	0.1	—	140	36	100 000	120 000
1.2	4	4.8	—	1.8	—	0.4	—	0.1	—	138	35	110 000	130 000
	5	5	5	1.2	2	0.4	0.6	0.05	0.05	112	33	100 000	120 000
1.5	5	6.5	6.5	2	2.6	0.6	0.8	0.15	0.15	237	69	85 000	100 000
	6	7.5	7.5	2.5	3	0.6	0.8	0.15	0.15	330	98	75 000	90 000
	7	8.2	8.2	2.5	3	0.6	0.6	0.15	0.15	385	127	63 000	75 000
2	5	6.1	6.1	1.5	2.3	0.5	0.6	0.08	0.08	169	50	85 000	100 000
	6	7.2	—	2.5	—	0.6	—	0.15	—	330	98	75 000	90 000
	7	8.5	8.5	2.8	3.5	0.7	0.9	0.15	0.15	385	127	63 000	75 000
2.5	6	7.1	7.1	1.8	2.6	0.5	0.8	0.08	0.08	208	74	71 000	80 000
	7	8.5	8.5	2.5	3.5	0.7	0.9	0.15	0.15	385	127	63 000	75 000
	8	9.2	—	2.5	—	0.6	—	0.2	—	560	179	60 000	67 000
3	8	9.5	9.5	2.8	4	0.7	0.9	0.15	0.15	550	175	60 000	71 000
	9	10.2	10.6	2.5	4	0.6	0.8	0.2	0.15	570	187	56 000	67 000
	10	11.5	11.5	4	4	1	1	0.15	0.15	630	218	50 000	60 000
4	7	8.2	—	2	—	0.6	—	0.1	—	310	115	60 000	67 000
	8	9.2	—	2.5	—	0.6	—	0.1	—	255	107	60 000	71 000
	9	10.3	10.3	2.5	4	0.6	1	(0.15)	(0.15)	640	225	53 000	63 000
4	10	11.2	11.6	3	4	0.6	0.8	0.2	0.15	710	270	50 000	60 000
	11	12.5	12.5	4	4	1	1	0.15	0.15	960	345	48 000	56 000
	12	13.5	13.5	4	4	1	1	0.2	0.2	960	345	48 000	56 000
	13	15	15	5	5	1	1	0.2	0.2	1 300	485	40 000	48 000
	16	18	18	5	5	1	1	0.3	0.3	1 730	670	36 000	43 000

Note (1) The values in parentheses are not based on ISO 15.

Remark When using bearings with a rotating outer ring, please contact NSK if they are sealed or shielded.

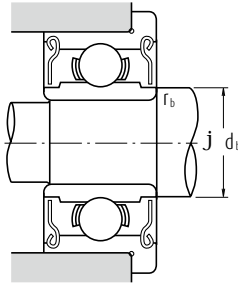
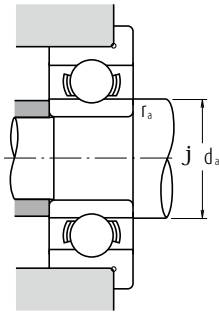

Radial and axial load factors

C_{0r}/F_a	$F_a/F_r \leq e$		$F_a/F_r > e$		e
	X	Y	X	Y	
5	1	0	0.56	1.26	0.35
10	1	0	0.56	1.49	0.29
15	1	0	0.56	1.64	0.27
20	1	0	0.56	1.76	0.25
25	1	0	0.56	1.85	0.24
30	1	0	0.56	1.92	0.23
50	1	0	0.56	2.13	0.20



Bearing Numbers			Abutment and Fillet Dimensions (mm)				Mass (g) approx.	
Open	Shielded	Sealed	d_a min.	d_b max.	r_a max.	r_b max.	Open	Shielded
F 681	—	—	1.4	—	0.05	—	0.04	—
F 691	—	—	1.8	—	0.1	—	0.14	—
MF 41 X	—	—	2.0	—	0.1	—	0.12	—
F 681 X	F 681 XZZ	—	1.9	2.1	0.05	0.05	0.09	0.14
F 691 X	F 691 XZZ	—	2.7	2.5	0.15	0.15	0.23	0.28
F 601 X	F 601 XZZ	—	2.7	3.0	0.15	0.15	0.42	0.52
F 682	F 682 ZZ	—	2.6	2.7	0.08	0.08	0.16	0.22
MF 52 B	MF 52 BZZ	—	2.8	2.7	0.1	0.1	0.21	0.27
F 692	F 692 ZZ	—	3.2	3.0	0.15	0.15	0.35	0.48
MF 62	—	—	3.2	—	0.15	—	0.36	—
MF 72	MF 72 ZZ	—	3.2	3.8	0.15	0.15	0.52	0.56
F 602	F 602 ZZ	—	3.2	3.1	0.15	0.15	0.60	0.71
F 682 X	F 682 XZZ	—	3.1	3.7	0.08	0.08	0.25	0.36
F 692 X	F 692 XZZ	—	3.7	3.8	0.15	0.15	0.51	0.68
MF 82 X	—	—	4.1	—	0.2	—	0.62	—
F 602 X	F 602 XZZ	—	3.7	3.5	0.15	0.15	0.74	0.98
MF 63	MF 63 ZZ	—	3.8	3.7	0.1	0.1	0.27	0.33
F 683 A	F 683 AZZ	—	3.8	4.0	0.1	0.1	0.37	0.53
MF 83	—	—	4.2	—	0.15	—	0.56	—
F 693	F 693 ZZ	—	4.2	4.3	0.15	0.15	0.70	0.97
MF 93	MF 93 ZZ	—	4.6	4.3	0.2	0.15	0.81	1.34
F 603	F 603 ZZ	—	4.2	4.3	0.15	0.15	1.0	1.63
F 623	F 623 ZZ	—	4.2	4.3	0.15	0.15	1.85	1.86
F 633	F 633 ZZ	—	4.6	6.0	0.2	0.2	3.73	3.59
MF 74	—	—	4.8	—	0.1	—	0.29	—
—	MF 74 ZZ	—	—	4.8	—	0.1	—	0.35
MF 84	MF 84 ZZ	—	5.2	5.0	0.15	0.1	0.44	0.63
F 684	F 684 ZZ	—	4.8	5.2	0.1	0.1	0.70	1.14
MF 104 B	MF 104 BZZ	—	5.6	5.9	0.2	0.15	1.13	1.59
F 694	F 694 ZZ	—	5.2	5.6	0.15	0.15	1.91	1.96
F 604	F 604 ZZ	—	5.6	5.6	0.2	0.2	2.53	2.53
F 624	F 624 ZZ	—	5.6	6.0	0.2	0.2	3.38	3.53
F 634	F 634 ZZ1	—	6.0	7.5	0.3	0.3	5.73	5.62

Extra Small Ball Bearings · Miniature Ball Bearings

Metric Design With Flange Bore Diameter 5 – 9 mm

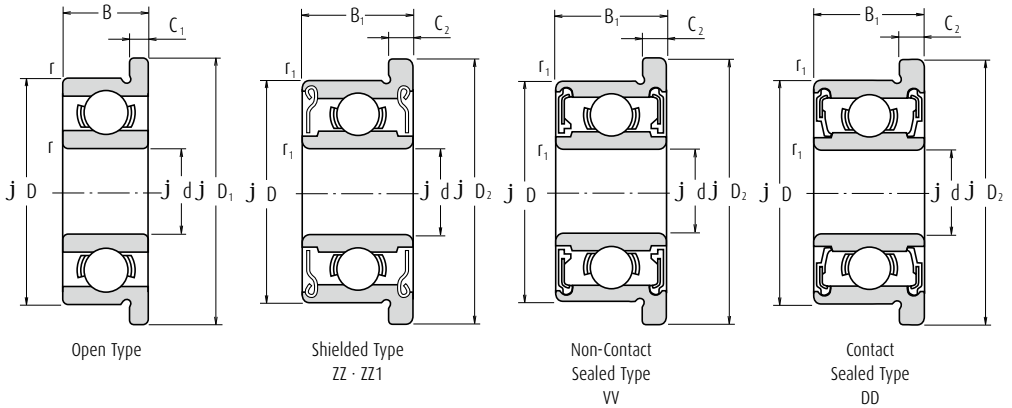

Boundary Dimensions (mm)										Basic Load Ratings (N)		Limiting Speeds (min ⁻¹)		
d	D	D ₁	D ₂	B	B ₁	C ₁	C ₂	r min.	r ₁ min.	C _r	C _{0r}	Grease		Oil
												Open Z · ZZ V · VV	D · DD	Open Z
5	8	9.2	—	2	—	0.6	—	0.1	—	310	120	53 000	—	63 000
	8	—	9.2	—	2.5	—	0.6	—	0.1	278	131	53 000	—	63 000
	9	10.2	10.2	2.5	3	0.6	0.6	0.15	0.15	430	168	50 000	—	60 000
	10	11.2	11.6	3	4	0.6	0.8	0.15	0.15	430	168	50 000	—	60 000
	11	12.5	12.5	3	5	0.8	1	0.15	0.15	715	281	45 000	—	53 000
	13	15	15	4	4	1	1	0.2	0.2	1 080	430	43 000	40 000	50 000
	14	16	16	5	5	1	1	0.2	0.2	1 330	505	40 000	38 000	50 000
	16	18	18	5	5	1	1	0.3	0.3	1 730	670	36 000	32 000	43 000
	19	22	22	6	6	1.5	1.5	0.3	0.3	2 340	885	32 000	30 000	40 000
6	10	11.2	11.2	2.5	3	0.6	0.6	0.15	0.1	495	218	45 000	—	53 000
	12	13.2	13.6	3	4	0.6	0.8	0.2	0.15	715	292	43 000	40 000	50 000
	13	15	15	3.5	5	1	1.1	0.15	0.15	1 080	440	40 000	38 000	50 000
	15	17	17	5	5	1.2	1.2	0.2	0.2	1 730	670	40 000	36 000	45 000
	17	19	19	6	6	1.2	1.2	0.3	0.3	2 260	835	38 000	34 000	45 000
	19	22	22	6	6	1.5	1.5	0.3	0.3	2 340	885	32 000	30 000	40 000
	22	25	25	7	7	1.5	1.5	0.3	0.3	3 300	1 370	30 000	28 000	36 000
7	11	12.2	12.2	2.5	3	0.6	0.6	0.15	0.1	455	201	43 000	—	50 000
	13	14.2	14.6	3	4	0.6	0.8	0.2	0.15	540	276	40 000	—	48 000
	14	16	16	3.5	5	1	1.1	0.15	0.15	1 170	510	40 000	34 000	45 000
	17	19	19	5	5	1.2	1.2	0.3	0.3	1 610	715	36 000	28 000	43 000
	19	22	22	6	6	1.5	1.5	0.3	0.3	2 340	885	36 000	32 000	43 000
	22	25	25	7	7	1.5	1.5	0.3	0.3	3 300	1 370	30 000	28 000	36 000
8	12	13.2	13.6	2.5	3.5	0.6	0.8	0.15	0.1	545	274	40 000	—	48 000
	14	15.6	15.6	3.5	4	0.8	0.8	0.2	0.15	820	385	38 000	32 000	45 000
	16	18	18	4	5	1	1.1	0.2	0.2	1 610	710	36 000	30 000	43 000
	19	22	22	6	6	1.5	1.5	0.3	0.3	2 240	910	36 000	28 000	43 000
	22	25	25	7	7	1.5	1.5	0.3	0.3	3 300	1 370	34 000	28 000	40 000
9	17	19	19	4	5	1	1.1	0.2	0.2	1 330	665	36 000	24 000	43 000
	20	23	23	6	6	1.5	1.5	0.3	0.3	1 720	840	34 000	24 000	40 000

Remark When using bearings with a rotating outer ring, please contact NSK if they are sealed or shielded.

Radial and axial load factors

C_{0r}/F_a	$F_a/F_r \leq e$		$F_a/F_r > e$		e
	X	Y	X	Y	
5	1	0	0.56	1.26	0.35
10	1	0	0.56	1.49	0.29
15	1	0	0.56	1.64	0.27
20	1	0	0.56	1.76	0.25
25	1	0	0.56	1.85	0.24
30	1	0	0.56	1.92	0.23
50	1	0	0.56	2.13	0.20

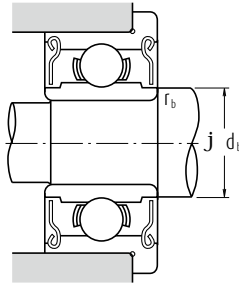
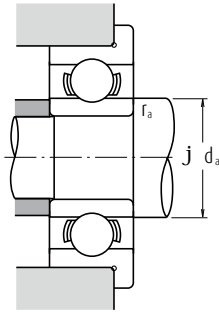

Bearing Numbers			Abutment and Fillet Dimensions (mm)				Mass (g)	
Open	Shielded	Sealed	d_a	d_b	r_a	r_b	approx.	
			min.	max.	max.	max.	Open	Shielded
MF 85	—	—	5.8	—	0.1	—	0.33	—
—	MF 85 ZZ	—	—	5.8	—	0.1	—	0.41
MF 95	MF 95 ZZ1	—	6.2	6.0	0.15	0.15	0.59	0.66
MF 105	MF 105 ZZ	—	6.2	6.0	0.15	0.15	1.05	1.46
F 685	F 685 ZZ	—	6.2	6.2	0.15	0.15	1.37	2.18
F 695	F 695 ZZ	VV DD	6.6	6.6	0.2	0.2	2.79	2.84
F 605	F 605 ZZ	—	6.6	6.9	0.2	0.2	3.9	3.85
F 625	F 625 ZZ1	VV DD	7.0	7.5	0.3	0.3	5.37	5.27
F 635	F 635 ZZ1	VV DD	7.0	8.5	0.3	0.3	9.49	9.49
MF 106	MF 106 ZZ1	—	7.2	7.0	0.15	0.1	0.65	0.77
MF 126	MF 126 ZZ	—	7.6	7.2	0.2	0.15	1.38	1.94
F 686 A	F 686 AZZ	VV DD	7.2	7.4	0.15	0.15	2.25	3.04
F 696	F 696 ZZ1	VV DD	7.6	7.9	0.2	0.2	4.34	4.26
F 606	F 606 ZZ	VV DD	8.0	8.2	0.3	0.3	6.58	6.61
F 626	F 626 ZZ1	VV DD	8.0	8.5	0.3	0.3	9.09	9.09
F 636	F 636 ZZ	VV DD	8.0	10.5	0.3	0.3	14.6	14.7
MF 117	MF 117 ZZ	—	8.2	8.0	0.15	0.1	0.72	0.82
MF 137	MF 137 ZZ	—	8.6	9.0	0.2	0.15	1.7	2.23
F 687	F 687 ZZ1	VV DD	8.2	8.5	0.15	0.15	2.48	3.37
F 697	F 697 ZZ1	VV DD	9.0	10.2	0.3	0.3	5.65	5.65
F 607	F 607 ZZ1	VV DD	9.0	9.1	0.3	0.3	8.66	8.66
F 627	F 627 ZZ	VV DD	9.0	10.5	0.3	0.3	14.2	14.2
MF 128	MF 128 ZZ1	—	9.2	9.0	0.15	0.1	0.82	1.15
MF 148	MF 148 ZZ	VV DD	9.6	9.2	0.2	0.15	2.09	2.39
F 688 A	F 688 AZZ	VV DD	9.6	10.2	0.2	0.2	3.54	4.47
F 698	F 698 ZZ	VV DD	10.0	10.0	0.3	0.3	8.35	8.3
F 608	F 608 ZZ	VV DD	10.0	10.5	0.3	0.3	13.4	13.5
F 689	F 689 ZZ1	VV DD	10.6	11.5	0.2	0.2	3.97	4.91
F 699	F 699 ZZ1	VV DD	11.0	12.0	0.3	0.3	9.51	9.51

Extra Small Ball Bearings · Miniature Ball Bearings

Inch Design

Bore Diameter 1.016 – 9.525 mm

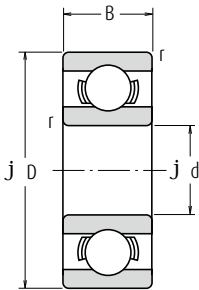

Open Type

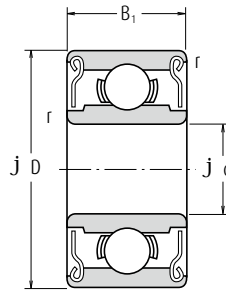

Shielded Type
ZZ · ZS

Boundary Dimensions (mm)					Basic Load Ratings (N)		Limiting Speeds (min ⁻¹)		Bearing
d	D	B	B ₁	r min.	C _r	C _{0r}	Grease	Oil	Open
							Open Z · ZZ	Open Z	
1.016	3.175	1.191	—	0.1	80	23	130 000	150 000	R 09
1.191	3.967	1.588	2.380	0.1	138	35	110 000	130 000	R 0
1.397	4.762	1.984	2.779	0.1	231	66	90 000	110 000	R 1
1.984	6.350	2.380	3.571	0.1	310	108	67 000	80 000	R 1-4
2.380	4.762	1.588	—	0.1	188	60	80 000	95 000	R 133
	4.762	—	2.380	0.1	143	52	80 000	95 000	—
3.175	7.938	2.779	3.571	0.15	550	175	60 000	71 000	R 1-5
	6.350	2.380	2.779	0.1	283	95	67 000	80 000	R 144
	7.938	2.779	3.571	0.1	560	179	60 000	67 000	R 2-5
	9.525	2.779	3.571	0.15	640	225	53 000	63 000	R 2-6
3.967	9.525	3.967	3.967	0.3	630	218	56 000	67 000	R 2
	12.700	4.366	4.366	0.3	640	225	53 000	63 000	R 2A
4.762	7.938	2.779	3.175	0.1	360	149	53 000	63 000	R 155
	7.938	2.779	3.175	0.1	360	149	53 000	63 000	R 156
6.350	9.525	3.175	3.175	0.1	710	270	50 000	60 000	R 166
	12.700	3.967	4.978	0.3	1 300	485	43 000	53 000	R 3
	9.525	3.175	3.175	0.1	420	204	48 000	56 000	R 168B
	12.700	3.175	4.762	0.15	1 080	440	40 000	50 000	R 188
7.938	15.875	4.978	4.978	0.3	1 610	660	38 000	45 000	R 4B
	19.050	5.558	7.142	0.4	2 620	1 060	36 000	43 000	R 4AA
9.525	12.700	3.967	3.967	0.15	540	276	40 000	48 000	R 1810
9.525	22.225	5.558	7.142	0.4	3 350	1 410	32 000	38 000	R 6

- Remarks**
1. When using bearings with a rotating outer ring, please contact NSK if they are shielded.
 2. Bearings with double shields (ZZ, ZS) are also available with single shields (Z, ZS).

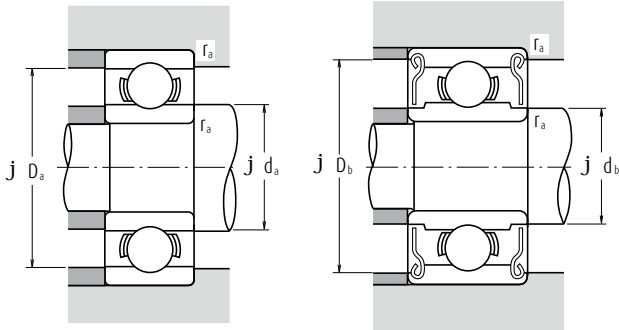

Radial and axial load factors

C_{0r}/F_a	$F_a/F_r \leq e$		$F_a/F_r > e$		e
	X	Y	X	Y	
5	1	0	0.56	1.26	0.35
10	1	0	0.56	1.49	0.29
15	1	0	0.56	1.64	0.27
20	1	0	0.56	1.76	0.25
25	1	0	0.56	1.85	0.24
30	1	0	0.56	1.92	0.23
50	1	0	0.56	2.13	0.20

Numbers	Abutment and Fillet Dimensions (mm)					Mass (g)	
	d_a min.	d_b max.	D_a max.	D_b min.	r_a max.	Open	Shielded
Shielded						approx.	
—	1.9	—	2.3	—	0.1	0.04	—
R 0 ZZ	2.0	1.9	3.1	3.5	0.1	0.09	0.11
R 1 ZZ	2.2	2.3	3.9	4.1	0.1	0.15	0.19
R 1-4 ZZ	2.8	3.9	5.5	5.9	0.1	0.35	0.50
—	3.2	—	3.9	—	0.1	0.10	—
R 133 ZZS	—	3.0	—	4.2	0.1	—	0.13
R 1-5 ZZ	3.6	4.1	6.7	7.0	0.15	0.60	0.72
R 144 ZZ	4.0	3.9	5.5	5.9	0.1	0.25	0.27
R 2-5 ZZ	4.0	4.3	7.1	7.3	0.1	0.55	0.72
R 2-6 ZZS	4.4	4.6	8.3	8.2	0.15	0.96	1.13
R 2 ZZ	5.2	4.8	7.5	8.0	0.3	1.36	1.39
R 2A ZZ	5.2	4.6	10.7	8.2	0.3	3.3	3.23
R 155 ZZS	4.8	5.5	7.1	7.3	0.1	0.51	0.56
R 156 ZZS	5.6	5.5	7.1	7.3	0.1	0.39	0.42
R 166 ZZ	5.6	5.9	8.7	8.8	0.1	0.81	0.85
R 3 ZZ	6.8	6.5	10.7	11.2	0.3	2.21	2.79
R 168 BZZ	7.2	7.0	8.7	8.9	0.1	0.58	0.62
R 188 ZZ	7.6	7.4	11.5	11.6	0.15	1.53	2.21
R 4B ZZ	8.4	8.4	13.8	13.8	0.3	4.5	4.43
R 4AA ZZ	9.4	9.0	16.0	16.6	0.4	7.48	9.17
R 1810 ZZ	9.2	9.0	11.5	11.6	0.15	1.56	1.48
R 6 ZZ	12.6	11.9	19.2	20.0	0.4	9.02	11

Extra Small Ball Bearings · Miniature Ball Bearings

Inch Design With Flange Bore Diameter 1.191 – 9.525 mm

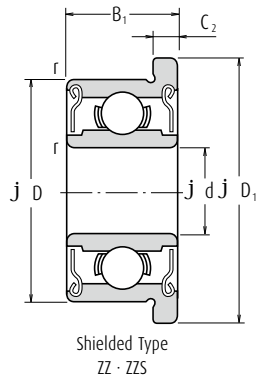
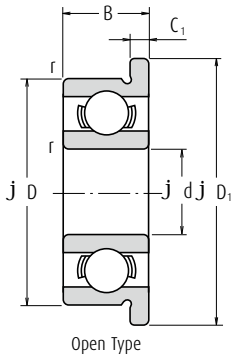

Boundary Dimensions (mm)								Basic Load Ratings (N)	
d	D	D ₁	B	B ₁	C ₁	C ₂	r min.	C _r	C _{0r}
1.191	3.967	5.156	1.588	2.380	0.330	0.790	0.1	138	35
1.397	4.762	5.944	1.984	2.779	0.580	0.790	0.1	231	66
1.984	6.350	7.518	2.380	3.571	0.580	0.790	0.1	310	108
2.380	4.762	5.944	1.588	—	0.460	—	0.1	188	60
	4.762	5.944	—	2.380	—	0.790	0.1	143	52
	7.938	9.119	2.779	3.571	0.580	0.790	0.15	550	175
3.175	6.350	7.518	2.380	2.779	0.580	0.790	0.1	283	95
	7.938	9.119	2.779	3.571	0.580	0.790	0.1	560	179
	9.525	10.719	2.779	3.571	0.580	0.790	0.15	640	225
3.967	9.525	11.176	3.967	3.967	0.760	0.760	0.3	630	218
	7.938	9.119	2.779	3.175	0.580	0.910	0.1	360	149
	4.762	7.938	9.119	2.779	3.175	0.580	0.910	0.1	360
4.762	9.525	10.719	3.175	3.175	0.580	0.790	0.1	710	270
	12.700	14.351	4.978	4.978	1.070	1.070	0.3	1 300	485
	9.525	10.719	3.175	3.175	0.580	0.910	0.1	420	204
6.350	12.700	13.894	3.175	4.762	0.580	1.140	0.15	1 080	440
	15.875	17.526	4.978	4.978	1.070	1.070	0.3	1 610	660
7.938	12.700	13.894	3.967	3.967	0.790	0.790	0.15	540	276
9.525	22.225	24.613	7.142	7.142	1.570	1.570	0.4	3 350	1 410

- Remarks**
1. When using bearings with a rotating outer ring, please contact NSK if they are shielded.
 2. Bearings with double shields (ZZ, ZS) are also available with single shields (Z, ZS).

Radial and axial load factors

C_{0r}/F_a	$F_a/F_r \leq e$		$F_a/F_r > e$		e
	X	Y	X	Y	
5	1	0	0.56	1.26	0.35
10	1	0	0.56	1.49	0.29
15	1	0	0.56	1.64	0.27
20	1	0	0.56	1.76	0.25
25	1	0	0.56	1.85	0.24
30	1	0	0.56	1.92	0.23
50	1	0	0.56	2.13	0.20

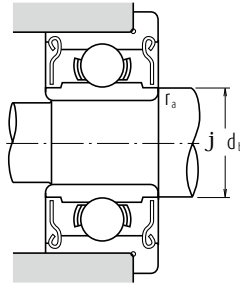
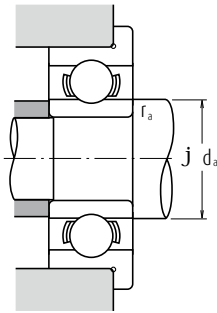

Limiting Speeds (min ⁻¹)		Bearing Numbers		Abutment and Fillet Dimensions (mm)			Mass (g)	
Grease	Oil	Open	Shielded	d_a min.	d_b max.	r_a max.	approx.	
Open Z [•] ZZ	Open Z						Open	Shielded
110 000	130 000	FR 0	FR 0 ZZ	2.0	1.9	0.1	0.11	0.16
90 000	110 000	FR 1	FR 1 ZZ	2.2	2.3	0.1	0.20	0.25
67 000	80 000	FR 1-4	FR 1-4 ZZ	2.8	3.9	0.1	0.41	0.58
80 000	95 000	FR 133	—	3.2	—	0.1	0.13	—
80 000	95 000	—	FR 133 ZZS	—	3.0	0.1	—	0.19
60 000	71 000	FR 1-5	FR 1-5 ZZ	3.6	4.1	0.15	0.68	0.82
67 000	80 000	FR 144	FR 144 ZZ	4.0	3.9	0.1	0.31	0.35
60 000	67 000	FR 2-5	FR 2-5 ZZ	4.0	4.3	0.1	0.62	0.81
53 000	63 000	FR 2-6	FR 2-6 ZZS	4.4	4.6	0.15	1.04	1.25
56 000	67 000	FR 2	FR 2 ZZ	5.2	4.8	0.3	1.51	1.55
53 000	63 000	FR 155	FR 155 ZZS	4.8	5.5	0.1	0.59	0.67
53 000	63 000	FR 156	FR 156 ZZS	5.6	5.5	0.1	0.47	0.53
50 000	60 000	FR 166	FR 166 ZZ	5.6	5.9	0.1	0.90	0.98
43 000	53 000	FR 3	FR 3 ZZ	6.8	6.5	0.3	2.97	3.09
48 000	56 000	FR 168B	FR 168 BZZ	7.2	7.0	0.1	0.66	0.75
40 000	50 000	FR 188	FR 188 ZZ	7.6	7.4	0.15	1.64	2.49
38 000	45 000	FR 4B	FR 4B ZZ	8.4	8.4	0.3	4.78	4.78
40 000	48 000	FR 1810	FR 1810 ZZ	9.2	9.0	0.15	1.71	1.63
32 000	38 000	FR 6	FR 6 ZZ	12.6	11.9	0.4	10.1	12.1

Angular Contact Ball Bearings



3. ANGULAR CONTACT BALL BEARINGS

INTRODUCTION	Page B 074
--------------------	---------------

TECHNICAL DATA

Free Space of Angular Contact Ball Bearings.....	Page B 080
Dynamic Equivalent Load of Triplex Angular Contact Ball Bearings.....	B 082
Angular Clearances in Double-Row Angular Contact Ball Bearings.....	B 084
Relationship between Radial and Axial Clearances in Double-Row Angular Contact Ball Bearings.....	B 086



BEARINGS TABLE

SINGLE-ROW AND MATCHED ANGULAR CONTACT BALL BEARINGS

Bore Dia.	Page
10 - 200 mm	B 088

DOUBLE-ROW ANGULAR CONTACT BALL BEARINGS

Bore Dia.	Page
10 - 85 mm	B 108

PULLEYS

Bore Dia.	Page
10 - 35 mm	B 112

FOUR-POINT CONTACT BALL BEARINGS

Bore Dia.	Page
30 - 200 mm	B 114

Angular Contact Ball Bearings

DESIGN, TYPES, AND FEATURES

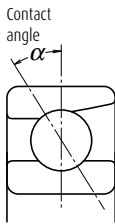

SINGLE-ROW ANGULAR CONTACT BALL BEARINGS

Since these bearings have a contact angle, they can sustain significant axial loads in one direction together with radial loads. Because of their design, when a radial load is applied, an axial force component is produced; therefore, two opposed bearings or a combination of more than two must be used.

Since the rigidity of single-row angular contact ball bearings can be increased by preloading, they are often used in the main spindles of machine tools, for which high running accuracy is required. (Refer to Chapter 9, Preload, Page A192)

Usually, the cages for angular contact ball bearings with a contact angle of 30° (Symbol **A**) or 40° (Symbol **B**) are in accordance with Table 1, but depending on the application, machined synthetic resin cages or molded polyamide resin cages are also used. The basic load ratings given in the bearing tables are based on the cage classification listed in Table 1.

Though the figures in the bearing tables (Pages B086 to B101; bearing bore diameters of 10 to 120) show bearings with single-shoulder-type inner rings, both-shoulder-type bearings are also available. Please consult NSK for more detailed information.

Double Row Angular Contact Ball Bearings (BTNG Design) & Pulleys Lubrication

NSK supplies pulleys filled with grease at the factory. This is a high-quality lithiumbased grease with an admissible temperature range of -30 °C to +110 °C. The grease used by NSK is compatible with all other mineraloil- based greases. The inner rings of the pulleys are provided with a lubrication hole so that bearings can be re-lubricated. With Version 2RSR, the grease must be pressed in slowly to avoid damaging the seals.

Pulleys Bearing load capacity

If the pulley is supported by a flat contact surface, only a small surface area of the outer ring of the pulleys comes into contact with the rolling plane. The elastic deformation of the outer ring reduces the load-bearing capacity of the pulley. In this case, the values specified in the "Pulley load ratings" table must be used in the calculation. On the other hand, when installing the pulley in a housing bore, the "Bearing load ratings" apply which are also listed.

Table 1 Features of Single-Row Angular Contact Ball Bearings

Cage	Material	Steel	Nylon 46		L-PPS resin	Brass	
		Method	Molded		Molded	machined	
		Symbols	W	TYN	T85	T7	Omitted
Features	High Load Capacity	F	a	F	F	a	F
	High-Speed	b	F	a	a	b	a
	High-Temperature	F	b	b	F	F	F
	Vibration	b	b	b	b	F	F

In addition, for bearings with the same serial number, if the type of cages are different, the number of balls may also be different. In such a case, the load rating will differ from the one listed in the bearing tables.

Angular Contact Ball Bearings with contact angles of 15° (Symbol **C**) and 25° (Symbol **A5**) are primarily for high precision or high speed applications, and molded polyamide cages (Symbol TYN) or machined brass cages or synthetic resin cages (Symbol T) are used.

The maximum operating temperature of molded polyamide cages is 150°C.

MATCHED ANGULAR CONTACT BALL BEARINGS

The types and features of matched angular contact ball bearings are shown in Table 2.

Table 2 Types and Features of Matched Angular Contact Ball Bearings

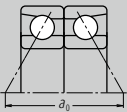
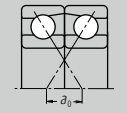
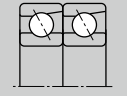
Figure	Arrangement	Features
	Back-to-back (DB) (Example) 7208 A DB	Radial loads and axial loads in both directions can be sustained. Since the distance between the effective load centers a_0 is big, this type is suitable if moments are applied.
	Face-to-face (DF) (Example) 7208 B DF	Radial loads and axial loads in both directions can be sustained. Compared with the DB Type, the distance between the effective load centers is small, so the capacity to sustain moments is inferior to the DB Type.
	Tandem (DT) (Example) 7208 A DT	Radial loads and axial loads in one direction can be sustained. Since two bearings share the axial load, this arrangement is used when the load in one direction is heavy.

NSKHPS™ ANGULAR CONTACT BALL BEARINGS

In comparison with standard angular contact ball bearings, these bearings have high capacity, high limiting speed, and highly accurate universal matching as the features. The molded polyamide cages are standard specification for the HPS type.

Angular Contact Ball Bearings

c Formulation of Bearing Numbers

Single-Row Angular Contact Ball Bearings Matched Angular Contact Ball Bearings

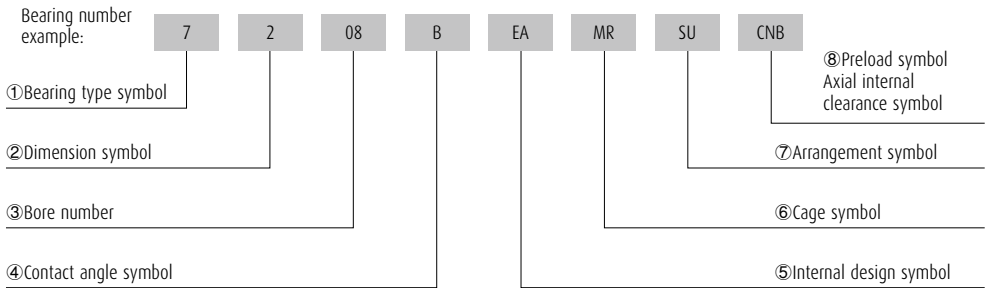

- ① Bearing type symbol 7 : Single-Row Angular Contact Ball Bearings, Matched Angular Contact Ball Bearings
- ② Dimension symbol 2 : 02 Series, 3 : 03 Series, 9 : 19 Series, 0 : 10 Series
- ③ Bore number Less than 03, Bearing bore 00 : 10mm, 01 : 12mm, 02 : 15mm, 03 : 17mm
Over 04, Bearing bore Bore number $\times 5$ (mm)
- ④ Contact angle symbol C : 15°, A5 : 25°, A : 30°, B : 40°
- ⑤ Internal design symbol EA : High Load Capacity
- ⑥ Cage symbol W : Pressed Steel Cage, MR : Machined Brass Cage (Ball guided),
No symbol : Machined Brass Cage (Outer Ring guided), TYN : Polyamide Resin Cage,
T85 : Polyamide 46 Resin Cage, T7 : L-PPS Resin Cage
- ⑦ Arrangement symbol SU : Universal arrangement (Single row), DU : Universal arrangement (Double row),
DB : Back-to-back arrangement, DF : Face-to-face arrangement, DT : Tandem arrangement
- ⑧ Preload symbol Axial internal clearance symbol EL : Extra light preload, L : Light preload, M : Medium preload, H : Heavy preload
Omitted : CN clearance, C3 : Clearance greater than CN, C4 : Clearance greater than C3,
CNB : CN Clearance equivalent (Universal arrangement)

DOUBLE-ROW ANGULAR CONTACT BALL BEARINGS

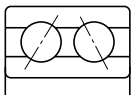

This is basically a back-to-back mounting of two single-row angular contact ball bearings, but their inner and outer rings are each integrated into one. Axial loads in both directions can be sustained, and the capacity to sustain moments is good. This type is used as fixed-end bearings.

Their cages are pressed steel.

c Formulation of Bearing Numbers

Double-Row Angular Contact Ball Bearings

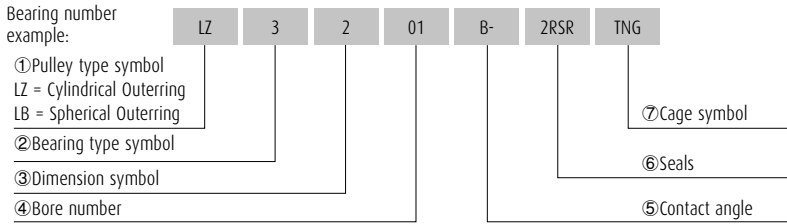

- ① Pulley type symbol
- ② Bearing type symbol 5 : Double-Row Angular Contact Ball Bearings
- ③ Dimension symbol 2 : 02 Series
- ④ Bore number Less than 03, Bearing bore 00 : 10mm, 01 : 12mm, 02 : 15mm, 03 : 17mm
Over 04, Bearing bore Bore number $\times 5$ (mm)
- ⑤ Contact angle B = 25°
- ⑥ Seals 2RSR = Seals; 2ZR = Shields
- ⑦ Cage symbol TNG Polyamid Cage Nylon 66

FOUR-POINT CONTACT BALL BEARINGS

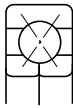

The inner ring is split radially into two pieces. Their design allows one bearing to sustain significant axial loads in either direction.

The contact angle is 35°, so the axial load capacity is high. This type is suitable for carrying pure axial loads or combined loads where the axial loads are high.

The cages are made of machined brass.

c Formulation of Bearing Numbers

Four-Point Contact Ball Bearings

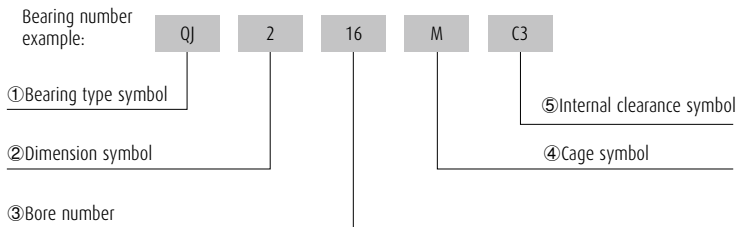

- ① Bearing type symbol QJ : Four-Point Contact Ball Bearings
- ② Dimension symbol 10 : 10 Series, 2 : 02 Series, 3 : 03 Series
- ③ Bore number Less than 03, Bearing bore 00 : 10mm, 01 : 12mm, 02 : 15mm, 03 : 17mm
Over 04, Bearing bore Bore number $\times 5$ (mm)
- ④ Cage symbol M : Machined Brass Cage
- ⑤ Internal clearance symbol C2 : Clearance less than CN, Omitted : CN clearance,
C3 : Clearance greater than CN, C4 : Clearance greater than C3

Angular Contact Ball Bearings

PRECAUTIONS FOR USE OF ANGULAR CONTACT BALL BEARINGS

Under severe operating conditions where the speed and temperature are close to their limits, lubrication is marginal, vibration and moment loads are heavy, they may not be suitable, particularly for certain types of cages. In such a case, please consult with NSK beforehand.

And if the load on angular contact ball bearings becomes too small, or if the ratio of the axial and radial loads for matched bearings exceeds 'e' (e is listed in the bearings tables) during operation, slippage occurs between the balls and raceways, which may result in smearing. Especially with large bearings since the weight of the balls and cage is high. If such load conditions are expected, please consult with NSK for selection of the bearings.

TOLERANCES AND RUNNING ACCURACY

	Tables	Pages
Single-Row Angular Contact Ball Bearings	7.2	A128 to A131
NSKHPS Angular Contact Ball Bearings		
Tolerance for Dimensions: Class 6, Running Accuracy: Class 5	7.2	A128 to A131
Matched Angular Contact Ball Bearings	7.2	A128 to A131
Double-Row Angular Contact Ball Bearings	7.2	A128 to A131
Four-Point Contact Ball Bearings	7.2	A128 to A131

RECOMMENDED FITS

	Tables	Page
Single-Row Angular Contact Ball Bearings	8.3	A164
and HPS Angular Contact Ball Bearings	8.5	A165
Matched Angular Contact Ball Bearings	8.3	A164
	8.5	A165
Double-Row Angular Contact Ball Bearings	8.3	A164
	8.5	A165
Four-Point Contact Ball Bearings	8.3	A164
	8.5	A165

INTERNAL CLEARANCE

Matched Angular Contact Ball Bearings

Table	Page
8.18	A174

Matched angular contact ball bearings with precision better than P5 are primarily used in the main spindles of machine tools, so they are used with a preload for rigidity. For convenience of selection, internal clearance are adjusted to produce Very Light, Light, Medium, and Heavy Preloads. Their fitting is also special. Concerning these matters, please refer to Tables 9.1 and 9.5 (Pages A194 and A197).

The clearance (or preload) of matched bearings is obtained by axially tightening a pair of bearings till the side faces of their inner or outer rings are pressed against each other.



NSKHPS Angular Contact Ball Bearings

Axial Internal Clearance (Measured Clearance) Units : μm

Nominal Bore Diameter d (mm)		Axial Internal Clearance			
		CNB		GA	
over	incl.	min.	max.	min.	max.
12	18	17	25		
18	30	20	28	-2	6
30	50	24	32		
50	80	29	41	-3	9

Double-Row Angular Contact Ball Bearings

For the clearance in double-row angular contact ball bearings, please consult with NSK.

Four-Point Contact Ball Bearings

Table	Page
8.19	A174

LIMITING SPEEDS (Grease/Oil)

In cases of single-row and matched angular contact ball bearings, The limiting speeds (grease) and limiting speeds (oil) listed in the bearing table are for bearings with standard cage. For those with option cages, limiting speeds (grease/oil) may differ depending on cages. Please consult with NSK. For example, limiting speeds (grease/oil) of machined cage (No symbol) is 1.25 times higher than pressed cage. The limiting speeds of bearings with contact angles of 15° (Symbol C) and 25° (Symbol A5) are for bearings with precision of P5 and better (with machined synthetic-resin cages (T) or molded polyamide cages (TYN)). The limiting speeds listed in the bearing tables should be adjusted depending on the bearing load conditions. Also, higher speeds are attainable by making changes in the lubrication method, cage design, etc. Refer to Page A098 for detailed information.

Angular Contact Ball Bearings

TECHNICAL DATA

Free Space of Angular Contact Ball Bearings

Angular contact ball bearings are used in various components, such as spindles of machine tools, vertical pump motors, and worm gear reducers. This kind of bearing is used mostly with grease lubrication. But such grease lubrication may affect the bearing in terms of temperature rise or durability. To allow a bearing to demonstrate its full performance, it is essential to fill the bearing with the proper amount of a suitable grease. A prerequisite for this job is a knowledge of the bearing's free space.

The angular ball bearing is available in various kinds which are independent of the combinations of bearing series, contact angle, and cage type. The free space of the bearings used most frequently is described below. Table 1 shows the free space of a bearing with a pressed cage for general use and Table 2 shows that of a bearing with a high-tension brass machined cage.

The contact angle symbols A, B, and C in each table refer to the nominal contact angles of 30°, 40°, and 15° of each bearing.

**Table 1 Free Space of Angular Contact Ball Bearing (1)
(With Pressed Steel Cage)**

Units: cm³

Bearing bore No.	Bearing free space			
	Bearing series - Contact angle symbol			
	72-A	72-B	73-A	73-B
00	1.5	1.4	2.9	2.8
01	2.1	2.0	3.7	3.5
02	2.8	2.7	4.8	4.6
03	3.7	3.6	6.2	5.9
04	6.2	5.9	8.4	8.0
05	7.8	7.4	13	12
06	12	11	20	19
07	16	15	26	24
08	20	19	36	34
09	25	24	48	45
10	28	27	63	60

**Table 2 Free Space of Angular Contact Ball Bearing (2)
(With High-Tension Brass Machined Cage)**

Units: cm³

Bearing bore No.	Bearing free space				
	Bearing series - Contact angle symbol				
	70-C	72-A 72-C	72-B	73-A 73-C	73-B
00	0.9	1.0	1.0	2.2	2.1
01	0.9	1.6	1.6	2.5	2.5
02	1.2	1.9	1.9	3.4	3.3
03	1.6	2.7	2.7	4.6	4.4
04	3.0	4.7	4.2	6.1	5.9
05	3.5	6.0	5.3	9.2	9.0
06	4.3	8.5	8.1	14	13
07	6.5	12	11	18	17
08	8.3	14	14	25	24
09	10	18	17	34	33
10	11	20	20	45	44
11	16	26	25	57	55
12	17	33	31	71	69
13	18	38	37	87	83
14	24	43	42	107	103
15	24	47	45	129	123
16	34	58	57	152	146
17	37	71	70	179	172
18	44	88	85	207	201
19	44	105	105	261	244
20	47	127	127	282	278



Angular Contact Ball Bearings

Dynamic Equivalent Load of Triplex Angular Contact Ball Bearings

Three separate single-row bearings may be used side by side as shown in the figure when angular contact ball bearings are to be used to carry a large axial load. There are three patterns of combination, which are expressed by combination symbols of DBD, DFD, and DTD.

As in the case of single-row and double-row bearings, the dynamic equivalent load, which is determined from the radial and axial loads acting on a bearing, is used to calculate the fatigue life for these combined bearings.

Assuming the dynamic equivalent radial load as P_r , the radial load as F_r , and axial load as F_a , the relationship between the dynamic equivalent radial load and bearing load may be approximated as follows:

$$P_r = XF_r + YF_a \quad \text{..... (1)}$$

where, X : Radial load factor } See Table 1
 Y : Axial load factor }

The axial load factor varies with the contact angle. In an angular contact ball bearing, whose contact angle is small, the contact angle varies substantially when the axial load increases.

A change in the contact angle can be expressed by the ratio between the basic static load rating C_{0r} and axial load F_a . Accordingly, for the angular contact ball bearing with a contact angle of 15° , the axial load factor at a contact angle corresponding to this ratio is shown. If the angular contact ball bearings have contact angles of 25° , 30° and 40° , the effect of change in the contact angle on the axial load factor may be ignored and thus the axial load factor is assumed as constant.

Arrangement	Load direction
3 row matched stack, axial load is supported by 2 rows. (Symbol DBD or DFD)	
3 row matched stack, axial load is supported by 1 row. (Symbol DBD or DFD)	
3 row tandem matched stack (Symbol DTD)	

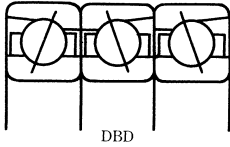

DBD

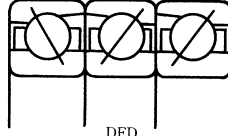

DFD

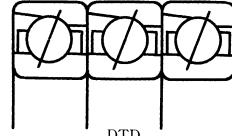

DTD

Table 1 Factors X and Y of Triplex Angular Contact Ball Bearing

Contact angle α	j	$\frac{C_{0r}}{jF_a}$	$\frac{F_a}{F_r} \leq e$		$\frac{F_a}{F} > e$		e	Basic load rating of 3 row ball bearings	
			X	Y	X	Y		C_r	C_{0r}
15°	1.5	5	1	0.64	0.58	1.46	0.51	2.16 times of single bearing	3 times of single bearing
15°	1.5	10	1	0.70	0.58	1.61	0.47		
15°	1.5	15	1	0.74	0.58	1.70	0.44		
15°	1.5	20	1	0.76	0.58	1.75	0.42		
15°	1.5	25	1	0.78	0.58	1.81	0.41		
15°	1.5	30	1	0.80	0.58	1.83	0.40		
15°	1.5	50	1	0.83	0.58	1.91	0.39		
25°	—	—	1	0.48	0.54	1.16	0.68		
30°	—	—	1	0.41	0.52	1.01	0.80		
40°	—	—	1	0.29	0.46	0.76	1.14		
15°	3	5	1	2.28	0.95	2.37	0.51	2.16 times of single bearing	3 times of single bearing
15°	3	10	1	2.51	0.95	2.61	0.47		
15°	3	15	1	2.64	0.95	2.76	0.44		
15°	3	20	1	2.73	0.95	2.85	0.42		
15°	3	25	1	2.80	0.95	2.93	0.41		
15°	3	30	1	2.85	0.95	2.98	0.40		
15°	3	50	1	2.98	0.95	3.11	0.39		
25°	—	—	1	1.70	0.88	1.88	0.68		
30°	—	—	1	1.45	0.84	1.64	0.80		
40°	—	—	1	1.02	0.76	1.23	1.14		
15°	1	5	1	0	0.44	1.10	0.51	2.16 times of single bearing	3 times of single bearing
15°	1	10	1	0	0.44	1.21	0.47		
15°	1	15	1	0	0.44	1.28	0.44		
15°	1	20	1	0	0.44	1.32	0.42		
15°	1	25	1	0	0.44	1.36	0.41		
15°	1	30	1	0	0.44	1.38	0.40		
15°	1	50	1	0	0.44	1.44	0.39		
25°	—	—	1	0	0.41	0.87	0.68		
30°	—	—	1	0	0.39	0.76	0.80		
40°	—	—	1	0	0.35	0.57	1.14		

Angular Contact Ball Bearings

Angular Clearances in Double-Row Angular Contact Ball Bearings

The angular clearance in double-row bearings is defined in exactly the same way as for single-row bearings; i.e., with one of the bearing rings fixed, the angular clearance is the greatest possible angular displacement of the axis of the other ring.

Since the angular clearance is the greatest total relative displacement of the two ring axes, it is twice the possible angle of inner and outer ring movement (the maximum angular displacement in one direction from the center without creating a moment).

The relationship between axial and angular clearance for double-row angular contact ball bearings is given by Equation (1) below.

$$\Delta_a = 2m_0 \left\{ \sin a_0 + \frac{\theta R_i}{2m_0} \sqrt{1 - \left(\cos a_0 + \frac{\theta l}{4m_0} \right)^2} \right\} \quad (1)$$

where,

Δ_a : Axial clearance (mm)

m_0 : Distance between inner and outer ring groove curvature centers, $m_0 = r_e + r_i - D_w$ (mm)

r_e : Outer-ring groove radius (mm)

r_i : Inner-ring groove radius (mm)

a_0 : Initial contact angle (°)

θ : Angular clearance (rad)

R_i : Distance between shaft center and inner-ring groove curvature center (mm)

l : Distance between left and right groove centers of inner-ring (mm)

The relationship between radial clearance Δ_r and axial clearance Δ_a for double-row angular contact ball bearings was explained in pages B086 and B087. Based on those equations, Fig. 2 shows the relationship between angular clearance θ and radial clearance Δ_r .

The above equation is shown plotted in Fig. 1 for NSK double-row angular contact ball bearings series 52, 53, 32, and 33.

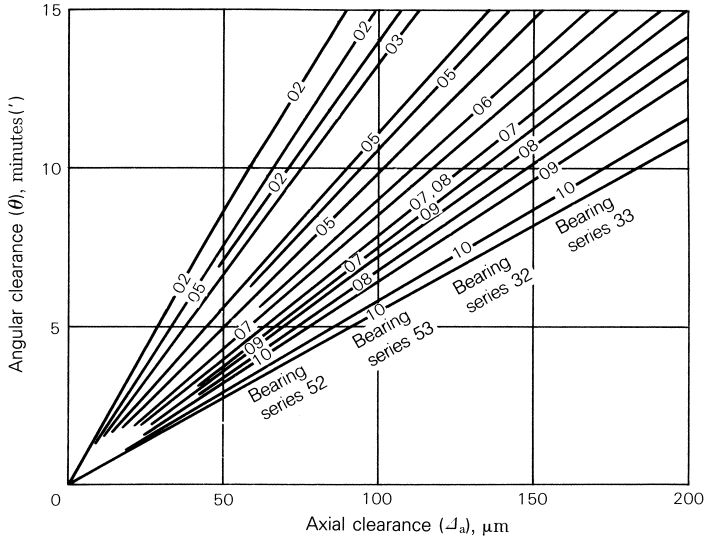

Fig. 1 Relationship between Axial and Angular Clearances

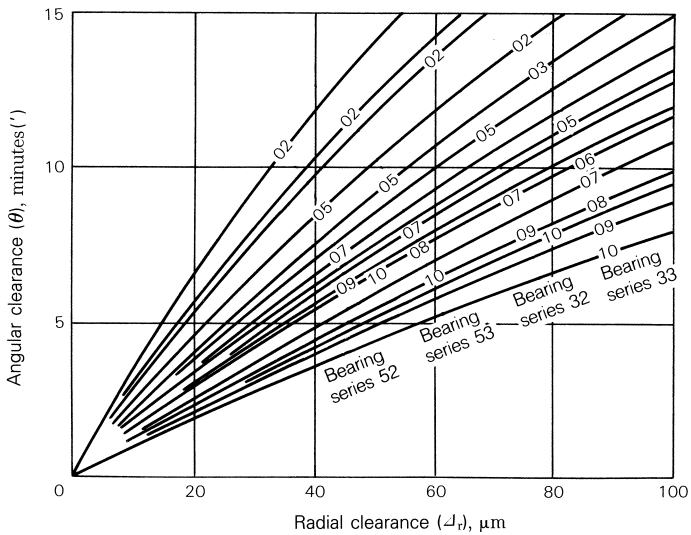

Fig. 2 Relationship between Radial and Angular Clearances

Angular Contact Ball Bearings

Relationship between Radial and Axial Clearances in Double-Row Angular Contact Ball Bearings

The relationship between the radial and axial internal clearances in double-row angular contact ball bearings can be determined geometrically as shown in Fig. 1 below.

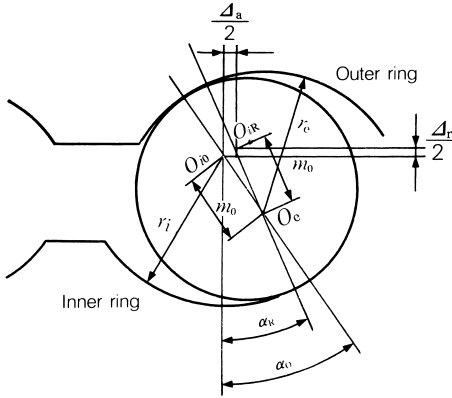

Fig. 1

- where, Δ_r : Radial clearance (mm)
 Δ_a : Axial clearance (mm)
 α_0 : Initial contact angle, inner or outer ring displaced axially
 α_R : Initial contact angle, inner or outer ring displaced radially
 O_e : Center of outer-ring groove curvature (outer ring fixed)
 O_{i0} : Center of inner-ring groove curvature (inner ring displaced axially)
 O_{iR} : Center of inner-ring groove curvature (inner ring displaced radially)
 m_0 : Distance between inner and outer ring groove-curvature centers,
 $m_0 = r_i + r_e - D_w$
 D_w : Ball diameter (mm)
 r_i : Radius of inner-ring groove (mm)
 r_e : Radius of outer-ring groove (mm)

The following relations can be derived from Fig. 1:

$$m_0 \sin \alpha_0 = m_0 \sin \alpha_R + \frac{\Delta_a}{2} \dots \dots \dots (1)$$

$$m_0 \cos \alpha_0 = m_0 \cos \alpha_R + \frac{\Delta_r}{2} \dots \dots \dots (2)$$

$$\text{since } \sin^2 \alpha_0 = 1 - \cos^2 \alpha_0, \\ (m_0 \sin \alpha_0)^2 = m_0^2 - (m_0 \cos \alpha_0)^2 \dots \dots \dots (3)$$

Combined Equations (1), (2), and (3), we obtain:

$$\left(m_0 \sin \alpha_R + \frac{\Delta_a}{2} \right)^2 = m_0^2 - \left(m_0 \cos \alpha_R - \frac{\Delta_r}{2} \right)^2 \dots \dots \dots (4)$$

$$\Delta_a = 2 \sqrt{m_0^2 - \left(m_0 \cos \alpha_R - \frac{\Delta_r}{2} \right)^2} - 2 m_0 \sin \alpha_R \dots \dots \dots (5)$$

α_R is 25° for 52 and 53 series bearings and 32° for 32 and 33 series bearings. If we set α_R equal to 0° , Equation (5) becomes:

$$\Delta_a = 2 \sqrt{m_0^2 - \left(m_0 - \frac{\Delta_r}{2} \right)^2} \\ = 2 \sqrt{m_0 \Delta_r - \frac{\Delta_r^2}{4}}$$

However, $\frac{\Delta_r^2}{4}$ is negligible.

$$\Delta_a \approx H 2 m_0^{1/2} \Delta_r^{1/2} \dots \dots \dots (6)$$

This is identical to the relationship between the radial and axial clearances in single-row deep groove ball bearings. The value of m_0 is dependent on the inner and outer ring groove radii. The relation between Δ_r and Δ_a , as given by Equation (5), is shown in Figs. 2 and 3 for NSK 52, 53, 32, and 33 series double-row angular contact ball bearings. When the clearance range is small, the axial clearance is given approximately by

$$\Delta_a \approx H \Delta_r \cot \alpha_R \dots \dots \dots (7)$$

However, when the clearance is relatively large, (when $\Delta_r/D_w > 0.002$) the error in Equation (7) can be quite large. The contact angle α_r is independent of the radial clearance; however, the initial contact angle α_0 varies with the radial clearance when the inner or outer ring is displaced axially. This relationship is given by Equation (2).

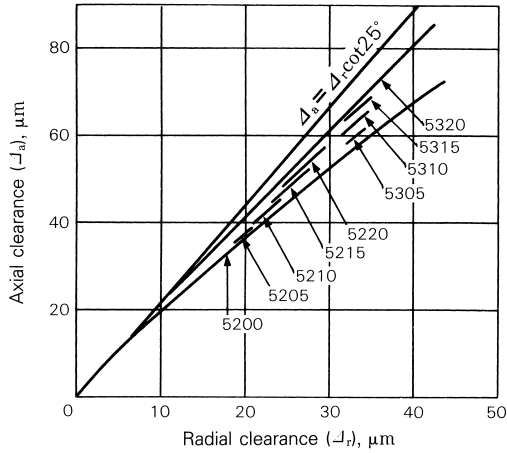

Fig. 2 Radial and Axial Clearances of Bearing Series 52 and 53

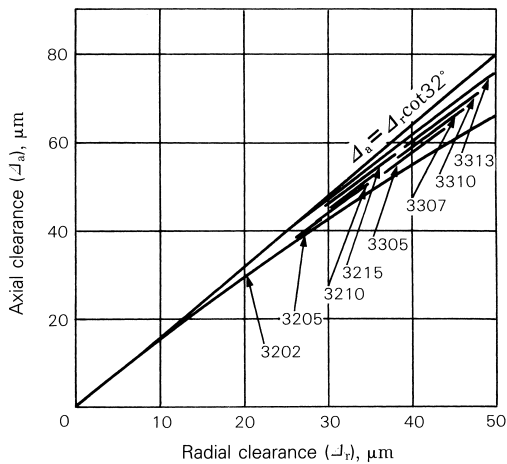
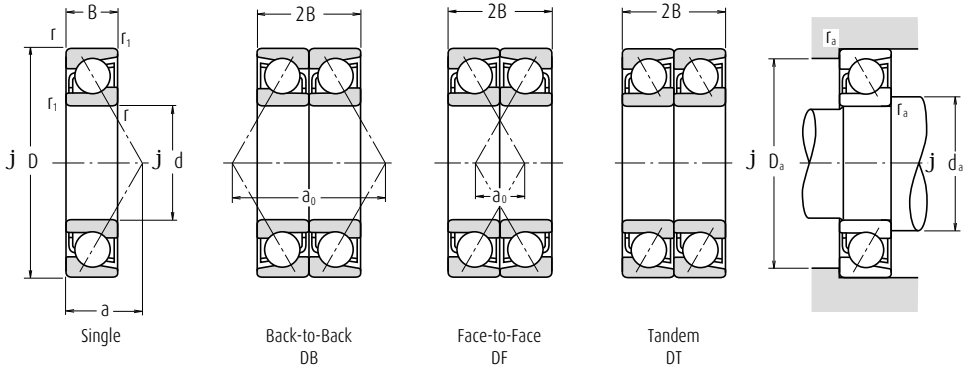

Fig. 3 Radial and Axial Clearances of Bearing Series 32 and 33

Angular Contact Ball Bearings

Single/matched mountings Bore Diameter 10 – 15 mm



Boundary Dimensions (mm)					Basic Load Ratings (Single) (N)		Factor	Limiting Speeds (1) (min ⁻¹)		Eff. Load Centers (mm)	Abutment and Fillet Dimensions (mm)			Mass (kg)
d	D	B	r min.	r ₁ min.	C _r	C _{0r}	f ₀	Grease	Oil	a	d _a min.	D _a max.	r _a max.	approx.
10	22	6	0.3	0.15	3 000	1 450	—	62 500	93 800	6.7	12.5	19.5	0.3	0.009
	22	6	0.3	0.15	3 150	1 520	14.1	71 900	109 000	5.1	12.5	19.5	0.3	0.009
	26	8	0.3	0.15	5 250	2 340	—	41 700	55 600	9.2	12.5	23.5	0.3	0.019
	26	8	0.3	0.15	5 600	2 490	12.6	63 900	97 300	6.4	12.5	23.5	0.3	0.021
	30	9	0.6	0.3	5 300	2 440	—	37 500	50 000	10.3	15	25	0.6	0.032
	30	9	0.6	0.3	5 000	2 500	—	20 000	28 000	12.9	15	25	0.6	0.032
	30	9	0.6	0.3	5 650	2 610	13.2	57 500	87 500	7.2	15	25	0.6	0.036
	35	11	0.6	0.3	9 300	4 300	—	20 000	26 000	12.0	15	30	0.6	0.053
	35	11	0.6	0.3	8 750	4 050	—	18 000	24 000	14.9	15	30	0.6	0.054
	12	24	6	0.3	0.15	3 350	1 770	—	55 600	83 400	7.2	14.5	21.5	0.3
24		6	0.3	0.15	3 550	1 860	14.7	63 900	97 300	5.4	14.5	21.5	0.3	0.011
28		8	0.3	0.15	5 700	2 710	—	37 500	50 000	9.8	14.5	25.5	0.3	0.021
28		8	0.3	0.15	6 100	2 900	13.2	57 500	87 500	6.7	14.5	25.5	0.3	0.024
32		10	0.6	0.3	7 850	3 650	—	34 100	45 500	11.4	17	27	0.6	0.037
32		10	0.6	0.3	7 450	3 750	—	18 000	26 000	14.2	17	27	0.6	0.038
32		10	0.6	0.3	8 150	3 750	—	20 000	30 000	14.2	17	27	0.6	0.036
32		10	0.6	0.3	8 300	3 850	12.5	52 300	79 600	7.9	17	27	0.6	0.041
37		12	1	0.6	9 450	4 500	—	18 000	24 000	13.1	18	31	1	0.060
37		12	1	0.6	8 850	4 200	—	16 000	22 000	16.3	18	31	1	0.062
37	12	1	0.6	11 100	4 950	—	18 000	26 000	16.3	18	31	1	0.061	
15	28	7	0.3	0.15	4 750	2 530	—	46 600	69 800	8.5	17.5	25.5	0.3	0.015
	28	7	0.3	0.15	5 000	2 640	14.5	53 500	81 400	6.4	17.5	25.5	0.3	0.015
	32	9	0.3	0.15	6 050	3 150	—	32 000	42 600	11.3	17.5	29.5	0.3	0.030
	32	9	0.3	0.15	6 550	3 400	14.1	49 000	74 500	7.6	17.5	29.5	0.3	0.034
	35	11	0.6	0.3	8 500	4 250	—	30 000	40 000	12.7	20	30	0.6	0.045
	35	11	0.6	0.3	7 950	4 300	—	16 000	22 000	16.0	20	30	0.6	0.046
	35	11	0.6	0.3	9 800	4 800	—	18 000	26 000	16.0	20	30	0.6	0.044
	35	11	0.6	0.3	9 100	4 550	13.2	46 000	70 000	8.8	20	30	0.6	0.052
	42	13	1	0.6	13 400	7 100	—	16 000	22 000	14.7	21	36	1	0.084
	42	13	1	0.6	12 500	6 600	—	14 000	19 000	18.5	21	36	1	0.086
42	13	1	0.6	14 300	6 900	—	16 000	22 000	18.5	21	36	1	0.084	

- Notes**
- (1) For applications operating near the limiting speed, refer to Page B079.
 - (2) The suffixes A, A5, B, and C represent contact angles of 30°, 25°, 40°, and 15° respectively.
 - (3) For bearings marked — in the column for d_b , d_b and r_b for shafts are d_a (min.) and r_a (max.) respectively.

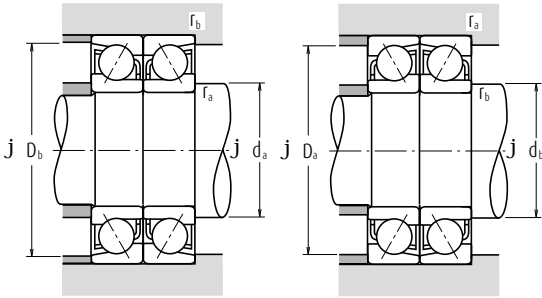

Dynamic Equivalent Load $P = X F_r + Y F_a$

Contact Angle	$\frac{i f_0 F_a^*}{C_{0r}}$	e	Single, DT				DB or DF			
			$F_a/F_r \leq e$		$F_a/F_r > e$		$F_a/F_r \leq e$		$F_a/F_r > e$	
			X	Y	X	Y	X	Y	X	Y
15°	0.178	0.38	1	0	0.44	1.47	1	1.65	0.72	2.39
	0.357	0.40	1	0	0.44	1.40	1	1.57	0.72	2.28
	0.714	0.43	1	0	0.44	1.30	1	1.46	0.72	2.11
	1.07	0.46	1	0	0.44	1.23	1	1.38	0.72	2.00
	1.43	0.47	1	0	0.44	1.19	1	1.34	0.72	1.93
	2.14	0.50	1	0	0.44	1.12	1	1.26	0.72	1.82
	3.57	0.55	1	0	0.44	1.02	1	1.14	0.72	1.66
	5.35	0.56	1	0	0.44	1.00	1	1.12	0.72	1.63
25°	—	0.68	1	0	0.41	0.87	1	0.92	0.67	1.41
30°	—	0.80	1	0	0.39	0.76	1	0.78	0.63	1.24
40°	—	1.14	1	0	0.35	0.57	1	0.55	0.57	0.93

*For i, use 2 for DB, DF and 1 for DT

Static Equivalent Load $P_0 = X_0 F_r + Y_0 F_a$

Contact Angle	Single, DT		DB or DF		Single or DT mounting When $F_r > 0.5 F_r + Y_0 F_a$ use $P_0 = F_r$
	X_0	Y_0	X_0	Y_0	
15°	0.5	0.46	1	0.92	
25°	0.5	0.38	1	0.76	
30°	0.5	0.33	1	0.66	
40°	0.5	0.26	1	0.52	

Bearing Numbers (°) Cage Symbol (°)				Basic Load Ratings (Matched) (N)		Limiting Speeds (1) (Matched) (min ⁻¹)		Load Center Spacings (mm)		Abutment and Fillet Dimensions (mm)		
Single	Standard	Option	Duplex	C_r	C_{0r}	Grease	Oil	DB	a_0 DF	d_b (°) min.	D_b max.	r_b (°) max.
7900 A5°	TYN	(M)	DB DF DT	4 700	2 900	32 000	43 000	13.5	1.5	—	20.8	0.15
7900 C°	TYN	(M),T	DB DF DT	4 900	3 050	38 000	53 000	10.3	1.7	—	20.8	0.15
7000 A°	W	(M), T, TYN	DB DF DT	8 750	5 200	24 000	34 000	18.4	2.4	11.2	24.8	0.15
7000 C°	TYN	W,(M),T	DB DF DT	8 650	5 000	36 000	50 000	12.8	3.2	—	24.8	0.15
7200 A°	W	(M), TYN	DB DF DT	8 800	5 400	22 000	30 000	20.5	2.5	12.5	27.5	0.3
7200 B	W	(M), T	DB DF DT	8 100	5 000	16 000	22 000	25.8	7.8	12.5	27.5	0.3
7200 C°	TYN	W,(M),T	DB DF DT	8 800	5 200	32 000	45 000	14.4	3.6	—	27.5	0.3
7300 A	W	(M), T	DB DF DT	15 100	8 600	16 000	22 000	24.0	2.0	12.5	32.5	0.3
7300 B	W	(M), T	DB DF DT	14 200	8 100	14 000	20 000	29.9	7.9	12.5	32.5	0.3
7901 A5°	TYN	(M),T	DB DF DT	5 200	3 550	30 000	43 000	14.4	2.4	—	22.8	0.15
7901 C°	TYN	(M),T	DB DF DT	5 450	3 700	36 000	50 000	10.8	1.2	—	22.8	0.15
7001 A°	W	(M), T, TYN	DB DF DT	9 400	5 950	22 000	30 000	19.5	3.5	13.2	26.8	0.15
7001 C°	TYN	W,(M),T	DB DF DT	9 400	5 800	32 000	45 000	13.4	2.6	—	26.8	0.15
7201 A°	W	(M), T, TYN	DB DF DT	13 000	8 050	20 000	28 000	22.7	2.7	14.5	29.5	0.3
7201 B	W	(M),T	DB DF DT	12 100	7 500	15 000	20 000	28.5	8.5	14.5	29.5	0.3
7201 BEA°	T85	—	—	—	—	16 000	24 000	28.5	8.5	14.5	29.5	0.3
7201 C°	TYN	W,(M),T	DB DF DT	12 800	7 700	30 000	40 000	15.9	4.1	—	29.5	0.3
7301 A	W	(M), T	DB DF DT	15 400	9 000	15 000	20 000	26.1	2.1	17	32	0.6
7301 B	W	(M), T	DB DF DT	14 400	8 400	13 000	18 000	32.6	8.6	17	32	0.6
7301 BEA°	T85	—	—	—	—	15 000	22 000	32.6	8.6	17	32	0.6
7902 A5°	TYN	(M),T	DB DF DT	7 400	5 050	26 000	34 000	17.0	3.0	—	26.8	0.15
7902 C°	TYN	(M),T	DB DF DT	7 750	5 300	30 000	43 000	12.8	1.2	—	26.8	0.15
7002 A°	W	(M), T, TYN	DB DF DT	9 950	6 850	19 000	26 000	22.6	4.6	16.2	30.8	0.15
7002 C°	TYN	W, (M),T	DB DF DT	10 100	6 750	28 000	38 000	15.3	2.7	—	30.8	0.15
7202 A°	W	(M), T, TYN	DB DF DT	14 000	9 300	18 000	24 000	25.4	3.4	17.5	32.5	0.3
7202 B	W	(M),T	DB DF DT	12 900	8 600	13 000	18 000	32.0	10.0	17.5	32.5	0.3
7202 BEA°	T85	—	—	—	—	14 000	20 000	32.0	10.0	17.5	32.5	0.3
7202 C°	TYN	W,(M),T	DB DF DT	14 100	9 050	26 000	36 000	17.7	4.3	—	32.5	0.3
7302 A	W	(M), T	DB DF DT	21 800	14 200	13 000	17 000	29.5	3.5	20	37	0.6
7302 B	W	(M), T	DB DF DT	20 200	13 200	11 000	15 000	36.9	10.9	20	37	0.6
7302 BEA°	T85	—	—	—	—	13 000	18 000	36.9	10.9	20	37	0.6

Note (°) (M) in the column of cage symbols are usually omitted from the bearing number.

Remark The bearings denoted by an asterisk (*) are NSKHPS Angular contact ball bearings and the column of Duplex in Bearing Numbers indicates the universal matching.

Angular Contact Ball Bearings

Single/matched mountings Bore Diameter 17 – 25 mm

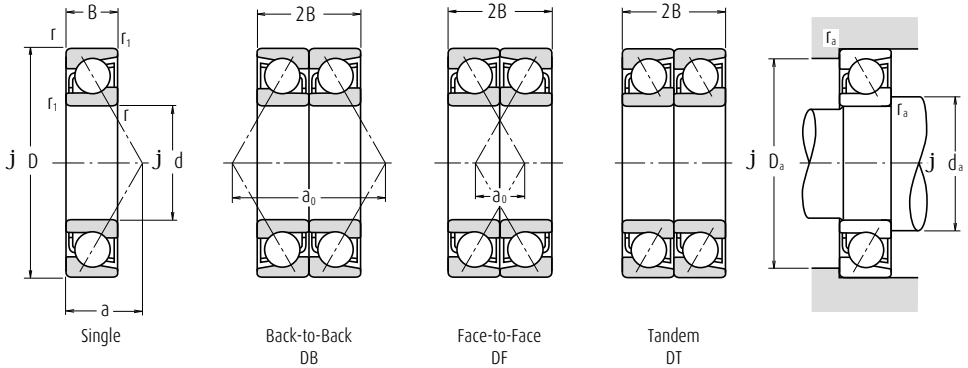

Boundary Dimensions (mm)					Basic Load Ratings (Single) (N)		Factor	Limiting Speeds (1) (min ⁻¹)		Eff. Load Centers (mm)	Abutment and Fillet Dimensions (mm)			Mass (kg)
d	D	B	r min.	r ₁ min.	C _r	C _{0r}	f ₀	Grease	Oil	a	d _a min.	D _a max.	r _a max.	approx.
17	30	7	0.3	0.15	5 000	2 800	—	42 600	63 900	9.0	19.5	27.5	0.3	0.017
	30	7	0.3	0.15	5 250	2 940	14.8	49 000	74 500	6.6	19.5	27.5	0.3	0.017
	35	10	0.3	0.15	6 400	3 500	—	22 900	30 500	12.5	19.5	32.5	0.3	0.040
	35	10	0.3	0.15	6 950	3 800	14.5	44 300	67 400	8.5	19.5	32.5	0.3	0.044
	40	12	0.6	0.3	10 700	5 450	—	26 400	35 100	14.2	22	35	0.6	0.067
	40	12	0.6	0.3	9 950	5 500	—	14 000	19 000	18.0	22	35	0.6	0.068
	40	12	0.6	0.3	11 600	6 100	—	16 000	22 000	18.2	22	35	0.6	0.065
	40	12	0.6	0.3	11 400	5 850	13.3	40 400	61 500	9.8	22	35	0.6	0.075
	47	14	1	0.6	15 900	8 650	—	14 000	19 000	16.2	23	41	1	0.116
	47	14	1	0.6	14 800	8 000	—	13 000	17 000	20.4	23	41	1	0.118
47	14	1	0.6	16 800	8 300	—	14 000	20 000	20.4	23	41	1	0.113	
20	37	9	0.3	0.15	6 950	4 050	—	35 100	52 700	11.1	22.5	34.5	0.3	0.036
	37	9	0.3	0.15	7 300	4 250	14.9	40 400	61 500	8.3	22.5	34.5	0.3	0.036
	42	12	0.6	0.3	10 800	6 100	—	24 200	32 300	14.9	25	37	0.6	0.068
	42	12	0.6	0.3	11 700	6 550	14.0	37 100	56 500	10.1	25	37	0.6	0.076
	47	14	1	0.6	14 300	7 550	—	22 400	29 900	16.7	26	41	1	0.106
	47	14	1	0.6	13 300	7 650	—	12 000	16 000	21.1	26	41	1	0.109
	47	14	1	0.6	15 600	8 150	—	13 000	19 000	21.1	26	41	1	0.103
	47	14	1	0.6	15 300	8 050	13.3	34 400	52 300	11.5	26	41	1	0.118
	52	15	1.1	0.6	18 700	10 400	—	13 000	17 000	17.9	27	45	1	0.146
	52	15	1.1	0.6	17 300	9 650	—	11 000	15 000	22.6	27	45	1	0.15
25	52	15	1.1	0.6	19 800	10 500	—	13 000	18 000	22.6	27	45	1	0.149
	42	9	0.3	0.15	7 800	5 150	—	29 900	44 800	12.3	27.5	39.5	0.3	0.043
	42	9	0.3	0.15	8 250	5 400	15.5	34 400	52 300	9.0	27.5	39.5	0.3	0.042
	47	12	0.6	0.3	11 300	6 850	—	22 900	27 800	16.4	30	42	0.6	0.079
	47	12	0.6	0.3	12 300	7 400	14.7	32 000	48 700	10.8	30	42	0.6	0.089
	52	15	1	0.6	16 100	9 450	—	19 500	26 000	18.6	31	46	1	0.13
	52	15	1	0.6	14 800	9 400	—	10 000	14 000	23.7	31	46	1	0.133
	52	15	1	0.6	17 600	10 200	—	12 000	17 000	23.7	31	46	1	0.127
	52	15	1	0.6	17 400	10 200	14.0	29 900	45 500	12.7	31	46	1	0.143
	62	17	1.1	0.6	26 400	15 800	—	10 000	14 000	21.1	32	55	1	0.235

- Notes**
- (1) For applications operating near the limiting speed, refer to Page B079.
 - (2) The suffixes A, A5, B, and C represent contact angles of 30°, 25°, 40°, and 15° respectively.
 - (3) For bearings marked — in the column for d_b, d₀ and r₀ for shafts are d_a (min.) and r_a (max.) respectively.

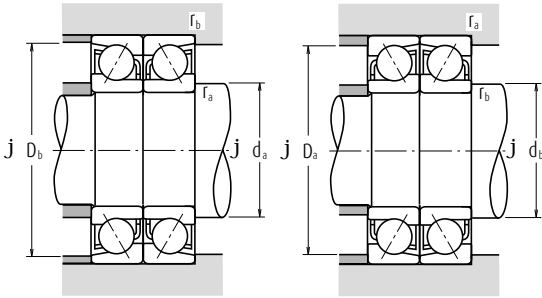

Dynamic Equivalent Load $P = X F_r + Y F_a$

Contact Angle	$\frac{i f_a F_a^*}{C_{or}}$	e	Single, DT				DB or DF			
			$F_a/F_r \leq e$		$F_a/F_r > e$		$F_a/F_r \leq e$		$F_a/F_r > e$	
			X	Y	X	Y	X	Y	X	Y
15°	0.178	0.38	1	0	0.44	1.47	1	1.65	0.72	2.39
	0.357	0.40	1	0	0.44	1.40	1	1.57	0.72	2.28
	0.714	0.43	1	0	0.44	1.30	1	1.46	0.72	2.11
	1.07	0.46	1	0	0.44	1.23	1	1.38	0.72	2.00
	1.43	0.47	1	0	0.44	1.19	1	1.34	0.72	1.93
	2.14	0.50	1	0	0.44	1.12	1	1.26	0.72	1.82
	3.57	0.55	1	0	0.44	1.02	1	1.14	0.72	1.66
	5.35	0.56	1	0	0.44	1.00	1	1.12	0.72	1.63
25°	—	0.68	1	0	0.41	0.87	1	0.92	0.67	1.41
30°	—	0.80	1	0	0.39	0.76	1	0.78	0.63	1.24
40°	—	1.14	1	0	0.35	0.57	1	0.55	0.57	0.93

*For i, use 2 for DB, DF and 1 for DT

Static Equivalent Load $P_0 = X_0 F_r + Y_0 F_a$

Contact Angle	Single, DT		DB or DF		Single or DT mounting When $F_r > 0.5 F_r + Y_0 F_a$ use $P_0 = F_r$
	X_0	Y_0	X_0	Y_0	
15°	0.5	0.46	1	0.92	
25°	0.5	0.38	1	0.76	
30°	0.5	0.33	1	0.66	
40°	0.5	0.26	1	0.52	

Bearing Numbers (°) Cage Symbol (°)				Basic Load Ratings (Matched) (N)		Limiting Speeds (1) (Matched) (min ⁻¹)		Load Center Spacings (mm)		Abutment and Fillet Dimensions (mm)		
Single	Standard	Option	Duplex	C_r	C_{or}	Grease	Oil	DB	a_0 DF	d_b (°) min.	D_b max.	r_b (°) max.
7903 A5°	TYN	(M),T	DB DF DT	7 750	5 600	24 000	32 000	18.0	4.0	—	28.8	0.15
7903 C°	TYN	(M),T	DB DF DT	8 150	5 850	28 000	38 000	13.3	0.7	—	28.8	0.15
7003 A°	W	(M), T, TYN	DB DF DT	10 400	7 650	17 000	24 000	25.0	5.0	18.2	33.8	0.15
7003 C°	TYN	W, (M), T	DB DF DT	10 700	7 600	26 000	34 000	17.0	3.0	—	33.8	0.15
7203 A°	W	(M), T, TYN	DB DF DT	17 600	12 000	16 000	22 000	28.5	4.5	19.5	37.5	0.3
7203 B	W	(M), T	DB DF DT	16 100	11 000	11 000	15 000	35.9	11.9	19.5	37.5	0.3
7203 BEA°	T85	T7	— — —	—	—	13 000	18 000	36.3	12.3	19.5	37.5	0.3
7203 C°	TYN	W, (M), T	DB DF DT	17 600	11 700	22 000	32 000	19.6	4.4	—	37.5	0.3
7303 A	W	(M), T	DB DF DT	25 900	17 300	11 000	15 000	32.5	4.5	22	42	0.6
7303 B	W	(M), T	DB DF DT	24 000	16 000	10 000	14 000	40.9	12.9	22	42	0.6
7303 BEA°	T85	—	— — —	—	—	11 000	16 000	40.9	12.9	22	42	0.6
7904 A5°	TYN	(M),T	DB DF DT	10 700	8 100	19 000	26 000	22.3	4.3	—	35.8	0.15
7904 C°	TYN	(M),T	DB DF DT	11 300	8 500	22 000	32 000	16.6	1.4	—	35.8	0.15
7004 A°	W	(M), T, TYN	DB DF DT	17 600	13 200	15 000	20 000	29.9	5.9	22.5	39.5	0.3
7004 C°	TYN	W, (M), T	DB DF DT	18 000	13 100	20 000	30 000	20.3	3.7	—	39.5	0.3
7204 A°	W	(M), T, TYN	DB DF DT	23 500	16 600	13 000	19 000	33.3	5.3	25	42	0.6
7204 B	W	(M), T	DB DF DT	21 600	15 300	9 500	13 000	42.1	14.1	25	42	0.6
7204 BEA°	T85	T7	— — —	—	—	11 000	16 000	42.1	14.1	25	42	0.6
7204 C°	TYN	W, (M), T	DB DF DT	23 600	16 100	19 000	26 000	23.0	5.0	—	42	0.6
7304 A	W	(M), T	DB DF DT	30 500	20 800	10 000	13 000	35.8	5.8	25	47	0.6
7304 B	W	(M), T	DB DF DT	28 200	19 300	9 000	12 000	45.2	15.2	25	47	0.6
7304 BEA°	T85	MR, T7	— — —	—	—	10 000	14 000	45.2	15.2	25	47	0.6
7905 A5°	TYN	(M),T	DB DF DT	12 100	10 300	16 000	22 000	24.6	6.6	—	40.8	0.15
7905 C°	TYN	(M),T	DB DF DT	12 700	10 800	19 000	26 000	18.0	0.0	—	40.8	0.15
7005 A°	W	(M), T, TYN	DB DF DT	18 300	14 800	13 000	17 000	32.8	8.8	27.5	44.5	0.3
7005 C°	TYN	W, (M), T	DB DF DT	19 000	14 800	18 000	26 000	21.6	2.4	—	44.5	0.3
7205 A°	W	(M), T, TYN	DB DF DT	26 300	20 500	12 000	16 000	37.2	7.2	30	47	0.6
7205 B	W	(M), T	DB DF DT	24 000	18 800	8 500	11 000	47.3	17.3	30	47	0.6
7205 BEA°	T85	T7	— — —	—	—	9 500	14 000	47.3	17.3	30	47	0.6
7205 C°	TYN	W, (M), T	DB DF DT	27 000	20 400	17 000	24 000	25.3	4.7	—	47	0.6
7305 A	W	(M), T	DB DF DT	43 000	31 500	8 500	11 000	42.1	8.1	30	57	0.6

Note (°) (M) in the column of cage symbols are usually omitted from the bearing number.

Remark The bearings denoted by an asterisk (*) are NSKHPS Angular contact ball bearings and the column of Duplex in Bearing Numbers indicates the universal matching.

Angular Contact Ball Bearings

Single/matched mountings Bore Diameter 25 – 40 mm

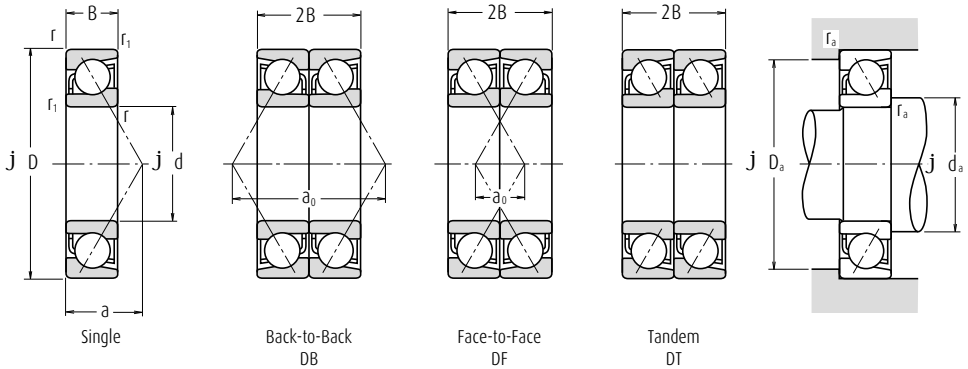

Boundary Dimensions (mm)					Basic Load Ratings (Single) (N)		Factor	Limiting Speeds ⁽¹⁾ (min ⁻¹)		Eff. Load Centers (mm)	Abutment and Fillet Dimensions (mm)			Mass (kg)
d	D	B	r min.	r ₁ min.	C _r	C _{0r}	f ₀	Grease	Oil	a	d _a min.	D _a max.	r _a max.	approx.
25	62	17	1.1	0.6	24 400	14 600	—	9 000	13 000	26.7	32	55	1	0.241
	62	17	1.1	0.6	27 200	14 900	—	10 000	15 000	26.8	32	55	1	0.229
30	47	9	0.3	0.15	8 250	5 950	—	26 000	39 000	13.5	32.5	44.5	0.3	0.049
	47	9	0.3	0.15	8 700	6 250	15.9	29 900	45 500	9.7	32.5	44.5	0.3	0.049
	55	13	1	0.6	14 600	9 450	—	17 700	23 600	18.8	36	49	1	0.116
	55	13	1	0.6	15 900	10 300	14.9	27 100	41 200	12.2	36	49	1	0.134
	62	16	1	0.6	22 400	13 600	—	16 400	21 800	21.3	36	56	1	0.197
	62	16	1	0.6	20 500	13 500	—	8 500	12 000	27.3	36	56	1	0.202
	62	16	1	0.6	23 700	14 300	—	10 000	14 000	27.3	36	56	1	0.194
	62	16	1	0.6	24 200	14 700	13.9	25 000	38 100	14.2	36	56	1	0.222
	72	19	1.1	0.6	33 500	20 900	—	9 000	12 000	24.2	37	65	1	0.346
	72	19	1.1	0.6	31 000	19 300	—	8 000	11 000	30.9	37	65	1	0.354
	72	19	1.1	0.6	36 500	20 600	—	9 000	13 000	30.9	37	65	1	0.336
35	55	10	0.6	0.3	12 000	8 700	—	22 300	33 400	15.5	40	50	0.6	0.074
	55	10	0.6	0.3	12 700	9 150	15.7	25 600	38 900	11.0	40	50	0.6	0.074
	62	14	1	0.6	18 400	12 600	—	15 500	20 700	21.0	41	56	1	0.153
	62	14	1	0.6	20 100	13 700	15.0	23 800	36 100	13.5	41	56	1	0.173
	72	17	1.1	0.6	29 600	18 500	—	14 100	18 700	23.9	42	65	1	0.287
	72	17	1.1	0.6	27 100	18 400	—	7 500	10 000	30.9	42	65	1	0.294
	72	17	1.1	0.6	32 500	19 600	—	8 500	12 000	30.9	42	65	1	0.271
	72	17	1.1	0.6	32 000	19 900	13.9	21 500	32 800	15.7	42	65	1	0.32
	80	21	1.5	1	40 000	26 300	—	8 000	10 000	27.1	44	71	1.5	0.469
	80	21	1.5	1	40 500	24 400	—	5 600	7 500	34.6	44	71	1.5	0.474
	80	21	1.5	1	40 500	24 400	—	8 000	11 000	34.6	44	71	1.5	0.451
40	62	12	0.6	0.3	14 300	11 200	—	14 000	18 000	17.9	45	57	0.6	0.11
	62	12	0.6	0.3	15 900	11 700	15.7	22 600	34 400	12.8	45	57	0.6	0.109
	68	15	1	0.6	19 700	14 600	—	13 900	18 600	23.1	46	62	1	0.19
	68	15	1	0.6	21 600	15 900	15.4	21 300	32 500	14.7	46	62	1	0.213
	80	18	1.1	0.6	35 500	23 300	—	12 500	16 700	26.3	47	73	1	0.375
	80	18	1.1	0.6	32 000	23 000	—	6 700	9 000	34.2	47	73	1	0.383

- Notes**
- (1) For applications operating near the limiting speed, refer to Page B079.
 - (2) The suffixes A, A5, B, and C represent contact angles of 30°, 25°, 40°, and 15° respectively.
 - (3) For bearings marked — in the column for d_b , d_0 and r_b for shafts are d_a (min.) and r_a (max.) respectively.

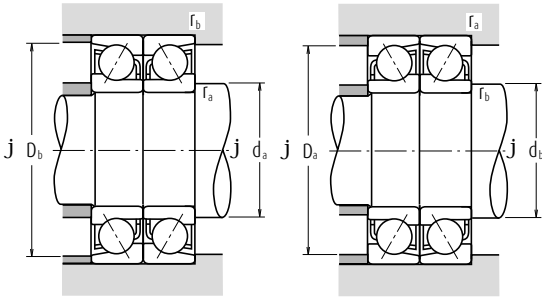

Dynamic Equivalent Load $P = X F_r + Y F_a$

Contact Angle	$\frac{i f_a F_a^*}{C_{or}}$	e	Single, DT				DB or DF			
			$F_a/F_r \leq e$		$F_a/F_r > e$		$F_a/F_r \leq e$		$F_a/F_r > e$	
			X	Y	X	Y	X	Y	X	Y
15°	0.178	0.38	1	0	0.44	1.47	1	1.65	0.72	2.39
	0.357	0.40	1	0	0.44	1.40	1	1.57	0.72	2.28
	0.714	0.43	1	0	0.44	1.30	1	1.46	0.72	2.11
	1.07	0.46	1	0	0.44	1.23	1	1.38	0.72	2.00
	1.43	0.47	1	0	0.44	1.19	1	1.34	0.72	1.93
	2.14	0.50	1	0	0.44	1.12	1	1.26	0.72	1.82
	3.57	0.55	1	0	0.44	1.02	1	1.14	0.72	1.66
	5.35	0.56	1	0	0.44	1.00	1	1.12	0.72	1.63
25°	—	0.68	1	0	0.41	0.87	1	0.92	0.67	1.41
30°	—	0.80	1	0	0.39	0.76	1	0.78	0.63	1.24
40°	—	1.14	1	0	0.35	0.57	1	0.55	0.57	0.93

*For i, use 2 for DB, DF and 1 for DT

Static Equivalent Load $P_0 = X_0 F_r + Y_0 F_a$

Contact Angle	Single, DT		DB or DF		Single or DT mounting When $F_r > 0.5 F_r + Y_0 F_a$ use $P_0 = F_r$
	X_0	Y_0	X_0	Y_0	
15°	0.5	0.46	1	0.92	
25°	0.5	0.38	1	0.76	
30°	0.5	0.33	1	0.66	
40°	0.5	0.26	1	0.52	

Bearing Numbers (²) Cage Symbol (¹)				Basic Load Ratings (Matched) (N)		Limiting Speeds (¹) (Matched) (min⁻¹)		Load Center Spacings (mm)		Abutment and Fillet Dimensions (mm)		
Single	Standard	Option	Duplex	C_r	C_{or}	Grease	Oil	DB	a_0 DF	d_b (²) min.	D_b max.	r_b (²) max.
7305 B	W	(M), T	DB DF DT	39 500	29 300	7 500	10 000	53.5	19.5	30	57	0.6
7305 BEA*	T85	MR, T7	— — —	—	—	8 500	12 000	53.5	19.5	30	57	0.6
7906 A5°	TYN	(M), T	DB DF DT	12 800	11 900	14 000	19 000	27.0	9.0	—	45.8	0.15
7906 C°	TYN	(M), T	DB DF DT	13 500	12 500	17 000	24 000	19.3	1.3	—	45.8	0.15
7006 A*	W	(M), T, TYN	DB DF DT	23 600	20 200	11 000	15 000	37.5	11.5	35	50	0.6
7006 C*	TYN	W, (M), T	DB DF DT	24 600	20 500	15 000	22 000	24.4	1.6	—	50	0.6
7206 A*	W	(M), T, TYN	DB DF DT	36 500	29 500	10 000	13 000	42.6	10.6	35	57	0.6
7206 B	W	(M), T	DB DF DT	33 500	27 000	7 100	9 500	54.6	22.6	35	57	0.6
7206 BEA*	T85	MR, T7	— — —	—	—	8 000	11 000	54.6	22.6	35	57	0.6
7206 C*	TYN	W, (M), T	DB DF DT	37 500	29 300	14 000	20 000	28.3	3.7	—	57	0.6
7306 A	W	(M), T	DB DF DT	54 500	41 500	7 100	9 500	48.4	10.4	35	67	0.6
7306 B	W	(M), T	DB DF DT	50 500	38 500	6 300	8 500	61.8	23.8	35	67	0.6
7306 BEA*	T85	MR, T7	— — —	—	—	7 100	10 000	61.8	23.8	35	67	0.6
7907 A5°	TYN	(M), T	DB DF DT	18 600	17 400	12 000	17 000	31.0	11.0	—	52.5	0.3
7907 C*	TYN	(M), T	DB DF DT	19 600	18 300	14 000	20 000	22.1	2.1	—	52.5	0.3
7007 A*	W	(M), T, TYN	DB DF DT	29 700	26 800	9 500	13 000	42.0	14.0	40	57	0.6
7007 C*	TYN	W, (M), T	DB DF DT	31 000	27 300	13 000	19 000	27.0	1.0	—	57	0.6
7207 A*	W	(M), T, TYN	DB DF DT	48 500	40 000	8 500	12 000	47.9	13.9	40	67	0.6
7207 BEA	W	MR, T7	DB DF DT	65 500	49 000	4 500	6000	69.2	27.2	41	74	1
7207 BEA*	T85	MR, T7	— — —	—	—	6 700	9 500	61.9	27.9	40	67	0.6
7207 C*	(M)	W, T, TYN	DB DF DT	49 500	40 000	12 000	17 000	31.3	2.7	—	67	0.6
7307 A	W	(M), T	DB DF DT	65 000	52 500	6 300	8 500	54.2	12.2	41	74	1
7307 B	W	(M), T	DB DF DT	59 500	48 500	5 600	7 500	69.2	27.2	41	74	1
7307 BEA*	T85	MR, T7	— — —	—	—	6 300	9 000	69.2	27.2	41	74	1
7908 A5	TYN	(M), T	DB DF DT	23 300	22 300	11 000	15 000	35.8	11.8	—	59.5	0.3
7908 C*	TYN	(M), T	DB DF DT	24 600	23 500	13 000	18 000	25.7	1.7	—	59.5	0.3
7008 A*	W	(M), T, TYN	DB DF DT	31 500	31 000	8 500	11 000	46.2	16.2	45	63	0.6
7008 C*	(M)	W, T, TYN	DB DF DT	33 500	32 000	12 000	17 000	29.5	0.5	—	63	0.6
7208 A*	W	(M), T, TYN	DB DF DT	57 500	50 500	7 500	10 000	52.6	16.6	45	75	0.6
7208 B	W	(M), T	DB DF DT	52 000	46 000	5 300	7 500	68.3	32.3	45	75	0.6

Note (¹) (M) in the column of cage symbols are usually omitted from the bearing number.

Remark The bearings denoted by an asterisk (*) are NSKHPS Angular contact ball bearings and the column of Duplex in Bearing Numbers indicates the universal matching.

Angular Contact Ball Bearings

Single/matched mountings Bore Diameter 40 – 55 mm

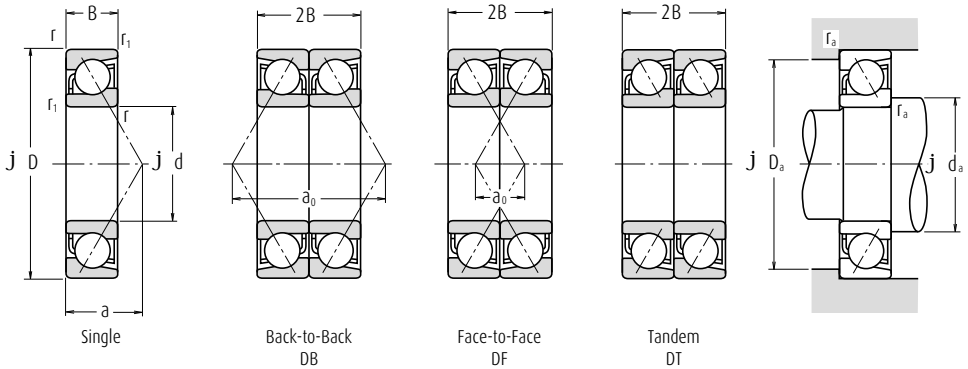

Boundary Dimensions (mm)					Basic Load Ratings (Single) (N)		Factor	Limiting Speeds ⁽¹⁾ (min ⁻¹)		Eff. Load Centers (mm)	Abutment and Fillet Dimensions (mm)			Mass (kg)
d	D	B	r min.	r ₁ min.	C _r	C _{0r}	f ₀	Grease	Oil	a	d _s min.	D _s max.	r _a max.	approx.
40	80	18	1.1	0.6	38 500	24 500	—	7 500	11 000	34.2	47	73	1	0.357
	80	18	1.1	0.6	38 000	25 200	14.1	19 200	29 200	17.0	47	73	1	0.418
	90	23	1.5	1	49 000	33 000	—	7 100	9 000	30.3	49	81	1.5	0.633
	90	23	1.5	1	53 000	33 000	—	5 000	6 700	38.8	49	81	1.5	0.644
	90	23	1.5	1	53 000	33 000	—	7 100	10 000	38.8	49	81	1.5	0.619
45	68	12	0.6	0.3	15 900	12 700	—	17 700	26 600	19.2	50	63	0.6	0.13
	68	12	0.6	0.3	16 800	13 400	16.0	20 400	31 000	13.6	50	63	0.6	0.129
	75	16	1	0.6	23 400	17 700	—	12 500	16 700	25.3	51	69	1	0.25
	75	16	1	0.6	25 600	19 300	15.4	19 200	29 200	16.0	51	69	1	0.274
	85	19	1.1	0.6	39 500	26 700	—	11 600	15 400	28.3	52	78	1	0.411
	85	19	1.1	0.6	36 000	26 200	—	6 300	8 500	36.8	52	78	1	0.421
	85	19	1.1	0.6	40 500	27 100	—	7 100	10 000	36.8	52	78	1	0.40
	85	19	1.1	0.6	43 000	28 800	14.2	17 700	27 000	18.2	52	78	1	0.468
	100	25	1.5	1	63 500	43 500	—	6 300	8 500	33.4	54	91	1.5	0.848
	100	25	1.5	1	62 500	39 500	—	4 500	6 000	42.9	54	91	1.5	0.860
50	100	25	1.5	1	62 500	39 500	—	6 300	9 000	42.9	54	91	1.5	0.823
	72	12	0.6	0.3	16 700	14 200	—	16 400	24 600	20.2	55	67	0.6	0.132
	72	12	0.6	0.3	17 700	15 000	16.2	18 900	28 700	14.2	55	67	0.6	0.13
	80	16	1	0.6	24 900	21 100	—	11 600	15 400	26.8	56	74	1	0.263
	80	16	1	0.6	27 300	21 900	15.7	17 700	27 000	16.7	56	74	1	0.293
	90	20	1.1	0.6	41 500	29 300	—	10 800	14 300	30.2	57	83	1	0.466
	90	20	1.1	0.6	37 500	28 600	—	5 600	8 000	39.4	57	83	1	0.477
	90	20	1.1	0.6	42 000	29 700	—	6 300	9 500	39.4	57	83	1	0.453
	90	20	1.1	0.6	45 000	31 500	14.5	16 500	25 000	19.4	57	83	1	0.528
	110	27	2	1	74 000	52 000	—	5 600	7 500	36.6	60	100	2	1.1
55	110	27	2	1	78 000	50 500	—	4 000	5 600	47.1	60	100	2	1.11
	110	27	2	1	78 000	50 500	—	5 600	8 000	47.1	60	100	2	1.07
	80	13	1	0.6	19 000	16 800	—	14 900	22 300	22.2	61	74	1	0.184
80	13	1	0.6	20 100	17 700	16.3	17 100	26 000	15.5	61	74	1	0.182	
90	18	1.1	0.6	32 500	26 300	—	17 400	13 800	29.9	62	83	1	0.391	

- Notes**
- (1) For applications operating near the limiting speed, refer to Page B079.
 - (2) The suffixes A, A5, B, and C represent contact angles of 30°, 25°, 40°, and 15° respectively.
 - (3) For bearings marked — in the column for d₀, d_b and r₀ for shafts are d_s (min.) and r_a (max.) respectively.

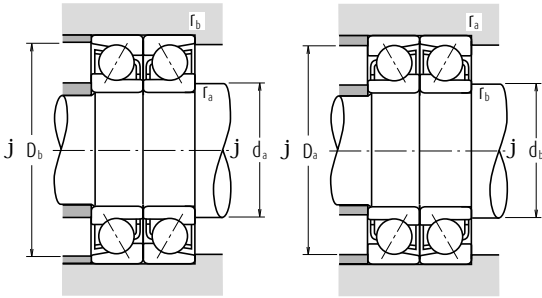

Dynamic Equivalent Load $P = X F_r + Y F_a$

Contact Angle	$\frac{i f_a F_a^*}{C_{or}}$	e	Single, DT				DB or DF			
			$F_a/F_r \leq e$		$F_a/F_r > e$		$F_a/F_r \leq e$		$F_a/F_r > e$	
			X	Y	X	Y	X	Y	X	Y
15°	0.178	0.38	1	0	0.44	1.47	1	1.65	0.72	2.39
	0.357	0.40	1	0	0.44	1.40	1	1.57	0.72	2.28
	0.714	0.43	1	0	0.44	1.30	1	1.46	0.72	2.11
	1.07	0.46	1	0	0.44	1.23	1	1.38	0.72	2.00
	1.43	0.47	1	0	0.44	1.19	1	1.34	0.72	1.93
	2.14	0.50	1	0	0.44	1.12	1	1.26	0.72	1.82
	3.57	0.55	1	0	0.44	1.02	1	1.14	0.72	1.66
25°	—	0.68	1	0	0.41	0.87	1	0.92	0.67	1.41
	—	0.80	1	0	0.39	0.76	1	0.78	0.63	1.24
	—	1.14	1	0	0.35	0.57	1	0.55	0.57	0.93

*For i, use 2 for DB, DF and 1 for DT

Static Equivalent Load $P_0 = X_0 F_r + Y_0 F_a$

Contact Angle	Single, DT		DB or DF		Single or DT mounting When $F_r > 0.5 F_r + Y_0 F_a$ use $P_0 = F_r$
	X_0	Y_0	X_0	Y_0	
15°	0.5	0.46	1	0.92	
25°	0.5	0.38	1	0.76	
30°	0.5	0.33	1	0.66	
40°	0.5	0.26	1	0.52	

Bearing Numbers (²) Cage Symbol (⁴)				Basic Load Ratings (Matched) (N)		Limiting Speeds (¹) (Matched) (min⁻¹)		Load Center Spacings (mm)		Abutment and Fillet Dimensions (mm)		
Single	Standard	Option	Duplex	C_r	C_{or}	Grease	Oil	DB	a_0 DF	d_b (²) min.	D_b max.	r_b (²) max.
7208 BEA*	T85	MR, T7		—	—	6 000	8 500	68.3	32.3	45	75	0.6
7208 C*	(M)	W, T, TYN	DB DF DT	59 000	50 500	11 000	15 000	34.1	1.9	—	75	0.6
7308 A	W	(M), T	DB DF DT	79 500	66 000	5 600	7 500	60.5	14.5	46	84	1
7308 BEA	W	MR, T7	DB DF DT	68 500	65 500	4 000	5 300	85.8	35.8	51	94	1
7308 BEA*	T85	MR, T7	—	—	—	5 600	8 000	77.5	31.5	46	84	1
7909 A5*	(M)	T, TYN	DB DF DT	24 600	25 400	9 500	13 000	38.4	14.4	—	65.5	0.3
7909 C*	(M)	T, TYN	DB DF DT	26 000	26 800	12 000	16 000	27.1	3.1	—	65.5	0.3
7009 A*	W	(M), TYN	DB DF DT	37 500	37 500	7 500	10 000	50.6	18.6	50	70	0.6
7009 C*	(M)	W, TYN	DB DF DT	39 500	38 500	11 000	15 000	32.1	0.1	—	70	0.6
7209 A*	W	(M), T, TYN	DB DF DT	64 500	57 500	7 100	9 500	56.5	18.5	50	80	0.6
7209 B	W	(M), T	DB DF DT	58 500	52 500	5 000	6 700	73.5	35.5	50	80	0.6
7209 BEA*	T85	MR, T7	—	—	—	5 600	8 000	73.5	35.5	50	80	0.6
7209 C*	(M)	W, T, TYN	DB DF DT	66 500	57 500	10 000	14 000	36.4	1.6	—	80	0.6
7309 A	W	(M), T	DB DF DT	103 000	87 000	5 000	6 700	66.9	16.9	51	94	1
7309 BEA	W	MR, T7	DB DF DT	102 000	79 500	3 600	4 800	85.8	35.8	51	94	1
7309 BEA*	T85	MR, T7	—	—	—	5 000	7 100	85.8	35.8	51	94	1
7910 A5*	(M)	T, TYN	DB DF DT	25 900	28 400	9 000	12 000	40.5	16.5	—	69.5	0.3
7910 C*	(M)	T, TYN	DB DF DT	27 400	30 000	11 000	15 000	28.3	4.3	—	69.5	0.3
7010 A*	W	(M), T, TYN	DB DF DT	40 000	42 000	7 100	9 500	53.5	21.5	55	75	0.6
7010 C*	(M)	W, T, TYN	DB DF DT	42 000	44 000	10 000	14 000	33.4	1.4	—	75	0.6
7210 A*	W	(M), T, TYN	DB DF DT	67 000	63 000	6 300	9 000	60.4	20.4	55	85	0.6
7210 B	W	(M), T	DB DF DT	60 500	57 000	4 500	6 300	78.7	38.7	55	85	0.6
7210 BEA*	T85	MR, T7	—	—	—	5 000	7 500	78.7	38.7	55	85	0.6
7210 C*	(M)	W, T, TYN	DB DF DT	69 500	63 500	9 500	13 000	38.7	1.3	—	85	0.6
7310 A	W	(M), T	DB DF DT	121 000	104 000	4 500	6 000	73.2	19.2	56	104	1
7310 BEA	W	MR, T7	DB DF DT	127 000	101 000	3 200	4 500	94.1	40.1	56	104	1
7310 BEA*	T85	MR, T7	—	—	—	4 500	6 700	94.1	40.1	56	104	1
7911 A5*	(M)	T, TYN	DB DF DT	29 300	33 500	8 000	11 000	44.5	18.5	—	75	0.6
7911 C*	(M)	T, TYN	DB DF DT	31 000	35 500	9 500	13 000	31.1	5.1	—	75	0.6
7011 A*	W	(M), T, TYN	DB DF DT	52 500	55 500	6 300	8 500	59.9	23.9	60	85	0.6

Note (⁴) (M) in the column of cage symbols are usually omitted from the bearing number.

Remark The bearings denoted by an asterisk (*) are NSKHPS Angular contact ball bearings and the column of Duplex in Bearing Numbers indicates the universal matching.

Angular Contact Ball Bearings

Single/matched mountings Bore Diameter 55 – 65 mm

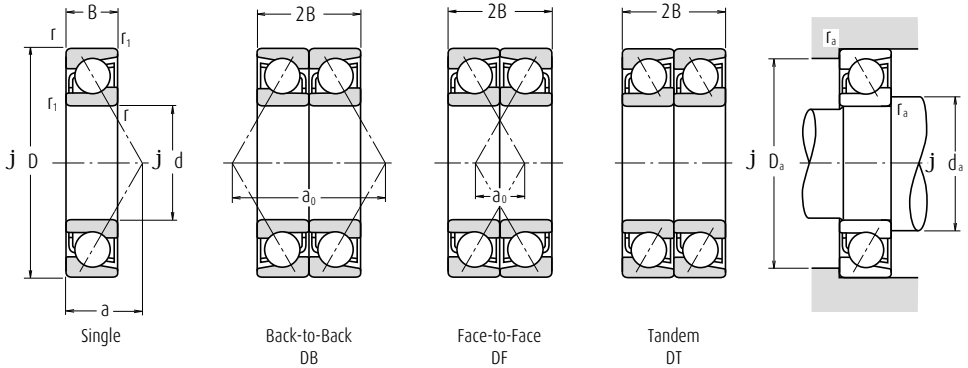

Boundary Dimensions (mm)					Basic Load Ratings (Single) (N)		Factor	Limiting Speeds (1) (min ⁻¹)		Eff. Load Centers (mm)	Abutment and Fillet Dimensions (mm)			Mass (kg)	
d	D	B	r min.	r ₁ min.	C _r	C _{0r}	f ₀	Grease	Oil	a	d _a min.	D _a max.	r _a max.	approx.	
55	90	18	1.1	0.6	36 000	28 600	15.5	15 900	24 200	18.7	62	83	1	0.43	
	100	21	1.5	1	51 000	37 000	—	9 700	13 000	32.9	64	91	1.5	0.613	
	100	21	1.5	1	46 500	36 000	—	5 300	7 100	43.0	64	91	1.5	0.627	
	100	21	1.5	1	51 500	37 000	—	6 000	8 500	43.0	64	91	1.5	0.596	
	100	21	1.5	1	55 500	40 000	14.5	14 900	22 600	20.9	64	91	1.5	0.688	
	120	29	2	1	86 000	61 500	—	5 000	6 700	39.8	65	110	2	1.41	
	120	29	2	1	89 000	58 500	—	3 600	5 000	51.2	65	110	2	1.42	
	120	29	2	1	89 000	58 500	—	5 000	7 500	51.2	65	110	2	1.36	
60	85	13	1	0.6	19 200	17 700	—	13 800	20 700	23.4	66	79	1	0.197	
	85	13	1	0.6	20 400	18 700	16.5	15 900	24 200	16.2	66	79	1	0.194	
	95	18	1.1	0.6	33 500	28 100	—	9 700	13 000	31.4	67	88	1	0.417	
	95	18	1.1	0.6	37 000	30 500	15.7	14 900	22 600	19.4	67	88	1	0.46	
	110	22	1.5	1	62 000	45 500	—	8 900	11 800	35.5	69	101	1.5	0.798	
	110	22	1.5	1	56 000	44 500	—	4 800	6 300	46.7	69	101	1.5	0.815	
	110	22	1.5	1	61 500	45 000	—	5 300	7 500	46.7	69	101	1.5	0.791	
	110	22	1.5	1	67 500	49 000	14.4	13 600	20 600	22.4	69	101	1.5	0.889	
65	130	31	2.1	1.1	98 000	71 500	—	4 800	6 300	42.9	72	118	2	1.74	
	130	31	2.1	1.1	102 000	68 500	—	3 400	4 500	55.4	72	118	2	1.77	
	130	31	2.1	1.1	102 000	68 500	—	4 800	6 700	55.4	72	118	2	1.7	
	65	90	13	1	0.6	20 000	19 400	—	13 000	19 400	24.6	71	84	1	0.211
		90	13	1	0.6	21 200	20 500	16.7	14 900	22 600	16.9	71	84	1	0.208
		100	18	1.1	0.6	33 500	31 500	—	9 100	12 200	32.8	72	93	1	0.455
		100	18	1.1	0.6	39 000	34 500	15.9	14 000	21 300	20.0	72	93	1	0.493
		120	23	1.5	1	70 500	54 000	—	8 200	10 900	38.2	74	111	1.5	1.03
120		23	1.5	1	63 500	52 500	—	4 300	6 000	50.3	74	111	1.5	1.05	
120		23	1.5	1	70 000	53 500	—	4 800	7 100	50.3	74	111	1.5	1.01	
120		23	1.5	1	77 000	58 500	14.6	12 500	19 000	23.9	74	111	1.5	1.14	
140	33	2.1	1.1	111 000	82 000	—	4 300	6 000	46.1	77	128	2	2.12		
140	33	2.1	1.1	114 000	77 000	—	3 200	4 300	59.5	77	128	2	2.17		
140	33	2.1	1.1	114 000	77 000	—	4 300	6 300	59.5	77	128	2	2.09		

- Notes**
- (1) For applications operating near the limiting speed, refer to Page B079.
 - (2) The suffixes A, A5, B, and C represent contact angles of 30°, 25°, 40°, and 15° respectively.
 - (3) For bearings marked — in the column for d_b , d_0 and r_b for shafts are d_a (min.) and r_a (max.) respectively.

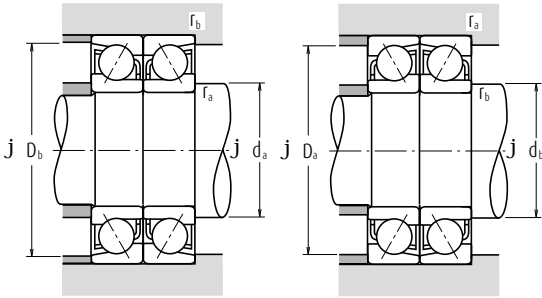

Dynamic Equivalent Load $P = X F_r + Y F_a$

Contact Angle	$\frac{i f_0 F_a^*}{C_{or}}$	e	Single, DT				DB or DF			
			$F_a/F_r \leq e$		$F_a/F_r > e$		$F_a/F_r \leq e$		$F_a/F_r > e$	
			X	Y	X	Y	X	Y	X	Y
15°	0.178	0.38	1	0	0.44	1.47	1	1.65	0.72	2.39
	0.357	0.40	1	0	0.44	1.40	1	1.57	0.72	2.28
	0.714	0.43	1	0	0.44	1.30	1	1.46	0.72	2.11
	1.07	0.46	1	0	0.44	1.23	1	1.38	0.72	2.00
	1.43	0.47	1	0	0.44	1.19	1	1.34	0.72	1.93
	2.14	0.50	1	0	0.44	1.12	1	1.26	0.72	1.82
	3.57	0.55	1	0	0.44	1.02	1	1.14	0.72	1.66
25°	—	0.68	1	0	0.41	0.87	1	0.92	0.67	1.41
	—	0.80	1	0	0.39	0.76	1	0.78	0.63	1.24
	—	1.14	1	0	0.35	0.57	1	0.55	0.57	0.93

*For i, use 2 for DB, DF and 1 for DT

Static Equivalent Load $P_0 = X_0 F_r + Y_0 F_a$

Contact Angle	Single, DT		DB or DF		Single or DT mounting When $F_r > 0.5 F_r + Y_0 F_a$ use $P_0 = F_r$
	X_0	Y_0	X_0	Y_0	
15°	0.5	0.46	1	0.92	
25°	0.5	0.38	1	0.76	
30°	0.5	0.33	1	0.66	
40°	0.5	0.26	1	0.52	

Bearing Numbers (²) Cage Symbol (⁴)				Basic Load Ratings (Matched) (N)		Limiting Speeds (¹) (Matched) (min⁻¹)		Load Center Spacings (mm)		Abutment and Fillet Dimensions (mm)		
Single	Standard	Option	Duplex	C_r	C_{or}	Grease	Oil	DB	a_0 DF	d_b (²) min.	D_b max.	r_b (²) max.
7011 C ^e	(M)	W,T, TYN	DB DF DT	55 500	57 500	9 000	12 000	37.4	1.4	—	85	0.6
7211 A ^e	W	(M), T, TYN	DB DF DT	83 000	79 000	6 000	8 000	65.7	23.7	61	94	1
7211 B	W	(M), T	DB DF DT	75 000	72 000	4 000	5 600	86.0	44.0	61	94	1
7211 BEA ^e	T85	MR, T7	— — —	—	—	4 500	6 700	86.0	44.0	61	94	1
7211 C ^e	(M)	W,T, TYN	DB DF DT	86 000	80 000	8 500	12 000	41.7	0.3	—	94	1
7311 A	W	(M), T	DB DF DT	139 000	123 000	4 000	5 600	79.5	21.5	61	114	1
7311 BEA	W	MR, T7	DB DF DT	145 000	117 000	3 000	4 000	102.4	44.4	61	114	1
7311 BEA ^e	T85	MR, T7	— — —	—	—	4 000	6 000	102.4	44.4	61	114	1
7912 A5 ^o	(M)	T, TYN	DB DF DT	29 800	35 500	7 500	10 000	46.8	20.8	—	80	0.6
7912 C ^e	(M)	T, TYN	DB DF DT	31 500	37 500	9 000	12 000	32.4	6.4	—	80	0.6
7012 A ^e	W	(M), T, TYN	DB DF DT	53 500	59 000	6 000	8 000	62.7	26.7	65	90	0.6
7012 C ^e	(M)	W, T, TYN	DB DF DT	57 000	61 500	8 500	12 000	38.8	2.8	—	90	0.6
7212 A ^e	W	(M), T, TYN	DB DF DT	100 000	97 500	5 300	7 100	71.1	27.1	66	104	1
7212 B	W	(M), T	DB DF DT	91 000	89 000	3 800	5 300	93.3	49.3	66	104	1
7212 BEA ^e	T85	MR, T7	— — —	—	—	4 300	6 000	93.3	49.3	66	104	1
7212 C ^e	(M)	W,T, TYN	DB DF DT	104 000	98 500	7 500	11 000	44.8	0.8	—	104	1
7312 A	W	(M), T	DB DF DT	159 000	143 000	3 800	5 000	85.9	23.9	67	123	1
7312 BEA	W	MR, T7	DB DF DT	166 000	137 000	2 600	3 800	110.7	48.7	67	123	1
7312 BEA ^e	T85	MR, T7	— — —	—	—	3 800	5 600	110.7	48.7	67	123	1
7913 A5 ^o	(M)	T, TYN	DB DF DT	31 000	39 000	7 100	9 500	49.1	23.1	—	85	0.6
7913 C ^e	(M)	T, TYN	DB DF DT	33 000	41 000	8 500	12 000	33.8	7.8	—	85	0.6
7013 A ^e	W	(M), T, TYN	DB DF DT	56 500	65 500	5 600	7 500	65.6	29.6	70	95	0.6
7013 C ^e	(M)	W, T, TYN	DB DF DT	60 500	68 500	8 000	11 000	40.1	4.1	—	95	0.6
7213 A ^e	W	(M), T, TYN	DB DF DT	114 000	116 000	4 800	6 700	76.4	30.4	71	114	1
7213 B	W	(M), T	DB DF DT	103 000	105 000	3 400	4 800	100.6	54.6	71	114	1
7213 BEA ^e	T85	MR, T7	— — —	—	—	3 800	5 600	100.6	54.6	71	114	1
7213 C ^e	(M)	W, T, TYN	DB DF DT	119 000	117 000	7 100	9 500	47.8	1.8	—	114	1
7313 A	W	(M), T	DB DF DT	180 000	164 000	3 600	4 800	92.2	26.2	72	133	1
7313 BEA	W	MR, T7	DB DF DT	184 000	154 000	2 400	3 400	119.0	53.0	72	133	1
7313 BEA ^e	T85	MR, T7	— — —	—	—	3 600	5 000	119.0	53.0	72	133	1

Note (⁴) (M) in the column of cage symbols are usually omitted from the bearing number.

Remark The bearings denoted by an asterisk (*) are NSKHPS Angular contact ball bearings and the column of Duplex in Bearing Numbers indicates the universal matching.

Angular Contact Ball Bearings

Single/matched mountings Bore Diameter 70 – 80 mm

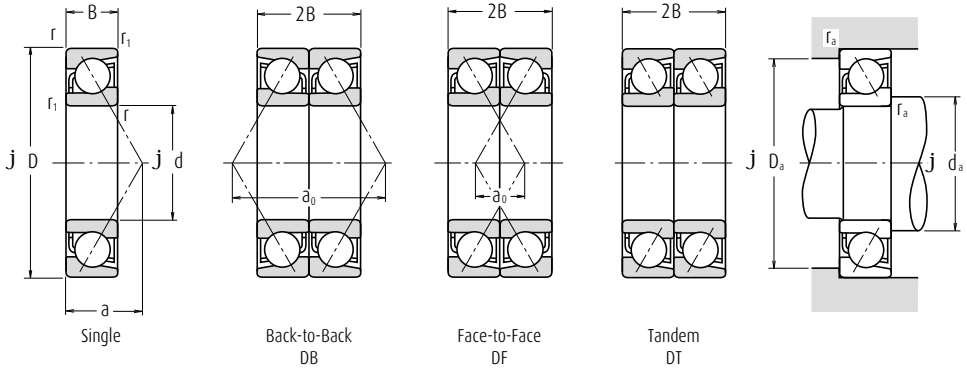

Boundary Dimensions (mm)					Basic Load Ratings (Single) (N)		Factor	Limiting Speeds (1) (min ⁻¹)		Eff. Load Centers (mm)	Abutment and Fillet Dimensions (mm)			Mass (kg)
d	D	B	r min.	r ₁ min.	C _r	C _{0r}	f ₀	Grease	Oil	a	d _a min.	D _a max.	r _a max.	approx.
70	100	16	1	0.6	27 900	26 300	—	11 800	17 700	27.8	76	94	1	0.341
	100	16	1	0.6	29 500	27 800	16.4	13 600	20 600	19.4	76	94	1	0.338
	110	20	1.1	0.6	45 000	39 500	—	8 400	11 200	36.0	77	103	1	0.625
	110	20	1.1	0.6	49 000	43 000	15.7	12 800	19 500	22.1	77	103	1	0.698
	125	24	1.5	1	77 000	59 500	—	7 700	10 300	40.1	79	116	1.5	1.11
	125	24	1.5	1	69 000	58 000	—	4 000	5 600	52.9	79	116	1.5	1.14
	125	24	1.5	1	75 500	58 500	—	4 500	6 700	52.9	79	116	1.5	1.08
	125	24	1.5	1	83 500	64 500	14.6	11 800	18 000	25.1	79	116	1.5	1.24
	150	35	2.1	1.1	125 000	93 500	—	4 000	5 300	49.3	82	138	2	2.6
	150	35	2.1	1.1	124 000	87 500	—	2 800	4 000	63.6	82	138	2	2.62
	150	35	2.1	1.1	124 000	87 500	—	4 000	6 000	63.7	82	138	2	2.53
	150	35	2.1	1.1	125 000	93 500	—	11 200	16 700	29.0	81	99	1	0.355
75	105	16	1	0.6	28 300	27 700	—	11 200	16 700	29.0	81	99	1	0.357
	105	16	1	0.6	30 000	29 300	16.6	12 800	19 500	20.1	81	99	1	0.357
	115	20	1.1	0.6	46 000	41 500	—	7 900	10 600	37.4	82	108	1	0.661
	115	20	1.1	0.6	50 500	45 500	15.9	12 200	18 500	22.7	82	108	1	0.748
	130	25	1.5	1	80 000	64 500	—	7 400	9 800	42.1	84	121	1.5	1.19
	130	25	1.5	1	68 500	58 500	—	3 800	5 300	55.5	84	121	1.5	1.22
	130	25	1.5	1	78 500	63 500	—	4 300	6 300	55.5	84	121	1.5	1.18
	130	25	1.5	1	87 000	70 000	14.8	11 300	17 100	26.2	84	121	1.5	1.36
	160	37	2.1	1.1	136 000	106 000	—	3 800	5 000	52.4	87	148	2	3.13
	160	37	2.1	1.1	134 000	98 500	—	2 800	3 800	67.8	87	148	2	3.13
	160	37	2.1	1.1	134 000	98 500	—	3 800	5 600	—	—	—	—	—
	80	110	16	1	0.6	28 700	29 000	—	10 600	15 800	30.2	86	104	1
110		16	1	0.6	30 500	30 500	16.7	12 200	18 500	20.7	86	104	1	0.376
125		22	1.1	0.6	56 000	50 500	—	7 400	9 800	40.6	87	118	1	0.88
125		22	1.1	0.6	61 500	55 500	15.7	11 300	17 100	24.7	87	118	1	0.966
140		26	2	1	89 500	71 500	—	6 900	9 100	44.8	90	130	2	1.46
140		26	2	1	80 500	69 500	—	3 600	5 000	59.1	90	130	2	1.49
140		26	2	1	87 500	70 000	—	4 000	6 000	59.2	87	148	2	1.42
140		26	2	1	97 500	77 500	14.7	10 500	16 000	27.7	90	130	2	1.63
170		39	2.1	1.1	147 000	119 000	—	3 600	4 800	55.6	92	158	2	3.71
170		39	2.1	1.1	144 000	110 000	—	2 600	3 400	71.9	92	158	2	3.84
170		39	2.1	1.1	144 000	110 000	—	3 600	5 300	—	—	—	—	—

- Notes**
- (1) For applications operating near the limiting speed, refer to Page B079.
 - (2) The suffixes A, A5, B, and C represent contact angles of 30°, 25°, 40°, and 15° respectively.
 - (3) For bearings marked — in the column for d₀, d_b and r_b for shafts are d_a (min.) and r_a (max.) respectively.

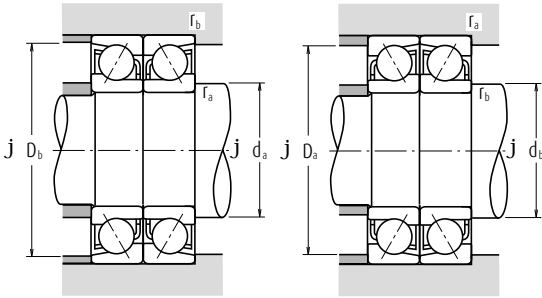

Dynamic Equivalent Load $P = X F_r + Y F_a$

Contact Angle	$\frac{i f_0 F_a^*}{C_{0r}}$	e	Single, DT				DB or DF			
			$F_a/F_r \leq e$		$F_a/F_r > e$		$F_a/F_r \leq e$		$F_a/F_r > e$	
			X	Y	X	Y	X	Y	X	Y
15°	0.178	0.38	1	0	0.44	1.47	1	1.65	0.72	2.39
	0.357	0.40	1	0	0.44	1.40	1	1.57	0.72	2.28
	0.714	0.43	1	0	0.44	1.30	1	1.46	0.72	2.11
	1.07	0.46	1	0	0.44	1.23	1	1.38	0.72	2.00
	1.43	0.47	1	0	0.44	1.19	1	1.34	0.72	1.93
	2.14	0.50	1	0	0.44	1.12	1	1.26	0.72	1.82
	3.57	0.55	1	0	0.44	1.02	1	1.14	0.72	1.66
	5.35	0.56	1	0	0.44	1.00	1	1.12	0.72	1.63
25°	—	0.68	1	0	0.41	0.87	1	0.92	0.67	1.41
30°	—	0.80	1	0	0.39	0.76	1	0.78	0.63	1.24
40°	—	1.14	1	0	0.35	0.57	1	0.55	0.57	0.93

*For i, use 2 for DB, DF and 1 for DT

Static Equivalent Load $P_0 = X_0 F_r + Y_0 F_a$

Contact Angle	Single, DT		DB or DF		Single or DT mounting When $F_r > 0.5 F_r + Y_0 F_a$ use $P_0 = F_r$
	X_0	Y_0	X_0	Y_0	
15°	0.5	0.46	1	0.92	
25°	0.5	0.38	1	0.76	
30°	0.5	0.33	1	0.66	
40°	0.5	0.26	1	0.52	

Bearing Numbers (²) Cage Symbol (⁴)				Basic Load Ratings (Matched) (N)		Limiting Speeds (¹) (Matched) (min⁻¹)		Load Center Spacings (mm)		Abutment and Fillet Dimensions (mm)		
Single	Standard	Option	Duplex	C_r	C_{0r}	Grease	Oil	DB	a_0 DF	d_b (²) min.	D_b max.	r_b (²) max.
7914 A5*	(M)	T,TYN	DB DF DT	43 000	52 500	6 300	9 000	55.6	23.6	—	95	0.6
7914 C*	(M)	T, TYN,T85	DB DF DT	45 500	55 500	7 500	11 000	38.8	6.8	—	95	0.6
7014 A*	W	(M), T,TYN	DB DF DT	71 500	82 500	5 000	6 700	72.0	32.0	75	105	0.6
7014 C*	(M)	W,T, TYN	DB DF DT	76 000	86 000	7 100	10 000	44.1	4.1	—	105	0.6
7214 A*	W	(M), T,TYN	DB DF DT	124 000	127 000	4 500	6 300	80.3	32.3	76	119	1
7214 B	W	(M),T	DB DF DT	112 000	116 000	3 200	4 500	105.8	57.8	76	119	1
7214 BEA*	T85	MR, T7	— — —	—	—	3 600	5 300	105.8	57.8	76	119	1
7214 C*	(M)	W,T,TYN,T7	DB DF DT	129 000	129 000	6 700	9 000	50.1	2.1	—	119	1
7314 A	W	(M), T	DB DF DT	203 000	187 000	3 200	4 300	98.5	28.5	77	143	1
7314 BEA	W	MR, T7	DB DF DT	201 000	175 000	2 400	3 200	127.3	57.3	77	143	1
7314 BEA*	T85	MR, T7	— — —	—	—	3 200	4 800	127.3	57.3	77	143	1
7915 A5*	(M)	TYN	DB DF DT	44 000	55 500	6 000	8 500	58.0	26.0	—	100	0.6
7915 C*	(M)	T, TYN	DB DF DT	46 500	58 500	7 100	10 000	40.1	8.1	—	100	0.6
7015 A*	W	(M), T,TYN	DB DF DT	73 000	87 500	4 800	6 700	74.8	34.8	80	110	0.6
7015 C*	(M)	W,T, TYN	DB DF DT	78 000	91 500	6 700	9 500	45.4	5.4	—	110	0.6
7215 A*	W	(M), T,TYN	DB DF DT	123 000	129 000	4 300	6 000	84.2	34.2	81	124	1
7215 B	W	(M),T	DB DF DT	112 000	117 000	3 200	4 300	111.0	61.0	81	124	1
7215 BEA*	T85	MR	— — —	—	—	3 600	5 000	111.0	61.0	81	124	1
7215 C*	(M)	W,T,TYN,T7	DB DF DT	134 000	140 000	6 300	9 000	52.4	2.4	—	124	1
7315 A	W	(M), T	DB DF DT	221 000	212 000	3 000	4 000	104.8	30.8	82	153	1
7315 BEA	W	MR, T7	DB DF DT	217 000	197 000	2 200	3 000	135.6	61.6	82	153	1
7315BEA*	T85	MR	— — —	—	—	3 800	5 600	—	—	—	—	—
7916 A5*	(M)	T,TYN	DB DF DT	44 500	58 000	5 600	8 000	60.3	28.3	—	105	0.6
7916 C*	(M)	T, TYN	DB DF DT	47 000	61 500	6 700	9 500	41.5	9.5	—	105	0.6
7016 A*	W	(M), T,TYN	DB DF DT	89 500	106 000	4 300	6 000	81.2	37.2	85	120	0.6
7016 C*	(M)	W,T, TYN	DB DF DT	95 500	111 000	6 300	9 000	49.4	5.4	—	120	0.6
7216 A*	W	(M), T,TYN	DB DF DT	145 000	152 000	4 000	5 600	89.5	37.5	86	134	1
7216 B	W	(M),T	DB DF DT	131 000	139 000	2 800	4 000	118.3	66.3	86	134	1
7216 BEA*	T85	MR, T7	— — —	—	—	3 200	4 800	118.3	66.3	82	153	1
7216 C*	(M)	W,T,TYN	DB DF DT	151 000	155 000	6 000	8 000	55.5	3.5	—	134	1
7316 A	W	(M), T	DB DF DT	239 000	238 000	2 800	3 800	111.2	33.2	87	163	1
7316 BEA	W	MR, T7	DB DF DT	235 000	220 000	2 000	2 800	143.9	65.9	87	163	1
7316BEA*	T85	MR, T7, W	— — —	—	—	3 600	5 300	—	—	—	—	—

Note (⁴) (M) in the column of cage symbols are usually omitted from the bearing number.

Remark The bearings denoted by an asterisk (*) are NSKHPS Angular contact ball bearings and the column of Duplex in Bearing Numbers indicates the universal matching.

Angular Contact Ball Bearings

Single/matched mountings Bore Diameter 85 – 100 mm

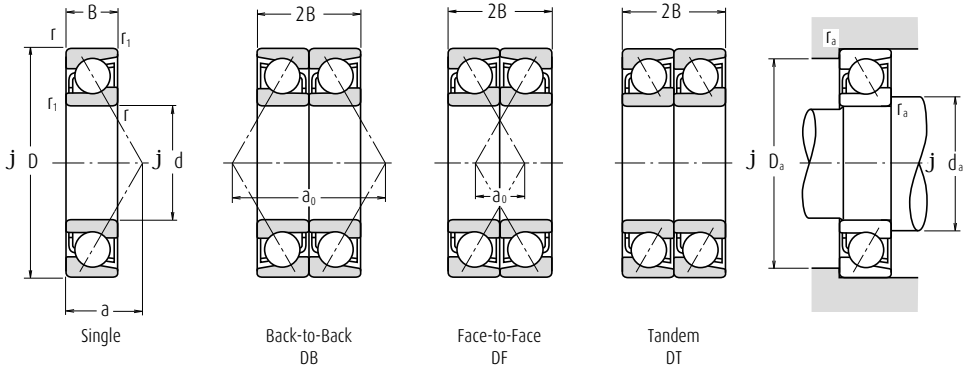

Boundary Dimensions (mm)					Basic Load Ratings (Single) (N)		Factor	Limiting Speeds (1) (min ⁻¹)		Eff. Load Centers (mm)	Abutment and Fillet Dimensions (mm)			Mass (kg)
d	D	B	r min.	r ₁ min.	C _r	C _{0r}		Grease	Oil	a	d _a min.	D _a max.	r _a max.	
85	120	18	1.1	0.6	38 500	38 500	—	9 800	14 700	32.9	92	113	1	0.541
	120	18	1.1	0.6	41 000	40 500	16.5	11 300	17 100	22.7	92	113	1	0.534
	130	22	1.1	0.6	57 500	53 500	—	7 000	9 400	42.0	92	123	1	0.913
	130	22	1.1	0.6	63 000	58 500	15.9	10 700	16 300	25.4	92	123	1	1.01
	150	28	2	1	104 000	83 500	—	6 400	8 600	47.9	95	140	2	1.83
	150	28	2	1	93 000	81 000	—	3 400	4 800	63.3	95	140	2	1.87
	150	28	2	1	113 000	90 500	14.7	9 800	14 900	29.7	95	140	2	2.04
	180	41	3	1.1	159 000	133 000	—	3 400	4 500	58.8	99	166	2.5	4.33
	180	41	3	1.1	146 000	122 000	—	3 000	4 000	76.1	99	166	2.5	4.42
	90	125	18	1.1	0.6	31 000	43 500	—	9 400	14 000	34.1	97	118	1
125		18	1.1	0.6	44 000	46 000	16.6	10 700	16 300	23.4	97	118	1	0.563
140		24	1.5	1	68 500	63 500	—	6 600	8 700	45.2	99	131	1.5	1.19
140		24	1.5	1	75 500	69 000	15.7	10 000	15 300	27.4	99	131	1.5	1.34
160		30	2	1	118 000	96 500	—	6 000	8 000	51.1	100	150	2	2.25
160		30	2	1	107 000	94 000	—	3 200	4 300	67.4	100	150	2	2.29
160		30	2	1	129 000	105 000	14.6	9 200	14 000	31.7	100	150	2	2.51
190		43	3	1.1	171 000	147 000	—	3 200	4 300	61.9	104	176	2.5	5.06
190		43	3	1.1	156 000	135 000	—	2 800	3 800	80.2	104	176	2.5	5.17
95		130	18	1.1	0.6	42 000	45 500	—	8 900	13 400	35.2	102	123	1
	130	18	1.1	0.6	44 500	48 000	16.7	10 300	15 600	24.1	102	123	1	0.591
	145	24	1.5	1	70 000	67 000	—	6 300	8 400	46.6	104	136	1.5	1.43
	145	24	1.5	1	77 000	73 000	15.9	9 600	14 600	28.1	104	136	1.5	1.42
	170	32	2.1	1.1	128 000	103 000	—	5 700	7 600	54.2	107	158	2	2.68
	170	32	2.1	1.1	116 000	101 000	—	3 000	4 000	71.6	107	158	2	2.74
	170	32	2.1	1.1	139 000	112 000	14.6	8 700	13 300	33.7	107	158	2	3.05
	200	45	3	1.1	183 000	162 000	—	3 000	4 000	65.1	109	186	2.5	5.83
	200	45	3	1.1	167 000	149 000	—	2 600	3 600	84.3	109	186	2.5	5.98
	100	140	20	1.1	0.6	49 500	51 500	—	8 400	12 500	38.0	107	133	1
140		20	1.1	0.6	52 500	54 000	16.5	9 600	14 600	26.1	107	133	1	0.794
150		24	1.5	1	72 000	70 500	—	6 000	8 000	48.1	109	141	1.5	1.48

- Notes**
- (1) For applications operating near the limiting speed, refer to Page B079.
 - (2) The suffixes A, A5, B, and C represent contact angles of 30°, 25°, 40°, and 15° respectively.
 - (3) For bearings marked — in the column for d₀, d_b and r_b for shafts are d_a (min.) and r_a (max.) respectively.

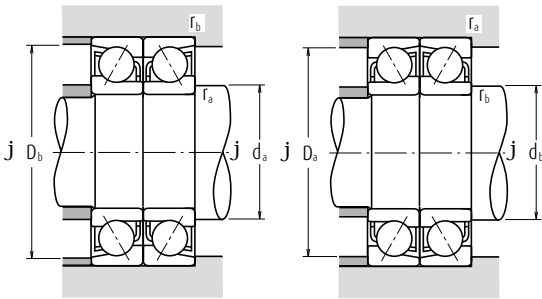

Dynamic Equivalent Load $P = X F_r + Y F_a$

Contact Angle	$i f_0 F_a^* / C_{or}$	e	Single, DT				DB or DF			
			$F_a/F_r \leq e$		$F_a/F_r > e$		$F_a/F_r \leq e$		$F_a/F_r > e$	
			X	Y	X	Y	X	Y	X	Y
15°	0.178	0.38	1	0	0.44	1.47	1	1.65	0.72	2.39
	0.357	0.40	1	0	0.44	1.40	1	1.57	0.72	2.28
	0.714	0.43	1	0	0.44	1.30	1	1.46	0.72	2.11
	1.07	0.46	1	0	0.44	1.23	1	1.38	0.72	2.00
	1.43	0.47	1	0	0.44	1.19	1	1.34	0.72	1.93
	2.14	0.50	1	0	0.44	1.12	1	1.26	0.72	1.82
	3.57	0.55	1	0	0.44	1.02	1	1.14	0.72	1.66
	5.35	0.56	1	0	0.44	1.00	1	1.12	0.72	1.63
25°	—	0.68	1	0	0.41	0.87	1	0.92	0.67	1.41
30°	—	0.80	1	0	0.39	0.76	1	0.78	0.63	1.24
40°	—	1.14	1	0	0.35	0.57	1	0.55	0.57	0.93

*For i, use 2 for DB, DF and 1 for DT

Static Equivalent Load $P_0 = X_0 F_r + Y_0 F_a$

Contact Angle	Single, DT		DB or DF		Single or DT mounting When $F_r > 0.5 F_r + Y_0 F_a$ use $P_0 = F_r$
	X_0	Y_0	X_0	Y_0	
15°	0.5	0.46	1	0.92	
25°	0.5	0.38	1	0.76	
30°	0.5	0.33	1	0.66	
40°	0.5	0.26	1	0.52	

Bearing Numbers (2) Cage Symbol (4)				Basic Load Ratings (Matched) (N)		Limiting Speeds (1) (Matched) (min ⁻¹)		Load Center Spacings (mm)		Abutment and Fillet Dimensions (mm)		
Single	Standard	Option	Duplex	C_r	C_{or}	Grease	Oil	DB	a_0 DF	d_b (2) min.	D_b max.	r_b (2) max.
7917 A5°	(M)	T, TYN	DB DF DT	59 500	77 000	5 300	7 500	65.8	29.8	—	115	0.6
7917 C°	(M)	T, TYN	DB DF DT	63 000	81 500	6 300	9 000	45.5	9.5	—	115	0.6
7017 A°	W	(M), T, TYN	DB DF DT	91 500	112 000	4 300	5 600	84.1	40.1	90	125	0.6
7017 C°	(M)	W, T, TYN	DB DF DT	98 000	117 000	6 000	8 500	50.8	6.8	—	125	0.6
7217 A°	W	(M), T, TYN	DB DF DT	167 000	178 000	3 800	5 300	95.8	39.8	91	144	1
7217 B	W	(M), T	DB DF DT	151 000	162 000	2 800	3 800	126.6	70.6	91	144	1
7217 C°	T85	—	—	174 000	181 000	5 600	7 500	59.5	3.5	—	144	1
7317 A	(M)	W, T, TYN	DB DF DT	258 000	265 000	2 600	3 600	117.5	35.5	92	173	1
7317 B	W	(M), T	DB DF DT	236 000	244 000	2 400	3 200	152.2	70.2	92	173	1
7918 A5°	W	(M), T	DB DF DT	64 000	87 000	5 000	7 100	68.1	32.1	—	120	0.6
7918 C°	T85	MR, 17	—	67 500	92 000	6 000	8 500	46.8	10.8	—	120	0.6
7018 A°	(M)	T, TYN	DB DF DT	109 000	133 000	3 800	5 300	90.4	42.4	96	134	1
7018 C°	(M)	T, TYN	DB DF DT	116 000	138 000	5 600	8 000	54.8	6.8	—	134	1
7218 A°	W	(M), T, TYN	DB DF DT	191 000	206 000	3 600	5 000	102.2	42.2	96	154	1
7218 B	(M)	W, T, TYN	DB DF DT	173 000	188 000	2 600	3 400	134.9	74.9	96	154	1
7218 C°	W	(M), T, TYN	DB DF DT	199 000	209 000	5 300	7 100	63.5	3.5	—	154	1
7318 A	W	(M), T	DB DF DT	277 000	294 000	2 600	3 400	123.8	37.8	97	183	1
7318 B	T85	MR	—	254 000	270 000	2 200	3 000	160.5	74.5	97	183	1
7919 A5°	(M)	W, T, TYN	DB DF DT	64 500	91 000	4 800	6 700	70.5	34.5	—	125	0.6
7919 C°	W	(M), T	DB DF DT	68 500	96 000	5 600	8 000	48.1	12.1	—	125	0.6
7019 A°	W	(M), T	DB DF DT	109 000	134 000	3 800	5 000	93.3	45.3	—	139	1
7019 C°	T85	MR	—	119 000	146 000	5 300	7 500	56.1	8.1	—	139	1
7219 A°	(M)	T, TYN	DB DF DT	208 000	221 000	3 400	4 500	108.5	44.5	102	163	1
7219 B	(M)	T, TYN	DB DF DT	188 000	202 000	2 400	3 200	143.2	79.2	102	163	1
7219 C°	(M)	T, TYN	DB DF DT	216 000	224 000	4 800	6 700	67.5	3.5	—	163	1
7319 A	(M)	T, TYN	DB DF DT	297 000	325 000	2 400	3 200	130.2	40.2	102	193	1
7319 B	W	(M), T, TYN	DB DF DT	272 000	298 000	2 200	3 000	168.7	78.7	102	193	1
7920 A5°	W	(M), T	DB DF DT	77 000	103 000	4 500	6 300	76.0	36.0	—	135	0.6
7920 C°	T85	MR, 17	—	81 500	108 000	5 300	7 500	52.2	12.2	—	135	0.6
7020 A°	(M)	W, T, TYN	DB DF DT	111 000	141 000	3 600	5 000	96.2	48.2	—	144	1

Note (4) (M) in the column of cage symbols are usually omitted from the bearing number.

Angular Contact Ball Bearings

Single/matched mountings Bore Diameter 100 – 120 mm

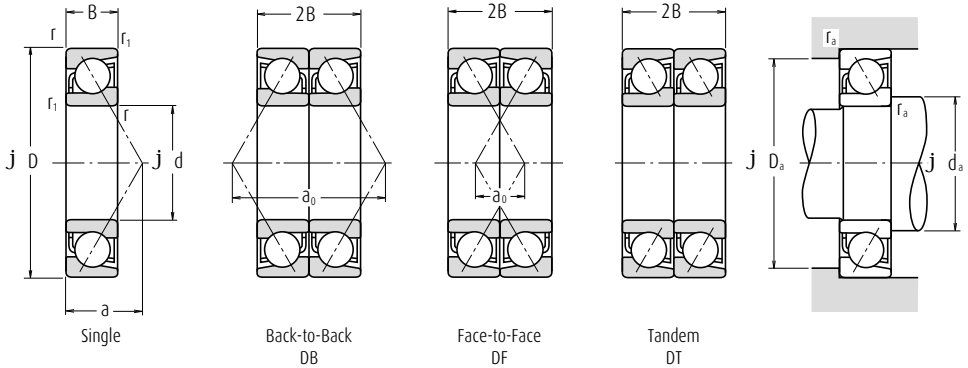

Boundary Dimensions (mm)	Basic Load Ratings (Single) (N)		Factor	Limiting Speeds (1) (min ⁻¹)		Eff. Load Centers (mm)	Abutment and Fillet Dimensions (mm)			Mass (kg)				
							d _a min.	D _a max.	r _a max.		approx.			
d	D	B	r min.	r ₁ min.	C _r	C _{0r}	f ₀	Grease	Oil	a	d _a min.	D _a max.	r _a max.	approx.
100	150	24	1.5	1	79 000	77 000	16.0	9 200	14 000	28.7	109	141	1.5	1.46
	180	34	2.1	1.1	144 000	117 000	—	5 400	7 200	57.4	112	168	2	3.22
	180	34	2.1	1.1	130 000	114 000	—	2 800	3 800	75.7	112	168	2	3.28
	180	34	2.1	1.1	157 000	127 000	14.5	8 300	12 500	35.7	112	168	2	3.65
	215	47	3	1.1	207 000	193 000	—	2 800	3 800	69.0	114	201	2.5	7.29
105	145	20	1.1	0.6	50 500	54 000	—	8 000	12 000	39.2	112	138	1	0.82
145	20	1.1	0.6	53 500	57 000	16.6	9 200	14 000	26.7	112	138	1	0.826	
160	26	2	1	84 000	81 500	—	5 700	7 600	51.2	115	150	2	1.84	
160	26	2	1	92 500	89 500	15.9	8 700	13 300	30.7	115	150	2	1.82	
190	36	2.1	1.1	157 000	132 000	—	5 100	6 800	60.6	117	178	2	3.84	
190	36	2.1	1.1	142 000	129 000	—	2 600	3 600	79.9	117	178	2	3.92	
190	36	2.1	1.1	171 000	143 000	14.5	7 800	11 900	37.7	117	178	2	4.33	
225	49	3	1.1	208 000	56 000	—	2 600	3 600	72.1	119	211	2.5	9.34	
225	49	3	1.1	191 000	59 500	—	2 400	3 200	93.7	119	211	2.5	9.43	
110	150	20	1.1	0.6	51 500	95 500	—	7 700	11 600	40.3	117	143	1	0.877
	150	20	1.1	0.6	54 500	104 000	16.7	8 900	13 500	27.4	117	143	1	0.867
	170	28	2	1	101 000	148 000	—	5 400	7 200	54.4	120	160	2	2.28
	170	28	2	1	111 000	144 000	15.6	8 300	12 500	32.7	120	160	2	2.26
	200	38	2.1	1.1	170 000	160 000	—	4 900	6 500	63.7	122	188	2	4.49
	200	38	2.1	1.1	154 000	144 000	—	2 600	3 400	84.0	122	188	2	4.58
	200	38	2.1	1.1	185 000	160 000	14.5	7 500	11 300	39.8	122	188	2	5.1
240	50	3	1.1	220 000	215 000	—	2 600	3 400	75.5	124	226	2.5	11.1	
240	50	3	1.1	201 000	197 000	—	2 200	3 000	98.4	124	226	2.5	11.2	
120	165	22	1.1	0.6	71 000	77 000	—	7 100	10 600	44.2	127	158	1	1.15
	165	22	1.1	0.6	75 500	81 000	16.5	8 100	12 300	30.1	127	158	1	1.15
	180	28	2	1	107 000	107 000	—	5 000	6 700	57.3	130	170	2	2.45
	215	40	2.1	1.1	192 000	177 000	—	4 500	6 000	68.3	132	203	2	6.22
	215	40	2.1	1.1	165 000	162 000	—	2 400	3 200	90.3	132	203	2	6.26
	260	55	3	1.1	246 000	252 000	—	2 200	3 000	82.3	134	246	2.5	14.5
260	55	3	1.1	225 000	231 000	—	2 000	2 800	107.2	134	246	2.5	14.4	

- Notes**
- (1) For applications operating near the limiting speed, refer to Page B079.
 - (2) The suffixes A, A5, B, and C represent contact angles of 30°, 25°, 40°, and 15° respectively.
 - (3) For bearings marked — in the column for d_b, d₀ and r₀ for shafts are d_a (min.) and r_a (max.) respectively.

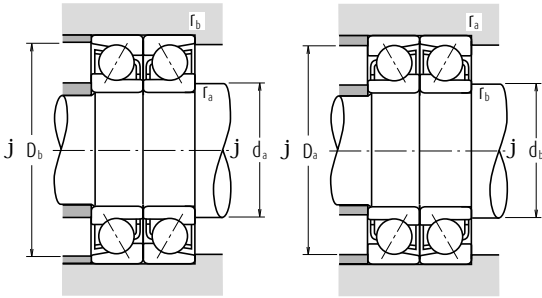

Dynamic Equivalent Load $P = X F_r + Y F_a$

Contact Angle	$\frac{i f_a F_a^*}{C_{or}}$	e	Single, DT				DB or DF			
			$F_a/F_r \leq e$		$F_a/F_r > e$		$F_a/F_r \leq e$		$F_a/F_r > e$	
			X	Y	X	Y	X	Y	X	Y
15°	0.178	0.38	1	0	0.44	1.47	1	1.65	0.72	2.39
	0.357	0.40	1	0	0.44	1.40	1	1.57	0.72	2.28
	0.714	0.43	1	0	0.44	1.30	1	1.46	0.72	2.11
	1.07	0.46	1	0	0.44	1.23	1	1.38	0.72	2.00
	1.43	0.47	1	0	0.44	1.19	1	1.34	0.72	1.93
	2.14	0.50	1	0	0.44	1.12	1	1.26	0.72	1.82
	3.57	0.55	1	0	0.44	1.02	1	1.14	0.72	1.66
25°	—	0.68	1	0	0.41	0.87	1	0.92	0.67	1.41
	—	0.80	1	0	0.39	0.76	1	0.78	0.63	1.24
	—	1.14	1	0	0.35	0.57	1	0.55	0.57	0.93

*For i, use 2 for DB, DF and 1 for DT

Static Equivalent Load $P_0 = X_0 F_r + Y_0 F_a$

Contact Angle	Single, DT		DB or DF		Single or DT mounting When $F_r > 0.5 F_r + Y_0 F_a$ use $P_0 = F_r$
	X_0	Y_0	X_0	Y_0	
15°	0.5	0.46	1	0.92	
25°	0.5	0.38	1	0.76	
30°	0.5	0.33	1	0.66	
40°	0.5	0.26	1	0.52	

Bearing Numbers (²) Cage Symbol (¹)				Basic Load Ratings (Matched) (N)		Limiting Speeds (¹) (Matched) (min⁻¹)		Load Center Spacings (mm)		Abutment and Fillet Dimensions (mm)		
Single	Standard	Option	Duplex	C_r	C_{or}	Grease	Oil	DB	a_0 DF	d_b (²) min.	D_b max.	r_b (²) max.
7020 C ^²	(M)	T, TYN	DB DF DT	122 000	154 000	5 300	7 100	57.5	9.5	—	144	1
7220 A ^²	W	(M), T, TYN	DB DF DT	233 000	251 000	3 200	4 300	114.8	46.8	107	173	1
7220 B	W	(M), T	DB DF DT	212 000	229 000	2 200	3 000	151.5	83.5	107	173	1
7220 C ^²	T85	MR	— — —	242 000	254 000	4 500	6 300	71.5	3.5	—	173	1
7320 A	(M)	W, T, TYN	DB DF DT	335 000	385 000	2 200	3 000	137.9	43.9	107	208	1
7320 B	W	(M), T	DB DF DT	310 000	355 000	2 000	2 800	179.2	85.2	107	208	1
7921 A5 [°]	W	(M), T	DB DF DT	78 500	108 000	4 300	6 000	78.3	38.3	—	140	0.6
7921 C ^²	T85	MR, T7	— — —	83 000	114 000	5 300	7 100	53.5	13.5	—	140	0.6
7021 A ^²	(M)	T, TYN	DB DF DT	130 000	163 000	3 400	4 500	102.5	50.5	—	154	1
7021 C ^²	(M)	T, TYN	DB DF DT	143 000	179 000	4 800	6 700	61.5	9.5	—	154	1
7221 A ^²	(M)	T, TYN	DB DF DT	254 000	283 000	3 000	4 000	121.2	49.2	112	183	1
7221 B	(M)	T, TYN	DB DF DT	231 000	258 000	2 200	3 000	159.8	87.8	112	183	1
7221 C ^²	W	(M), T	DB DF DT	264 000	286 000	4 300	6 000	75.5	3.5	—	183	1
7321 A	W	(M), T	DB DF DT	335 000	385 000	2 200	2 800	144.3	46.3	—	218	1
7321 B	T85	—	— — —	310 000	355 000	1 900	2 600	187.4	89.4	—	218	1
7922 A5 [°]	(M)	W, T, TYN	DB DF DT	79 500	112 000	4 300	5 600	80.6	40.6	—	145	0.6
7922 C ^²	(M)	T	DB DF DT	84 500	119 000	5 000	6 700	54.8	14.8	—	145	0.6
7022 A ^²	(M)	T	DB DF DT	157 000	191 000	3 200	4 300	108.8	52.8	—	164	1
7022 C ^²	T85	T7	— — —	172 000	208 000	4 500	6 300	65.5	9.5	—	164	1
7222 A ^²	(M)	T, TYN	DB DF DT	276 000	315 000	2 800	4 000	127.5	51.5	117	193	1
7222 B	(M)	T, TYN	DB DF DT	250 000	289 000	2 000	2 800	168.1	92.1	117	193	1
7222 C ^²	(M)	T, TYN	DB DF DT	286 000	320 000	4 000	5 600	79.5	3.5	—	193	1
7322 A	(M)	T, TYN	DB DF DT	360 000	430 000	2 000	2 600	151.0	51.0	—	233	1
7322 B	W	(M), T, TYN	DB DF DT	325 000	395 000	1 800	2 400	196.8	96.8	—	233	1
7924 A5 [°]	W	(M), T	DB DF DT	110 000	154 000	3 800	5 300	88.5	44.5	—	160	0.6
7924 C ^²	T85	MR	— — —	117 000	162 000	4 500	6 300	60.2	16.2	—	160	0.6
7024 A ^²	(M)	W, T, TYN	DB DF DT	166 000	213 000	3 000	4 000	114.6	58.6	—	174	1
7224 A ^²	(M)	W, T	DB DF DT	297 000	355 000	2 600	3 600	136.7	56.7	—	208	1
7224 B	(M)	W, T	DB DF DT	269 000	325 000	1 900	2 600	180.5	100.5	—	208	1
7324 A	T85	MR	— — —	400 000	505 000	1 800	2 400	164.7	54.7	—	253	1
7324 B	(M)	T, TYN	DB DF DT	365 000	460 000	1 600	2 200	214.4	104.4	—	253	1

Note (¹) (M) in the column of cage symbols are usually omitted from the bearing number.

Angular Contact Ball Bearings

Single/matched mountings Bore Diameter 130 – 170 mm

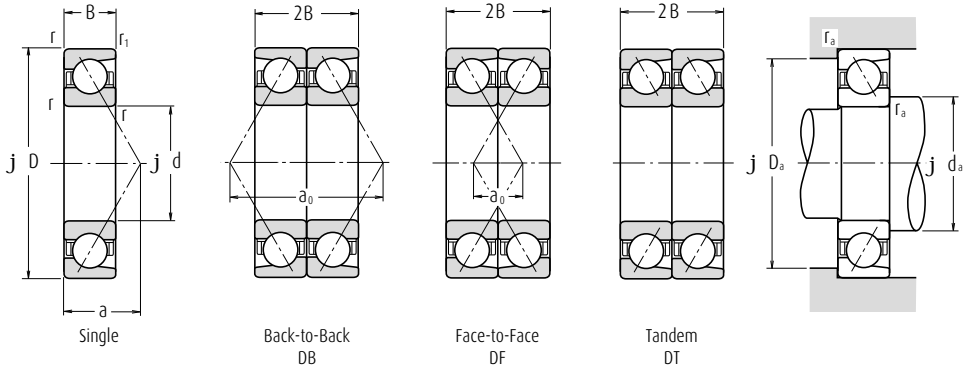

Boundary Dimensions (mm)					Basic Load Ratings (Single) (N)		Factor	Limiting Speeds (1) (min ⁻¹)		Eff. Load Centers (mm)	Abutment and Fillet Dimensions (mm)			Mass (kg)
d	D	B	r min.	r ₁ min.	C _r	C _{0r}	f ₀	Grease	Oil	a	d _s min.	D _s max.	r _s max.	approx.
130	180	24	1.5	1	78 000	86 000	—	6 500	9 700	48.1	139	171	1.5	1.54
	180	24	1.5	1	82 500	91 000	16.5	7 500	11 300	32.8	139	171	1.5	1.5
	200	33	2	1	123 000	125 000	—	4 600	6 100	64.1	140	190	2	3.68
	230	40	3	1.1	199 000	193 000	—	4 200	5 600	72.0	144	216	2.5	7.06
	230	40	3	1.1	171 000	175 000	—	2 200	3 000	95.5	144	216	2.5	7.1
	280	58	4	1.5	273 000	293 000	—	2 200	2 800	88.2	148	262	3	17.5
140	280	58	4	1.5	250 000	268 000	—	1 900	2 600	115.0	148	262	3	17.6
	190	24	1.5	1	78 500	90 000	—	6 100	9 100	50.5	149	181	1.5	1.63
	190	24	1.5	1	83 500	95 500	16.7	7 000	10 700	34.1	149	181	1.5	1.63
	210	33	2	1	126 000	133 000	—	4 300	5 800	67.0	150	200	2	3.9
	250	42	3	1.1	229 000	234 000	—	3 900	5 200	77.3	154	236	2.5	8.92
	250	42	3	1.1	197 000	213 000	—	2 000	2 800	102.8	154	236	2.5	8.94
150	300	62	4	1.5	300 000	335 000	—	2 000	2 600	94.5	158	282	3	21.4
	300	62	4	1.5	275 000	310 000	—	1 700	2 400	123.3	158	282	3	21.6
	210	28	2	1	101 000	115 000	—	5 600	8 400	56.0	160	200	2	2.97
	210	28	2	1	107 000	122 000	16.6	6 400	9 800	38.1	160	200	2	2.96
	225	35	2.1	1.1	144 000	154 000	—	4 000	5 400	71.6	162	213	2	4.75
	270	45	3	1.1	261 000	280 000	—	3 600	4 800	83.1	164	256	2.5	11.2
160	270	45	3	1.1	225 000	254 000	—	1 800	2 600	110.6	164	256	2.5	11.2
	320	65	4	1.5	315 000	370 000	—	1 800	2 400	100.3	168	302	3	26
	320	65	4	1.5	289 000	340 000	—	1 600	2 200	131.1	168	302	3	25.9
	220	28	2	1	112 000	133 000	16.7	3 600	4 800	39.4	170	210	2	3.1
	240	38	2.1	1.1	163 000	176 000	—	3 300	4 500	76.7	172	228	2	5.77
	290	48	3	1.1	263 000	305 000	—	1 900	2 600	89.0	174	276	2.5	14.1
170	290	48	3	1.1	238 000	279 000	—	1 700	2 400	118.4	174	276	2.5	14.2
	340	68	4	1.5	345 000	420 000	—	1 700	2 200	106.2	178	322	3	30.7
	340	68	4	1.5	315 000	385 000	—	1 500	2 000	138.9	178	322	3	30.8
	230	28	2	1	118 000	148 000	16.8	5 300	8 300	40.8	180	220	2	3.36
	260	42	2.1	1.1	195 000	214 000	—	3 100	4 200	83.1	182	248	2	7.9
	310	52	4	1.5	295 000	360 000	—	1 800	2 400	95.3	188	292	3	17.3
170	310	52	4	1.5	266 000	325 000	—	1 600	2 200	126.7	188	292	3	17.6
	360	72	4	1.5	390 000	485 000	—	1 600	2 200	112.5	188	342	3	35.8
	360	72	4	1.5	355 000	445 000	—	1 400	2 000	147.2	188	342	3	35.6

- Notes**
- (1) For applications operating near the limiting speed, refer to Page B079.
 - (2) The suffixes A, A5, B, and C represent contact angles of 30°, 25°, 40°, and 15° respectively.
 - (3) For bearings marked — in the column for d_b , d_0 and r_b for shafts are d_s (min.) and r_s (max.) respectively.

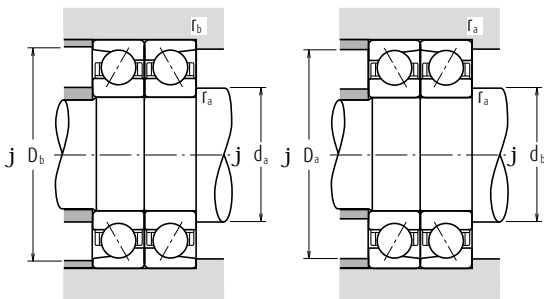

Dynamic Equivalent Load $P = X F_r + Y F_a$

Contact Angle	$\frac{i f_a F_a^*}{C_{or}}$	e	Single, DT				DB or DF			
			$F_a/F_r \leq e$		$F_a/F_r > e$		$F_a/F_r \leq e$		$F_a/F_r > e$	
			X	Y	X	Y	X	Y	X	Y
15°	0.178	0.38	1	0	0.44	1.47	1	1.65	0.72	2.39
	0.357	0.40	1	0	0.44	1.40	1	1.57	0.72	2.28
	0.714	0.43	1	0	0.44	1.30	1	1.46	0.72	2.11
	1.07	0.46	1	0	0.44	1.23	1	1.38	0.72	2.00
	1.43	0.47	1	0	0.44	1.19	1	1.34	0.72	1.93
	2.14	0.50	1	0	0.44	1.12	1	1.26	0.72	1.82
	3.57	0.55	1	0	0.44	1.02	1	1.14	0.72	1.66
	5.35	0.56	1	0	0.44	1.00	1	1.12	0.72	1.63
25°	—	0.68	1	0	0.41	0.87	1	0.92	0.67	1.41
30°	—	0.80	1	0	0.39	0.76	1	0.78	0.63	1.24
40°	—	1.14	1	0	0.35	0.57	1	0.55	0.57	0.93

*For i, use 2 for DB, DF and 1 for DT

Static Equivalent Load $P_0 = X_0 F_r + Y_0 F_a$

Contact Angle	Single, DT		DB or DF		Single or DT mounting When $F_r > 0.5 F_r + Y_0 F_a$ use $P_0 = F_r$
	X_0	Y_0	X_0	Y_0	
15°	0.5	0.46	1	0.92	
25°	0.5	0.38	1	0.76	
30°	0.5	0.33	1	0.66	
40°	0.5	0.26	1	0.52	

Bearing Numbers (²) Cage Symbol (⁴)				Basic Load Ratings (Matched) (N)		Limiting Speeds (¹) (Matched) (min⁻¹)		Load Center Spacings (mm)		Abutment and Fillet Dimensions (mm)		
Single	Standard	Option	Duplex	C_r	C_{or}	Grease	Oil	DB	a_0 DF	d_b (²) min.	D_b max.	r_b (²) max.
7926 A5 ^o	(M)	T, TYN	DB DF DT	120 000	172 000	3 400	4 800	96.3	48.3	—	174	1
7926 C ^o	(M)	T, TYN	DB DF DT	128 000	182 000	4 000	5 600	65.5	17.5	—	174	1
7026 A ^o	(M)	T, TYN	DB DF DT	191 000	251 000	2 600	3 600	128.3	62.3	—	194	1
7226 A ^o	(M)	T	DB DF DT	310 000	385 000	1 900	2 600	143.9	63.9	—	223	1
7226 B	(M)	T	DB DF DT	278 000	350 000	1 700	2 400	191.0	111.0	—	223	1
7326 A	(M)	T	DB DF DT	445 000	585 000	1 700	2 200	176.3	60.3	—	271	1.5
7326 B	(M)	T	DB DF DT	405 000	535 000	1 500	2 000	230.0	114.0	—	271	1.5
7928 A5 ^o	(M)	T, TYN	DB DF DT	122 000	180 000	3 200	4 500	100.9	52.9	—	184	1
7928 C ^o	(M)	T, TYN	DB DF DT	129 000	191 000	3 800	5 300	68.2	20.2	—	184	1
7028 A ^o	(M)	T	DB DF DT	194 000	265 000	2 600	3 400	134.0	68.0	—	204	1
7228 A ^o	(M)	T	DB DF DT	355 000	470 000	1 800	2 400	154.6	70.6	—	243	1
7228 B	(M)	T	DB DF DT	320 000	425 000	1 600	2 200	205.6	121.6	—	243	1
7328 A	(M)	T	DB DF DT	490 000	670 000	1 600	2 000	189.0	65.0	—	291	1.5
7328 B	(M)	T	DB DF DT	445 000	615 000	1 400	1 900	246.6	122.6	—	291	1.5
7930 A5 ^o	(M)	—	DB DF DT	157 000	231 000	3 000	4 000	112.0	56.0	—	204	1
7930 C ^o	(M)	—	DB DF DT	166 000	244 000	3 600	4 800	76.2	20.2	—	204	1
7030 A ^o	(M)	T	DB DF DT	222 000	305 000	1 900	2 400	143.3	73.3	—	218	1
7230 A ^o	(M)	—	DB DF DT	405 000	560 000	1 600	2 200	166.3	76.3	—	263	1
7230 B	(M)	T	DB DF DT	365 000	510 000	1 500	2 000	221.2	131.2	—	263	1
7330 A	(M)	—	DB DF DT	515 000	745 000	1 500	1 900	200.7	70.7	—	311	1.5
7330 B	(M)	T	DB DF DT	470 000	680 000	1 300	1 800	262.2	132.2	—	311	1.5
7932 C ^o	(M)	TYN	DB DF DT	173 000	265 000	3 000	4 000	78.9	22.9	—	214	1
7032 A ^o	(M)	T	DB DF DT	252 000	355 000	1 700	2 400	153.5	77.5	—	233	1
7232 A	(M)	T	DB DF DT	425 000	615 000	1 500	2 000	177.9	81.9	—	283	1
7232 B	(M)	—	DB DF DT	385 000	555 000	1 400	1 900	236.8	140.8	—	283	1
7332 A	(M)	T	DB DF DT	565 000	845 000	1 400	1 800	212.3	76.3	—	331	1.5
7332 B	(M)	T	DB DF DT	515 000	770 000	1 200	1 700	277.8	141.8	—	331	1.5
7934 C ^o	(M)	—	DB DF DT	183 000	297 000	2 800	3 800	81.6	25.6	—	224	1
7034 A ^o	(M)	—	DB DF DT	300 000	430 000	1 600	2 200	166.1	82.1	—	253	1
7234 A	(M)	—	DB DF DT	480 000	715 000	1 400	1 900	190.6	86.6	—	301	1.5
7234 B	(M)	—	DB DF DT	435 000	650 000	1 300	1 700	253.4	149.4	—	301	1.5
7334 A	(M)	—	DB DF DT	630 000	970 000	1 300	1 700	225.0	81.0	—	351	1.5
7334 B	(M)	T	DB DF DT	575 000	890 000	1 100	1 600	294.3	150.3	—	351	1.5

Note (⁴) (M) in the column of cage symbols are usually omitted from the bearing number.

Angular Contact Ball Bearings

Single/matched mountings Bore Diameter 180 – 200 mm

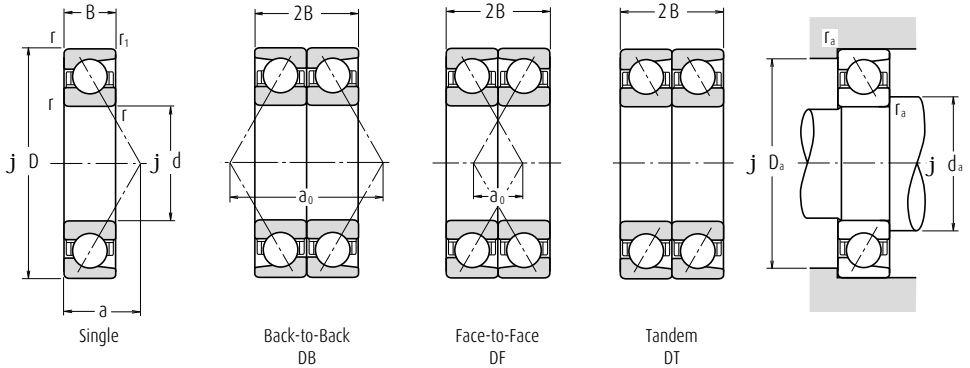

Boundary Dimensions (mm)					Basic Load Ratings (Single) (N)		Factor	Limiting Speeds (1) (min ⁻¹)		Eff. Load Centers (mm)	Abutment and Fillet Dimensions (mm)			Mass (kg)
d	D	B	r min.	r ₁ min.	C _r	C _{0r}	f ₀	Grease	Oil	a	d _a min.	D _a max.	r _a max.	approx.
180	250	33	2	1	152 000	184 000	16.6	4 900	7 700	45.3	190	240	2	4.9
	280	46	2.1	1.1	218 000	252 000	—	2 900	4 000	89.4	192	268	2	10.5
	320	52	4	1.5	305 000	385 000	—	1 700	2 200	98.2	198	302	3	18.1
	320	52	4	1.5	276 000	350 000	—	1 500	2 000	130.9	198	302	3	18.4
	380	75	4	1.5	410 000	535 000	—	1 500	2 000	118.3	198	362	3	42.1
380	75	4	1.5	375 000	490 000	—	1 300	1 800	155.0	198	362	3	42.6	
190	260	33	2	1	155 000	192 000	16.7	4 700	7 400	46.6	200	250	2	4.98
	290	46	2.1	1.1	235 000	280 000	—	2 800	3 800	92.3	202	278	2	11.3
	340	55	4	1.5	315 000	410 000	—	1 600	2 200	104.0	208	322	3	22.4
	340	55	4	1.5	284 000	375 000	—	1 400	2 000	138.7	208	322	3	22.5
	400	78	5	2	450 000	600 000	—	1 400	1 900	124.2	212	378	4	47.5
400	78	5	2	410 000	550 000	—	1 300	1 700	162.8	212	378	4	47.2	
200	280	38	2.1	1.1	199 000	244 000	16.5	4 400	6 900	51.2	212	268	2	6.85
	310	51	2.1	1.1	252 000	310 000	—	2 600	3 600	99.1	212	298	2	13.7
	360	58	4	1.5	335 000	450 000	—	1 500	2 000	109.8	218	342	3	26.5
	360	58	4	1.5	305 000	410 000	—	1 300	1 800	146.5	218	342	3	26.6
	420	80	5	2	475 000	660 000	—	1 300	1 800	129.5	222	398	4	54.4
420	80	5	2	430 000	600 000	—	1 200	1 600	170.1	222	398	4	55.3	

- Notes**
- (1) For applications operating near the limiting speed, refer to Page B079.
 - (2) The suffixes A, A5, B, and C represent contact angles of 30°, 25°, 40°, and 15° respectively.
 - (3) For bearings marked — in the column for d_b, d₀ and r₀ for shafts are d_a (min.) and r_a (max.) respectively.

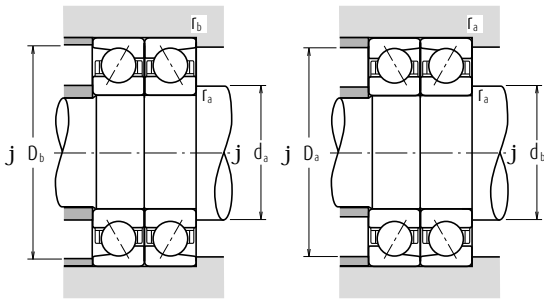

Dynamic Equivalent Load $P = X F_r + Y F_a$

Contact Angle	$i f_a F_a^*$ C_{or}	e	Single, DT				DB or DF			
			$F_a/F_r \leq e$		$F_a/F_r > e$		$F_a/F_r \leq e$		$F_a/F_r > e$	
			X	Y	X	Y	X	Y	X	Y
15°	0.178	0.38	1	0	0.44	1.47	1	1.65	0.72	2.39
	0.357	0.40	1	0	0.44	1.40	1	1.57	0.72	2.28
	0.714	0.43	1	0	0.44	1.30	1	1.46	0.72	2.11
	1.07	0.46	1	0	0.44	1.23	1	1.38	0.72	2.00
	1.43	0.47	1	0	0.44	1.19	1	1.34	0.72	1.93
	2.14	0.50	1	0	0.44	1.12	1	1.26	0.72	1.82
	3.57	0.55	1	0	0.44	1.02	1	1.14	0.72	1.66
	5.35	0.56	1	0	0.44	1.00	1	1.12	0.72	1.63
25°	—	0.68	1	0	0.41	0.87	1	0.92	0.67	1.41
30°	—	0.80	1	0	0.39	0.76	1	0.78	0.63	1.24
40°	—	1.14	1	0	0.35	0.57	1	0.55	0.57	0.93

*For i, use 2 for DB, DF and 1 for DT

Static Equivalent Load $P_0 = X_0 F_r + Y_0 F_a$

Contact Angle	Single, DT		DB or DF		Single or DT mounting When $F_r > 0.5 F_r + Y_0 F_a$ use $P_0 = F_r$
	X_0	Y_0	X_0	Y_0	
15°	0.5	0.46	1	0.92	
25°	0.5	0.38	1	0.76	
30°	0.5	0.33	1	0.66	
40°	0.5	0.26	1	0.52	

Bearing Numbers (²) Cage Symbol (⁴)				Basic Load Ratings (Matched) (N)		Limiting Speeds (¹) (Matched) (min⁻¹)		Load Center Spacings (mm)		Abutment and Fillet Dimensions (mm)		
Single	Standard	Option	Duplex	C_r	C_{or}	Grease	Oil	DB	a_0 DF	d_b (²) min.	D_b max.	r_b (²) max.
7936 C [⊖]	(M)	—	DB DF DT	236 000	370 000	2 600	3 600	90.6	24.6	—	244	1
7036 A [⊖]	(M)	—	DB DF DT	335 000	505 000	1 500	2 000	178.8	86.8	—	273	1
7236 A	(M)	—	DB DF DT	495 000	770 000	1 400	1 800	196.3	92.3	—	311	1.5
7236 B	(M)	—	DB DF DT	450 000	700 000	1 200	1 700	261.8	157.8	—	311	1.5
7336 A	(M)	—	DB DF DT	665 000	1 070 000	1 200	1 600	236.6	86.6	—	371	1.5
7336 B	(M)	—	DB DF DT	605 000	975 000	1 100	1 500	309.9	159.9	—	371	1.5
7938 C [⊖]	(M)	TYN	DB DF DT	239 000	385 000	2 400	3 400	93.3	27.3	—	254	1
7038 A [⊖]	(M)	—	DB DF DT	365 000	560 000	1 400	1 900	184.6	92.6	—	283	1
7238 A	(M)	—	DB DF DT	510 000	825 000	1 300	1 700	208.0	98.0	—	331	1.5
7238 B	(M)	—	DB DF DT	460 000	750 000	1 100	1 600	277.3	167.3	—	331	1.5
7338 A	(M)	T	DB DF DT	730 000	1 200 000	1 100	1 500	248.3	92.3	—	390	2
7338 B	(M)	—	DB DF DT	670 000	1 100 000	1 000	1 400	325.5	169.5	—	390	2
7940 C [⊖]	(M)	—	DB DF DT	305 000	490 000	2 200	3 200	102.3	26.3	—	273	1
7040 A [⊖]	(M)	T	DB DF DT	390 000	620 000	1 300	1 800	198.2	96.2	—	303	1
7240 A	(M)	—	DB DF DT	550 000	900 000	1 200	1 600	219.6	103.6	—	351	1.5
7240 B	(M)	—	DB DF DT	495 000	815 000	1 100	1 500	292.9	176.9	—	351	1.5
7340 A	(M)	T	DB DF DT	770 000	1 320 000	1 100	1 400	259.0	99.0	—	410	2
7340 B	(M)	—	DB DF DT	700 000	1 200 000	950	1 300	340.1	180.1	—	410	2

Note (⁴) (M) in the column of cage symbols are usually omitted from the bearing number.

Double-Row Angular Contact Ball Bearings

Bore Diameter 10 – 85 mm

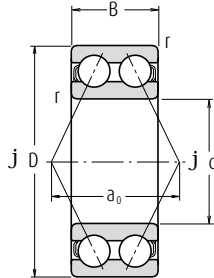

Boundary Dimensions (mm)				Basic Load Ratings (N)		Limiting Speeds (min ⁻¹)		
d	D	B	r min.	C _r	C _{0r}	Grease		Oil
						Open ZZ	DDU	Open
10	30	14,3	0,6	7 150	3 900	17 000	—	22 000
	30	14,3	0,6	7 150	3 900	17 000	15 000	—
12	32	15,9	0,6	10 500	5 800	15 000	—	20 000
	32	15,9	0,6	8 500	5 300	15 000	12 000	—
15	35	15,9	0,6	11 700	7 050	13 000	—	17 000
	35	15,9	0,6	8 500	5 300	13 000	12 000	—
	42	19	1	17 600	10 200	11 000	—	15 000
	42	19	1	14 700	9 100	11 000	10 000	—
17	40	17,5	0,6	14 600	9 050	11 000	—	15 000
	40	17,5	0,6	12 700	8 300	11 000	10 000	—
	47	22,2	1	21 000	12 600	10 000	—	13 000
	47	22,2	1	19 600	12 400	10 000	9 500	—
20	47	20,6	1	19 600	12 400	10 000	—	13 000
	47	20,6	1	15 900	10 700	10 000	9 000	—
	52	22,2	1,1	24 600	15 000	9 000	—	12 000
	52	22,2	1,1	19 700	12 800	9 000	8 500	—
25	52	20,6	1	21 300	14 700	8 500	—	11 000
	52	20,6	1	16 900	12 300	8 500	7 500	—
	62	25,4	1,1	32 500	20 700	7 500	—	10 000
	62	25,4	1,1	25 200	18 200	7 500	6 300	—
30	62	23,8	1	29 600	21 100	7 100	—	9 500
	62	23,8	1	25 200	18 200	7 100	6 300	—
	72	30,2	1,1	40 500	28 100	6 300	—	8 500
	72	30,2	1,1	39 000	28 700	6 300	5 300	—
35	72	27	1,1	39 000	28 700	6 300	—	8 000
	72	27	1,1	34 000	25 300	6 300	5 300	—
	80	34,9	1,5	51 000	36 000	5 600	—	7 500
	80	34,9	1,5	44 000	33 500	5 600	4 800	—
40	80	30,2	1,1	44 000	33 500	5 600	—	7 100
	80	30,2	1,1	36 500	29 000	5 600	4 800	—
	90	36,5	1,5	56 500	41 000	5 300	—	6 700
	90	36,5	1,5	49 500	38 000	5 300	4 500	—
45	85	30,2	1,1	49 500	38 000	5 000	—	6 700
	85	30,2	1,1	41 500	33 500	5 000	4 300	—
	100	39,7	1,5	68 500	51 000	4 500	—	6 000
	90	30,2	1,1	53 000	43 500	4 800	—	6 000
50	90	30,2	1,1	40 500	36 000	4 800	4 000	—
	110	44,4	2	81 500	61 500	4 300	—	5 600
	100	33,3	1,5	56 000	49 000	4 300	—	5 600
	100	33,3	1,5	49 500	43 500	4 300	3 600	—
60	120	49,2	2	95 000	73 000	3 800	—	5 000
	110	36,5	1,5	69 000	62 000	3 800	—	5 000
	130	54	2,1	125 000	98 500	3 400	—	4 500
65	120	38,1	1,5	76 500	69 000	3 600	—	4 500
	140	58,7	2,1	142 000	113 000	3 200	—	4 300
	70	125	39,7	94 000	82 000	3 400	—	4 500
75	150	63,5	2,1	159 000	128 000	3 000	—	3 800
	130	41,3	1,5	93 500	83 000	3 200	—	4 300
	80	140	44,4	99 000	93 000	3 000	—	3 800
85	150	49,2	2	116 000	110 000	2 800	—	3 600

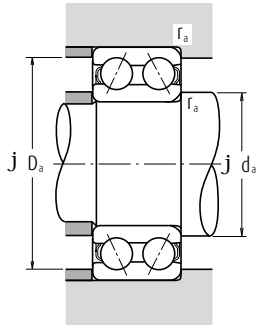

Dynamic Equivalent Load $P = X F_r + Y F_a$

$F_a/F_r \leq e$		$F_a/F_r > e$		e
X	Y	X	Y	
1	0.92	0.67	1.41	0.68

Static Equivalent Load $P_0 = F_r + 0.76 F_a$



Bearing Designations			Load Center Spacings (mm)	Abutment and Fillet Dimensions (mm)			Mass (kg)
Open	Shielded	Sealed	a_0	d_a min.	D_a max.	r_a max.	approx.
5200	—	—	14,5	15	25	0,6	0,050
—	5200ZZ	5200DDU	14,5	14	26	0,6	0,050
5201	—	—	16,7	17	27	0,6	0,060
—	5201BZZ	5201BDDU	16,3	16	28	0,6	0,060
5202	—	—	18,3	20	30	0,6	0,070
—	5202BZZ	5202BDDU	16,3	19	31	0,6	0,070
5302	—	—	22	21	36	1	0,13
—	5302AZZ	5302ADDU	21	21	36	1	0,13
5203	—	—	20,8	22	35	0,6	0,10
—	5203AZZ	5203ADDU	20,1	21	36	0,6	0,10
5303	—	—	25	23	41	1	0,18
—	5303AZZ	5303ADDU	24,3	23	41	1	0,18
5204	—	—	24,3	26	41	1	0,16
—	5204AZZ	5204ADDU	23	26	41	1	0,16
5304	—	—	26,7	27	45	1	0,22
—	5304AZZ	5304ADDU	25,4	27	45	1	0,22
5205	—	—	26,8	31	46	1	0,18
—	5205BZZ	5205BDDU	25,4	31	46	1	0,18
5305	—	—	31,8	32	55	1	0,35
—	5305AZZ	5305ADDU	30,9	32	55	1	0,36
5206	—	—	31,6	36	56	1	0,30
—	5206BZZ	5206BDDU	30,9	36	56	1	0,30
5306	—	—	36,5	37	65	1	0,57
—	5306AZZ	5306ADDU	36,6	37	65	1	0,57
5207	—	—	36,6	42	65	1	0,46
—	5207AZZ	5207ADDU	36,3	42	65	1	0,46
5307	—	—	41,6	44	71	1,5	0,76
—	5307AZZ	5307ADDU	41,5	44	71	1,5	0,79
5208	—	—	41,5	47	73	1	0,62
—	5208AZZ	5208ADDU	39,4	47	73	1	0,63
5308	—	—	45,5	49	81	1,5	1,03
—	5308AZZ	5308ADDU	43,8	49	81	1,5	1,05
5209	—	—	43,4	52	78	1	0,67
—	5209A1ZZ	5209A1DDU	42,5	52	78	1	0,67
5309	—	—	50,6	54	91	1,5	1,37
5210	—	—	45,9	57	83	1	0,72
—	5210AZZ	5210ADDU	44	57	83	1	0,73
5310	—	—	55,6	60	100	2	1,84
5211	—	—	50,1	64	91	1,5	1,01
—	5211AZZ	5211ADDU	49,2	64	91	1,5	1,01
5311	—	—	60,6	65	110	2	2,40
5212	—	—	56,5	69	101	1,5	1,33
5312	—	—	69,2	72	118	2	2,92
5213	—	—	59,7	74	111	1,5	1,71
5313	—	—	72,8	77	128	2	3,67
5214	—	—	63,8	79	116	1,5	1,75
5314	—	—	78,3	82	138	2	4,55
5215	—	—	66,1	84	121	1,5	1,88
5216	—	—	69,6	90	130	2	2,51
5217	—	—	75,3	95	140	2	3,16

Angular Contact Ball Bearings

Double Row | Bore 10–90 mm

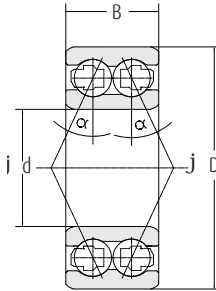

Open

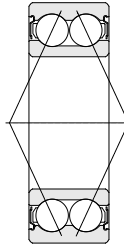

ZZR

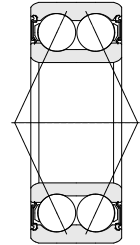

ZRSR

Dimensions				Abbreviation			Load ratings	
d	D	B	r _{1,2} min	Open	with shields ZZR	with seals ZRSR	dyn. C	stat. C ₀
mm							kN	
10	30	14.0	0.6	3200BTNG	..BZZRTNG	..BZRSRTNG	7.80	4.55
12	32	15.9	0.6	3201BTNG	..BZZRTNG	..BZRSRTNG	10.60	5.85
	37	19.0	1.0	3301BTNG	..BZZRTNG	..BZRSRTNG	14.50	8.20
15	35	15.9	0.6	3202BTNG	..BZZRTNG	..BZRSRTNG	11.80	7.10
	42	19.0	1.0	3302BTNG	..BZZRTNG	..BZRSRTNG	16.30	10.00
17	40	17.5	0.6	3203BTNG	..BZZRTNG	..BZRSRTNG	14.60	9.00
	47	22.2	1.0	3303BTNG	..BZZRTNG	..BZRSRTNG	20.80	12.50
20	47	20.6	1.0	3204BTNG	..BZZRTNG	..BZRSRTNG	19.60	12.50
	52	22.2	1.1	3304BTNG	..BZZRTNG	..BZRSRTNG	23.20	15.00
25	52	20.6	1.0	3205BTNG	..BZZRTNG	..BZRSRTNG	21.20	14.60
	62	25.4	1.1	3305BTNG	..BZZRTNG	..BZRSRTNG	30.00	20.00
30	62	23.8	1.0	3206BTNG	..BZZRTNG	..BZRSRTNG	30.00	21.20
	72	30.2	1.1	3306BTNG	..BZZRTNG	..BZRSRTNG	41.50	28.50
35	72	27.0	1.1	3207BTNG	..BZZRTNG	..BZRSRTNG	39.00	28.50
	80	34.9	1.5	3307BTNG	..BZZRTNG	..BZRSRTNG	51.00	34.50
40	80	30.2	1.1	3208BTNG	..BZZRTNG	..BZRSRTNG	48.00	36.50
	90	36.5	1.5	3308BTNG	..BZZRTNG	..BZRSRTNG	62.00	45.00
45	85	30.2	1.1	3209BTNG	..BZZRTNG	..BZRSRTNG	48.00	37.50
	100	39.7	1.5	3309BTNG	..BZZRTNG	..BZRSRTNG	68.00	51.00
50	90	30.2	1.1	3210BTNG	..BZZRTNG	..BZRSRTNG	51.00	42.50
	110	44.4	2.0	3310BTNG	..BZZRTNG	..BZRSRTNG	81.00	62.00
55	100	33.3	1.5	3211BTNG	..BZZRTNG	..BZRSRTNG	58.50	49.00
	120	49.2	2.0	3311BTNG	..BZZRTNG	..BZRSRTNG	102.00	78.00
60	110	36.5	1.5	3212BTNG	..BZZRTNG	..BZRSRTNG	72.00	61.00
	130	54.0	2.1	3312BTNG	..BZZRTNG	..BZRSRTNG	125.00	98.00
65	120	38.1	1.5	3213BTNG	..BZZRTNG	..BZRSRTNG	80.00	73.50
	140	58.7	2.1	3313BTNG	..BZZRTNG	..BZRSRTNG	150.00	118.00
70	125	39.7	1.5	3214BTNG	..BZZRTNG	..BZRSRTNG	83.00	76.50
	150	63.5	2.1	3314BTNG	..BZZRTNG	..BZRSRTNG	171.50	138.20
75	130	41.3	1.5	3215BTNG	..BZZRTNG	..BZRSRTNG	91.50	85.00
	160	68.3	2.1	3315BTNG	..BZZRTNG	..BZRSRTNG	173.40	145.30
80	140	44.4	2.0	3216BTNG	..BZZRTNG	..BZRSRTNG	98.00	93.00
85	150	49.2	2.0	3217BTNG	..BZZRTNG	..BZRSRTNG	116.00	110.00
90	160	52.4	2.0	3218BTNG	..BZZRTNG	..BZRSRTNG	124.60	120.30

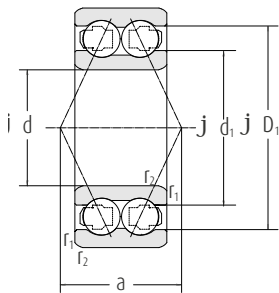

Open

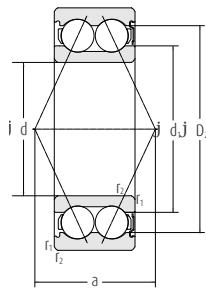

ZR, RSR

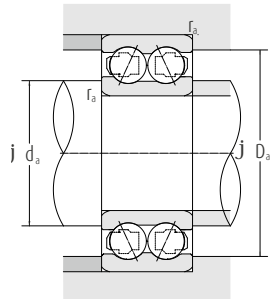

Speed limits		Dimensions (mm)			Abutment dimensions (mm)			Weight
Grease	Oil	d_1	D_1, D_2	a min	d_a max	D_a max	r_a max	kg
min^{-1}	min^{-1}							
16,000	22,000	17.9	23.9	15.1	15	25.0	0.6	0.043
15,000	20,000	18.3	25.7	16.6	17	27.0	0.6	0.051
10,500	11,500	21.1	30.4	19.4	19	32.0	1.0	0.090
14,000	19,000	21.0	29.3	18.0	20	30.0	0.6	0.058
11,000	16,000	25.6	34.2	21.2	21	36.0	1.0	0.112
12,000	17,000	24.0	33.1	20.5	22	35.0	0.6	0.085
10,000	15,000	26.2	37.7	24.0	23	41.0	1.0	0.161
10,000	15,000	28.9	38.7	24.2	26	41.0	1.0	0.139
9,000	13,000	31.2	42.6	26.4	27	45.0	1.0	0.197
8,500	12,000	33.9	43.7	26.5	31	46.0	1.0	0.159
7,500	10,000	37.1	50.0	30.7	32	55.0	1.0	0.316
7,000	9,500	40.0	52.7	31.4	36	56.0	1.0	0.265
6,300	8,500	44.0	59.0	36.2	37	65.0	1.0	0.496
6,300	8,500	47.2	60.4	36.6	42	65.0	1.0	0.412
5,600	7,500	49.2	65.4	41.5	44	71.0	1.5	0.664
5,600	7,500	52.9	67.9	40.9	47	73.0	1.0	0.550
5,000	6,700	55.4	74.3	46.1	49	81.0	1.5	0.905
5,000	6,700	57.1	72.6	43.2	52	78.0	1.0	0.583
4,500	6,000	62.2	81.6	50.0	54	91.0	1.5	1.210
4,800	6,300	61.9	78.1	45.5	57	83.0	1.0	0.632
4,000	5,300	68.2	89.6	54.9	60	100.0	2.0	1.600
4,300	5,600	68.6	85.3	49.9	64	91.0	1.5	0.876
3,800	5,000	75.2	98.4	61.2	65	110.0	2.0	2.110
3,800	5,000	75.7	94.3	55.1	69	101.0	1.5	1.180
3,400	4,500	81.2	108.7	67.3	72	118.0	2.0	2.700
3,400	4,500	84.5	103.5	59.8	74	111.0	1.5	1.520
3,200	4,300	88.2	118.0	73.3	77	128.0	2.0	3.390
3,400	4,500	86.7	106.2	61.6	79	116.0	1.5	1.640
3,000	4,000	94.7	125.0	80.8	84	135.0	2.1	4.900
3,200	4,300	92.4	112.6	65.0	89	116.6	1.5	1.910
2,800	3,800	101.4	133.0	83.8	90	143.0	2.1	5.700
3,000	4,000	98.5	120.3	69.0	91	129.0	2.0	2.450
2,800	3,800	106.4	128.5	74.6	100	135.0	2.0	3.300
2,600	3,600	113.2	136.6	78.9	109	141.0	2.1	4.170

Pulleys

Bore 10–35 mm

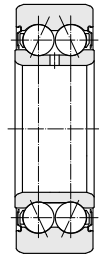

LZ..ZZR



LZ..ZRSR

d	Dimensions				Abbreviation for	
	D*	B	r, min	Shields	Seals	
	mm					
10	32	14.0	0.6	LZ3200BZZRSTNG	LZ3200B2RSRSTNG	
	32	14.0	0.6	LB3200BZZRSTNG	LB3200B2RSRSTNG	
12	35	15.9	0.6	LZ3201BZZRSTNG	LZ3201B2RSRSTNG	
	35	15.9	0.6	LB3201BZZRSTNG	LB3201B2RSRSTNG	
15	40	15.9	0.6	LZ3202BZZRSTNG	LZ3202B2RSRSTNG	
	40	15.9	0.6	LB3202BZZRSTNG	LB3202B2RSRSTNG	
17	47	17.5	0.6	LZ3203BZZRSTNG	LZ3203B2RSRSTNG	
	47	17.5	0.6	LB3203BZZRSTNG	LB3203B2RSRSTNG	
20	52	20.6	1.0	LZ3204BZZRSTNG	LZ3204B2RSRSTNG	
	52	20.6	1.0	LB3204BZZRSTNG	LB3204B2RSRSTNG	
25	62	20.6	1.0	LZ3205BZZRSTNG	LZ3205B2RSRSTNG	
	62	20.6	1.0	LB3205BZZRSTNG	LB3205B2RSRSTNG	
30	72	23.8	1.0	LZ3206BZZRSTNG	LZ3206B2RSRSTNG	
	72	23.8	1.0	LB3206BZZRSTNG	LB3206B2RSRSTNG	
35	80	27.0	1.0	LZ3207BZZRSTNG	LZ3207B2RSRSTNG	
	80	27.0	1.0	LB3207BZZRSTNG	LB3207B2RSRSTNG	

* with spherical outer ring D 0.05 mm

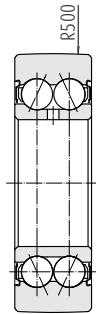

LB..2ZR

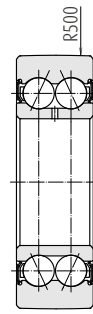

LB..2RSR



Bearing		Load ratings [kN]		Pulley	Speed limits	Weight
dyn. C	stat. C ₀	dyn. C	stat. C ₀		min ⁻¹	kg
7.8	4.55	7.45	4.15		16 000	0.061
7.8	4.55	7.45	4.15		16 000	0.061
10.6	5.85	9.95	5.20		15 000	0.079
10.6	5.85	9.95	5.20		15 000	0.079
11.8	7.10	11.00	6.45		13 000	0.100
11.8	7.10	11.00	6.45		13 000	0.100
14.6	9.00	13.80	8.30		10 000	0.165
14.6	9.00	13.80	8.30		10 000	0.165
19.6	12.50	18.30	11.00		9 000	0.210
19.6	12.50	18.30	11.00		9 000	0.210
21.2	14.60	19.90	13.40		8 000	0.330
21.2	14.60	19.90	13.40		8 000	0.330
30.0	21.20	27.90	18.60		7 100	0.500
30.0	21.20	27.90	18.60		7 100	0.500
39.0	28.50	36.20	25.0		6 300	0.660
39.0	28.50	36.20	25.0		6 300	0.660

Four-Point Contact Ball Bearings

Bore Diameter 30 – 95 mm

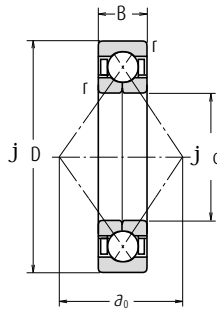

Boundary Dimensions (mm)				Basic Load Ratings (N)		Limiting Speeds (min ⁻¹)	
d	D	B	r min.	C _s	C _{0a}	Grease	Oil
30	62	16	1	31 000	45 000	8 500	12 000
	72	19	1.1	46 000	63 000	8 000	11 000
35	72	17	1.1	41 000	61 500	7 500	10 000
	80	21	1.5	55 000	80 000	7 100	9 500
40	80	18	1.1	49 000	77 500	6 700	9 000
	90	23	1.5	67 000	100 000	6 300	8 500
45	85	19	1.1	55 000	88 500	6 300	8 500
	100	25	1.5	87 500	133 000	5 600	7 500
50	90	20	1.1	57 000	97 000	5 600	8 000
	110	27	2	102 000	159 000	5 000	6 700
55	100	21	1.5	71 000	122 000	5 300	7 100
	120	29	2	118 000	187 000	4 500	6 300
60	110	22	1.5	85 500	150 000	4 800	6 300
	130	31	2.1	135 000	217 000	4 300	5 600
65	120	23	1.5	97 500	179 000	4 300	6 000
	140	33	2.1	153 000	250 000	3 800	5 300
70	125	24	1.5	106 000	197 000	4 000	5 600
	150	35	2.1	172 000	285 000	3 600	5 000
75	130	25	1.5	110 000	212 000	3 800	5 300
	160	37	2.1	187 000	320 000	3 400	4 800
80	125	22	1.1	77 000	167 000	3 800	5 300
	140	26	2	124 000	236 000	3 600	5 000
85	170	39	2.1	202 000	360 000	3 200	4 300
	130	22	1.1	79 000	176 000	3 800	5 000
90	150	28	2	143 000	276 000	3 400	4 800
	180	41	3	218 000	405 000	3 000	4 000
95	140	24	1.5	94 000	208 000	3 400	4 800
	160	30	2	164 000	320 000	3 200	4 300
95	190	43	3	235 000	450 000	2 800	3 800
	145	24	1.5	96 500	220 000	3 400	4 500
95	170	32	2.1	177 000	340 000	3 000	4 000
	200	45	3	251 000	495 000	2 600	3 600

Remark When using four-point contact ball bearings, please contact NSK.

Dynamic Equivalent Load $P_a = F_a$

Static Equivalent Load $P_{0a} = F_a$

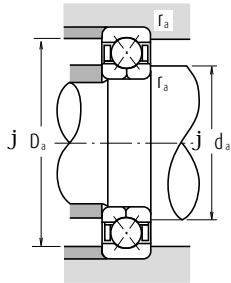

Bearing Numbers	Load Center Spacings (mm) a_0	Abutment and Fillet Dimensions (mm)			Mass (kg) approx.
		d_a min.	D_a max.	r_a max.	
QJ 206	32.2	36	56	1	0.24
QJ 306	35.7	37	65	1	0.42
QJ 207	37.5	42	65	1	0.35
QJ 307	40.3	44	71	1.5	0.57
QJ 208	42.0	47	73	1	0.45
QJ 308	45.5	49	81	1.5	0.78
QJ 209	45.5	52	78	1	0.52
QJ 309	50.8	54	91	1.5	1.05
QJ 210	49.0	57	83	1	0.59
QJ 310	56.0	60	100	2	1.35
QJ 211	54.3	64	91	1.5	0.77
QJ 311	61.3	65	110	2	1.75
QJ 212	59.5	69	101	1.5	0.98
QJ 312	66.5	72	118	2	2.15
QJ 213	64.8	74	111	1.5	1.2
QJ 313	71.8	77	128	2	2.7
QJ 214	68.3	79	116	1.5	1.3
QJ 314	77.0	82	138	2	3.18
QJ 215	71.8	84	121	1.5	1.5
QJ 315	82.3	87	148	2	3.9
QJ 1016	71.8	87	118	1	1.05
QJ 216	77.0	90	130	2	1.85
QJ 316	87.5	92	158	2	4.6
QJ 1017	75.3	92	123	1	1.1
QJ 217	82.3	95	140	2	2.2
QJ 317	92.8	99	166	2.5	5.34
QJ 1018	80.5	99	131	1.5	1.45
QJ 218	87.5	100	150	2	2.75
QJ 318	98.0	104	176	2.5	6.4
QJ 1019	84.0	104	136	1.5	1.5
QJ 219	92.8	107	158	2	3.35
QJ 319	103.3	109	186	2.5	7.4

Four-Point Contact Ball Bearings

Bore Diameter 100 – 200 mm

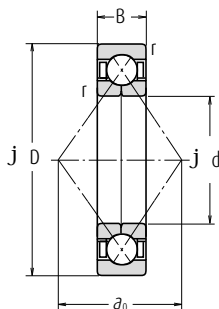

Boundary Dimensions (mm)				Basic Load Ratings (N)		Limiting Speeds (min ⁻¹)	
d	D	B	r min.	C _s	C _{0a}	Grease	Oil
100	150	24	1.5	98 500	232 000	3 200	4 300
	180	34	2.1	199 000	390 000	2 800	3 800
	215	47	3	300 000	640 000	2 400	3 400
105	160	26	2	115 000	269 000	3 000	4 000
	190	36	2.1	217 000	435 000	2 600	3 600
	225	49	3	305 000	640 000	2 400	3 200
110	170	28	2	139 000	315 000	2 800	3 800
	200	38	2.1	235 000	490 000	2 600	3 400
	240	50	3	320 000	710 000	2 200	3 000
120	180	28	2	147 000	350 000	2 600	3 600
	215	40	2.1	265 000	585 000	2 400	3 200
	260	55	3	360 000	835 000	2 000	2 800
130	200	33	2	169 000	415 000	2 400	3 200
	230	40	3	274 000	635 000	2 200	3 000
	280	58	4	400 000	970 000	1 900	2 600
140	210	33	2	172 000	435 000	2 200	3 000
	250	42	3	239 000	710 000	2 000	2 800
	300	62	4	440 000	1 110 000	1 700	2 400
150	225	35	2.1	197 000	505 000	2 000	2 800
	270	45	3	315 000	785 000	1 800	2 600
	320	65	4	460 000	1 230 000	1 600	2 200
160	240	38	2.1	224 000	580 000	1 900	2 600
	290	48	3	380 000	1 010 000	1 700	2 400
	340	68	4	505 000	1 400 000	1 500	2 000
170	260	42	2.1	268 000	705 000	1 800	2 400
	310	52	4	425 000	1 180 000	1 600	2 200
	360	72	4	565 000	1 610 000	1 400	2 000
180	280	46	2.1	299 000	830 000	1 700	2 200
	320	52	4	440 000	1 270 000	1 500	2 000
	380	75	4	595 000	1 770 000	1 300	1 800
190	290	46	2.1	325 000	925 000	1 600	2 200
	340	55	4	440 000	1 290 000	1 400	2 000
	400	78	5	655 000	1 980 000	1 300	1 700
200	310	51	2.1	345 000	1 020 000	1 500	2 000
	360	58	4	490 000	1 480 000	1 300	1 800
	420	80	5	690 000	2 180 000	1 200	1 600

Remark When using four-point contact ball bearings, please contact NSK.

Dynamic Equivalent Load $P_a = F_a$

Static Equivalent Load $P_{0a} = F_a$

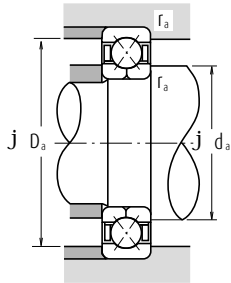

Bearing Numbers	Load Center Spacings (mm) a_0	Abutment and Fillet Dimensions (mm)			Mass (kg) approx.
		d_a min.	D_a max.	r_a max.	
QJ 1020	87.5	109	141	1.5	1.6
QJ 220	98.0	112	168	2	4.0
QJ 320	110.3	114	201	2.5	9.3
QJ 1021	92.8	115	150	2	2.0
QJ 221	103.3	117	178	2	4.7
QJ 321	115.5	119	211	2.5	10.5
QJ 1022	98.0	120	160	2	2.5
QJ 222	108.5	122	188	2	5.6
QJ 322	122.5	124	226	2.5	12.5
QJ 1024	105.0	130	170	2	2.65
QJ 224	117.3	132	203	2	6.9
QJ 324	133.0	134	246	2.5	15.4
QJ 1026	115.5	140	190	2	4.0
QJ 226	126.0	144	216	2.5	7.7
QJ 326	143.5	148	262	3	19
QJ 1028	122.5	150	200	2	4.3
QJ 228	136.5	154	236	2.5	9.8
QJ 328	154.0	158	282	3	24
QJ 1030	131.3	162	213	2	5.2
QJ 230	147.0	164	256	2.5	12
QJ 330	164.5	168	302	3	29
QJ 1032	140.0	172	228	2	6.4
QJ 232	157.5	174	276	2.5	15
QJ 332	175.1	178	322	3	31
QJ 1034	150.5	182	248	2	8.6
QJ 234	168.0	188	292	3	19.5
QJ 334	185.6	188	342	3	41
QJ 1036	161.0	192	268	2	11
QJ 236	175.1	198	302	3	20.5
QJ 336	196.1	198	362	3	48
QJ 1038	168.0	202	278	2	11.5
QJ 238	185.6	208	322	3	23
QJ 338	206.6	212	378	4	54.5
QJ 1040	178.6	212	298	2	15
QJ 240	196.1	218	342	3	27
QJ 340	217.1	222	398	4	61.5

Self-Aligning Ball Bearings



4. SELF-ALIGNING BALL BEARINGS

Introduction.....	Page B 120
-------------------	---------------

BEARINGS TABLE

SELF-ALIGNING BALL BEARINGS

Bore Dia.	Page
5 - 110 mm.....	B 122



Self-Aligning Ball Bearings

DESIGN, TYPES, AND FEATURES

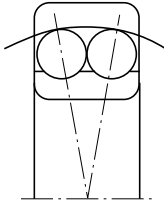

The outer ring has a spherical raceway and its center of curvature coincides with that of the bearing; therefore, the axis of the inner ring, balls and cage can deflect to some extent around the bearing center. This type is recommended when the alignment of the shaft and housing is difficult and when the shaft may bend. Since the contact angle is small, the axial load capacity is low.

Pressed steel cages are usually used.

PROTRUSION AMOUNT OF BALLS

Among self-aligning ball bearings, there are some in which the balls protrude from the side face as shown below. This protrusion amount b_1 is listed in the following table.

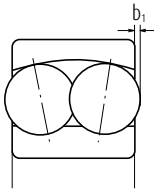

Bearing No.	b_1 (mm)
2222(K), 2316(K)	0.5
2319(K), 2320(K) 2321, 2322(K)	0.5
1318(K)	1.5
1319(K)	2
1320(K), 1321 1322(K)	3

	Tables	Pages
Tolerances and Running Accuracy	7.2	A128 to A131
Recommended Fits	8.3	A164
	8.5	A165
Internal Clearance	8.13	A170

PERMISSIBLE MISALIGNMENT

The permissible misalignment of self-aligning ball bearings is approximately 0.07 to 0.12 radian (4° to 7°) under normal loads. However, depending on the surrounding structure, such an angle may not be possible. Use care in the structural design.

CAGES

The cages of these bearings are made of pressed steel of glass-fibre reinforced Polyamid 66. Suffix

- (blank) - pressed steel
- J - pressed steel
- TN/TNG - Polyamide 66

SEALS

NSK manufactures Series 22.. and 23.. Self Aligning Ball Bearings, not only as an open version but also with seals on both sides of the bearing. These seals are made of nitrile rubber and are reinforced with a steel disc embedded in the rubber. The seals are fixed in the outer ring and seal against the inner ring with a friction sealing lip. Sealed Self Aligning Ball Bearings are filled with enough grease at the factory to last the normal life span of the bearing. The bearings are therefore maintenance free. Note that sealed Self Aligning Bearings have a lower load-carrying capacity than open bearings of the same type. During installation, it is essential that they are not twisted, as otherwise the seals may be forced out of position.

ANGLE ADJUSTMENT FACILITY

Self Aligning Bearings facilitate angle adjustment. The permitted angle of tilt from the central position for Series 12.. and 22.. open bearings is 2.5° and for Series 13.. and 23.. is 3°. With sealed bearings, the permitted angle of tilt is 1.5°.

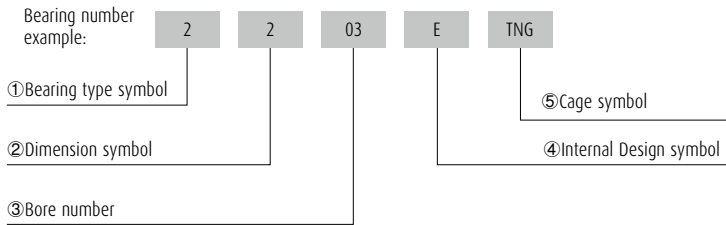

① Self Aligning Ball Bearing

② 1: series, 2: 2 series

③ Less than 03, Bearing bore 00 : 10 mm, 01 : 12 mm,

02 : 15 mm, 03 : 17 mm

Over 04, Bearing bore Bore number ×5 (mm)

④ E: High Load Capacity

⑤ (blank)/: Pressed Steel Cage

TN/TNG Polyamide Cage

Self-Aligning Ball Bearings

Bore Diameter 5 – 17 mm

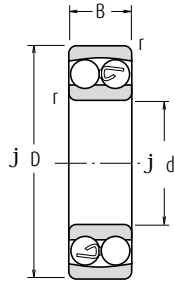

Cylindrical Bore

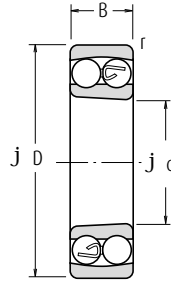

Tapered Bore

Boundary Dimensions (mm)				Basic Load Ratings (N)		Limiting Speeds (min ⁻¹)		Bearing
d	D	B	r min.	C _r	C _{0r}	Grease	Oil	Cylindrical Bore
5	19	6	0.3	2 530	475	30 000	36 000	135
6	19	6	0.3	2 530	475	30 000	36 000	126
7	22	7	0.3	2 750	600	26 000	32 000	127
8	22	7	0.3	2 750	600	26 000	32 000	108
9	26	8	0.6	4 150	895	26 000	30 000	129
10	30	9	0.6	5 550	1 190	22 000	28 000	1200
	30	9	0.6	5 500	1 530	24 000	30 000	1200TN
30	14	0.6	7 450	1 590	24 000	28 000	2200	
	14	0.6	7 200	2 040	24 000	30 000	2200TN	
35	11	0.6	7 350	1 620	20 000	24 000	1300	
	17	0.6	9 200	2 010	18 000	22 000	2300	
12	32	10	0.6	5 700	1 270	22 000	26 000	1201
	32	10	0.6	5 600	1 270	24 000	30 000	1201TNG
32	14	0.6	7 750	1 730	22 000	26 000	2201	
	14	0.6	9 000	1 960	20 000	26 000	2201ETNG	
37	12	1.0	9 650	2 160	18 000	22 000	1301	
	12	1.0	9 500	2 160	18 000	22 000	1301TN	
37	17	1.0	12 100	2 730	17 000	22 000	2301	
	11	0.6	7 600	1 750	18 000	22 000	1202	
15	35	11	0.6	7 500	1 760	20 000	26 000	1202TNG
	14	0.6	7 800	1 850	18 000	22 000	2202	
35	14	0.6	9 150	2 080	19 000	24 000	2202ETNG	
	13	1.0	9 700	2 290	16 000	20 000	1302	
42	13	1.0	9 500	2 280	17 000	20 000	1302TN	
	17	1.0	12 300	2 910	14 000	18 000	2302	
42	17	1.0	12 000	2 900	16 000	19 000	2302ETNG	
	12	0.6	8 000	2 010	16 000	20 000	1203	
40	12	0.6	8 000	2 040	18 000	22 000	1203TNG	
	16	0.6	9 950	2 420	16 000	20 000	2203	
40	16	0.6	11 400	2 750	16 000	19 000	2203ETNG	
	14	1.0	12 700	3 200	14 000	17 000	1303	
47	14	1.0	12 500	3 200	15 000	18 000	1303TN	
	19	1.0	14 700	3 550	13 000	16 000	2303	
47	19	1.0	14 300	3 550	14 000	17 000	2303TN	

Note (1) The suffix K represents bearings with tapered bores (1 : 12)

Remark For the dimensions related to adapters, refer to Page B376.

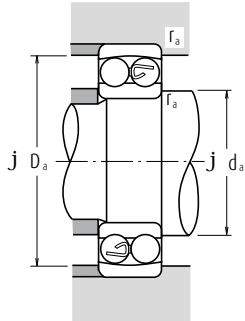

Dynamic Equivalent Load $P = X F_r + Y F_a$

$F_a/F_r \leq e$		$F_a/F_r > e$	
X	Y	X	Y
1	Y_3	0.65	Y_2

Static Equivalent Load $P_0 = F_r + Y_0 F_a$

The values of e , Y_2 , Y_3 , and Y_0 are listed in the table below.

Numbers Tapered Bore(1)	Abutment and Fillet Dimensions (mm)			Constant e	Axial Load Factors			Mass (kg) approx.
	d_a min.	D_a max.	r_a max.		Y_2	Y_3	Y_0	
—	7.0	17.0	0.3	0.34	2.9	1.9	1.9	0.009
—	8.0	17.0	0.3	0.34	2.9	1.9	1.9	0.008
—	9.0	20.0	0.3	0.31	3.1	2.0	2.1	0.013
—	10.0	20.0	0.3	0.31	3.1	2.0	2.1	0.016
—	13.0	22.0	0.6	0.32	3.1	2.0	2.1	0.021
—	14.0	26.0	0.6	0.32	3.1	2.0	2.1	0.034
—	14.0	26.0	0.6	0.32	3.00	2.0	2.1	0.034
—	14.0	26.0	0.6	0.64	1.5	0.98	1.0	0.046
—	14.0	26.0	0.6	0.66	1.50	1.0	1.0	0.047
—	14.0	31.0	0.6	0.35	2.8	1.8	1.9	0.059
—	14.0	31.0	0.6	0.71	1.4	0.89	0.93	0.080
—	16.0	28.0	0.6	0.36	2.7	1.8	1.8	0.041
—	16.0	28.0	0.6	0.37	2.60	1.7	0.040	0.040
—	16.0	28.0	0.6	0.58	1.7	1.1	1.1	0.051
—	16.0	28.0	0.6	0.53	1.85	1.2	1.3	0.053
—	17.0	32.0	1.0	0.33	2.9	1.9	2.0	0.068
—	17.0	32.0	1.0	0.35	2.80	1.8	1.9	0.067
—	17.0	32.0	1.0	0.60	1.6	1.1	1.1	0.089
—	19.0	31.0	0.6	0.32	3.1	2.0	2.1	0.050
—	19.0	31.0	0.6	0.34	2.90	1.9	2.0	0.049
—	19.0	31.0	0.6	0.50	1.9	1.3	1.3	0.058
—	19.0	31.0	0.6	0.46	2.10	1.4	1.4	0.060
—	20.0	37.0	1.0	0.33	2.9	1.9	2.0	0.101
—	20.0	37.0	1.0	0.35	2.80	1.8	1.9	0.094
—	20.0	37.0	1.0	0.51	1.9	1.2	1.3	0.116
—	20.0	37.0	1.0	0.51	1.90	1.2	1.3	0.110
—	21.0	36.0	0.6	0.31	3.1	2.0	2.1	0.074
—	21.0	36.0	0.6	0.33	3.00	1.9	2.0	0.073
—	21.0	36.0	0.6	0.50	1.9	1.3	1.3	0.089
—	21.0	36.0	0.6	0.46	2.10	1.4	1.4	0.088
—	22.0	42.0	1.0	0.32	3.1	2.0	2.1	0.13
—	22.0	42.0	1.0	0.32	3.00	1.9	2.0	0.130
—	22.0	42.0	1.0	0.51	1.9	1.2	1.3	0.16
—	22.0	42.0	1.0	0.53	1.90	1.2	1.3	0.160

Self-Aligning Ball Bearings

Bore Diameter 20 – 35 mm

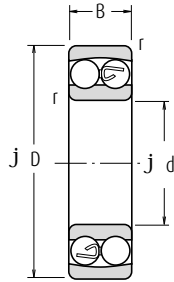

Cylindrical Bore

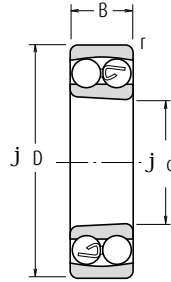

Tapered Bore

Boundary Dimensions (mm)				Basic Load Ratings (N)		Limiting Speeds (min ⁻¹)		Bearing	
d	D	B	r min.	C _r	C _{0r}	Grease	Oil	Cylindrical Bore	
20	47	14	1.0	10 000	2 610	14 000	17 000	1204	
	47	14	1.0	10 000	2 650	15 000	18 000	1204TNG	
	47	18	1.0	12 800	3 300	14 000	17 000	2204	
	47	18	1.0	14 300	3 550	14 000	17 000	2204ETNG	
	52	15	1.1	12 600	3 350	12 000	15 000	1304	
	52	15	1.1	12 500	3 350	13 000	16 000	1304TNG	
	52	21	1.1	18 500	4 700	11 000	14 000	2304	
	52	21	1.1	18 000	4 650	13 000	16 000	2304J	
	25	52	15	1.0	12 200	3 300	12 000	14 000	1205
		52	15	1.0	12 200	3 350	13 000	16 000	1205TNG
52		18	1.0	12 400	3 450	12 000	14 000	2205	
52		18	1.0	17 000	4 400	12 000	15 000	2205ETNG	
62		17	1.1	18 200	5 000	10 000	13 000	1305	
62		17	1.1	18 000	5 000	11 000	14 000	1305TNG	
62		24	1.1	24 900	6 600	9 500	12 000	2305	
62		24	1.1	24 500	6 550	10 000	13 000	2305TNG	
30	62	16	1.0	15 800	4 650	10 000	12 000	1206	
	62	16	1.0	15 600	4 650	11 000	14 000	1206TNG	
	62	20	1.0	15 300	4 550	10 000	12 000	2206	
	62	20	1.0	25 500	6 950	9 500	12 000	2206ETNG	
	72	19	1.1	21 400	6 300	8 500	11 000	1306	
	72	19	1.1	21 200	6 300	9 000	11 000	1306TNG	
	72	27	1.1	32 000	8 750	8 000	10 000	2306	
	72	27	1.1	31 500	8 650	8 500	10 000	2306TNG	
	35	72	17	1.1	15 900	5 100	8 500	10 000	1207
		72	17	1.1	16 000	5 200	9 500	12 000	1207TNG
72		23	1.1	21 700	6 600	8 500	10 000	2207	
72		23	1.1	32 000	9 000	8 000	9 500	2207ETNG	
80		21	1.5	25 300	7 850	7 500	9 500	1307	
80		21	1.5	25 000	8 000	8 000	9 500	1307TNG	
80	31	1.5	40 000	11 300	7 100	9 000	2307		
80	31	1.5	39 000	11 200	7 500	9 000	2307TNG		

Note (1) The suffix K represents bearings with tapered bores (1 : 12)

Remark For the dimensions related to adapters, refer to Page B376, B377 and B378.

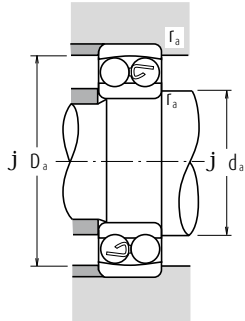

Dynamic Equivalent Load $P = X F_r + Y F_a$

$F_a/F_r \leq e$		$F_a/F_r > e$	
X	Y	X	Y
1	Y_3	0.65	Y_2

Static Equivalent Load $P_0 = F_r + Y_0 F_a$

The values of e , Y_2 , Y_3 , and Y_0 are listed in the table below.

Numbers Tapered Bore(!)	Abutment and Fillet Dimensions (mm)			Constant e	Axial Load Factors			Mass (kg) approx.
	d_a min.	D_a max.	r_a max.		Y_2	Y_3	Y_0	
1204 K	25.0	42.0	1.0	0.29	3.4	2.2	2.3	0.12
1204KTNG	25.0	42.0	1.0	0.28	3.50	2.2	2.3	0.120
2204 K	25.0	42.0	1.0	0.47	2.1	1.3	1.4	0.142
2204EKTNG	25.0	42.0	1.0	0.44	2.20	1.5	1.5	0.140
1304 K	26.5	45.5	1.0	0.29	3.4	2.2	2.3	0.164
1304KTNG	26.5	45.5	1.0	0.29	3.30	2.2	2.3	0.160
2304 K	26.5	45.5	1.0	0.50	1.9	1.2	1.3	0.210
2304KJ	26.5	45.5	1.0	0.51	1.90	1.2	1.3	0.210
1205 K	30.0	47.0	1.0	0.28	3.5	2.3	2.4	0.14
1205KTNG	30.0	47.0	1.0	0.27	3.70	2.4	2.5	0.140
2205 K	30.0	47.0	1.0	0.41	2.4	1.5	1.6	0.16
2205EKTNG	30.0	47.0	1.0	0.35	2.80	1.8	1.9	0.160
1305 K	31.5	55.5	1.0	0.28	3.5	2.3	2.4	0.261
1305KTNG	31.5	55.5	1.0	0.28	3.50	2.3	2.4	0.260
2305 K	31.5	55.5	1.0	0.47	2.1	1.4	1.4	0.340
2305EKTNG	31.5	55.5	1.0	0.48	2.00	1.3	1.4	0.340
1206 K	35.0	57.0	1.0	0.25	3.9	2.5	2.6	0.22
1206KTNG	35.0	57.0	1.0	0.25	3.90	2.5	2.7	0.220
2206 K	35.0	57.0	1.0	0.38	2.5	1.6	1.7	0.262
2206EKTNG	35.0	57.0	1.0	0.30	3.30	2.1	2.2	0.260
1306 K	36.5	65.5	1.0	0.26	3.7	2.4	2.5	0.391
1306KTNG	36.5	65.5	1.0	0.26	3.70	2.4	2.5	0.390
2306 K	36.5	65.5	1.0	0.44	2.2	1.4	1.5	0.51
2306KTNG	36.5	65.5	1.0	0.45	2.20	1.4	1.5	0.500
1207 K	41.5	65.5	1.0	0.23	4.2	2.7	2.8	0.33
1207KTNG	41.5	65.5	1.0	0.22	4.30	2.8	2.9	0.320
2207 K	41.5	65.5	1.0	0.37	2.6	1.7	1.8	0.403
2207EKTNG	41.5	65.5	1.0	0.30	3.30	2.1	2.2	0.400
1307 K	43.0	72.0	1.5	0.26	3.8	2.5	2.6	0.52
1307KTNG	43.0	72.0	1.5	0.26	3.80	2.5	2.6	0.510
2307 K	43.0	72.0	1.5	0.46	2.1	1.4	1.4	0.687
2307KTNG	43.0	72.0	1.5	0.47	2.10	1.4	1.4	0.680

Self-Aligning Ball Bearings

Bore Diameter 40 – 55 mm

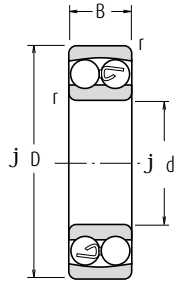

Cylindrical Bore

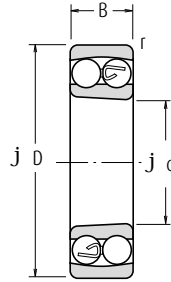

Tapered Bore

Boundary Dimensions (mm)				Basic Load Ratings (N)		Limiting Speeds (min ⁻¹)		Bearing
d	D	B	r min.	C _r	C _{0r}	Grease	Oil	Cylindrical Bore
40	80	18	1.1	19 300	6 500	7 500	9 000	1208
	80	18	1.1	19 300	6 550	8 500	10 000	1208TNG
	80	23	1.1	22 400	7 350	7 500	9 000	2208
	80	23	1.1	31 500	9 500	7 500	9 000	2208ETNG
	90	23	1.5	29 800	9 700	6 700	8 500	1308
	90	23	1.5	29 000	9 650	7 000	8 500	1308TNG
	90	33	1.5	45 500	13 500	6 300	8 000	2308
	90	33	1.5	45 000	13 400	6 700	8 000	2308TNG
	45	85	19	1.1	22 000	7 350	7 100	8 500
85		19	1.1	22 000	7 350	7 500	9 000	1209TNG
85		23	1.1	23 300	8 150	7 100	8 500	2209
85		23	1.1	28 000	9 000	7 000	8 500	2209ETNG
100		25	1.5	38 500	12 700	6 000	7 500	1309
100		25	1.5	38 000	12 900	6 300	7 500	1309TNG
50	100	36	1.5	55 000	16 700	5 600	7 100	2309
	100	36	1.5	54 000	16 300	6 000	7 000	2309TNG
	90	20	1.1	22 800	8 100	6 300	8 000	1210
		20	1.1	22 800	8 150	7 000	8 500	1210TNG
		23	1.1	23 300	8 450	6 300	8 000	2210
	90	23	1.1	28 000	9 500	6 700	8 000	2210ETNG
110	27	2.0	43 500	14 100	5 600	6 700	1310	
110	27	2.0	41 500	14 300	5 600	6 700	1310TNG	
55	110	40	2.0	65 000	20 200	5 000	6 300	2310
	110	40	2.0	64 000	20 000	5 300	6 300	2310TNG
	100	21	1.5	26 900	10 000	6 000	7 100	1211
		21	1.5	27 000	10 000	6 300	7 500	1211TNG
	100	25	1.5	26 700	9 900	6 000	7 100	2211
	100	25	1.5	39 000	12 700	5 600	6 700	2211ETNG
120	29	2.0	51 500	17 900	5 000	6 300	1311	
120	29	2.0	51 000	18 000	5 000	6 000	1311TNG	
120	43	2.0	76 500	24 000	4 800	6 000	2311	
120	43	2.0	75 000	23 600	4 800	5 600	2311TNG	

Notes (1) The suffix K represents bearings with tapered bores (1 : 12)

(2) The balls of the bearings marked * protrude slightly from the bearing face. The protrusion amounts are shown on Page B120.

Remark For the dimensions related to adapters, refer to Pages B378 and B379.

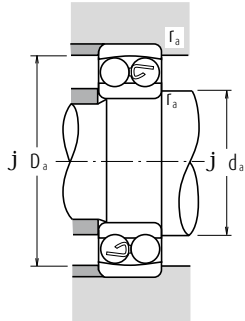

Dynamic Equivalent Load $P = X F_r + Y F_a$

$F_a/F_r \leq e$		$F_a/F_r > e$	
X	Y	X	Y
1	Y_3	0.65	Y_2

Static Equivalent Load $P_0 = F_r + Y_0 F_a$

The values of e , Y_2 , Y_3 , and Y_0 are listed in the table below.

Numbers Tapered Bore(!)	Abutment and Fillet Dimensions (mm)			Constant e	Axial Load Factors			Mass (kg) approx.
	d_a min.	D_a max.	r_a max.		Y_2	Y_3	Y_0	
1208 K	46.5	73.5	1.0	0.22	4.3	2.8	2.9	0.42
1208KTNG	46.5	73.5	1.0	0.22	4.5	2.9	3.0	0.420
2208 K	46.5	73.5	1.0	0.33	3.0	1.9	2.0	0.506
2208EKTNG	46.5	73.5	1.0	0.26	3.8	2.4	2.5	0.510
1308 K	48.0	82.0	1.5	0.24	4.0	2.6	2.7	0.727
1308KTNG	48.0	82.0	1.5	0.25	3.9	2.5	2.6	0.720
2308 K	48.0	82.0	1.5	0.43	2.3	1.5	1.5	0.940
2308KTNG	48.0	82.0	1.5	0.43	2.3	1.5	1.5	0.93
1209 K	51.5	78.5	1.0	0.21	4.7	3.0	3.1	0.47
1209KTNG	51.5	78.5	1.0	0.21	4.7	3.0	3.2	0.47
2209 K	51.5	78.5	1.0	0.30	3.2	2.1	2.2	0.556
2209EKTNG	51.5	78.5	1.0	0.26	3.8	2.4	2.5	0.55
1309 K	53.0	92.0	1.5	0.25	4.0	2.6	2.7	0.971
1309KTNG	53.0	92.0	1.5	0.25	3.9	2.5	2.6	0.96
2309 K	53.0	92.0	1.5	0.41	2.4	1.5	1.6	1.3
2309KTNG	53.0	92.0	1.5	0.43	2.3	1.5	1.6	1.25
1210 K	56.5	83.5	1.0	0.21	4.7	3.1	3.2	0.535
1210KTNG	56.5	83.5	1.0	0.19	4.9	3.2	3.3	0.53
2210 K	56.5	83.5	1.0	0.28	3.4	2.2	2.3	0.598
2210EKTNG	56.5	83.5	1.0	0.22	4.1	2.6	2.7	0.59
1310 K	59.0	101.0	2.0	0.23	4.2	2.7	2.8	1.23
1310KTNG	59.0	101.0	2.0	0.24	4.0	2.6	2.7	1.20
2310 K	59.0	101.0	2.0	0.42	2.3	1.5	1.6	1.66
2310KTNG	59.0	101.0	2.0	0.43	2.3	1.5	1.5	1.65
1211 K	63.0	92.0	1.5	0.20	4.9	3.2	3.3	0.708
1211KTNG	63.0	92.0	1.5	0.19	5.1	3.3	3.5	0.71
2211 K	63.0	92.0	1.5	0.28	3.5	2.3	2.4	0.807
2211EKTNG	63.0	92.0	1.5	0.22	4.5	2.9	2.1	0.81
1311 K	64.0	111.0	2.0	0.23	4.2	2.7	2.8	1.6
1311KTNG	64.0	111.0	2.0	0.24	4.1	2.7	2.8	1.60
2311 K	64.0	111.0	2.0	0.41	2.4	1.5	1.6	2.12
2311KTNG	64.0	111.0	2.0	0.42	2.3	1.5	1.6	2.10

Self-Aligning Ball Bearings

Bore Diameter 60 – 75 mm

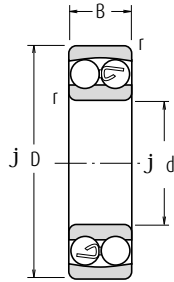

Cylindrical Bore

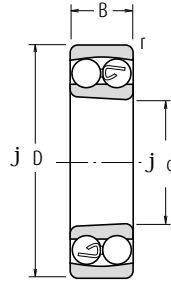

Tapered Bore

Boundary Dimensions (mm)				Basic Load Ratings (N)		Limiting Speeds (min ⁻¹)		Bearing	
d	D	B	r min.	C _r	C _{0r}	Grease	Oil	Cylindrical Bore	
60	110	22	1.5	30 500	11 500	5 300	6 300	1212	
	110	22	1.5	30 000	11 600	5 600	6 700	1212TNG	
	110	28	1.5	34 000	12 600	5 300	6 300	2212	
	110	28	1.5	47 500	16 600	5 300	6 300	2212ETNG	
	130	31	2.1	57 500	20 800	4 500	5 600	1312	
	130	31	2.0	57 500	20 800	4 800	5 600	1312TNG	
	130	46	2.1	88 500	28 300	4 300	5 300	2312	
	130	46	2.0	88 500	28 300	4 300	5 300	2312TNG	
	65	120	23	1.5	31 000	12 500	4 800	6 000	1213
		120	23	1.5	31 000	12 500	5 300	6 300	1213TNG
120		31	1.5	43 500	16 400	4 800	6 000	2213	
120		31	1.5	57 000	19 300	4 500	5 300	2213ETNG	
140		33	2.1	62 500	22 900	4 300	5 300	1313	
140		33	2.1	62 500	22 900	4 300	5 300	1313J	
140		48	2.1	97 000	32 500	3 800	4 800	2313	
140		48	2.1	96 500	32 500	4 000	4 800	2313J	
70	125	24	1.5	35 000	13 800	4 800	5 600	1214	
	125	24	1.5	34 500	13 700	5 000	6 000	1214TNG	
	125	31	1.5	44 000	17 100	4 500	5 600	2214	
	125	31	1.5	44 000	17 100	4 500	5 600	2214J	
	150	35	2.1	75 000	27 700	4 000	5 000	1314	
	150	35	2.1	67 500	25 100	4 000	5 000	1314J	
	150	51	2.1	111 000	37 500	3 600	4 500	2314	
	150	51	2.1	111 000	37 500	3 600	4 300	2314J	
75	130	25	1.5	39 000	15 700	4 300	5 300	1215	
	130	25	1.5	39 000	15 600	4 800	5 600	1215TNG	
	130	31	1.5	44 500	17 800	4 300	5 300	2215	
	130	31	1.5	44 500	17 800	4 300	5 300	2215J	
	160	37	2.1	80 000	30 000	3 800	4 500	1315	
	160	37	2.1	80 000	30 000	3 800	4 500	1315J	
	160	55	2.1	125 000	43 000	3 400	4 300	2315	
	160	55	2.1	125 000	43 000	3 400	4 300	2315J	

Notes (1) The suffix K represents bearings with tapered bores (1 : 12)

(2) The balls of the bearings marked * protrude slightly from the bearing face. The protrusion amounts are shown on Page B120.

Remark For the dimensions related to adapters, refer to Pages B378 and B379.

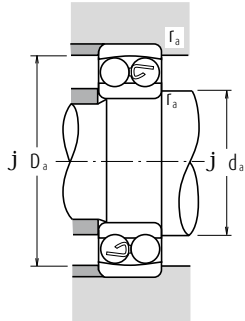

Dynamic Equivalent Load $P = X F_r + Y F_a$

$F_a/F_r \leq e$		$F_a/F_r > e$	
X	Y	X	Y
1	Y_3	0.65	Y_3

Static Equivalent Load $P_0 = F_r + Y_0 F_a$

The values of e , Y_2 , Y_3 , and Y_0 are listed in the table below.

Numbers Tapered Bore(!)	Abutment and Fillet Dimensions (mm)			Constant e	Axial Load Factors			Mass (kg) approx.
	d_a min.	D_a max.	r_a max.		Y_2	Y_3	Y_0	
1212 K	68.0	102.0	1.5	0.18	5.3	3.4	3.6	0.91
1212KTNG	68.5	101.5	1.5	0.18	5.4	3.5	3.6	0.90
2212 K	68.0	102.0	1.5	0.28	3.5	2.3	2.4	1.1
2212EKTNG	68.5	101.5	1.5	0.23	4.2	2.7	2.8	1.10
1312 K	71.0	119.0	2.0	0.23	4.3	2.8	2.9	2.0
1312KJ	72.0	118.0	2.0	0.23	4.3	2.8	2.9	1.95
2312 K	71.0	119.0	2.0	0.40	2.4	1.6	1.6	2.63
2312KJ	72.0	118.0	2.0	0.40	2.4	1.6	1.7	2.60
1213 K	73.0	112.0	1.5	0.17	5.7	3.7	3.8	1.16
1213KTNG	73.0	112.0	1.5	0.18	5.5	3.6	3.7	1.15
2213 K	73.0	112.0	1.5	0.28	3.5	2.3	2.4	1.5
2213EKTNG	73.0	112.0	1.5	0.23	4.3	2.8	2.9	1.45
1313 K	76.0	129.0	2.0	0.23	4.2	2.7	2.9	2.47
1313KTNG	76.0	128.0	2.0	0.23	4.3	2.8	2.9	2.45
2313 K	76.0	129.0	2.0	0.39	2.5	1.6	1.7	3.3
2313KTNG	76.0	128.0	2.0	0.39	2.5	1.6	1.7	3.25
—	78.0	117.0	1.5	0.18	5.3	3.4	3.6	1.3
—	78.0	116.5	1.5	0.19	5.1	3.3	3.5	1.25
—	78.0	117.0	1.5	0.26	3.7	2.4	2.5	1.55
—	78.0	116.5	1.5	0.26	3.7	2.4	2.5	1.50
—	81.0	139.0	2.0	0.22	4.4	2.8	3.0	3.03
—	81.0	138.0	2.0	0.22	4.4	2.8	3.0	3.00
—	81.0	139.0	2.0	0.38	2.6	1.7	1.8	4.0
—	81.0	138.0	2.0	0.38	2.6	1.7	1.8	4.25
1215 K	83.0	122.0	1.5	0.17	5.6	3.6	3.8	1.36
1215KTNG	83.5	121.5	1.5	0.17	5.6	3.6	3.8	1.35
2215 K	83.0	122.0	1.5	0.25	3.9	2.5	2.6	1.6
2215KJ	83.5	121.5	1.5	0.25	3.9	2.5	2.6	1.60
1315 K	86.0	149.0	2.0	0.22	4.4	2.8	2.9	3.63
1315KJ	87.0	148.0	2.0	0.22	4.4	2.8	3.0	3.55
2315 K	86.0	149.0	2.0	0.38	2.5	1.6	1.7	4.84
2315KJ	87.0	148.0	2.0	0.38	2.6	1.6	1.7	5.15

Self-Aligning Ball Bearings

Bore Diameter 80 – 110 mm

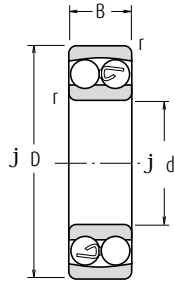

Cylindrical Bore

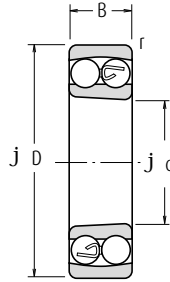

Tapered Bore

Boundary Dimensions (mm)				Basic Load Ratings (N)		Limiting Speeds (min ⁻¹)		Bearing
d	D	B	r min.	C _r	C _{0r}	Grease	Oil	Cylindrical Bore
80	140	26	2.0	40 000	17 000	4 000	5 000	1216
	140	33	2.0	49 000	19 900	4 000	5 000	2216
	170	39	2.1	89 000	33 000	3 600	4 300	1316
	170	58	2.1	130 000	45 000	3 200	4 000	* 2316
85	150	28	2.0	49 500	20 800	3 800	4 500	1217
	150	36	2.0	58 500	23 600	3 800	4 800	2217
	180	41	3.0	98 500	38 000	3 400	4 000	1317
	180	60	3.0	142 000	51 500	3 000	3 800	2317
90	160	30	2.0	57 500	23 500	3 600	4 300	1218
	160	40	2.0	70 500	28 700	3 600	4 300	2218
	190	43	3.0	117 000	44 500	3 200	3 800	* 1318
	190	64	3.0	154 000	57 500	2 800	3 600	2318
95	170	32	2.1	64 000	27 100	3 400	4 000	1219
	170	43	2.1	84 000	34 500	3 400	4 000	2219
	200	45	3.0	129 000	51 000	3 000	3 600	* 1319
	200	67	3.0	161 000	64 500	2 800	3 400	* 2319
100	180	34	2.1	69 500	29 700	3 200	3 800	1220
	180	46	2.1	94 500	38 500	3 200	3 800	2220
	215	47	3.0	140 000	57 500	2 800	3 400	* 1320
	215	73	3.0	187 000	79 000	2 400	3 200	* 2320
105	190	36	2.1	75 000	32 500	3 000	3 600	1221
	190	50	2.1	109 000	45 000	3 000	3 600	2221
	225	49	3.0	154 000	64 500	2 600	3 200	* 1321
	225	77	3.0	200 000	87 000	2 400	3 000	* 2321
110	200	38	2.1	87 000	38 500	2 800	3 400	1222
	200	53	2.1	122 000	51 500	2 800	3 400	* 2222
	240	50	3.0	161 000	72 000	2 400	3 000	* 1322
	240	80	3.0	211 000	94 500	2 200	2 800	* 2322

Notes (1) The suffix K represents bearings with tapered bores (1 : 12)

(2) The balls of the bearings marked * protrude slightly from the bearing face. The protrusion amounts are shown on Page B120.

Remark For the dimensions related to adapters, refer to Pages B378 and B379.

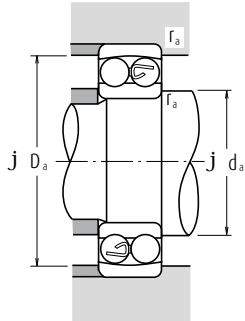

Dynamic Equivalent Load $P = XF_r + YF_a$

$F_a/F_r \leq e$		$F_a/F_r > e$	
X	Y	X	Y
1	Y_3	0.65	Y_3

Static Equivalent Load $P_0 = F_r + Y_0 F_a$

The values of e , Y_2 , Y_3 , and Y_0 are listed in the table below.

Numbers Tapered Bore(!)	Abutment and Fillet Dimensions (mm)			Constant e	Axial Load Factors			Mass (kg) approx.
	d_a min.	D_a max.	r_a max.		Y_2	Y_3	Y_0	
1216 K	89	131	2.0	0.16	6.0	3.9	4.1	1.68
2216 K	89	131	2.0	0.25	3.9	2.5	2.7	1.97
1316 K	91	159	2.0	0.22	4.5	2.9	3.1	4.24
* 2316 K	91	159	2.0	0.39	2.5	1.6	1.7	5.75
1217 K	94	141	2.0	0.17	5.7	3.7	3.8	2.1
2217 K	94	141	2.0	0.25	3.9	2.5	2.6	2.56
1317 K	98	167	2.5	0.21	4.6	2.9	3.1	5.03
2317 K	98	167	2.5	0.37	2.6	1.7	1.8	6.68
1218 K	99	151	2.0	0.17	5.8	3.8	3.9	2.56
2218 K	99	151	2.0	0.27	3.7	2.4	2.5	3.22
* 1318 K	103	177	2.5	0.22	4.3	2.8	2.9	5.83
2318 K	103	177	2.5	0.38	2.6	1.7	1.7	7.87
1219 K	106	159	2.0	0.17	5.8	3.7	3.9	3.12
2219 K	106	159	2.0	0.27	3.7	2.4	2.5	3.96
* 1319 K	108	187	2.5	0.23	4.3	2.8	2.9	6.79
* 2319 K	108	187	2.5	0.38	2.6	1.7	1.8	9.09
1220 K	111	169	2.0	0.17	5.6	3.6	3.8	3.82
2220 K	111	169	2.0	0.27	3.7	2.4	2.5	4.71
* 1320 K	113	202	2.5	0.24	4.1	2.7	2.8	8.4
* 2320 K	113	202	2.5	0.38	2.6	1.7	1.8	11.5
—	116	179	2.0	0.18	5.5	3.6	3.7	4.43
—	116	179	2.0	0.28	3.5	2.3	2.4	5.73
—	118	212	2.5	0.23	4.2	2.7	2.9	9.58
—	118	212	2.5	0.38	2.6	1.7	1.7	14.5
1222 K	121	189	2.0	0.17	5.7	3.7	3.9	5.21
* 2222 K	121	189	2.0	0.28	3.5	2.2	2.3	6.75
* 1322 K	123	227	2.5	0.22	4.4	2.8	3.0	11.5
* 2322 K	123	227	2.5	0.37	2.6	1.7	1.8	17.5

Self-Aligning Ball Bearings

With adapter sleeve | Shaft 17–65 mm

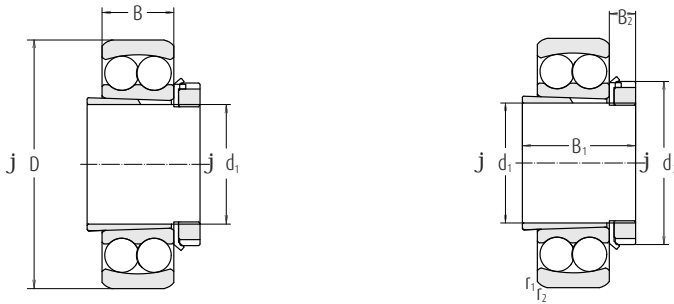

d ₁ Shaft	Dimensions			Load ratings		Speed limits		Abbreviation for	
	D	B	r _{1,2} min.	dyn. C	stat. C ₀	Grease	Oil	Bearing	Sleeve
	mm			kN		(min ⁻¹)			
17	47	14	1.0	10.00	2.65	15 000	18 000	1204KTNG	H204
	47	18	1.0	14.30	3.55	14 000	17 000	2204EKTNG	H304
	52	15	1.1	12.50	3.35	13 000	16 000	1304KTNG	H304
20	52	21	1.1	18.00	4.65	13 000	16 000	2304KJ	H2304
	52	15	1.0	12.20	3.35	13 000	16 000	1205KTNG	H205
	52	18	1.0	17.00	4.40	12 000	15 000	2205EKTNG	H305
25	62	17	1.1	18.00	5.00	11 000	14 000	1305KTNG	H305
	62	24	1.1	24.50	6.55	10 000	13 000	2305KTNG	H2305
	62	16	1.0	15.60	4.65	11 000	14 000	1206KTNG	H206
30	62	20	1.0	25.50	6.95	9 500	12 000	2206EKTNG	H306
	72	19	1.1	21.20	6.30	9 000	11 000	1306KTNG	H306
	72	27	1.1	31.50	8.65	8 500	10 000	2306KTNG	H2306
35	72	17	1.1	16.00	5.20	9 500	12 000	1207KTNG	H207
	72	23	1.1	32.00	9.00	8 000	9 500	2207EKTNG	H307
	80	21	1.5	25.00	8.00	8 000	9 500	1307KTNG	H307
40	80	31	1.5	39.00	11.20	7 500	9 000	2307KTNG	H2307
	80	18	1.1	19.30	6.55	8 500	10 000	1208KTNG	H208
	80	23	1.1	31.50	9.50	7 500	9 000	2208EKTNG	H308
45	90	23	1.5	29.00	9.65	7 000	8 500	1308KTNG	H308
	90	33	1.5	45.00	13.40	6 700	8 000	2308KTNG	H2308
	85	19	1.1	22.00	7.35	7 500	9 000	1209KTNG	H209
50	85	23	1.1	28.00	9.00	7 000	8 500	2209EKTNG	H309
	100	25	1.5	38.00	12.90	6 300	7 500	1309KTNG	H309
	100	36	1.5	54.00	16.30	6 000	7 000	2309KTNG	H2309
55	90	20	1.1	22.90	8.15	7 000	8 500	1210KTNG	H210
	90	23	1.1	28.00	9.50	6 700	8 000	2210EKTNG	H310
	110	27	2.0	41.50	14.30	5 600	6 700	1310KTNG	H310
60	110	40	2.0	64.00	20.00	5 300	6 300	2310KTNG	H2310
	100	21	1.5	27.00	10.00	6 300	7 500	1211KTNG	H211
	100	25	1.5	39.00	12.70	5 600	6 700	2211EKTNG	H311
65	120	29	2.0	51.00	18.00	5 000	6 000	1311KTNG	H311
	120	43	2.0	75.00	23.60	4 800	5 600	2311KTNG	H2311
	110	22	1.5	30.00	11.60	5 600	6 700	1212KTNG	H212
70	110	28	1.5	47.50	16.60	5 300	6 300	2212EKTNG	H312
	130	31	2.0	57.50	20.80	4 800	5 600	1312KJ	H312
	130	46	2.0	88.50	28.30	4 300	5 300	2312KJ	H2312
75	120	23	1.5	31.00	12.50	5 300	6 300	1213KTNG	H213
	120	31	1.5	57.00	19.30	4 500	5 300	2213EKTNG	H313
	140	33	2.1	62.50	22.90	4 300	5 300	1313KJ	H313
80	140	48	2.1	96.50	32.50	4 000	4 800	2313KJ	H2313
	130	25	1.5	39.00	15.60	4 800	5 600	1215KTNG	H215
	130	31	1.5	44.50	17.80	4 300	5 300	2215KJ	H315
85	160	37	2.1	80.00	30.00	3 800	4 500	1315KJ	H315
	160	55	2.1	125.00	43.00	3 400	4 300	2315KJ	H2315

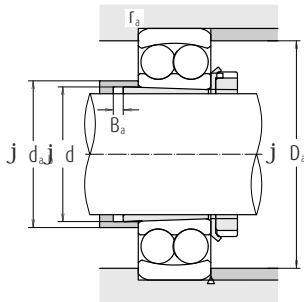

Dimensions (mm)			Abutment dimensions (mm)					Factors				Weight	
d_3	B_1	B_2	d_a max	d_b min	D_a max	B_a min	r_a max	e	Y_1 $F_a/fr \leq e$	Y_2 $F_a/fr > e$	Y_0	Bearing kg	Sleeve kg
32	24	7	27	23	42.0	5	1.0	0.28	2.2	3.5	2.3	0.12	0.041
32	28	7	27	23	42.0	5	1.0	0.44	1.5	2.2	1.5	0.14	0.045
32	28	7	30	23	45.5	8	1.0	0.29	2.2	3.3	2.3	0.16	0.045
32	31	7	28	24	45.5	5	1.0	0.51	1.2	1.9	1.3	0.21	0.049
38	26	8	32	28	47.0	5	1.0	0.27	2.4	3.7	2.5	0.14	0.070
38	29	8	32	28	47.0	5	1.0	0.35	1.8	2.8	1.9	0.16	0.075
38	29	8	35	28	55.5	6	1.0	0.28	2.3	3.5	2.4	0.26	0.075
38	35	8	34	30	55.5	5	1.0	0.48	1.3	2.0	1.4	0.34	0.087
45	27	8	38	33	57.0	5	1.0	0.25	2.5	3.9	2.7	0.22	0.100
45	31	8	39	33	57.0	5	1.0	0.30	2.1	3.3	2.2	0.24	0.110
45	31	8	42	33	65.5	6	1.0	0.26	2.4	3.7	2.5	0.38	0.110
45	38	8	40	35	65.5	5	1.0	0.45	1.4	2.2	1.5	0.49	0.130
52	29	9	45	38	65.5	5	1.0	0.22	2.8	4.3	2.9	0.32	0.130
52	35	9	44	39	65.5	5	1.0	0.30	2.1	3.3	2.2	0.40	0.140
52	35	9	49	39	72.0	7	1.5	0.26	2.5	3.8	2.6	0.50	0.140
52	43	9	45	40	72.0	5	1.5	0.47	1.4	2.1	1.4	0.66	0.170
58	31	10	52	43	73.5	6	1.0	0.22	2.9	4.5	3.0	0.41	0.170
58	36	10	50	44	73.5	6	1.0	0.26	2.4	3.8	2.5	0.49	0.190
58	36	10	55	44	82.0	6	1.5	0.25	2.5	3.9	2.6	0.70	0.190
58	46	10	51	45	82.0	6	1.5	0.43	1.5	2.3	1.5	0.90	0.220
65	33	11	57	48	78.5	6	1.0	0.21	3.0	4.7	3.2	0.46	0.230
65	39	11	56	50	78.5	8	1.0	0.26	2.4	3.8	2.5	0.53	0.250
65	39	11	61	50	92.0	6	1.5	0.25	2.5	3.9	2.6	0.94	0.250
65	50	11	57	50	92.0	6	1.5	0.43	1.5	2.3	1.6	1.20	0.280
70	35	12	62	53	83.5	6	1.0	0.20	3.2	4.9	3.3	0.52	0.270
70	42	12	61	55	83.5	10	1.0	0.24	2.6	4.1	2.7	0.58	0.300
70	42	12	68	55	101.0	6	2.0	0.24	2.6	4.0	2.7	1.20	0.300
70	55	12	63	56	101.0	6	2.0	0.43	1.5	2.3	1.5	1.60	0.360
75	37	12	69	60	92.0	7	1.5	0.19	3.3	5.1	3.5	0.69	0.310
75	45	12	68	60	92.0	11	1.5	0.22	2.9	4.5	2.1	0.79	0.390
75	45	12	74	60	111.0	7	2.0	0.24	2.7	4.1	2.8	1.55	0.390
75	59	12	69	61	111.0	7	2.0	0.42	1.5	2.3	1.6	2.05	0.420
80	38	13	75	64	102.0	7	1.5	0.18	3.5	5.4	3.6	0.90	0.350
80	47	13	73	65	102.0	9	1.5	0.23	2.7	4.2	2.8	1.10	0.390
80	47	13	83	65	119.0	7	2.0	0.23	2.8	4.3	2.9	1.95	0.390
80	62	13	74	66	119.0	7	2.0	0.40	1.6	2.4	1.7	2.60	0.490
85	40	14	83	70	112.0	7	1.5	0.18	3.6	5.5	3.7	1.15	0.400
85	50	14	79	70	112.0	9	1.5	0.23	2.8	4.3	2.9	1.45	0.460
85	50	14	89	70	129.0	7	2.0	0.23	2.8	4.3	2.9	2.45	0.460
85	65	14	82	72	129.0	7	2.0	0.39	1.6	2.5	1.7	3.25	0.550
98	43	15	92	80	122.0	7	1.5	0.17	3.6	5.6	3.8	1.35	0.710
98	55	15	90	80	122.0	13	1.5	0.25	2.5	3.9	2.6	1.60	0.830
98	55	15	100	80	149.0	7	2.0	0.22	2.8	4.4	3.0	3.55	0.830
98	73	15	94	82	149.0	7	2.0	0.38	1.6	2.6	1.7	5.15	1.050

Self-Aligning Ball Bearings

Sealed on both sides | Bore 12–65 mm

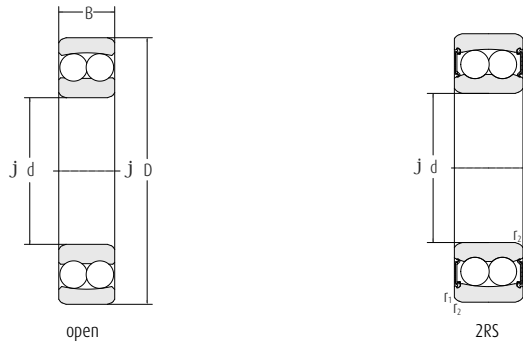

Dimensions				Load ratings		Speed limits Grease	Abbreviation	
d	D	B	r _{1,2} min	dyn. C	stat. C ₀	min ⁻¹	Cylindrical bore	Tapered bore
mm				kN				
12	32	14	0.6	5.60	1.27	16 000	2201-2RSTNG	—
15	35	14	0.6	7.50	1.76	15 000	2202-2RSTNG	—
	42	17	1.0	9.50	2.28	15 000	2302-2RSTN	—
17	40	16	0.6	8.00	2.04	14 000	2203-2RSTNG	—
	47	19	1.0	12.50	3.20	11 000	2303-2RSTN	—
20	47	18	1.0	10.00	2.65	11 000	2204-2RSTNG	2204K2RSTNG
	52	21	1.1	12.50	3.35	10 000	2304-2RSTNG	2304K2RSTNG
25	52	18	1.0	12.20	3.35	9 500	2205-2RSTNG	2205K2RSTNG
	62	24	1.1	18.00	5.00	8 000	2305-2RSTNG	2305K2RSTNG
30	62	20	1.0	15.60	4.65	8 000	2206-2RSTNG	2206K2RSTNG
	72	27	1.1	21.20	6.30	6 700	2306-2RSTNG	2306K2RSTNG
35	72	23	1.1	16.00	5.20	7 000	2207-2RSTNG	2207K2RSTNG
	80	31	1.5	25.00	8.00	6 000	2307-2RSTNG	2307K2RSTNG
40	80	23	1.1	19.30	6.55	6 300	2208-2RSTNG	2208K2RSTNG
	90	33	1.5	29.00	9.65	5 300	2308-2RSTNG	2308K2RSTNG
45	85	23	1.1	22.00	7.35	5 600	2209-2RSTNG	2209K2RSTNG
	100	36	1.5	38.00	12.90	4 800	2309-2RSTNG	2309K2RSTNG
50	90	23	1.1	22.80	8.15	5 300	2210-2RSTNG	2210K2RSTNG
	100	40	2.0	41.50	14.30	4 300	2310-2RSTNG	2310K2RSTNG
55	100	25	1.5	27.00	10.00	4 800	2211-2RSTNG	2211K2RSTNG
	120	43	2.0	51.00	18.00	3 800	2311-2RSTNG	2311K2RSTNG
60	110	28	1.5	30.00	11.60	4 300	2212-2RSTNG	2212K2RSTNG
	120	31	1.5	31.00	12.40	4 000	2213-2RSTNG	2213K2RSTNG

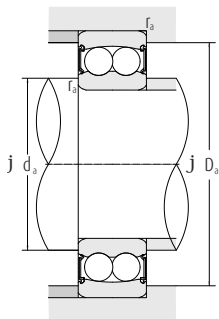

Abutment dimensions (mm)			Factors				Weight
d_a min	D_a max mm	r_a max	e	Y_1 $Fa/fr \leq e$	Y_2 $Fa/fr > e$	Y_0	kg
16.0	28.0	0.6	0.37	1.7	2.6	1.8	0.06
19.0	31.0	0.6	0.34	1.9	2.9	2.0	0.06
20.0	37.0	1.0	0.35	1.8	2.8	1.9	0.13
21.0	36.0	0.6	0.33	1.9	3.0	2.0	0.10
22.0	42.0	1.0	0.32	1.9	3.0	2.0	0.18
25.0	42.0	1.0	0.28	2.2	3.5	2.3	0.16
26.5	45.5	1.0	0.29	2.2	3.3	2.3	0.24
30.0	47.0	1.0	0.27	2.4	3.7	2.5	0.17
31.5	55.5	1.0	0.28	2.3	3.5	2.4	0.38
35.0	57.0	1.0	0.25	2.5	3.9	2.7	0.28
36.5	65.5	1.0	0.26	2.4	3.7	2.5	0.57
41.4	65.5	1.0	0.22	2.8	4.3	2.9	0.45
43.0	72.0	1.5	0.26	2.5	3.8	2.6	0.79
46.5	73.5	1.0	0.22	2.9	4.5	3.0	0.55
48.0	82.0	1.5	0.25	2.5	3.9	2.6	0.05
51.5	78.5	1.0	0.21	3.0	4.7	3.2	0.58
53.0	92.0	1.5	0.25	2.5	3.9	2.6	0.40
56.5	83.5	1.0	0.20	3.2	4.9	3.3	0.63
59.0	101.0	2.0	0.24	2.6	4.0	2.7	1.89
63.0	92.0	1.5	0.19	3.3	5.1	3.5	0.76
66.0	109.0	2.0	0.24	2.7	4.1	2.8	2.37
68.5	101.5	1.5	0.18	3.5	5.4	3.6	1.11
74.0	111.0	1.5	0.18	3.6	5.5	3.7	1.53

Self-Aligning Ball Bearings

With extended inner ring | Bore 20–60 mm

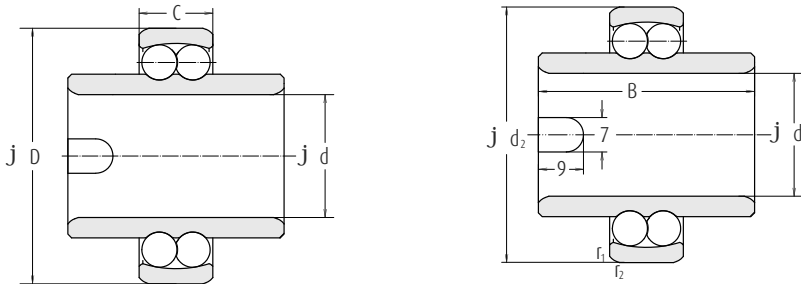

d	Dimensions			Load ratings		Speed limits Grease	Abbreviation
	D	B	$r_{1,2} \text{ min}$	dyn. C	stat. C_0	min^{-1}	
	mm			kN			
20	47	14	1.0	10.0	2.65	9 000	11204TNG
	52	15	1.0	12.5	3.20	8 500	11304TNG
25	52	15	1.0	12.2	3.35	8 000	11205TNG
	62	17	1.0	18.0	5.00	6 700	11305TNG
30	62	16	1.0	15.6	4.65	6 700	11206TNG
	72	19	1.0	21.2	6.30	5 600	11306TNG
35	72	17	1.1	16.0	5.20	5 600	11207TNG
	80	21	1.1	25.0	8.00	5 000	11307TNG
40	80	18	1.1	19.3	6.55	5 000	11208TNG
	90	23	1.1	29.0	9.65	4 500	11308TNG
45	85	19	1.1	22.0	7.35	4 500	11209TNG
	100	25	1.1	38.0	12.90	3 800	11309TNG
50	90	20	1.1	22.8	8.15	4 300	11210TNG
	110	27	1.1	41.5	14.30	3 600	11310TNG
55	100	21	1.5	27.0	10.00	4 000	11211TNG
	60	22	1.5	30.0	11.60	3 600	11212TNG

Note The bore tolerances do not comply with DIN 620. The bore tolerance corresponds to the tolerance zone J7.

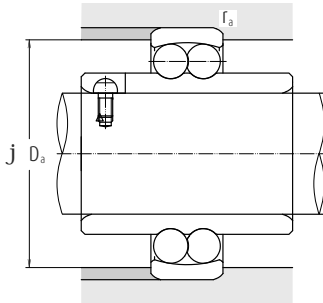

Dimensions		Abutment dimensions		Factors				Weight
d_2	B	D_3 max	r_3 max	e	Y_1 $F_a/F_r \leq e$	Y_2 $F_a/F_r > e$	Y_0	kg
29.2	40	42.0	1.0	0.28	2.2	3.5	2.3	0.18
31.5	44	45.5	1.0	0.29	2.2	3.3	2.3	0.28
33.3	44	47.0	1.0	0.27	2.4	3.7	2.5	0.22
38.0	48	55.5	1.0	0.28	2.3	3.5	2.4	0.43
40.1	48	57.0	1.0	0.25	2.5	3.9	2.7	0.35
45.0	52	65.5	1.0	0.26	2.4	3.7	2.5	0.64
47.7	52	65.5	1.0	0.22	2.8	4.3	2.9	0.54
51.7	56	72.0	1.0	0.26	2.5	3.8	2.6	0.85
54.0	56	73.5	1.0	0.22	2.9	4.5	3.0	0.72
57.7	58	82.0	1.0	0.25	2.5	3.9	2.6	1.12
57.7	58	78.5	1.0	0.21	3.0	4.7	3.2	0.77
63.9	60	92.0	1.0	0.25	2.5	3.9	2.6	1.43
62.7	58	83.5	1.0	0.20	3.2	4.9	3.3	0.85
70.3	62	83.5	1.0	0.24	2.6	4.0	2.7	1.82
70.3	60	92.0	1.5	0.19	3.3	5.1	3.5	1.17
78.0	62	102.0	1.5	0.18	3.5	5.4	3.6	1.50

Self-Aligning Ball Bearings

Sleeve | Shaft 20–50 mm

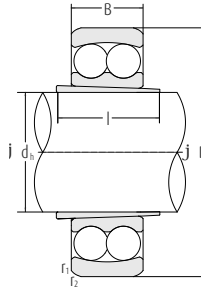

d Shaft	Dimensions					Load ratings		Abbreviation
	d_h	D	B	I	$r_{1,2}$ min	dyn. C	stat. C_0	
	mm					kN		
20	20	47	14	23	1.0	10.0	2.65	11504TNG
25	25	52	15	25	1.0	12.2	3.35	11505TNG
30	30	62	16	25	1.0	15.6	4.65	11506TNG
35	35	72	17	26	1.1	16.0	5.20	11507TNG
40	40	80	18	27	1.1	19.3	6.55	11508TNG
45	45	85	19	28	1.1	22.0	7.35	11509TNG
50	50	90	20	30	1.1	22.8	8.15	11510TNG

Note The bore of the inner ring and its 1:15 taper do not comply with DIN 616.

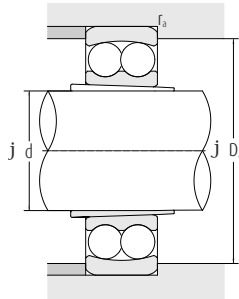

Speed limits		Abutment dimensions		Factors				Weight
Grease min ⁻¹	Oil	D _a max	r _a max mm	e	Y ₁ Fa/Fr ≤ e	Y ₂ Fa/fr > e	Y ₀	kg
15 000	18 000	41.0	1.0	0.28	2.2	3.5	2.3	0.120
13 000	16 000	46.5	1.0	0.27	2.4	3.7	2.5	0.144
11 000	14 000	56.5	1.0	0.25	2.5	3.9	2.7	0.227
9 500	12 000	65.0	1.0	0.22	2.8	4.3	2.9	0.335
8 500	10 000	73.0	1.0	0.22	2.9	4.5	3.0	0.435
7 500	9 000	78.0	1.0	0.21	3.0	4.7	3.2	0.480
7 000	8 500	83.0	1.0	0.20	3.2	4.9	3.3	0.540

Cylindrical Roller Bearings



5. CYLINDRICAL ROLLER BEARINGS

SINGLE-ROW AND DOUBLE-ROW CYLINDRICAL ROLLER BEARINGS

Introduction..... B 142

TECHNICAL DATA

Free Space of Cylindrical Roller Bearings..... B 148

BEARINGS TABLE

SINGLE-ROW CYLINDRICAL ROLLER BEARINGS

Bore Dia.	Page
20 – 500 mm.....	B 150



L-SHAPED THRUST COLLARS FOR CYLINDRICAL ROLLER BEARINGS

Bore Dia.	Page
20 – 320 mm.....	B 174

DOUBLE-ROW CYLINDRICAL ROLLER BEARINGS

Bore Dia.	Page
25 – 360 mm.....	B 176

FULL COMPLEMENT CYLINDRICAL ROLLER BEARINGS SINGLE-ROW(NCF), DOUBLE-ROW(NNCF) AND FOR SHEAVES

Introduction..... B 180

BEARINGS TABLE

SINGLE-ROW(NCF)

Bore Dia.	Page
100 – 800 mm.....	B 184

DOUBLE-ROW(NNCF)

Bore Dia.	Page
100 – 500 mm.....	B 188

FOR SHEAVES OPEN TYPE FIXED-END BEARING RS-48E4, RS-49E4 FREE-END BEARING RSF-48E4, RSF-49E4

Bore Dia.	Page
50 – 560 mm.....	B 192

FOR SHEAVES PRELUBRICATED TYPE RS-50, RS-50NR

Bore Dia.	Page
40 – 400 mm.....	B 196

Cylindrical Roller Bearings

DESIGN, TYPES, AND FEATURES

Depending on the existence of ribs on their rings, Cylindrical Roller Bearings are classified into the following types.

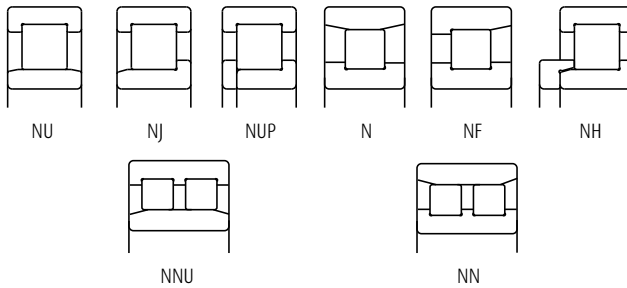

Types NU, N, NNU, and NN are suitable as free-end bearings. Types NJ and NF can sustain limited axial loads in one direction. Types NH and NUP can be used as fixed-end bearings.

NH-type cylindrical roller bearings consist of the NJ-type cylindrical roller bearings and HJ-type L-shaped thrust collars (See Pages B156 to B157).

The inner ring loose rib of a NUP-type cylindrical roller bearing should be mounted so that the marked side is on the outside.

Features of Single-Row Cylindrical Roller Bearings

Cage Specification	Material	Steel	Steel	Polyamide 66 resin	L-PPS resin	Brass	
	Method	pressed		Molded		machined	
	Symbols	W	EW	ET	ET7	M	EM
Features	High Load Capacity	a	F	F	F	b	F
	High-Speed	b	a	a	a	a	F
	High-Temperature	a	a	b	a	a	a
	Vibration	×	×	×	×	b	a

For a given bearing number, if the type of cage is not the standard one, the number of rollers may vary; in such a case, the load rating will differ from the one listed in the bearing tables.

Among the NN Type of double-row bearings, there are many of high precision that have tapered bores, and they are primarily used in the main spindles of machine tools. Their cages are either molded polyphenylenesulfide (PPS) or machined brass.

C Formulation of Bearing Numbers

Single-Row Cylindrical Rollers

Bearing number example:

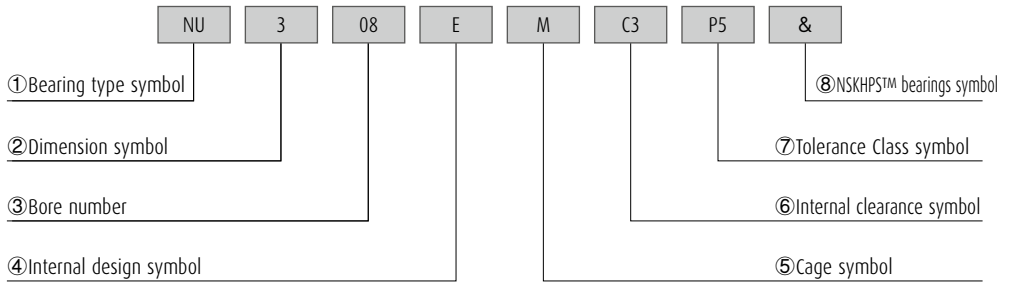

① Bearing type symbol	NU : Single-Row Cylindrical Roller Bearings (Outer ring with both ribs + Inner ring without ribs Please refer to page B124 for detailed information.
② Dimension symbol	10 : 10 Series, 2: 02 Series, 22 : 22 Series, 3 : 03 Series, 23 : 23 Series, 4 : 04 Series,
③ Bore number	Less than 04, Bearing bore 01 : 12mm, 02 : 15mm, 03 : 17mm Over 03, Bearing bore Bore number × 5 (mm)
④ Internal design symbol	E : High Load Capacity
⑤ Cage symbol	W : Pressed Steel Cage, M : Machined Brass Cage, No symbol : Machined Brass Cage (In case of 10 Series) T : Polyamide 66 Resin Cage, T7 : L-PPS Resin Cage
⑥ Radial Internal clearance symbol	For All Radial Brgs. Omitted : CN clearance, C3 : Clearance greater than CN, C4 : Clearance greater than C3, CT : Clearance for Electric Motors (for interchangeable bearings), CG : Special Clearance For Non-Interchangeable Cylindrical Roller Bearings CC : Normal Clearance, CC3 : Clearance greater than CC, CC4 : Clearance greater than CC3, CM : Clearance for Electric Motors (for non-interchangeable bearings), CCG : Special Clearance
⑦ Tolerance Class symbol	Omitted : ISO Normal, P6 : ISO Class 6, P5 : ISO Class 5, P4 : ISO Class 4
⑧ NSKHPS™ symbol	& : NSKHPS™ bearings symbol

PRECAUTIONS FOR USE OF CYLINDRICAL ROLLER BEARINGS

If the load on cylindrical roller bearings becomes too small during operation, slippage between the rollers and raceways occurs, which may result in smearing. Especially with large bearings since the weight of the roller and cage is high.

In case of strong shock loads or vibration, pressed-steel cages are sometimes inadequate.

If very small bearing load or strong shock loads or vibration are expected, please consult with NSK for selection of the bearings.

Bearings with molded polyamide cages (ET type) can be used continuously at temperatures between -40 and 120°C.

If the bearings are used in gear oil, nonflammable hydraulic oil, or ester oil at a high temperature over 100°C, please contact NSK beforehand.

Cylindrical Roller Bearings

TOLERANCES AND RUNNING ACCURACY

	Table	Pages
Cylindrical Roller Bearings	7.2	A128 to A131
Double-Row Cylindrical Roller Bearings	7.2	A128 to A131

Table 2 Tolerances for Roller Inscribed Circle Diameter F_w and Roller Circumscribed Circle Diameter E_w of Cylindrical Roller Bearings Having Interchangeable Rings

Units : μm

Nominal Bore Diameter d (mm)		Tolerances for F_w of types NU, NJ, NUP, NH, and NNU & F_w		Tolerances for E_w of types N, NF, and NN & E_w	
over	incl.	high	low	high	low
—	20	+10	0	0	-10
20	50	+15	0	0	-15
50	120	+20	0	0	-20
120	200	+25	0	0	-25
200	250	+30	0	0	-30
250	315	+35	0	0	-35
315	400	+40	0	0	-40
400	500	+45	0	-	-

RECOMMENDED FITS

	Table	Page
Cylindrical Roller Bearings	8.3	A164
	8.5	A165
Double-Row Cylindrical Roller Bearings	8.3	A164
	8.5	A165

INTERNAL CLEARANCES

	Table	Page
CT and CM clearance fo Electric Motors	8.14.2	A170
Double-Row Cylindrical Roller Bearings	8.15	A171

PERMISSIBLE MISALIGNMENT

The permissible misalignment of cylindrical roller bearings varies depending on the type and internal specifications, but under normal loads, the angles are approximately as follows:

Cylindrical Roller Bearings of width series 0 or 1 0.0012 radian (4')

Cylindrical Roller Bearings of width series 2 0.0006 radian (2')

For double-row cylindrical roller bearings, nearly no misalignment is allowed.



Cylindrical Roller Bearings

LIMITING SPEEDS (Mechanical)

In some single row cylindrical roller bearings, optional cage types are available for special purposes or customer requests. Please consult with NSK about the limiting speeds (mechanical) in the bearing tables are the values for the standard cage type. Refer to point 5.3 on page A099 for detailed information. The limiting speeds (mechanical) in the bearing tab the limiting speeds (mechanical) of optional cage.

LIMITING SPEEDS (Grease/Oil)

The limiting speeds (grease) and limiting speeds (oil) listed in the bearing tables should be adjusted depending on the bearing load condition. Also, higher speeds are attainable by making changes in the lubrication method, cage design, etc. Refer to page A098 for detailed information.



Cylindrical Roller Bearings

TECHNICAL DATA

Free Space of Cylindrical Roller Bearings

Cylindrical roller bearings employ grease lubrication in many cases because it makes maintenance easier and simplifies the peripheral construction of the housing. It is essential to select a grease brand appropriate for the operating conditions while paying due attention to the filling amount and position of the bearing as well as its housing.

The cylindrical roller bearings can be divided into NU, NJ, N, NF, NH, and NUP types of construction according to the collar, collar ring, and position of the inner or outer ring ribs. Even if bearings belong to the same dimension series, they may have different amounts of free space. The free space also differs depending on whether the cage provided is

made from pressed steel or from machined high-tension brass. When determining the grease filling amount, please refer to Tables 1 and 2 which show the free space of NU type bearings. (By the way, the cylindrical roller bearing type is used most frequently).

For types other than the NU type, the free space can be determined from the free space ratio with the NU type. Table 3 shows the approximate free space ratio for each type of cylindrical roller bearing. For example, the free space of NJ310 with a pressed steel cage may be calculated approximately at 47 cm³. This result was calculated by multiplying the free space 52 cm³ of NU310 in Table 1 by the space ratio 0.90 for the NJ type (Table 3).

Table 1 Free Space of Cylindrical Roller Bearing (NU Type) (1) (with Pressed Cage)

Units: cm³

Bearing bore No.	Bearing free space			
	Bearing series			
	NU2	NU3	NU22	NU23
05	6.6	11	7.8	16
06	9.6	17	12	24
07	14	22	14	35
08	18	31	22	44
09	20	42	23	62
10	23	52	26	80
11	30	68	35	102
12	37	85	45	130
13	44	107	57	156
14	51	124	62	179
15	58	155	70	226
16	71	177	85	260
17	85	210	104	300
18	103	244	134	365
19	132	283	164	415
20	151	335	200	540

**Table 2 Free Space of Cylindrical Roller Bearing (NU Type) (2)
(with High-Tension Brass Machined Cage)**

Units: cm³

Bearing bore No.	Bearing free space			
	Bearing series			
	NU2	NU3	NU22	NU23
05	5.0	7.6	5.7	10
06	7.4	12	7.9	16
07	9.6	16	12	27
08	12	21	15	32
09	15	29	16	45
10	18	38	17	58
11	22	52	24	77
12	26	62	31	88
13	31	74	43	104
14	37	92	44	129
15	42	102	50	149
16	51	122	60	181
17	64	164	74	200
18	79	193	96	279
19	94	218	116	280
20	115	221	137	355

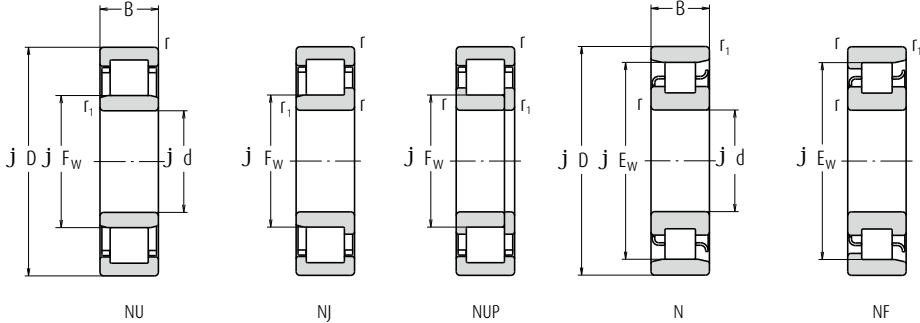

Table 3 Free Space Ratio of Each Type of Cylindrical Roller Bearing

NU Type	NJ Type	N Type	NF Type
1	0.90	1.05	0.95

Single-Row Cylindrical Roller Bearings

Bore Diameter 20 – 30 mm



d	Boundary Dimensions (mm)						Basic Load Ratings (N)		Speeds (min ⁻¹)			
	D	B	r min.	r ₁ min.	F _w	E _w	C _r	C _{0r}	Thermal Reference Speed	Limiting Speeds		
										Mechanical (°)	Grease	
20	47	14	1.0	0.6	—	40	15 400	12 700	15 400	—	12 000	
	47	14	1.0	0.6	26.5	—	25 700	22 600	16 000	—	13 000	
	47	18	1.0	0.6	27.0	—	20 700	18 400	19 000	—	11 000	
	47	18	1.0	0.6	26.5	—	30 500	28 300	19 000	—	11 000	
	52	15	1.1	0.6	—	44.5	21 400	17 300	14 000	—	10 000	
	52	15	1.1	0.6	27.5	—	31 500	26 900	13 000	—	12 000	
	52	21	1.1	0.6	28.5	—	30 500	27 200	14 000	—	11 000	
	52	21	1.1	0.6	27.5	—	42 000	39 000	13 000	—	11 000	
	25	47	12	0.6	0.3	30.5	—	14 300	13 100	15 000	—	15 000
		52	15	1.0	0.6	—	45	17 700	15 700	17 700	—	10 000
52		15	1.0	0.6	31.5	—	33 500	27 700	14 000	17 000	12 000	
52		15	1.0	0.6	31.5	—	29 300	27 700	14 000	17 000	12 000	
52		18	1.0	0.6	31.5	—	40 000	34 500	14 000	20 000	12 000	
52		18	1.0	0.6	31.5	—	35 000	34 500	14 000	20 000	12 000	
62		17	1.1	1.1	—	53	29 300	25 200	12 000	—	8 000	
62		17	1.1	1.1	34.0	—	48 000	37 500	11 000	15 000	10 000	
62		17	1.1	1.1	34.0	—	41 500	37 500	11 000	15 000	10 000	
62		24	1.1	1.1	34.0	—	65 500	56 000	11 000	18 000	9 000	
62		24	1.1	1.1	34.0	—	57 000	56 000	11 000	18 000	9 000	
80		21	1.5	1.5	38.8	62.8	46 500	40 000	9 500	—	7 100	
30	55	13	1.0	0.6	36.5	48.5	19 700	19 600	13 000	—	12 000	
	62	16	1.0	0.6	—	53.5	24 900	23 300	13 000	—	8 500	
	62	16	1.0	0.6	37.5	—	45 000	37 500	12 000	14 000	9 500	
	62	16	1.0	0.6	37.5	—	39 000	37 500	12 000	14 000	9 500	
	62	20	1.0	0.6	37.5	—	56 500	50 000	12 000	17 000	9 500	
	62	20	1.0	0.6	37.5	—	49 000	50 000	12 000	17 000	9 500	
	72	19	1.1	1.1	—	62	38 500	35 000	10 000	—	7 100	
	72	19	1.1	1.1	40.5	—	61 000	50 000	9 500	13 000	8 500	
	72	19	1.1	1.1	40.5	—	53 000	50 000	9 500	13 000	8 500	
	72	27	1.1	1.1	40.5	—	86 000	77 500	9 500	16 000	8 000	
72	27	1.1	1.1	40.5	—	74 500	77 500	9 500	16 000	8 000		
90	23	1.5	1.5	45.0	73	62 500	55 000	8 500	—	6 000		

- Notes**
- (1) (M) in the column of cage symbols are usually omitted from the bearing number.
 - (2) When L-Shaped thrust collars (See section for L-Shaped Thrust Collars starting on page B174) are used, the bearings become the NH type.

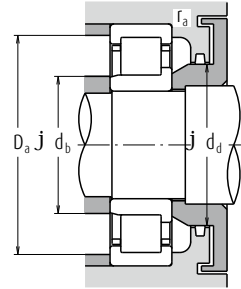
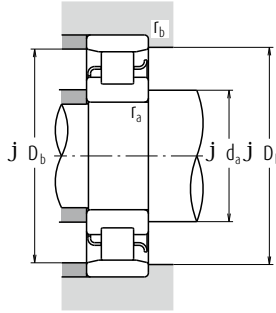
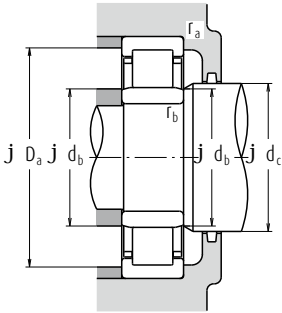

Bearing Numbers		Abutment and Fillet Dimensions (mm)										Mass (kg)						
Cage symbol (1)	Standard option	NU	(2) NJ	NUP	N	NF	d _a (3)	d _b	d _s (4)	d _c	d _d	D _a (3)	D _b	D _b	r _a	r _b	approx.	
							min.	min.	max.	min.	min.	max.	max.	min.	max.	max.		
N 204	W	—	—	—	N	NF	25	—	—	—	—	—	43	42	1	0.6	0.107	
NU 204 E	T T7	NU	NJ	NUP	—	—	25	24	25	29	32	42	—	—	1	0.6	0.107	
NU 2204	W M	NU	NJ	—	—	—	25	24	25	29	32	42	—	—	1	0.6	0.144	
NU 2204 ET	—	NU	NJ	NUP	—	—	25	24	25	29	32	42	—	—	1	0.6	0.138	
N 304	W	—	—	—	N	NF	26.5	—	—	—	—	—	48	46	1	0.6	0.148	
NU 304 E	T T7	NU	NJ	NUP	—	—	26.5	24	26	30	33	45.5	—	—	1	0.6	0.145	
NU 2304	M	—	NU	NJ	NUP	—	26.5	24	27	30	33	45.5	—	—	1	0.6	0.217	
NU 2304 E	T7	—	NU	NJ	NUP	—	26.5	24	26	30	33	45.5	—	—	1	0.6	0.209	
NU 1005	(M)	—	NU	—	—	—	—	27	30	32	—	43	—	—	0.6	0.3	0.094	
N 205	W M	—	—	—	N	NF	30	—	—	—	—	—	48	46	1	0.6	0.135	
NU 205 E*	W M,T,T7	—	—	—	—	—	—	—	—	—	—	—	—	—	—	—	—	
NU 205 E	W M,T,T7	NU	NJ	NUP	—	—	30	29	30	34	37	47	—	—	1	0.6	0.136	
NU 2205 E*	M T,T7	—	—	—	—	—	—	—	—	—	—	—	—	—	—	—	—	
NU 2205 E	M T,T7	NU	NJ	NUP	—	—	30	29	30	34	37	47	—	—	1	0.6	0.16	
N 305	W M	—	—	—	N	NF	31.5	—	—	—	—	—	55.5	50	1	1	0.233	
NU 305 E*	W M,T,T7	—	—	—	—	—	—	—	—	—	—	—	—	—	—	—	—	
NU 305 E	W M,T,T7	NU	NJ	NUP	—	—	31.5	31.5	32	37	40	55.5	—	—	1	1	0.269	
NU 2305 E*	M T, T7	—	—	—	—	—	—	—	—	—	—	—	—	—	—	—	—	
NU 2305 E	M T, T7	NU	NJ	NUP	—	—	31.5	31.5	32	37	40	55.5	—	—	1	1	0.338	
NU 405	W	—	NU	NJ	—	N	NF	33	33	37	41	46	72	72	64	1.5	1.5	0.57
NU 1006	(M)	—	NU	—	—	N	—	35	34	36	38	—	50	51	49	1	0.5	0.136
N 206	W M	—	—	—	N	NF	35	—	—	—	—	—	58	56	1	0.6	0.208	
NU 206 E*	W M,T,T7	—	—	—	—	—	—	—	—	—	—	—	—	—	—	—	—	
NU 206 E	W M,T,T7	NU	NJ	NUP	—	—	35	34	36	40	44	57	—	—	1	0.6	0.205	
NU 2206 E*	M T, T7	—	—	—	—	—	—	—	—	—	—	—	—	—	—	—	—	
NU 2206 E	M T, T7	NU	NJ	NUP	—	—	35	34	36	40	44	57	—	—	1	0.6	0.255	
N 306	W M	—	—	—	N	NF	36.5	—	—	—	—	—	65.5	64	1	1	0.353	
NU 306 E*	W M,T,T7	—	—	—	—	—	—	—	—	—	—	—	—	—	—	—	—	
NU 306 E	W M,T,T7	NU	NJ	NUP	—	—	36.5	36.5	39	44	48	65.5	—	—	1	1	0.409	
NU 2306 E*	M T, T7	—	—	—	—	—	—	—	—	—	—	—	—	—	—	—	—	
NU 2306 E	M T, T7	NU	NJ	NUP	—	—	36.5	36.5	39	44	48	65.5	—	—	1	1	0.518	
NU 406	W M	NU	NJ	—	N	NF	38	38	43	47	52	82	82	75	1.5	1.5	0.758	

Notes (3) If axial loads are applied, increase d_a and reduce D_a from the values listed above.

(4) d_b (max.) are values for adjusting rings for NU, NJ Types.

(5) The limiting speeds (mechanical) in the bearing tables are the value for the standard cage type.

Remark The bearings denoted by an asterisk (*) are NSKHPS Cylindrical roller bearings.

Single-Row Cylindrical Roller Bearings

Bore Diameter 35 – 40 mm

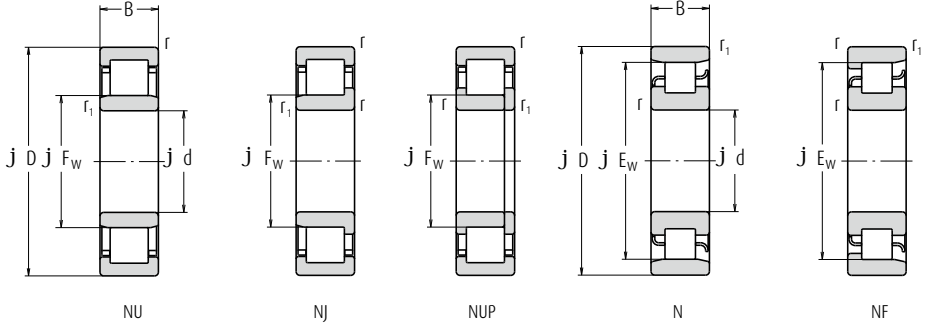

d	Boundary Dimensions (mm)						Basic Load Ratings (N)		Speeds (min ⁻¹)		
	D	B	r min.	r ₁ min.	F _w	E _w	C _r	C _{0r}	Thermal Reference Speed	Limiting Speeds	
										Mechanical (°)	Grease
35	62	14	1.0	0.6	42.0	55	22 600	23 200	11 000	—	11 000
	72	17	1.1	0.6	—	61.8	35 500	34 000	11 000	—	7 500
	72	17	1.1	0.6	44.0	—	58 000	50 000	10 000	12 000	8 500
	72	17	1.1	0.6	44.0	—	50 500	50 000	10 000	12 000	8 500
	72	23	1.1	0.6	44.0	—	71 000	65 500	11 000	15 000	8 500
	72	23	1.1	0.6	44.0	—	61 500	65 500	11 000	15 000	8 500
	80	21	1.5	1.1	—	68.2	49 500	47 000	9 500	—	6 300
	80	21	1.5	1.1	46.2	—	76 500	65 500	8 500	11 000	7 500
	80	21	1.5	1.1	46.2	—	66 500	65 500	8 500	11 000	7 500
	80	31	1.5	1.1	46.2	—	107 000	101 000	9 000	14 000	6 700
40	80	31	1.5	1.1	46.2	—	93 000	101 000	9 000	14 000	6 700
	100	25	1.5	1.5	53.0	83	75 500	69 000	7 500	—	5 300
	68	15	1.0	0.6	47.0	61	27 300	29 000	10 000	—	10 000
	80	18	1.1	1.1	—	70	43 500	43 000	9 500	—	6 700
	80	18	1.1	1.1	49.5	—	64 000	55 500	9 000	11 000	7 500
	80	18	1.1	1.1	49.5	—	55 500	55 500	9 000	11 000	7 500
	80	23	1.1	1.1	49.5	—	83 000	77 500	9 000	13 000	7 500
	80	23	1.1	1.1	49.5	—	72 500	77 500	9 000	13 000	7 500
	90	23	1.5	1.5	—	77.5	58 500	57 000	8 500	—	5 600
	90	23	1.5	1.5	52.0	—	95 500	81 500	7 500	10 000	6 700
40	90	23	1.5	1.5	52.0	—	83 000	81 500	7 500	10 000	6 700
	90	33	1.5	1.5	52.0	—	131 000	122 000	8 000	12 000	6 000
	90	33	1.5	1.5	52.0	—	114 000	122 000	8 000	12 000	6 000
	110	27	2.0	2.0	58.0	92	95 500	89 000	6 700	—	4 800

- Notes**
- (1) (M) in the column of cage symbols are usually omitted from the bearing number.
 - (2) When L-Shaped thrust collars (See section for L-Shaped Thrust Collars starting on page B174) are used, the bearings become the NH type.

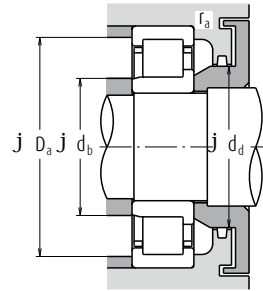
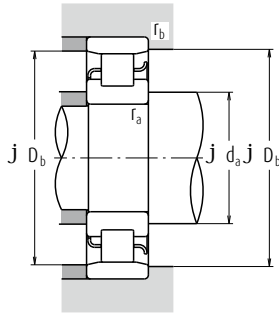
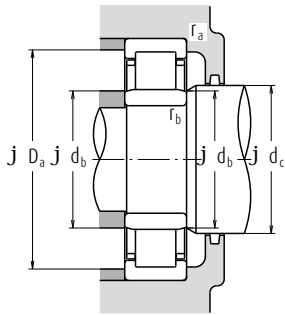

Bearing Numbers							Abutment and Fillet Dimensions (mm)										Mass (kg)	
Cage symbol (1) Standard option	NU	NJ	NUP	N	NF	d _c (2) min.	d _b min.	d _s (4) max.	d _c min.	d _d min.	D _a (3) max.	D _b max.	D _b min.	r _a max.	r _b max.	approx.		
																	(2) NJ	NUP
NU 1007	(M)	—	NU	NJ	—	N	—	40	39	41	44	—	57	58	56	1	0.5	0.18
N 207	W	M	—	—	—	N	NF	41.5	—	—	—	—	—	68	64	1	0.6	0.301
NU 207 E*	W	M, T, T7	—	—	—	—	—	—	—	—	—	—	—	—	—	—	—	—
NU 207 E	W	M, T, T7	NU	NJ	NUP	—	—	41.5	39	42	46	50	65.5	—	—	1	0.6	0.304
NU 2207 E*	M	T, T7	—	—	—	—	—	—	—	—	—	—	—	—	—	—	—	—
NU 2207 E	M	T, T7	NU	NJ	NUP	—	—	41.5	39	42	46	50	65.5	—	—	1	0.6	0.40
N 307	W	M	—	—	—	N	NF	43	—	—	—	—	—	73.5	70	1.5	1	0.476
NU 307 E*	W	M, T, T7	—	—	—	—	—	—	—	—	—	—	—	—	—	—	—	—
NU 307 E	W	M, T, T7	NU	NJ	NUP	—	—	41.5	41.5	44	48	53	72	—	—	1.5	1	0.545
NU 2307 E*	M	T, T7	—	—	—	—	—	—	—	—	—	—	—	—	—	—	—	—
NU 2307 E	M	T, T7	NU	NJ	NUP	—	—	43	41.5	44	48	53	72	—	—	1.5	1	0.711
NU 407	W	—	NU	NJ	—	N	NF	43	43	51	55	61	92	92	85	1.5	1.5	1.01
NU 1008	(M)	—	NU	NJ	NUP	N	—	45	44	46	49	—	63	64	62	1	0.6	0.223
N 208	W	M	—	—	—	N	NF	46.5	—	—	—	—	—	73.5	72	1	1	0.375
NU 208 E*	W	M, T, T7	—	—	—	—	—	—	—	—	—	—	—	—	—	—	—	—
NU 208 E	W	M, T, T7	NU	NJ	NUP	—	—	46.5	46.5	48	52	56	73.5	—	—	1	1	0.379
NU 2208 E*	M	T, T7	—	—	—	—	—	—	—	—	—	—	—	—	—	—	—	—
NU 2208 E	M	T, T7	NU	NJ	NUP	—	—	46.5	46.5	48	52	56	73.5	—	—	1	1	0.480
N 308	W	M	—	—	—	N	NF	48	—	—	—	—	—	82	79	1.5	1.5	0.649
NU 308 E*	W	M, T, T7	—	—	—	—	—	—	—	—	—	—	—	—	—	—	—	—
NU 308 E	W	M, T, T7	NU	NJ	NUP	—	—	48	48	50	55	60	82	—	—	1.5	1.5	0.747
NU 2308 E*	M	T, T7	—	—	—	—	—	—	—	—	—	—	—	—	—	—	—	—
NU 2308 ET	M	T, T7	NU	NJ	NUP	—	—	48	48	50	55	60	82	—	—	1.5	1.5	0.933
NU 408	W	—	NU	NJ	NUP	N	NF	49	49	56	60	67	101	101	94	2	2	1.28

- Notes**
- (3) If axial loads are applied, increase d_s and reduce D_a from the values listed above.
 - (4) d_b (max.) are values for adjusting rings for NU, NJ Types.
 - (5) The limiting speeds (mechanical) in the bearing tables are the value for the standard cage type.

Remark The bearings denoted by an asterisk (*) are NSKHS Cylindrical roller bearings.

Single-Row Cylindrical Roller Bearings

Bore Diameter 45 – 50 mm

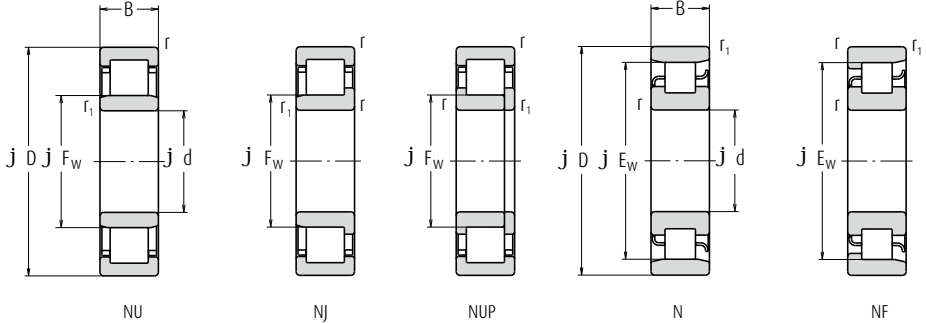

d	Boundary Dimensions (mm)						Basic Load Ratings (N)		Speeds (min ⁻¹)			
	D	B	r min.	r ₁ min.	F _w	E _w	C _r	C _{0r}	Thermal Reference Speed	Limiting Speeds		
										Mechanical (°)	Grease	
45	75	16	1.0	0.6	52.5	67.5	32 500	35 500	9 500	—	9 300	
	85	19	1.1	1.1	—	75	46 000	47 000	9 500	—	6 300	
	85	19	1.1	1.1	54.5	—	72 500	66 500	8 500	10 000	6 700	
	85	19	1.1	1.1	54.5	—	63 000	66 500	8 500	10 000	6 700	
	85	23	1.1	1.1	54.5	—	87 500	84 500	8 500	12 000	6 700	
	85	23	1.1	1.1	54.5	—	76 000	84 500	8 500	12 000	6 700	
	100	25	1.5	1.5	—	86.5	79 000	77 500	7 500	—	5 000	
	100	25	1.5	1.5	58.5	—	112 000	98 500	7 100	9 000	6 000	
	100	25	1.5	1.5	58.5	—	97 500	98 500	7 100	9 000	6 000	
	100	36	1.5	1.5	58.5	—	158 000	153 000	7 100	11 000	5 300	
	100	36	1.5	1.5	58.5	—	137 000	153 000	7 100	11 000	5 300	
	120	29	2.0	2.0	64.5	100.5	107 000	102 000	6 300	—	4 300	
	50	80	16	1.0	0.6	57.5	72.5	32 000	36 000	8 500	—	8 000
		90	20	1.1	1.1	—	80.4	48 000	51 000	8 500	—	5 600
90		20	1.1	1.1	59.5	—	79 500	76 500	8 000	9 000	6 300	
90		20	1.1	1.1	59.5	—	69 000	76 500	8 000	9 000	6 300	
90		23	1.1	1.1	59.5	—	96 000	97 000	7 500	11 000	6 300	
90		23	1.1	1.1	59.5	—	83 500	97 000	7 500	11 000	6 300	
110		27	2.0	2.0	—	95	87 000	86 000	7 100	—	4 500	
110		27	2.0	2.0	65.0	—	127 000	113 000	6 700	8 000	5 000	
110		27	2.0	2.0	65.0	—	110 000	113 000	6 700	8 000	5 000	
110		40	2.0	2.0	65.0	—	187 000	187 000	6 700	10 000	5 000	
110		40	2.0	2.0	65.0	—	163 000	187 000	6 700	10 000	5 000	
130		31	2.1	2.1	—	110.8	139 000	136 000	5 600	—	4 000	
130		31	2.1	2.1	70.8	110.8	129 000	124 000	5 600	—	4 000	

- Notes**
- (1) (M) in the column of cage symbols are usually omitted from the bearing number.
 - (2) When L-Shaped thrust collars (See section for L-Shaped Thrust Collars starting on page B174) are used, the bearings become the NH type.

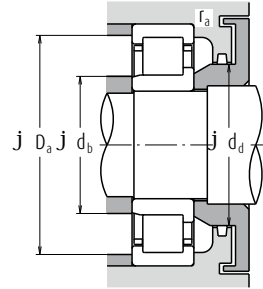
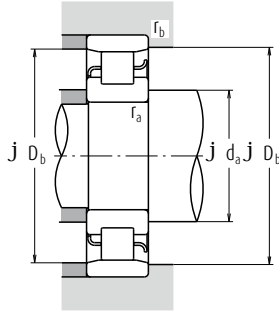
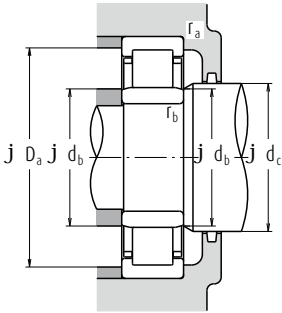

Bearing Numbers								Abutment and Fillet Dimensions (mm)								Mass (kg)		
Cage symbol (1)	NU	(2) NJ	NUP	N	NF	d _a (3) min.	d _b min.	d _b (4) max.	d _c min.	d _d min.	D _a (3) max.	D _b min.	D _b max.	r _a max.	r _b max.	approx.		
																	(M)	W
NU 1009	(M)	—	NU	—	—	N	NF	50	49	51	54	—	70	71	68	1	0.6	0.279
N 209	W	M	—	—	—	N	NF	51.5	—	—	—	—	—	78.5	77	1	1	0.429
NU 209 E*	W	M, T, T7	—	—	—	—	—	—	—	—	—	—	—	—	—	—	—	—
NU 209 E	W	M, T, T7	NU	NJ	NUP	—	—	—	—	—	—	—	—	—	—	—	—	—
NU 2209 E*	M	T, T7	—	—	—	—	—	—	—	—	—	—	—	—	—	—	—	—
NU 2209 E	M	T, T7	NU	NJ	NUP	—	—	—	—	—	—	—	—	—	—	—	—	—
N 309	W	M	—	—	—	N	NF	53	—	—	—	—	—	92	77	1.5	1.5	0.869
NU 309 E*	W	M, T, T7	—	—	—	—	—	—	—	—	—	—	—	—	—	—	—	—
NU 309 E	W	M, T, T7	NU	NJ	NUP	—	—	—	—	—	—	—	—	—	—	—	—	—
NU 2309 E*	M	T, T7	—	—	—	—	—	—	—	—	—	—	—	—	—	—	—	—
NU 2309 E	M	T, T7	NU	NJ	NUP	—	—	—	—	—	—	—	—	—	—	—	—	—
NU 409	W	—	NU	NJ	NUP	N	NF	54	54	62	66	74	111	111	103	2	2	1.62
NU 1010	(M)	—	NU	NJ	NUP	N	—	55	54	56	59	—	75	76	73	1	0.6	0.301
N 210	W	M	—	—	—	N	NF	56.5	—	—	—	—	—	83.5	82	1	1	0.483
NU 210 E*	W	M, T, T7	—	—	—	—	—	—	—	—	—	—	—	—	—	—	—	—
NU 210 E	W	M, T, T7	NU	NJ	NUP	—	—	56.5	56.5	57	62	67	83.5	—	—	1	1	0.50
NU 2210 E*	M	T, T7	—	—	—	—	—	—	—	—	—	—	—	—	—	—	—	—
NU 2210 E	M	T, T7	NU	NJ	NUP	—	—	56.5	56.5	57	62	67	83.5	—	—	1	1	0.562
N 310	W	M	—	—	—	N	NF	59	—	—	—	—	—	101	97	2	2	1.11
NU 310 E*	W	M, T, T7	—	—	—	—	—	—	—	—	—	—	—	—	—	—	—	—
NU 310 E	W	M, T, T7	NU	NJ	NUP	—	—	59	59	63	67	73	101	—	—	2	2	1.3
NU 2310 E*	M	T, T7	—	—	—	—	—	—	—	—	—	—	—	—	—	—	—	—
NU 2310 E	M	T, T7	NU	NJ	NUP	—	—	59	59	63	67	73	101	—	—	2	2	1.7
N 410	W	M	—	—	—	N	NF	65	—	—	—	—	—	117	113	2	2	2.0
NU 410	W	M	NU	NJ	NUP	—	—	61	61	68	73	81	119	119	113.3	2	2	1.99

- Notes**
- (3) If axial loads are applied, increase d_a and reduce D_a from the values listed above.
 - (4) d_b (max.) are values for adjusting rings for NU, NJ Types.
 - (5) The limiting speeds (mechanical) in the bearing tables are the value for the standard cage type.

Remark The bearings denoted by an asterisk (*) are NSKHPS Cylindrical roller bearings.

Single-Row Cylindrical Roller Bearings

Bore Diameter 55 – 60 mm

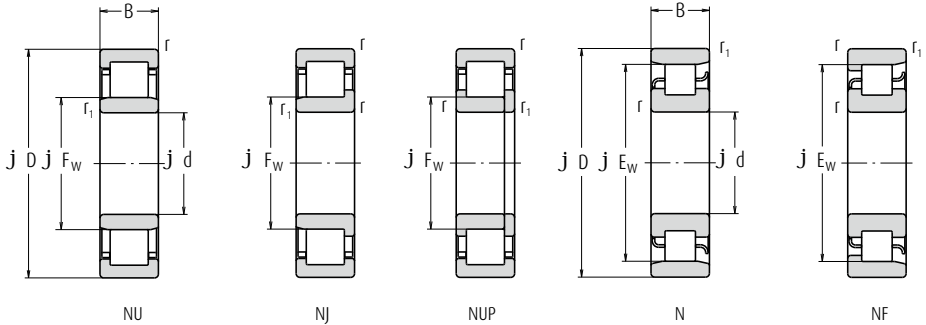

d	Boundary Dimensions (mm)						Basic Load Ratings (N)		Speeds (min ⁻¹)			
	D	B	r min.	r ₁ min.	F _w	E _w	C _r	C _{0r}	Thermal Reference Speed	Limiting Speeds		
										Mechanical (°)	Grease	
55	90	18	1.1	1.0	64.5	80.5	37 500	44 000	8 000	—	7 500	
	100	21	1.5	1.1	—	88.5	58 000	62 500	7 500	—	5 300	
	100	21	1.5	1.1	66.0	—	99 000	98 500	6 700	8 500	5 600	
	100	21	1.5	1.1	66.0	—	86 500	98 500	6 700	8 500	5 600	
	100	25	1.5	1.1	66.0	—	117 000	122 000	6 700	10 000	5 600	
	100	25	1.5	1.1	66.0	—	101 000	122 000	6 700	10 000	5 600	
	120	29	2.0	2.0	—	104.5	111 000	111 000	6 300	—	4 000	
	120	29	2.0	2.0	70.5	—	158 000	143 000	6 000	7 500	4 500	
	120	29	2.0	2.0	70.5	—	137 000	143 000	6 000	7 500	4 500	
	120	43	2.0	2.0	70.5	—	231 000	233 000	6 000	9 000	4 500	
	120	43	2.0	2.0	70.5	—	201 000	233 000	6 000	9 000	4 500	
	140	33	2.1	2.1	77.2	117.2	139 000	138 000	5 300	—	3 800	
	60	95	18	1.1	1.0	69.5	85.5	40 000	48 500	7 500	—	6 700
		110	22	1.5	1.5	—	97.5	68 500	75 000	7 100	—	4 800
110		22	1.5	1.5	72.0	—	112 000	107 000	6 300	7 500	5 300	
110		22	1.5	1.5	72.0	—	97 500	107 000	6 300	7 500	5 300	
110		28	1.5	1.5	72.0	—	151 000	157 000	6 300	9 500	5 300	
110		28	1.5	1.5	72.0	—	131 000	157 000	6 300	9 500	5 300	
130		31	2.1	2.1	—	113	124 000	126 000	6 000	—	3 800	
130		31	2.1	2.1	77.0	—	124 000	126 000	6 000	—	3 800	
130		31	2.1	2.1	77.0	—	169 000	157 000	5 600	9 500	4 800	
130		31	2.1	2.1	77.0	—	150 000	157 000	5 600	9 500	4 800	
130		46	2.1	2.1	77.0	—	251 000	262 000	5 600	8 500	4 300	
130		46	2.1	2.1	77.0	—	222 000	262 000	5 600	8 500	4 300	
150		35	2.1	2.1	83.0	127	167 000	168 000	5 000	—	3 400	

- Notes**
- (1) (M) in the column of cage symbols are usually omitted from the bearing number.
 - (2) When L-Shaped thrust collars (See section for L-Shaped Thrust Collars starting on page B174) are used, the bearings become the NH type.

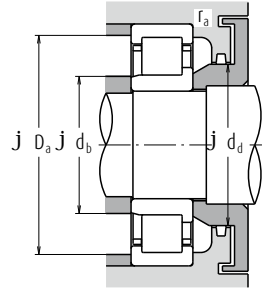
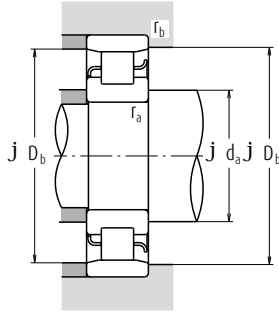
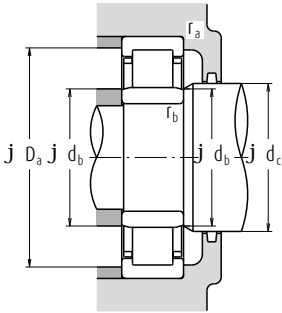

Bearing Numbers							Abutment and Fillet Dimensions (mm)										Mass (kg)	
	Cage symbol (1)	Standard option	NU	(2) NJ	NUP	N	NF	d _c (3)	d _b	d _s (4)	d _c	d _d	D _a (3)	D _b	D _b	r _a	r _b	approx.
								min.	min.	max.	min.	min.	max.	max.	min.	max.	max.	
NU 1011	(M)	—	NU	NJ	—	N	—	61.5	60	63	66	—	83.5	85	82	1	1	0.445
N 211	W	M	—	—	—	N	NF	63	—	—	—	—	—	93.5	91	1.5	1	0.634
NU 211 E*	W	M, T, T7	—	—	—	—	—	—	—	—	—	—	—	—	—	—	—	—
NU 211 E	W	M, T, T7	NU	NJ	NUP	—	—	63	61.5	64	68	73	92	—	—	1.5	1	0.669
NU 2211 E*	M	T, T7	—	—	—	—	—	—	—	—	—	—	—	—	—	—	—	—
NU 2211 ET	M	T, T7	NU	NJ	NUP	—	—	63	61.5	64	68	73	92	—	—	1.5	1	0.783
N 311	W	M	—	—	—	N	NF	64	—	—	—	—	—	111	107	2	2	1.42
NU 311 E*	W	M, T, T7	—	—	—	—	—	—	—	—	—	—	—	—	—	—	—	—
NU 311 E	W	M, T, T7	NU	NJ	NUP	—	—	64	64	68	72	80	111	—	—	2	2	1.64
NU 2311 E*	M	T, T7	—	—	—	—	—	—	—	—	—	—	—	—	—	—	—	—
NU 2311 E	M	T, T7	NU	NJ	NUP	—	—	64	64	68	72	80	111	—	—	2	2	2.18
NU 411	W	—	NU	NJ	NUP	N	NF	66	66	75	79	87	129	129	119	2	2	2.5
NU 1012	(M)	—	NU	NJ	—	N	NF	66.5	65	68	71	—	88.5	90	87	1	1	0.474
N 212	W	M	—	—	—	N	NF	68	—	—	—	—	—	102	100	1.5	1.5	0.823
NU 212 E*	W	M, T, T7	—	—	—	—	—	—	—	—	—	—	—	—	—	—	—	—
NU 212 E	W	M, T, T7	NU	NJ	NUP	—	—	68	68	70	75	80	102	—	—	1.5	1.5	0.824
NU 2212 E*	M	T, T7	—	—	—	—	—	—	—	—	—	—	—	—	—	—	—	—
NU 2212 E	M	T, T7	NU	NJ	NUP	—	—	68	68	70	75	80	102	—	—	1.5	1.5	1.06
N 312	W	M	—	—	—	N	NF	71	—	—	—	—	—	119	115	2	2	1.78
NU 312	W	M	NU	NJ	NUP	—	—	71	71	75	79	86	119	—	—	2	2	1.82
NU 312 E*	M	T, T7	—	—	—	—	—	—	—	—	—	—	—	—	—	—	—	—
NU 312 E	M	T, T7	NU	NJ	NUP	—	—	71	71	75	79	86	119	—	—	2	2	2.06
NU 2312 E*	M	T, T7	—	—	—	—	—	—	—	—	—	—	—	—	—	—	—	—
NU 2312 ET	M	T, T7	NU	NJ	NUP	—	—	71	71	75	79	86	119	—	—	2	2	2.7
NU 412	W	M	NU	NJ	NUP	N	NF	71	71	80	85	94	139	139	130	2	2	3.04

Notes (3) If axial loads are applied, increase d_a and reduce D_a from the values listed above.

(4) d_b (max.) are values for adjusting rings for NU, NJ Types.

(5) The limiting speeds (mechanical) in the bearing tables are the value for the standard cage type.

Remark The bearings denoted by an asterisk (*) are NSKHPS Cylindrical roller bearings.

Single-Row Cylindrical Roller Bearings

Bore Diameter 65 – 70 mm

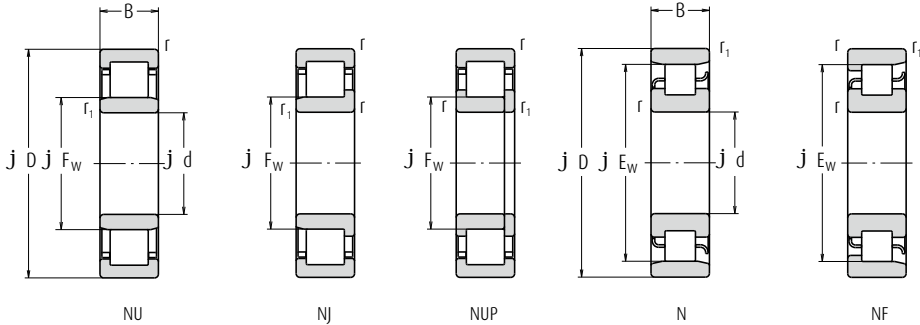

d	Boundary Dimensions (mm)						Basic Load Ratings (N)		Speeds (min ⁻¹)			
	D	B	r min.	r ₁ min.	F _w	E _w	C _r	C _{0r}	Thermal Reference Speed	Limiting Speeds		
										Mechanical (°)	Grease	
65	100	18	1.1	1.0	74.5	90.5	41 000	51 000	6 700	—	6 300	
	120	23	1.5	1.5	—	105.6	84 000	94 500	6 300	—	4 300	
	120	23	1.5	1.5	78.5	—	124 000	119 000	6 000	7 100	4 800	
	120	23	1.5	1.5	78.5	—	108 000	119 000	6 000	7 100	4 800	
	120	31	1.5	1.5	78.5	—	171 000	181 000	6 000	8 500	4 800	
	120	31	1.5	1.5	78.5	—	149 000	181 000	6 000	8 500	4 800	
	140	33	2.1	2.1	—	121.5	135 000	139 000	5 600	—	3 600	
	140	33	2.1	2.1	83.5	—	135 000	139 000	5 600	—	3 600	
	140	33	2.1	2.1	82.5	—	204 000	191 000	5 300	8 500	4 300	
	140	33	2.1	2.1	82.5	—	181 000	191 000	5 300	8 500	4 300	
	140	48	2.1	2.1	82.5	—	263 000	265 000	5 600	7 500	3 800	
	140	48	2.1	2.1	82.5	—	233 000	265 000	5 600	7 500	3 800	
	160	37	2.1	2.1	—	135.3	195 000	203 000	4 500	—	4 000	
	160	37	2.1	2.1	89.3	—	182 000	186 000	4 800	—	3 200	
	70	110	20	1.1	1.0	80.0	100	58 500	70 500	6 300	—	6 000
		125	24	1.5	1.5	—	110.5	83 500	95 000	6 300	—	4 000
125		24	1.5	1.5	83.5	—	136 000	137 000	5 600	9 000	5 000	
125		24	1.5	1.5	83.5	—	119 000	137 000	5 600	9 000	5 000	
125		31	1.5	1.5	83.5	—	179 000	194 000	5 600	8 000	4 500	
125		31	1.5	1.5	83.5	—	156 000	194 000	5 600	8 000	4 500	
150		35	2.1	2.1	—	130	149 000	156 000	5 600	—	3 200	
150		35	2.1	2.1	89.0	—	231 000	222 000	4 800	8 000	3 200	
150		35	2.1	2.1	90.0	—	231 000	222 000	4 800	8 000	4 000	
150		35	2.1	2.1	89.0	—	205 000	222 000	4 800	8 000	4 000	
150		51	2.1	2.1	89.0	—	310 000	325 000	5 000	7 100	3 600	
150		51	2.1	2.1	89.0	—	274 000	325 000	5 000	7 100	3 600	
180		42	3.0	3.0	100.0	152	228 000	236 000	4 500	—	2 800	

- Notes** (1) (M) in the column of cage symbols are usually omitted from the bearing number.
 (2) When L-Shaped thrust collars (See section for L-Shaped Thrust Collars starting on page B174) are used, the bearings become the NH type.

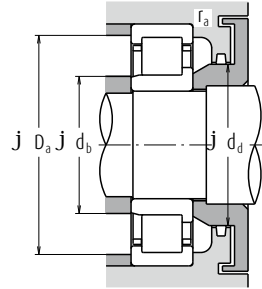
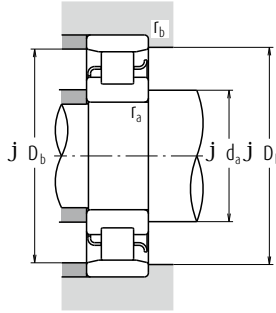
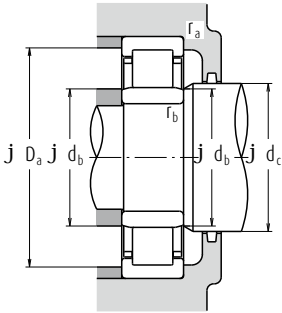

Bearing Numbers								Abutment and Fillet Dimensions (mm)										Mass (kg)
Cage symbol (1) Standard option	NU	NJ	NUP	N	NF	d _a (2) min.	d _b min.	d _b (4) max.	d _c min.	d _d min.	D _a (2)	D _b	D _b	r _a	r _b	approx.		
											max.	max.	min.	max.	max.			
NU 1013	(M)	—	NU	NJ	—	N	NF	71.5	70	73	76	—	93.5	95	92	1	1	0.504
N 213	W	M	—	—	—	N	NF	73	—	—	—	—	112	108	1.5	1.5	1.05	
NU 213 E*	W	M, T, T7	NU	NJ	NUP	—	—	73	73	76	81	87	112	—	—	1.5	1.5	1.05
NU 213 E	W	M, T, T7	NU	NJ	NUP	—	—	73	73	76	81	87	112	—	—	1.5	1.5	1.05
NU 2213 E*	M	T, T7	NU	NJ	NUP	—	—	73	73	76	81	87	112	—	—	1.5	1.5	1.41
NU 2213 E	M	T, T7	NU	NJ	NUP	—	—	73	73	76	81	87	112	—	—	1.5	1.5	1.41
N 313	W	M	—	—	—	N	NF	76	—	—	—	—	129	125	2	2	2.17	
NU 313	W	M	NU	NJ	NUP	—	—	76	76	81	85	93	129	—	—	2	2	2.23
NU 313 E*	M	T, T7	NU	NJ	NUP	—	—	76	76	80	85	93	129	—	—	2	2	2.56
NU 313 E	M	T, T7	NU	NJ	NUP	—	—	76	76	80	85	93	129	—	—	2	2	2.56
NU 2313 E*	M	T, T7	NU	NJ	NUP	—	—	76	76	80	85	93	129	—	—	2	2	3.16
NU 2313 E	M	T, T7	NU	NJ	NUP	—	—	76	76	80	85	93	129	—	—	2	2	3.16
N 413	M	—	—	—	—	N	NF	76	—	—	—	—	149	138.8	2	2	3.63	
NU 413	W	M	NU	NJ	—	—	—	76	76	86	91	100	149	—	—	2	2	3.63
NU 1014	(M)	—	NU	NJ	NUP	N	NF	76.5	75	79	82	—	103.5	105	101	1	1	0.693
N 214	W	M	—	—	—	N	NF	78	—	—	—	—	117	113	1.5	1.5	1.14	
NU 214 E*	M	T, T7	NU	NJ	NUP	—	—	78	78	81	86	92	117	—	—	1.5	1.5	1.29
NU 214 E	M	T, T7	NU	NJ	NUP	—	—	78	78	81	86	92	117	—	—	1.5	1.5	1.29
NU 2214 E*	M	T, T7	NU	NJ	NUP	—	—	78	78	81	86	92	117	—	—	1.5	1.5	1.14
NU 2214 E	M	T, T7	NU	NJ	NUP	—	—	78	78	81	86	92	117	—	—	1.5	1.5	1.49
N 314	W	M	—	—	—	N	NF	81	—	—	—	—	139	133.5	2	2	2.67	
NU 314	W	M	NU	NJ	NUP	—	—	81	81	87	92	100	139	—	—	2	2	2.75
NU 314 E*	M	T, T7	NU	NJ	NUP	—	—	81	81	87	92	100	139	—	—	2	2	3.09
NU 314 E	M	T, T7	NU	NJ	NUP	—	—	81	81	86	92	100	139	—	—	2	2	3.09
NU 2314 E*	M	T, T7	NU	NJ	NUP	—	—	81	81	86	92	100	139	—	—	2	2	3.92
NU 2314 E	M	T, T7	NU	NJ	NUP	—	—	81	81	86	92	100	139	—	—	2	2	3.92
NU 414	W	M	NU	NJ	NUP	N	NF	83	83	97	102	112	167	167	155	2.5	2.5	5.28

Notes (3) If axial loads are applied, increase d_a and reduce D_a from the values listed above.

(4) d_b (max.) are values for adjusting rings for NU, NJ Types.

(5) The limiting speeds (mechanical) in the bearing tables are the value for the standard cage type.

Remark The bearings denoted by an asterisk (*) are NSK HPS Cylindrical roller bearings.

Single-Row Cylindrical Roller Bearings

Bore Diameter 75 mm

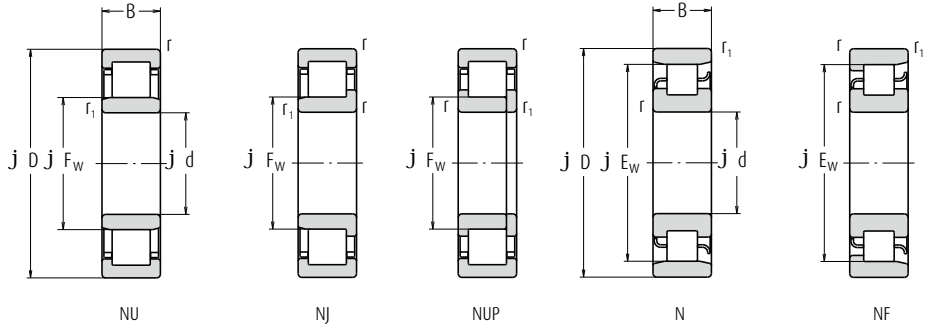

Boundary Dimensions (mm)							Basic Load Ratings (N)		Speeds (min ⁻¹)		
d	D	B	r min.	r ₁ min.	F _W	E _W	C _r	C _{0r}	Thermal Reference Speed	Limiting Speeds	
										Mechanical (°)	Grease
75	115	20	1.1	1.0	85.0	105	60 000	74 500	6 000	—	5 600
	130	25	1.5	1.5	—	116.5	96 500	111 000	6 000	—	3 800
	130	25	1.5	1.5	88.5	—	150 000	156 000	5 300	8 500	4 800
	130	25	1.5	1.5	88.5	—	130 000	156 000	5 300	8 500	4 800
	130	31	1.5	1.5	88.5	—	186 000	207 000	5 300	7 500	4 300
	130	31	1.5	1.5	88.5	—	162 000	207 000	5 300	7 500	4 300
	160	37	2.1	2.1	—	139.5	179 000	189 000	5 000	—	3 000
	160	37	2.1	2.1	95.5	—	179 000	189 000	5 000	—	3 000
	160	37	2.1	2.1	95.0	—	271 000	263 000	4 500	7 500	3 800
	160	37	2.1	2.1	95.0	—	240 000	263 000	4 500	7 500	3 800
	160	55	2.1	2.1	95.0	—	370 000	395 000	4 800	6 700	3 400
	160	55	2.1	2.1	95.0	—	330 000	395 000	4 800	6 700	3 400
	190	45	3.0	3.0	104.5	160.5	262 000	274 000	4 300	—	2 600

- Notes**
- (1) (M) in the column of cage symbols are usually omitted from the bearing number.
 - (2) When L-Shaped thrust collars (See section for L-Shaped Thrust Collars starting on page B174) are used, the bearings become the NH type.

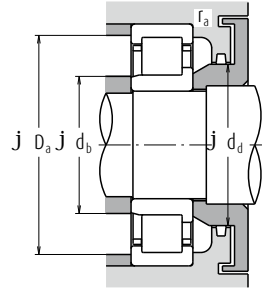
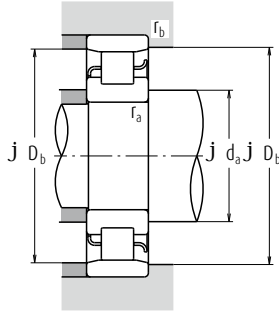
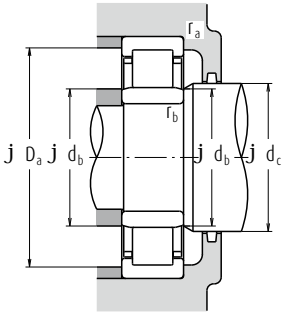

Bearing Numbers								Abutment and Fillet Dimensions (mm)								Mass (kg)		
Cage symbol (1) Standard option	NU	(2)		NUP	N	NF	d _a (3) min.	d _b min.	d _b (4) max.	d _c min.	d _d min.	D _b (3)		r _a max.	r _b max.	approx.		
		NJ	NUP									max.	max.					
NU 1015	(M)	—	—	—	N	NF	81.5	80	83	87	—	108.5	110	106	1	1	0.731	
N 215	W	M	—	—	N	NF	83	—	—	—	—	—	122	119	1.5	1.5	1.23	
NU 215 E*	M	T, T7	—	—	—	—	—	—	—	—	—	—	—	—	—	—	—	
NU 215 E	M	T, T7	NU	NJ	NUP	—	83	83	86	90	96	122	—	—	1.5	1.5	1.44	
NU 2215 E*	M	T, T7	—	—	—	—	—	—	—	—	—	—	—	—	—	—	—	
NU 2215 E	M	T, T7	NU	NJ	NUP	—	83	83	86	90	96	122	—	—	1.5	1.5	1.57	
N 315	W	M	—	—	N	NF	86	—	—	—	—	—	149	143	2	2	3.2	
NU 315	W	T, T7	NU	NJ	NUP	—	86	86	93	97	106	149	—	—	2	2	3.26	
NU 315 E*	M	T, T7	—	—	—	—	—	—	—	—	—	—	—	—	—	—	—	
NU 315 E	M	T, T7	NU	NJ	NUP	—	86	86	92	97	106	149	—	—	2	2	3.73	
NU 2315 E*	M	T, T7	—	—	—	—	—	—	—	—	—	—	—	—	—	—	—	
NU 2315 E	M	T, T7	NU	NJ	NUP	—	86	86	92	97	106	149	—	—	2	2	4.86	
NU 415	W	M	NU	NJ	—	N	NF	88	88	102	107	118	177	177	164	2.5	2.5	6.27

Notes (3) If axial loads are applied, increase d_a and reduce D_a from the values listed above.

(4) d_b (max.) are values for adjusting rings for NU, NJ Types.

(5) The limiting speeds (mechanical) in the bearing tables are the value for the standard cage type.

Remark The bearings denoted by an asterisk (*) are NSKHPS Cylindrical roller bearings.

Single-Row Cylindrical Roller Bearings

Bore Diameter 80 – 90 mm

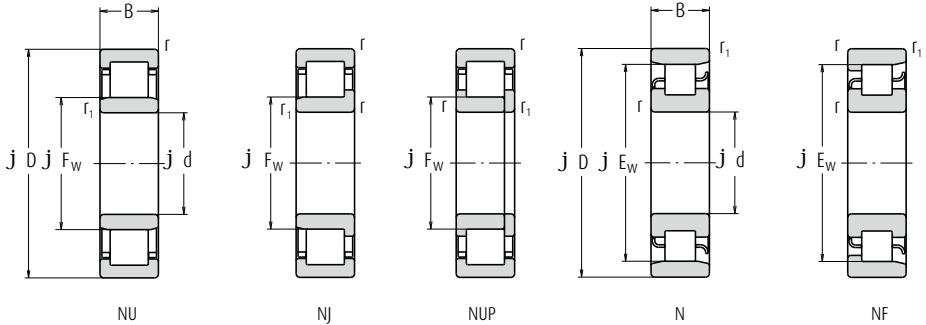

d	Boundary Dimensions (mm)						Basic Load Ratings (N)		Speeds (min ⁻¹)			
	D	B	r min.	r ₁ min.	F _w	E _w	C _r	C _{0r}	Thermal Reference Speed	Limiting Speeds		
										Mechanical (°)	Grease	
80	125	22	1.1	1.0	91.5	113.5	72 500	90 500	6 000	—	5 300	
	140	26	2.0	2.0	—	125.3	106 000	122 000	5 600	—	3 600	
	140	26	2.0	2.0	95.3	—	160 000	167 000	5 000	8 000	4 500	
	140	26	2.0	2.0	95.3	—	139 000	167 000	5 000	8 000	4 500	
	140	33	2.0	2.0	95.3	—	214 000	243 000	5 000	7 100	4 000	
	140	33	2.0	2.0	95.3	—	186 000	243 000	5 000	7 100	4 000	
	170	39	2.1	2.1	—	147	190 000	207 000	4 800	—	2 800	
	170	39	2.1	2.1	101.0	—	289 000	282 000	4 300	7 100	3 600	
	170	39	2.1	2.1	101.0	—	256 000	282 000	4 300	7 100	3 600	
	170	58	2.1	2.1	101.0	—	400 000	430 000	4 500	6 300	3 200	
	170	58	2.1	2.1	101.0	—	355 000	430 000	4 500	6 300	3 200	
	200	48	3.0	3.0	110.0	170	299 000	315 000	4 000	—	2 600	
	85	130	22	1.1	1.0	96.5	118.5	74 500	95 500	5 600	—	5 000
		150	28	2.0	2.0	—	133.8	120 000	140 000	5 300	—	3 400
		150	28	2.0	2.0	100.5	—	192 000	199 000	4 800	7 500	4 300
		150	28	2.0	2.0	100.5	—	167 000	199 000	4 800	7 500	4 300
150		36	2.0	2.0	100.5	—	250 000	279 000	4 800	6 700	3 800	
150		36	2.0	2.0	100.5	—	217 000	279 000	4 800	6 700	3 800	
180		41	3.0	3.0	—	156	225 000	247 000	4 500	—	2 600	
180		41	3.0	3.0	108.0	—	212 000	228 000	4 800	—	2 600	
180		41	3.0	3.0	108.0	—	360 000	330 000	4 000	6 700	3 400	
180		60	3.0	3.0	108.0	—	485 000	485 000	4 300	6 000	3 000	
210		52	4.0	4.0	113.0	177	335 000	350 000	4 000	—	3 000	
90		140	24	1.5	1.1	103.0	127	88 000	114 000	5 300	—	4 500
	160	30	2.0	2.0	—	143	152 000	178 000	5 000	—	3 200	
	160	30	2.0	2.0	107.0	—	205 000	217 000	4 800	7 100	4 000	
	160	30	2.0	2.0	107.0	—	182 000	217 000	4 800	7 100	4 000	
	160	40	2.0	2.0	107.0	—	274 000	315 000	4 800	6 300	3 600	
	160	40	2.0	2.0	107.0	—	242 000	315 000	4 800	6 300	3 600	
	190	43	3.0	3.0	—	165	240 000	265 000	4 500	—	2 600	
	190	43	3.0	3.0	115.0	—	240 000	265 000	4 500	—	2 600	
	190	43	3.0	3.0	113.5	—	390 000	355 000	4 000	6 300	3 200	
	190	64	3.0	3.0	113.5	—	535 000	535 000	4 000	5 600	2 800	
	225	54	4.0	4.0	123.5	191.5	375 000	400 000	3 600	—	2 800	

- Notes**
- (1) (M) in the column of cage symbols are usually omitted from the bearing number.
 - (2) When L-Shaped thrust collars (See section for L-Shaped Thrust Collars starting on pages B174 and B175) are used, the bearings become the NH type.

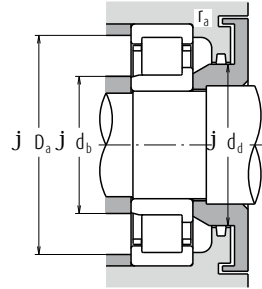
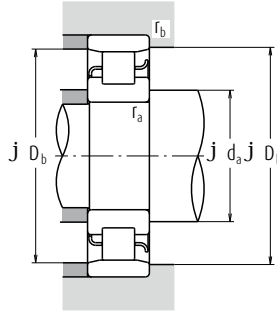
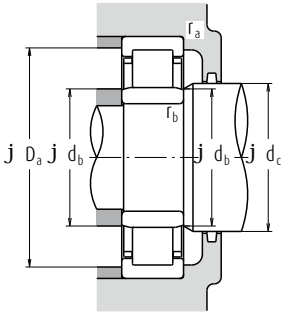

Bearing Numbers							Abutment and Fillet Dimensions (mm)										Mass (kg)		
Cage symbol (1)	NU	(2) NJ	NUP	N	NF	d _c (3) min.	d _b min.	d _b (4) max.	d _c min.	d _d min.	D _a (3) max.	D _b max.	D _b min.	r _a max.	r _b max.	approx.			
																	Standard option	NU	NJ
NU 1016	(M)	—	NU	—	NUP	N	—	86.5	85	90	94	—	118.5	120	115	1	1	0.969	
N 216	W	M	—	—	—	N	NF	89	—	—	—	—	—	131	128	2	2	1.47	
NU 216 E*	M	T, T7	—	—	—	—	—	—	—	—	—	—	—	—	—	—	—	—	
NU 216 E	M	T, T7	NU	NJ	NUP	—	—	89	89	92	97	104	131	—	—	2	2	1.7	
NU 2216 E*	M	T, T7	—	—	—	—	—	—	—	—	—	—	—	—	—	—	—	—	
NU 2216 E	M	T, T7	NU	NJ	NUP	—	—	89	89	92	97	104	131	—	—	2	2	1.96	
N 316	W	M	—	—	—	N	NF	91	—	—	—	—	—	159	150	2	2	3.85	
NU 316 E*	M	T, T7	—	—	—	—	—	—	—	—	—	—	—	—	—	—	—	—	
NU 316 E	M	T, T7	NU	NJ	NUP	—	—	91	91	98	105	114	159	—	—	2	2	4.45	
NU 2316 E*	M	T, T7	—	—	—	—	—	—	—	—	—	—	—	—	—	—	—	—	
NU 2316 E	M	T, T7	NU	NJ	NUP	—	—	91	91	98	105	114	159	—	—	2	2	5.73	
NU 416	W	M	NU	NJ	—	N	NF	93	93	107	112	124	187	187	173	2.5	2.5	7.36	
NU 1017	(M)	—	NU	—	—	N	—	91.5	90	95	99	—	123.5	125	120	1	1	1.01	
N 217	W	M	—	—	—	N	NF	94	—	—	—	—	—	—	141	137	2	2	1.87
NU 217 E*	M	T, T7	—	—	—	—	—	—	—	—	—	—	—	—	—	—	—	—	
NU 217 E	M	T, T7	NU	NJ	NUP	—	—	94	94	98	104	110	141	—	—	2	2	2.11	
NU 2217 E*	M	T, T7	—	—	—	—	—	—	—	—	—	—	—	—	—	—	—	—	
NU 2217 E	M	T, T7	NU	NJ	NUP	—	—	94	94	98	104	110	141	—	—	2	2	2.44	
N 317	W	M	—	—	—	N	NF	98	—	—	—	—	—	167	159	2.5	2.5	4.53	
NU 317	W	N	NU	NJ	NUP	—	—	98	98	105	110	119	167	—	—	2.5	2.5	4.6	
NU 317 E*	M	T, T7	NU	NJ	NUP	—	—	98	98	105	110	119	167	—	—	2.5	2.5	5.26	
NU 2317 E*	M	T, T7	NU	NJ	NUP	—	—	98	98	105	110	119	167	—	—	2.5	2.5	6.77	
NU 417	M	—	NU	NJ	—	N	NF	101	101	110	115	128	194	194	180	3	3	9.56	
NU 1018	(M)	—	NU	—	NUP	N	—	98	96.5	101	106	—	132	133.5	129	1.5	1	1.35	
N 218	W	M	—	—	—	N	NF	99	—	—	—	—	—	151	146	2	2	2.31	
NU 218 E*	M	T, T7	—	—	—	—	—	—	—	—	—	—	—	—	—	—	—	—	
NU 218 E	M	T, T7	NU	NJ	NUP	—	—	99	99	104	109	116	151	—	—	2	2	2.6	
NU 2218 E*	M	T, T7	—	—	—	—	—	—	—	—	—	—	—	—	—	—	—	—	
NU 2218 E	M	T, T7	NU	NJ	NUP	—	—	99	99	104	109	116	151	—	—	2	2	3.11	
N 318	W	M	—	—	—	N	NF	103	—	—	—	—	—	177	168	2.5	2.5	5.31	
NU 318	W	M	NU	NJ	NUP	—	—	103	103	112	117	127	177	—	—	2.5	2.5	5.38	
NU 318 E*	M	T, T7	NU	NJ	NUP	—	—	103	103	111	117	127	177	—	—	2.5	2.5	6.1	
NU 2318 E*	M	T, T7	NU	NJ	NUP	—	—	103	103	111	117	127	177	—	—	2.5	2.5	7.9	
NU 418	M	—	NU	NJ	—	N	NF	106	106	120	125	139	209	209	196	3	3	11.5	

Notes (3) If axial loads are applied, increase d_a and reduce D_a from the values listed above.

(4) d_b (max.) are values for adjusting rings for NU, NJ Types.

(5) The limiting speeds (mechanical) in the bearing tables are the value for the standard cage type.

Remark The bearings denoted by an asterisk (*) are NSKHPS Cylindrical roller bearings.

Single-Row Cylindrical Roller Bearings

Bore Diameter 95 – 110 mm

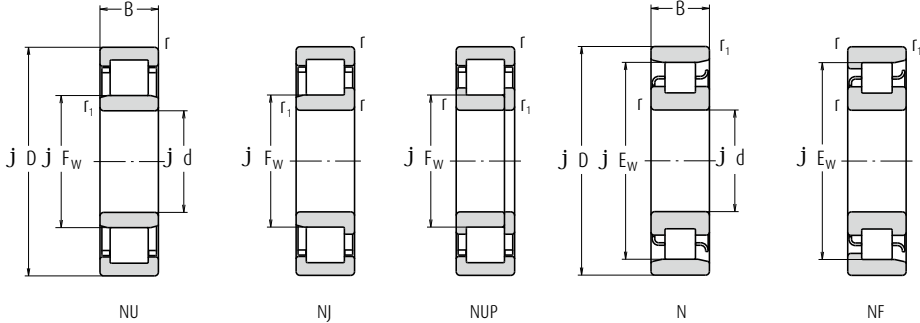

d	Boundary Dimensions (mm)						Basic Load Ratings (N)		Speeds (min ⁻¹)			
	D	B	r	r ₁	F _w	E _w	C _r	C _{0r}	Thermal Reference Speed	Limiting Speeds		
			min.	min.						Mechanical (°)	Grease	
95	145	24	1.5	1.1	108.0	132	90 500	120 000	5 000	—	4 300	
	170	32	2.1	2.1	—	151.5	166 000	196 000	4 800	—	3 000	
	170	32	2.1	2.1	112.5	—	249 000	265 000	4 300	6 700	3 800	
	170	32	2.1	2.1	112.5	—	220 000	265 000	4 300	6 700	3 800	
	170	43	2.1	2.1	112.5	—	325 000	370 000	4 500	6 000	3 400	
	170	43	2.1	2.1	112.5	—	286 000	370 000	4 500	6 000	3 400	
	200	45	3.0	3.0	—	173.5	259 000	289 000	4 300	—	2 400	
	200	45	3.0	3.0	121.5	—	259 000	289 000	4 300	—	2 400	
	200	45	3.0	3.0	121.5	—	410 000	385 000	3 800	6 000	3 000	
	200	67	3.0	3.0	121.5	—	565 000	585 000	3 800	5 300	2 600	
	240	55	4.0	4.0	133.5	201.5	400 000	445 000	3 200	—	2 600	
	100	150	24	1.5	1.1	113	137	93 000	126 000	4 800	—	4 300
		180	34	2.1	2.1	—	160	183 000	217 000	4 500	—	2 800
		180	34	2.1	2.1	119	—	305 000	305 000	4 300	6 300	3 600
180		46	2.1	2.1	119	—	410 000	445 000	4 300	5 600	3 200	
215		47	3.0	3.0	—	185.5	299 000	335 000	4 000	—	2 200	
215		47	3.0	3.0	129.5	—	299 000	335 000	4 000	—	2 200	
215		47	3.0	3.0	127.5	—	465 000	425 000	3 600	5 600	2 800	
215		73	3.0	3.0	127.5	—	700 000	715 000	3 400	5 600	2 400	
250		58	4.0	4.0	139	211	450 000	500 000	3 000	—	2 600	
105		160	26	2.0	1.1	119.5	145.5	109 000	149 000	4 500	—	4 000
	190	36	2.1	2.1	—	168.8	201 000	241 000	4 500	—	2 600	
	190	36	2.1	2.1	125	—	320 000	310 000	4 300	6 000	3 400	
	225	49	3.0	3.0	—	195	340 000	390 000	3 800	—	2 200	
	225	49	3.0	3.0	133	—	525 000	480 000	3 400	5 300	2 600	
	260	60	4.0	4.0	144.5	220.5	495 000	555 000	2 800	—	2 400	
110	170	28	2.0	1.1	125	155	131 000	174 000	4 500	—	3 800	
	200	38	2.1	2.1	—	178.5	229 000	272 000	4 300	—	2 600	
	200	38	2.1	2.1	132.5	—	360 000	365 000	4 000	5 600	3 200	
	200	53	2.1	2.1	132.5	—	470 000	515 000	4 000	5 000	2 800	
	240	50	3.0	3.0	—	207	380 000	435 000	3 400	—	2 000	
	240	50	3.0	3.0	143	—	555 000	525 000	3 200	5 000	2 600	
	240	80	3.0	3.0	143	—	830 000	880 000	3 000	4 500	2 200	
	280	65	4.0	4.0	155	—	550 000	620 000	2 600	—	2 200	

- Notes**
- (1) (M) in the column of cage symbols are usually omitted from the bearing number.
 - (2) When L-Shaped thrust collars (See section for L-Shaped Thrust Collars starting on page B175) are used, the bearings become the NH type.

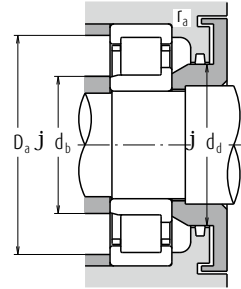
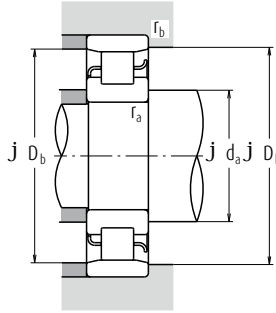
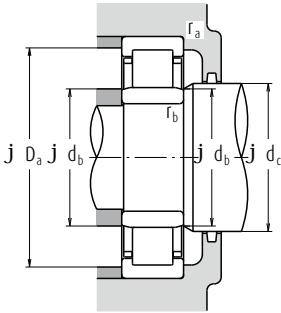

Bearing Numbers							Abutment and Fillet Dimensions (mm)										Mass (kg)	
Cage symbol (1)	NU	NJ	NUP	N	NF	d _a (2) min.	d _b min.	d _b (4) max.	d _c min.	d _d min.	D _a (3)		D _b		r _a max.	r _b max.	approx.	
											min.	max.	min.	max.				
NU 1019	(M)	—	NU	NJ	—	N	—	103	101.5	106	111	—	137	138.5	134	1.5	1	1.41
N 219	W	M	—	—	—	N	NF	106	—	—	—	—	—	159	155	2	2	2.79
NU 219 E*	M	T, T7	—	—	—	—	—	—	—	—	—	—	—	—	—	—	—	—
NU 219 E	M	T, T7	NU	NJ	NUP	—	—	106	106	110	116	123	159	—	—	2	2	3.17
NU 2219 E*	M	T, T7	—	—	—	—	—	—	—	—	—	—	—	—	—	—	—	—
NU 2219 E	M	T, T7	NU	NJ	NUP	—	—	106	106	110	116	123	159	—	—	2	2	3.81
N 319	W	M	—	—	—	N	NF	108	—	—	—	—	—	187	177	2.5	2.5	6.09
NU 319	W	M	NU	NJ	NUP	—	—	108	108	118	124	134	187	—	—	2.5	2.5	6.23
NU 319 E*	M	T, T7	NU	NJ	NUP	—	—	108	108	118	124	134	187	—	—	2.5	2.5	7.13
NU 2319 E*	M	T, T7	NU	NJ	NUP	—	—	108	108	118	124	134	187	—	—	2.5	2.5	9.21
NU 419	M	—	NU	NJ	NUP	—	NF	111	111	130	136	149	224	224	206	3	3	13.6
NU 1020	(M)	—	NU	NJ	NUP	N	—	108	106.5	111	116	—	142	143.5	139	1.5	1	1.47
N 220	W	M	—	—	—	N	NF	111	—	—	—	—	—	169	163	2	2	3.36
NU 220 E*	M	T, T7	NU	NJ	NUP	—	—	111	111	116	122	130	169	—	—	2	2	3.81
NU 2220 E*	M	T, T7	NU	NJ	NUP	—	—	111	111	116	122	130	169	—	—	2	2	4.69
N 320	W	M	—	—	—	N	NF	113	—	—	—	—	—	202	190	2.5	2.5	7.59
NU 320	W	M	NU	NJ	NUP	—	—	113	113	126	132	143	202	—	—	2.5	2.5	7.69
NU 320 E*	M	T, T7	NU	NJ	NUP	—	—	113	113	124	132	143	202	—	—	2.5	2.5	8.63
NU 2320 E*	M	T, T7	NU	NJ	NUP	—	—	113	113	124	132	143	202	—	—	2.5	2.5	11.8
NU 420	M	—	NU	NJ	—	N	NF	116	116	135	141	156	234	234	215	3	3	15.5
NU 1021	(M)	—	NU	—	—	N	NF	114	111.5	118	122	—	151	153.5	147	2	1	1.83
N 221	W	M	—	—	—	N	NF	116	—	—	—	—	—	179	172	2	2	4.0
NU 221 E*	M	—	NU	NJ	NUP	—	—	116	116	121	129	137	179	—	—	2	2	4.58
N 321	W	M	—	—	—	N	NF	118	—	—	—	—	—	212	199	2.5	2.5	8.69
NU 321 E*	M	—	NU	NJ	NUP	—	—	118	118	131	137	149	212	—	—	2.5	2.5	9.84
NU 421	M	—	NU	NJ	—	N	NF	121	121	141	147	162	244	244	225	3	3	17.3
NU 1022	(M)	—	NU	NJ	—	N	NF	119	116.5	123	128	—	161	163.5	157	2	1	2.27
N 222	W	M	—	—	—	N	NF	121	—	—	—	—	—	189	182	2	2	4.64
NU 222 E*	M	T, T7	NU	NJ	NUP	—	—	121	121	129	135	144	189	—	—	2	2	5.37
NU 2222 E*	M	—	NU	NJ	NUP	—	—	121	121	129	135	144	189	—	—	2	2	7.65
N 322	W	M	—	—	—	N	NF	123	—	—	—	—	—	227	211	2.5	2.5	10.3
NU 322 E*	M	—	NU	NJ	NUP	—	—	123	123	139	145	158	227	—	—	2.5	2.5	11.8
NU 2322 E*	M	T, T7	NU	NJ	—	—	—	123	123	139	145	158	227	—	—	2.5	2.5	18.8
NU 422	M	—	NU	NJ	—	—	—	126	126	151	157	173	264	—	—	3	3	22.1

- Notes**
- (3) If axial loads are applied, increase d_a and reduce D_a from the values listed above.
 - (4) d_b (max.) are values for adjusting rings for NU, NJ Types.
 - (5) The limiting speeds (mechanical) in the bearing tables are the value for the standard cage type.

Remark The bearings denoted by an asterisk (*) are NSKHPS Cylindrical roller bearings.

Single-Row Cylindrical Roller Bearings

Bore Diameter 120 – 150 mm

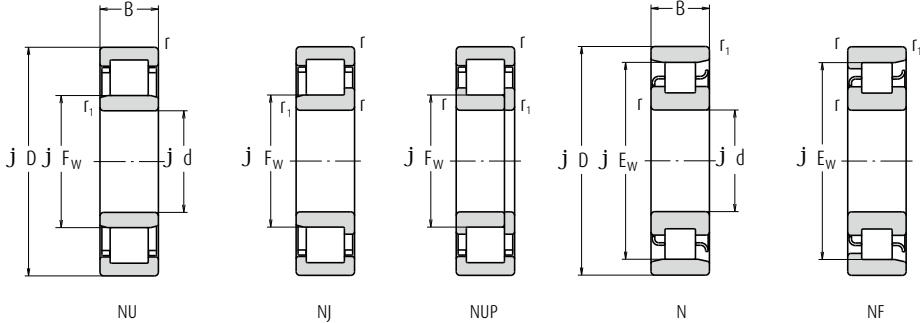

d	Boundary Dimensions (mm)						Basic Load Ratings (N)		Thermal Reference Speed	Speeds (min ⁻¹)		
	D	B	r min.	r ₁ min.	F _w	E _w	C _r	C _{0r}		Mechanical (1)	Grease	
120	180	28	2.0	1.1	135	165	139 000	191 000	4 000	—	3 400	
	215	40	2.1	2.1	—	191.5	260 000	320 000	4 000	—	2 400	
	215	40	2.1	2.1	143.5	—	410 000	420 000	3 600	5 300	3 000	
	215	58	2.1	2.1	143.5	—	555 000	620 000	3 600	4 800	2 600	
	260	55	3.0	3.0	—	226	450 000	510 000	3 000	—	1 800	
	260	55	3.0	3.0	154	—	650 000	610 000	2 800	4 800	2 200	
	260	86	3.0	3.0	154	—	975 000	1 030 000	2 600	4 300	2 000	
	310	72	5.0	5.0	170	260	675 000	770 000	2 400	—	2 000	
	130	200	33	2.0	1.1	148	182	172 000	238 000	4 000	—	3 200
		230	40	3.0	3.0	—	204	270 000	340 000	3 800	—	2 200
230		40	3.0	3.0	153.5	—	445 000	455 000	3 400	5 000	2 600	
230		64	3.0	3.0	153.5	—	650 000	735 000	3 400	4 500	2 400	
280		58	4.0	4.0	—	243	500 000	570 000	2 800	—	2 200	
280		58	4.0	4.0	167	—	760 000	735 000	2 600	4 300	2 200	
280		93	4.0	4.0	167	—	1 130 000	1 230 000	2 400	3 800	1 900	
340		78	5.0	5.0	185	285	825 000	955 000	2 000	—	1 800	
140		210	33	2.0	1.1	158	192	176 000	250 000	3 800	—	3 000
		250	42	3.0	3.0	—	221	297 000	375 000	3 400	—	2 000
	250	42	3.0	3.0	169	—	485 000	515 000	3 200	4 500	2 400	
	250	68	3.0	3.0	169	—	675 000	790 000	3 200	4 000	2 200	
	300	62	4.0	4.0	—	260	550 000	640 000	2 600	—	2 000	
	300	62	4.0	4.0	180	—	815 000	795 000	2 400	4 000	2 000	
	300	102	4.0	4.0	180	—	1 250 000	1 380 000	2 200	2 600	1 700	
	360	82	5.0	5.0	198	302	875 000	1 020 000	1 900	—	1 700	
	150	225	35	2.1	1.5	169.5	205.5	202 000	294 000	3 600	—	2 800
		270	45	3.0	3.0	—	238	360 000	465 000	3 000	—	1 800
270		45	3.0	3.0	182	—	550 000	595 000	2 800	4 300	2 200	
270		73	3.0	3.0	182	—	780 000	930 000	2 800	3 800	2 000	
320		65	4.0	4.0	—	277	665 000	805 000	2 200	—	1 800	
320		65	4.0	4.0	193	—	930 000	920 000	2 200	3 800	1 800	
320		108	4.0	4.0	193	—	1 430 000	1 600 000	2 000	2 400	1 600	
380		85	5.0	5.0	213	—	930 000	1 120 000	1 700	—	1 600	

- Notes**
- (1) (M) in the column of cage symbols are usually omitted from the bearing number.
 - (2) When L-Shaped thrust collars (See section for L-Shaped Thrust Collars starting on page B175) are used, the bearings become the NH type.

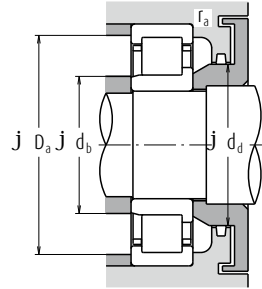
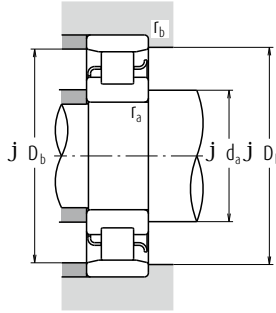
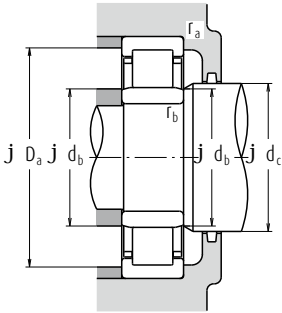

Bearing Numbers							Abutment and Fillet Dimensions (mm)										Mass (kg)	
Cage symbol (1) Standard option	NU	(2) NJ	NUP	N	NF	d _a (3) min.	d _b min.	d _b (4) max.	d _c min.	d _d min.	D _a (3) max.	D _b max.	D _b min.	r _a max.	r _b max.	approx.		
																	(1) M	(1) M
NU 1024	(M)	—	NU	NJ	NUP	N	—	129	126.5	133	138	—	171	173.5	167	2	1	2.43
N 224	W	M	—	—	—	N	NF	131	—	—	—	—	204	196	2	2	5.63	
NU 224 E*	M	—	NU	NJ	NUP	—	—	131	131	140	146	156	204	—	—	2	2	6.43
NU 2224 E*	M	—	NU	NJ	NUP	—	—	131	131	140	146	156	204	—	—	2	2	9.51
N 324	W	M	—	—	—	N	NF	133	—	—	—	—	247	230	2.5	2.5	12.9	
NU 324 E*	M	—	NU	NJ	NUP	—	—	133	133	150	156	171	247	—	—	2.5	2.5	15
NU 2324 E*	M	—	NU	NJ	NUP	—	—	133	133	150	156	171	247	—	—	2.5	2.5	25
NU 424	M	—	NU	NJ	NUP	N	—	140	140	166	172	190	290	290	266	4	4	30.2
NU 1026	(M)	—	NU	NJ	—	N	NF	139	136.5	146	151	—	191	193.5	184	2	1	3.66
N 226	W	M	—	—	—	N	NF	143	—	—	—	—	217	208	2.5	2.5	6.48	
NU 226 E*	M	T, T7	NU	NJ	NUP	—	—	143	143	150	158	168	217	—	—	2.5	2.5	8.03
NU 2226 E*	M	—	NU	NJ	NUP	—	—	143	143	150	158	168	217	—	—	2.5	2.5	9.44
N 326	M	—	—	—	—	N	NF	146	—	—	—	—	264	247.5	3	3	17.7	
NU 326 E*	M	—	NU	NJ	NUP	—	—	146	146	163	169	184	264	—	—	3	3	18.7
NU 2326 E*	M	—	NU	NJ	NUP	—	—	146	146	163	169	184	264	—	—	3	3	30
NU 426	M	—	NU	NJ	—	—	NF	150	150	180	187	208	320	320	291	4	4	39.6
NU 1028	(M)	—	NU	NJ	NUP	N	—	149	146.5	156	161	—	201	203.5	194	2	1	3.87
N 228	W	M	—	—	—	N	NF	153	—	—	—	—	237	225	2.5	2.5	8.08	
NU 228 E*	M	—	NU	NJ	NUP	—	—	153	153	165	171	182	237	—	—	2.5	2.5	9.38
NU 2228 E*	M	—	NU	NJ	NUP	—	—	153	153	165	171	182	237	—	—	2.5	2.5	15.2
N 328	M	—	—	—	—	N	NF	156	—	—	—	—	284	266	3	3	21.7	
NU 328 E*	M	—	NU	NJ	NUP	—	—	156	156	176	182	198	284	—	—	3	3	22.8
NU 2328 E*	M	—	NU	NJ	NUP	—	—	156	156	176	182	198	284	—	—	3	3	37.7
NU 428	M	—	NU	NJ	—	N	—	160	160	193	200	222	340	340	308	4	4	46.4
NU 1030	(M)	—	NU	NJ	—	N	NF	161	158	167	173	—	214	217	208	2	1.5	4.77
N 230	W	M	—	—	—	N	NF	163	—	—	—	—	—	257	242	2.5	2.5	10.4
NU 230 E*	M	—	NU	NJ	NUP	—	—	163	163	177	184	196	257	—	—	2.5	2.5	11.9
NU 2230 E*	M	—	NU	NJ	NUP	—	—	163	163	177	184	196	257	—	—	2.5	2.5	19.3
N 330	M	—	—	—	—	N	NF	166	—	—	—	—	304	283	3	3	25.8	
NU 330 E*	M	—	NU	NJ	NUP	—	—	166	166	188	195	213	304	—	—	3	3	27.1
NU 2330 E*	M	—	NU	NJ	NUP	—	—	166	166	188	195	213	304	—	—	3	3	45.1
NU 430	M	—	NU	NJ	—	—	—	170	170	208	216	237	360	—	—	4	4	55.8

- Notes**
- (3) If axial loads are applied, increase d_a and reduce D_a from the values listed above.
 - (4) d_b (max.) are values for adjusting rings for NU, NJ Types.
 - (5) The limiting speeds (mechanical) in the bearing tables are the value for the standard cage type.

Remark The bearings denoted by an asterisk (*) are NSKHPS Cylindrical roller bearings.

Single-Row Cylindrical Roller Bearings

Bore Diameter 160 - 190 mm

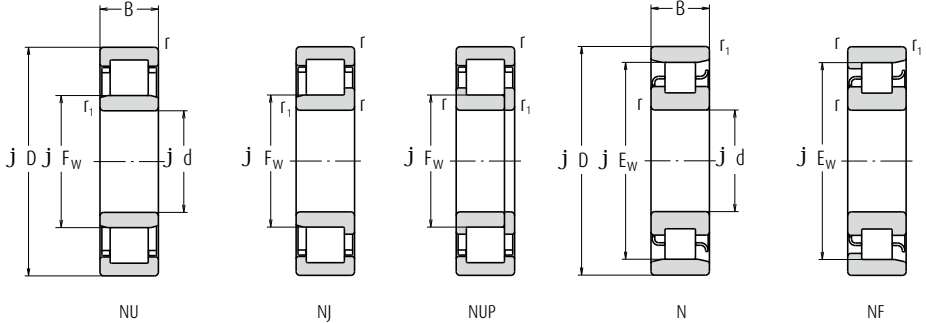

d	Boundary Dimensions (mm)						Basic Load Ratings (N)		Speeds (min ⁻¹)		
	D	B	r min.	r ₁ min.	F _w	E _w	C _r	C _{0r}	Thermal Reference Speed	Limiting Speeds	
										Mechanical (°)	Grease
160	240	38	2.1	1.5	180	220	238 000	340 000	3 400	—	2 600
	290	48	3.0	3.0	—	255	430 000	570 000	2 800	—	2 200
	290	48	3.0	3.0	195	—	615 000	665 000	2 600	4 000	2 200
	290	80	3.0	3.0	193	—	995 000	1 190 000	2 400	3 600	1 900
	340	68	4.0	4.0	—	292	700 000	875 000	2 000	—	1 700
	340	68	4.0	4.0	204	—	1 060 000	1 050 000	1 900	3 600	1 700
340	114	4.0	4.0	204	—	1 310 000	1 820 000	1 800	2 400	1 500	
170	260	42	2.1	2.1	193	237	287 000	415 000	3 200	—	2 400
	310	52	4	4	—	272	475 000	635 000	2 600	—	2 000
	310	52	4	4	207	—	740 000	800 000	2 400	3 800	2 000
	310	86	4	4	205	—	1 140 000	1 330 000	2 200	3 200	1 800
	360	72	4	4	—	310	795 000	1 010 000	1 900	—	1 600
	360	72	4	4	218	—	930 000	1 150 000	1 800	3 400	1 600
360	120	4	4	216	—	1 490 000	2 070 000	1 600	2 200	1 400	
180	280	46	2.1	2.1	205	255	355 000	510 000	3 000	—	2 200
	320	52	4	4	—	282	495 000	675 000	2 400	—	1 900
	320	52	4	4	217	—	770 000	850 000	2 200	3 600	1 900
	320	86	4	4	215	—	1 240 000	1 510 000	2 000	3 200	1 700
	380	75	4	4	—	328	905 000	1 150 000	1 700	—	1 500
	380	75	4	4	231	—	985 000	1 230 000	1 700	2 800	1 500
380	126	4	4	227	—	1 560 000	2 220 000	1 500	2 000	1 300	
190	290	46	2.1	2.1	215	265	365 000	535 000	2 800	—	2 000
	340	55	4	4	—	299	555 000	770 000	2 200	—	1 800
	340	55	4	4	230	—	885 000	955 000	2 000	3 400	1 800
	340	92	4	4	228	—	1 360 000	1 670 000	1 900	3 000	1 600
	400	78	5	5	—	345	975 000	1 260 000	1 600	—	1 400
	400	78	5	5	245	—	1 060 000	1 340 000	1 600	2 600	1 400
400	132	5	5	240	—	1 770 000	2 520 000	1 400	2 000	1 300	

- Notes**
- (1) (M) in the column of cage symbols are usually omitted from the bearing number.
 - (2) When L-Shaped thrust collars (See section for L-Shaped Thrust Collars starting on page B175) are used, the bearings become the NH type.

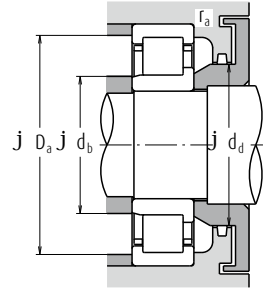
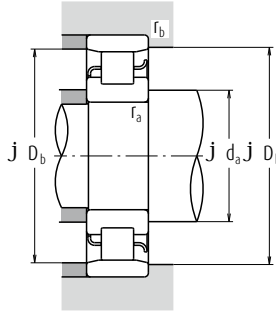
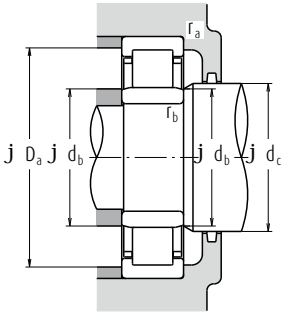

Bearing Numbers								Abutment and Fillet Dimensions (mm)								Mass (kg)		
Cage symbol (1) Standard option	NU	(2) NJ	NUP	N	NF	d _a (3) min.	d _b min.	d _b (4) max.	d _c min.	d _d min.	D _a (3) max.	D _b max.	D _b min.	r _a max.	r _b max.	approx.		
NU 1032	(M)	—	NU	NJ	—	N	NF	171	168	178	184	—	229	232	222	2	1.5	5.81
N 232	M	—	—	—	—	N	NF	173	—	—	—	—	277	261	2.5	2.5	14.1	
NU 232 E*	M	—	NU	NJ	NUP	—	—	173	173	190	197	210	277	—	—	2.5	2.5	14.7
NU 2232 E*	M	—	NU	NJ	NUP	—	—	173	173	188	197	210	277	—	—	2.5	2.5	24.5
N 332	M	—	—	—	—	N	—	176	—	—	—	—	324	298	3	3	30.8	
NU 332 E*	M	—	NU	NJ	NUP	—	—	176	176	199	211	228	324	—	—	3	3	32.1
NU 2332 E	M	—	NU	NJ	NUP	—	—	176	176	199	211	228	324	—	—	3	3	53.9
NU 1034	(M)	—	NU	NJ	—	N	—	181	181	190	197	—	249	249	239	2	2	7.91
N 234	M	—	—	—	—	N	NF	186	—	—	—	—	294	278	3	3	17.4	
NU 234 E*	M	—	NU	NJ	NUP	—	—	186	186	202	211	223	294	—	—	3	3	18.3
NU 2234 E*	M	—	NU	NJ	NUP	—	—	186	186	200	211	223	294	—	—	3	3	29.9
N 334	M	—	—	—	—	N	NF	186	—	—	—	—	344	316	3	3	36.6	
NU 334 E	M	—	NU	NJ	NUP	—	—	186	186	213	223	241	344	—	—	3	3	37.9
NU 2334 E	M	—	NU	NJ	NUP	—	—	186	186	210	223	241	344	—	—	3	3	63.4
NU 1036	(M)	—	NU	NJ	—	N	NF	191	191	202	209	—	269	269	258	2	2	10.2
N 236	M	—	—	—	—	N	NF	196	—	—	—	—	304	288	3	3	18.1	
NU 236 E*	M	—	NU	NJ	NUP	—	—	196	196	212	221	233	304	—	—	3	3	19
NU 2236 E*	M	—	NU	NJ	NUP	—	—	196	196	210	221	233	304	—	—	3	3	31.4
N 336	M	—	—	—	—	N	NF	196	—	—	—	—	364	335	3	3	42.6	
NU 336 E	M	—	NU	NJ	NUP	—	—	196	196	226	235	255	364	—	—	3	3	44
NU 2336 E	M	—	NU	NJ	NUP	—	—	196	196	222	235	255	364	—	—	3	3	74.6
NU 1038	(M)	—	NU	NJ	—	N	—	201	201	212	219	—	279	279	268	2	2	10.7
N 238	M	—	—	—	—	N	NF	206	—	—	—	—	324	305	3	3	22	
NU 238 E*	M	—	NU	NJ	NUP	—	—	206	206	225	234	247	324	—	—	3	3	23
NU 2238 E*	M	—	NU	NJ	NUP	—	—	206	206	223	234	247	324	—	—	3	3	38.3
N 338	M	—	—	—	—	N	—	210	—	—	—	—	380	352	4	4	48.7	
NU 338 E	M	—	NU	NJ	NUP	—	—	210	210	240	248	268	380	—	—	4	4	50.6
NU 2338 E	M	—	NU	NJ	NUP	—	—	210	210	235	248	268	380	—	—	4	4	86.2

Notes (3) If axial loads are applied, increase d_a and reduce D_a from the values listed above.

(4) d_b (max.) are values for adjusting rings for NU, NJ Types.

(5) The limiting speeds (mechanical) in the bearing tables are the value for the standard cage type.

Remark The bearings denoted by an asterisk (*) are NSKPS Cylindrical roller bearings.

Single-Row Cylindrical Roller Bearings

Bore Diameter 200 – 320 mm

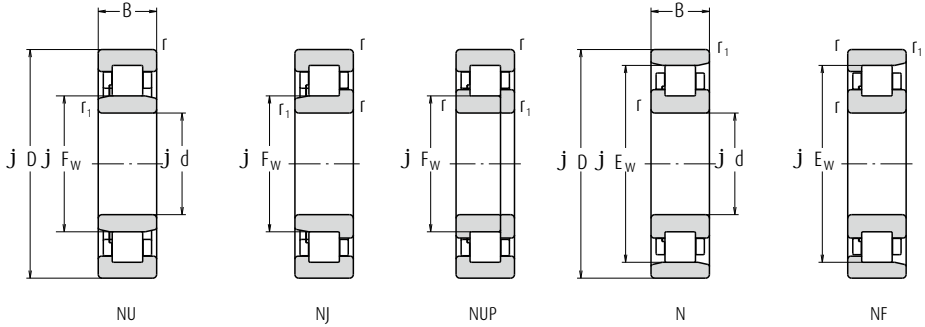

Boundary Dimensions (mm)							Basic Load Ratings (N)		Speeds (min ⁻¹)		
d	D	B	r min.	r ₁ min.	F _w	E _w	C _r	C _{0r}	Thermal Reference Speed	Limiting Speeds	
										Mechanical (°)	Grease
200	310	51	2.1	2.1	229	281	390 000	580 000	2 600	—	2 000
	360	58	4	4	—	316	620 000	865 000	2 000	—	1 700
	360	58	4	4	243	—	945 000	1 060 000	1 900	3 200	1 700
	360	98	4	4	241	—	1 500 000	1 870 000	1 800	2 200	1 500
	420	80	5	5	—	360	975 000	1 270 000	1 600	—	1 300
	420	80	5	5	258	—	1 140 000	1 450 000	1 500	2 600	1 200
220	420	138	5	5	253	—	1 910 000	2 760 000	1 300	1 900	1 200
	340	56	3	3	250	310	500 000	750 000	2 400	—	1 800
	400	65	4	4	—	350	760 000	1 080 000	1 800	—	1 500
	400	65	4	4	270	—	1 110 000	1 250 000	1 800	—	1 500
	400	108	4	4	270	—	1 140 000	1 810 000	1 700	—	1 300
	460	88	5	5	—	396	1 190 000	1 570 000	1 400	—	1 200
240	460	88	5	5	284	—	1 190 000	1 570 000	1 400	—	1 200
	360	56	3	3	270	330	530 000	820 000	2 200	—	1 600
	440	72	4	4	—	385	935 000	1 340 000	1 600	—	1 300
	440	72	4	4	295	—	935 000	1 340 000	1 600	—	1 300
	440	120	4	4	295	—	1 440 000	2 320 000	1 500	—	1 200
	500	95	5	5	—	430	1 360 000	1 820 000	1 200	—	1 100
260	500	95	5	5	310	—	1 360 000	1 820 000	1 200	—	1 100
	400	65	4	4	296	364	645 000	1 000 000	1 900	—	1 500
	480	80	5	5	—	420	1 100 000	1 580 000	1 500	—	1 200
	480	80	5	5	320	—	1 100 000	1 580 000	1 500	—	1 200
	480	130	5	5	320	—	1 710 000	2 770 000	1 300	—	1 100
	540	102	6	6	336	—	1 540 000	2 090 000	1 100	—	1 000
280	420	65	4	4	316	384	660 000	1 050 000	1 800	—	1 400
	500	80	5	5	—	440	1 140 000	1 680 000	1 300	—	1 100
	500	80	5	5	340	—	1 140 000	1 680 000	1 300	—	1 100
300	460	74	4	4	340	420	885 000	1 400 000	1 600	—	1 300
	540	85	5	5	364	—	1 400 000	2 070 000	1 200	—	1 100
320	480	74	4	4	360	440	905 000	1 470 000	1 500	—	1 200
	580	92	5	5	—	510	1 540 000	2 270 000	1 100	—	950
	580	92	5	5	390	—	1 540 000	2 270 000	1 100	—	950

- Notes**
- (1) (M) in the column of cage symbols are usually omitted from the bearing number.
 - (2) When L-Shaped thrust collars (See section for L-Shaped Thrust Collars starting on page B175) are used, the bearings become the NH type.

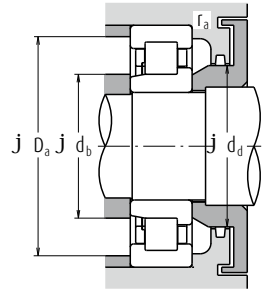
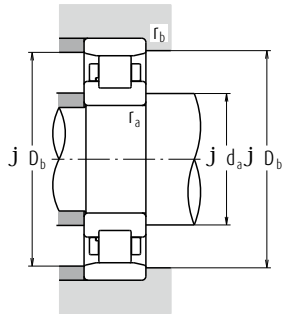
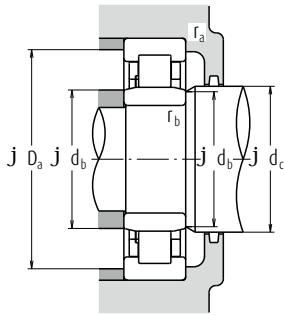

Bearing Numbers							Abutment and Fillet Dimensions (mm)								Mass (kg)			
Cage symbol (1) Standard option	NU	NJ	NUP	N	NF	d _c (³) min.	d _b min.	d _b (⁴) max.	d _c min.	d _d min.	D _a (³) max.	D _b max.	D _b min.	r _a max.	r _b max.	approx.		
																	NU	NJ
NU 1040	(M)	—	NU	NJ	—	N	NF	211	211	226	233	—	299	299	284	2	2	14
N 240	M	—	—	—	—	N	NF	216	—	—	—	—	344	323	3	3	26.2	
NU 240 E*	M	—	NU	NJ	NUP	—	—	216	216	238	247	261	344	—	3	3	27.4	
NU 2240 E*	M	—	NU	NJ	NUP	—	—	216	216	235	247	261	344	—	3	3	46.1	
N 340	M	—	—	—	—	N	NF	220	—	—	—	—	400	367	4	4	55.3	
NU 340 E	M	—	NU	NJ	NUP	—	—	220	220	252	263	283	400	—	4	4	57.1	
NU 2340 E	M	—	NU	NJ	NUP	—	—	220	220	247	263	283	400	—	4	4	99.3	
NU 1044	(M)	—	NU	NJ	—	N	—	233	233	247	254	—	327	327	313	2.5	2.5	18.2
N 244	M	—	—	—	—	N	NF	236	—	—	—	—	384	357	3	3	37	
NU 244 E*	M	—	NU	NJ	NUP	—	—	236	236	264	273	289	384	—	3	3	37.3	
NU 2244	M	—	NU	—	—	—	—	—	236	264	273	289	384	—	3	3	61.8	
N 344	M	—	—	—	—	N	—	240	—	—	—	—	440	403	4	4	72.8	
NU 344	M	—	NU	NJ	—	—	—	240	240	278	287	307	440	—	4	4	74.6	
NU 1048	(M)	—	NU	NJ	—	N	—	253	253	266	275	—	347	347	333	2.5	2.5	19.5
N 248	M	—	—	—	—	N	NF	256	—	—	—	—	424	392	3	3	49.6	
NU 248	M	—	NU	NJ	NUP	—	—	256	256	289	298	316	424	—	3	3	50.4	
NU 2248	M	—	NU	—	—	—	—	—	256	289	298	316	424	—	3	3	84.9	
N 348	M	—	—	—	—	N	—	260	—	—	—	—	480	438	4	4	92.3	
NU 348	M	—	NU	NJ	—	—	—	260	260	304	313	333	480	—	4	4	94.6	
NU 1052	(M)	—	NU	NJ	—	N	NF	276	276	292	300	—	384	384	367	3	3	29.1
N 252	M	—	—	—	—	N	—	280	—	—	—	—	460	428	4	4	66.2	
NU 252	M	—	NU	NJ	—	—	—	280	280	314	323	343	460	—	4	4	67.1	
NU 2252	M	—	NU	—	NUP	—	—	280	280	314	323	343	460	—	4	4	111	
NU 352	M	—	NU	NJ	—	—	—	286	286	330	339	359	514	—	5	5	118	
NU 1056	(M)	—	NU	NJ	NUP	N	NF	296	296	312	320	—	404	404	387	3	3	30.8
N 256	M	—	—	—	—	N	NF	300	—	—	—	—	480	448	4	4	69.6	
NU 256	M	—	NU	NJ	—	—	—	300	300	334	344	364	480	—	4	4	70.7	
NU 1060	(M)	—	NU	NJ	—	N	NF	316	316	336	344	—	444	444	424	3	3	43.7
NU 260	M	—	NU	NJ	—	—	—	320	320	358	368	391	520	—	4	4	89.2	
NU 1064	(M)	—	NU	—	—	N	NF	336	336	356	365	—	464	464	444	3	3	46.1
N 264	M	—	—	—	—	N	—	340	—	—	—	—	560	519	4	4	110	
NU 264	M	—	NU	NJ	—	—	—	340	340	384	394	420	560	—	4	4	112	

Notes (3) If axial loads are applied, increase d_a and reduce D_a from the values listed above.

(4) d_b (max.) are values for adjusting rings for NU, NJ Types.

(5) The limiting speeds (mechanical) in the bearing tables are the value for the standard cage type.

Remark The bearings denoted by an asterisk (*) are NSKPS Cylindrical roller bearings.

Single-Row Cylindrical Roller Bearings

Bore Diameter 340 – 500 mm

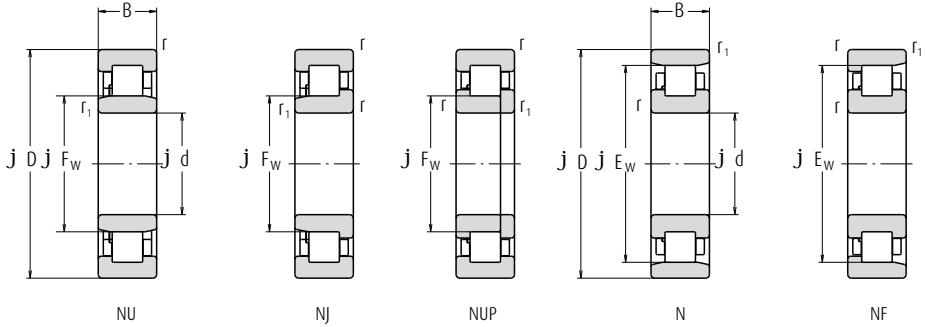

Boundary Dimensions (mm)							Basic Load Ratings (N)		Speeds (min ⁻¹)		
d	D	B	r min.	r ₁ min.	F _W	E _W	C _r	C _{0r}	Thermal Reference Speed	Limiting Speeds	
										Mechanical (°)	Grease
340	520	82	5	5	385	475	1 080 000	1 740 000	1 400	—	1 100
360	540	82	5	5	405	495	1 110 000	1 830 000	1 300	—	1 000
380	560	82	5	5	425	—	1 140 000	1 910 000	1 200	—	1 000
400	600	90	5	5	450	550	1 360 000	2 280 000	1 100	—	900
420	620	90	5	5	470	570	1 390 000	2 380 000	1 100	—	850
440	650	94	6	6	493	—	1 470 000	2 530 000	1 000	—	800
460	680	100	6	6	516	624	1 580 000	2 740 000	950	—	750
480	700	100	6	6	536	644	1 620 000	2 860 000	900	—	750
500	720	100	6	6	556	664	1 660 000	2 970 000	900	—	710

- Notes**
- (1) (M) in the column of cage symbols are usually omitted from the bearing number.
 - (2) When L-Shaped thrust collars (See section for L-Shaped Thrust Collars starting on page **B175**) are used, the bearings become the NH type.

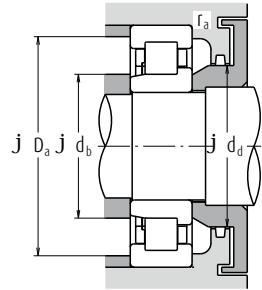
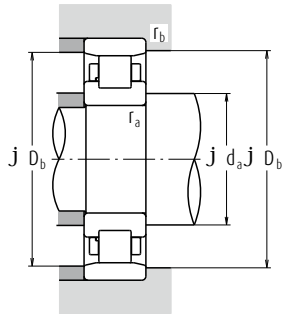
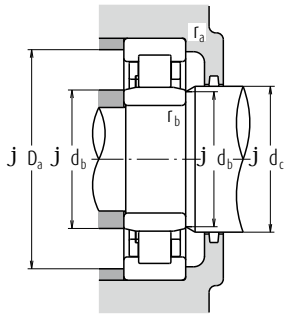

Bearing Numbers							Abutment and Fillet Dimensions (mm)								Mass (kg)			
Cage symbol (1) Standard option	NU	NJ	NUP	N	NF	d _a ⁽³⁾ min.	d _b min.	d _b ⁽⁴⁾ max.	d _c min.	d _d min.	D _a ⁽³⁾ max.	D _b max.	D _b min.	r _a max.	r _b max.	approx.		
																	—	—
NU 1068	(M)	—	NU	NJ	—	N	NF	360	360	381	390	—	500	500	479	4	4	61.8
NU 1072	(M)	—	NU	—	—	N	NF	380	380	400	410	—	520	520	499	4	4	64.6
NU 1076	(M)	—	NU	—	—	—	—	—	400	420	430	—	540	—	—	4	4	67.5
NU 1080	(M)	—	NU	—	NUP	N	—	420	420	445	455	—	580	580	554.5	4	4	88.2
NU 1084	(M)	—	NU	—	—	N	—	440	440	465	475	—	600	600	574.5	4	4	91.7
NU 1088	(M)	—	NU	—	—	—	—	—	466	488	498	—	624	—	—	5	5	105
NU 1092	(M)	—	NU	—	NUP	N	—	486	486	511	521	—	654	654	628.5	5	5	123
NU 1096	(M)	—	NU	NJ	—	N	—	506	506	531	541	—	674	674	654	5	5	127
NU10/500	(M)	—	NU	—	—	N	—	526	526	551	558	—	694	694	674	5	5	131

- Notes**
- (3) If axial loads are applied, increase d_a and reduce D_a from the values listed above.
 - (4) d_b (max.) are values for adjusting rings for NU, NJ Types.
 - (5) The limiting speeds (mechanical) in the bearing tables are the value for the standard cage type.

Cylindrical Roller Bearings

L-Shaped Thrust Collars Bore Diameter 20 – 85 mm

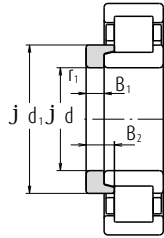

L-Shaped Thrust Collar

Boundary Dimensions (mm)					Thrust Collar Numbers	Mass (kg) approx.
d	d ₁	B ₁	B ₂	r ₁ min.		
20	30	3	6.75	0.6	HJ 204	0.012
	29.8	3	5.5	0.6	HJ 204 E	0.011
	30	3	7.5	0.6	HJ 2204	0.012
	29.8	3	6.5	0.6	HJ 2204 E	0.012
	31.7	4	7.5	0.6	HJ 304	0.017
	31.4	4	6.5	0.6	HJ 304 E	0.017
	31.8	4	8.5	0.6	HJ 2304	0.017
	31.4	4	7.5	0.6	HJ 2304 E	0.018
	34.8	3	6	0.6	HJ 205 E	0.014
	34.8	3	6.5	0.6	HJ 2205 E	0.014
25	38.2	4	7	1.1	HJ 305 E	0.025
	38.2	4	8	1.1	HJ 2305 E	0.026
	43.6	6	10.5	1.5	HJ 405	0.057
	41.3	4	7	0.6	HJ 206 E	0.025
	41.4	4	7.5	0.6	HJ 2206 E	0.025
	45.1	5	8.5	1.1	HJ 306 E	0.042
30	45.1	5	9.5	1.1	HJ 2306 E	0.043
	50.5	7	11.5	1.5	HJ 406	0.080
	48.2	4	7	0.6	HJ 207 E	0.033
	48.2	4	8.5	0.6	HJ 2207 E	0.035
	51.1	6	9.5	1.1	HJ 307 E	0.060
	51.1	6	11	1.1	HJ 2307 E	0.062
35	59	8	13	1.5	HJ 407	0.12
	54.1	5	8.5	1.1	HJ 208 E	0.049
	54.1	5	9	1.1	HJ 2208 E	0.050
	57.6	7	11	1.5	HJ 308 E	0.088
	57.7	7	12.5	1.5	HJ 2308 E	0.091
	64.8	8	13	2	HJ 408	0.14
40	59.1	5	8.5	1.1	HJ 209 E	0.055
	59.1	5	9	1.1	HJ 2209 E	0.055
	64.5	7	11.5	1.5	HJ 309 E	0.11
	64.5	7	13	1.5	HJ 2309 E	0.113
	71.7	8	13.5	2	HJ 409	0.175
45	64.1	5	9	1.1	HJ 210 E	0.061
	64.1	5	9	1.1	HJ 2210 E	0.061
	71.4	8	13	2	HJ 310 E	0.151
	71.4	8	14.5	2	HJ 2310 E	0.155
	78.8	9	14.5	2.1	HJ 410	0.23

Boundary Dimensions (mm)					Thrust Collar Numbers	Mass (kg) approx.
d	d ₁	B ₁	B ₂	r ₁ min.		
55	70.9	6	9.5	1.1	HJ 211 E	0.087
	70.9	6	10	1.1	HJ 2211 E	0.088
	77.6	9	14	2	HJ 311 E	0.195
	77.6	9	15.5	2	HJ 2311 E	0.20
	85.2	10	16.5	2.1	HJ 411	0.29
60	77.7	6	10	1.5	HJ 212 E	0.108
	77.7	6	10	1.5	HJ 2212 E	0.108
	84.5	9	14.5	2.1	HJ 312 E	0.231
	84.5	9	16	2.1	HJ 2312 E	0.237
65	91.8	10	16.5	2.1	HJ 412	0.34
	84.5	6	10	1.5	HJ 213 E	0.129
	84.5	6	10.5	1.5	HJ 2213 E	0.131
	90.6	10	15.5	2.1	HJ 313 E	0.288
	90.6	10	18	2.1	HJ 2313 E	0.298
70	98.5	11	18	2.1	HJ 413	0.42
	89.5	7	11	1.5	HJ 214 E	0.157
	89.5	7	11.5	1.5	HJ 2214 E	0.158
	97.5	10	15.5	2.1	HJ 314 E	0.33
	97.5	10	18.5	2.1	HJ 2314 E	0.345
75	110.5	12	20	3	HJ 414	0.605
	94.5	7	11	1.5	HJ 215 E	0.166
	94.5	7	11.5	1.5	HJ 2215 E	0.167
	104.2	11	16.5	2.1	HJ 315 E	0.41
	104.2	11	19.5	2.1	HJ 2315 E	0.43
80	116	13	21.5	3	HJ 415	0.71
	101.6	8	12.5	2	HJ 216 E	0.222
	101.6	8	12.5	2	HJ 2216 E	0.222
	110.6	11	17	2.1	HJ 316 E	0.46
	110.6	11	20	2.1	HJ 2316 E	0.48
85	122	13	22	3	HJ 416	0.78
	107.6	8	12.5	2	HJ 217 E	0.25
	107.6	8	13	2	HJ 2217 E	0.252
	117.9	12	18.5	3	HJ 317 E	0.575
	117.9	12	22	3	HJ 2317 E	0.595
126	14	24	4	HJ 417	0.88	

L-Shaped Thrust Collars Bore Diameter 90 – 320 mm

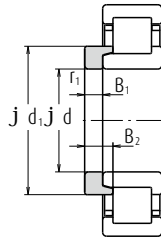

L-Shaped Thrust Collar

Boundary Dimensions (mm)					Thrust Collar Numbers	Mass (kg) approx.
d	d ₁	B ₁	B ₂	r ₁ min.		
90	114.3	9	14	2	HJ 218 E	0.32
	114.3	9	15	2	HJ 2218 E	0.325
	124.2	12	18.5	3	HJ 318 E	0.63
	124.2	12	22	3	HJ 2318 E	0.66
	137	14	24	4	HJ 418	1.05
95	120.6	9	14	2.1	HJ 219 E	0.355
	120.6	9	15.5	2.1	HJ 2219 E	0.365
	132.2	13	20.5	3	HJ 319 E	0.785
	132.2	13	24.5	3	HJ 2319 E	0.815
	147	15	25.5	4	HJ 419	1.3
100	127.5	10	15	2.1	HJ 220 E	0.44
	127.5	10	16	2.1	HJ 2220 E	0.45
	139.6	13	20.5	3	HJ 320 E	0.89
	139.6	13	23.5	3	HJ 2320 E	0.92
	153.5	16	27	4	HJ 420	1.5
105	145	13	20.5	3	HJ 321 E	0.97
	159.5	16	27	4	HJ 421	1.65
	141.7	11	17	2.1	HJ 222 E	0.62
110	141.7	11	19.5	2.1	HJ 2222 E	0.645
	155.8	14	22	3	HJ 322 E	1.21
	155.8	14	26.5	3	HJ 2322 E	1.27
	171	17	29.5	4	HJ 422	2.1
	153.4	11	17	2.1	HJ 224 E	0.71
120	153.4	11	20	2.1	HJ 2224 E	0.745
	168.6	14	22.5	3	HJ 324 E	1.41
	168.6	14	26	3	HJ 2324 E	1.46
	188	17	30.5	5	HJ 424	2.6
	164.2	11	17	3	HJ 226 E	0.79
130	164.2	11	21	3	HJ 2226 E	0.84
	182.3	14	23	4	HJ 326 E	1.65
	182.3	14	28	4	HJ 2326 E	1.73
	205	18	32	5	HJ 426	3.3
	180	11	18	3	HJ 228 E	0.99
140	180	11	23	3	HJ 2228 E	1.07
	196	15	25	4	HJ 328 E	2.04
	196	15	31	4	HJ 2328 E	2.14
	219	18	33	5	HJ 428	3.75

Boundary Dimensions (mm)					Thrust Collar Numbers	Mass (kg) approx.
d	d ₁	B ₁	B ₂	r ₁ min.		
150	193.7	12	19.5	3	HJ 230 E	1.26
	193.7	12	24.5	3	HJ 2230 E	1.35
	210	15	25	4	HJ 330 E	2.35
	210	15	31.5	4	HJ 2330 E	2.48
	234	20	36.5	5	HJ 430	4.7
160	207.3	12	20	3	HJ 232 E	1.48
	206.1	12	24.5	3	HJ 2232 E	1.55
	222	15	25	4	HJ 332 E	2.59
170	222.1	15	32	4	HJ 2332 E	2.76
	220.8	12	20	4	HJ 234 E	1.7
	219.5	12	24	4	HJ 2234 E	1.79
	238	16	33.5	4	HJ 2334 E	3.25
	230.8	12	20	4	HJ 236 E	1.79
180	229.5	12	24	4	HJ 2236 E	1.88
	252	17	35	4	HJ 2336 E	3.85
	244.5	13	21.5	4	HJ 238 E	2.19
	243.2	13	26.5	4	HJ 2238 E	2.31
	260.6	18	36.5	5	HJ 2338 E	4.45
200	258.2	14	23	4	HJ 240 E	2.65
	258	14	34	4	HJ 2240	2.6
	256.9	14	28	4	HJ 2240 E	2.78
	280	18	30	5	HJ 340 E	5.0
	220	286	15	27.5	4	HJ 244
240	286	15	36.5	4	HJ 2244	3.55
	307	20	36	5	HJ 344	7.05
	313	16	29.5	4	HJ 248	4.65
	313	16	38.5	4	HJ 2248	4.65
	334	22	39.5	5	HJ 348	8.2
260	340	18	33	5	HJ 252	6.2
	340	18	40.5	5	HJ 2252	6.2
	362	24	43	6	HJ 352	11.4
280	360	18	33	5	HJ 256	7.4
	300	387	20	34.5	5	HJ 260
320	415	21	37	5	HJ 264	11.3

Double-Row Cylindrical Roller Bearings

Bore Diameter 25 – 140 mm

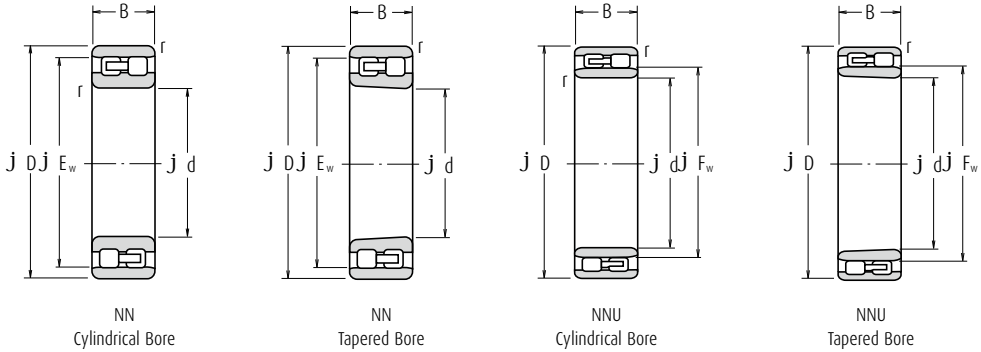

Boundary Dimensions (mm)						Basic Load Ratings (N)		Limiting Speeds (min ⁻¹)	
d	D	B	r min.	F _w	E _w	C _r	C _{0r}	Grease	Oil
25	47	16	0.6	—	41.3	25 800	30 000	14 000	17 000
30	55	19	1	—	48.5	31 000	37 000	12 000	14 000
35	62	20	1	—	55	39 500	50 000	10 000	12 000
40	68	21	1	—	61	43 500	55 500	9 000	11 000
45	75	23	1	—	67.5	52 000	68 500	8 500	10 000
50	80	23	1	—	72.5	53 000	72 500	7 500	9 000
55	90	26	1.1	—	81	69 500	96 500	6 700	8 000
60	95	26	1.1	—	86.1	73 500	106 000	6 300	7 500
65	100	26	1.1	—	91	77 000	116 000	6 000	7 100
70	110	30	1.1	—	100	97 500	148 000	5 600	6 700
75	115	30	1.1	—	105	96 500	149 000	5 300	6 300
80	125	34	1.1	—	113	119 000	186 000	4 800	6 000
85	130	34	1.1	—	118	125 000	201 000	4 500	5 600
90	140	37	1.5	—	127	143 000	228 000	4 300	5 000
95	145	37	1.5	—	132	150 000	246 000	4 000	5 000
100	140	40	1.1	112	—	155 000	295 000	4 000	5 000
	150	37	1.5	—	137	157 000	265 000	4 000	4 800
105	145	40	1.1	117	—	161 000	315 000	3 800	4 800
	160	41	2	—	146	198 000	320 000	3 800	4 500
110	150	40	1.1	122	—	167 000	335 000	3 600	4 500
	170	45	2	—	155	229 000	375 000	3 400	4 300
120	165	45	1.1	133.5	—	183 000	360 000	3 200	4 000
	180	46	2	—	165	239 000	405 000	3 200	3 800
130	180	50	1.5	144	—	274 000	545 000	3 000	3 800
	200	52	2	—	182	284 000	475 000	3 000	3 600
140	190	50	1.5	154	—	283 000	585 000	2 800	3 600
	210	53	2	—	192	298 000	515 000	2 800	3 400

Note (*) The suffix KR represents bearings with tapered bores (taper 1 : 12).

Remark Production of double-row cylindrical roller bearings is generally in the high precision classes (Class 5 or better).

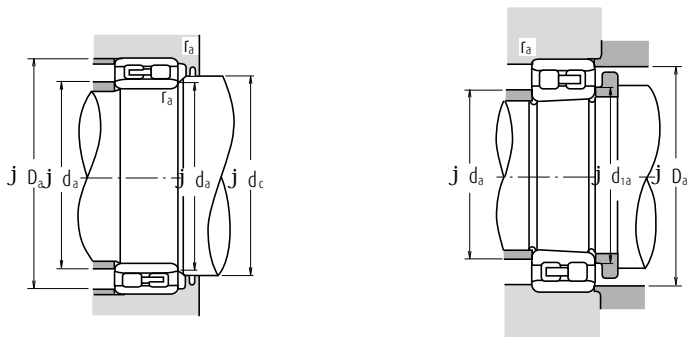

Bearing Numbers		Abutment and Fillet Dimensions (mm)							Mass (kg)
Cylindrical Bore	Tapered Bore (1)	$d_a^{(2)}$		d_{1a}	d_c	D_a		r_a	approx.
		min.	max.	min.	min.	min.	max.	max.	
NN 3005	NN 3005 K	29	—	29	—	43	42	0.6	0.127
NN 3006	NN 3006 K	35	—	36	—	50	50	1	0.198
NN 3007	NN 3007 K	40	—	41	—	57	56	1	0.258
NN 3008	NN 3008 K	45	—	46	—	63	62	1	0.309
NN 3009	NN 3009 K	50	—	51	—	70	69	1	0.407
NN 3010	NN 3010 K	55	—	56	—	75	74	1	0.436
NN 3011	NN 3011 K	61.5	—	62	—	83.5	83	1	0.647
NN 3012	NN 3012 K	66.5	—	67	—	88.5	88	1	0.693
NN 3013	NN 3013 K	71.5	—	72	—	93.5	93	1	0.741
NN 3014	NN 3014 K	76.5	—	77	—	103.5	102	1	1.06
NN 3015	NN 3015 K	81.5	—	82	—	108.5	107	1	1.11
NN 3016	NN 3016 K	86.5	—	87	—	118.5	115	1	1.54
NN 3017	NN 3017 K	91.5	—	92	—	123.5	120	1	1.63
NN 3018	NN 3018 K	98	—	99	—	132	129	1.5	2.09
NN 3019	NN 3019 K	103	—	104	—	137	134	1.5	2.19
NNU 4920	NNU 4920 K	106.5	111	108	115	133.5	—	1	1.9
NN 3020	NN 3020 K	108	—	109	—	142	139	1.5	2.28
NNU 4921	NNU 4921 K	111.5	116	113	120	138.5	—	1	1.99
NN 3021	NN 3021 K	114	—	115	—	151	148	2	2.88
NNU 4922	NNU 4922 K	116.5	121	118	125	143.5	—	1	2.07
NN 3022	NN 3022 K	119	—	121	—	161	157	2	3.71
NNU 4924	NNU 4924 K	126.5	133	128	137	158.5	—	1	2.85
NN 3024	NN 3024 K	129	—	131	—	171	167	2	4.04
NNU 4926	NNU 4926 K	138	143	140	148	172	—	1.5	3.85
NN 3026	NN 3026 K	139	—	141	—	191	185	2	5.88
NNU 4928	NNU 4928 K	148	153	150	158	182	—	1.5	4.08
NN 3028	NN 3028 K	149	—	151	—	201	195	2	6.34

Note (2) d_a (max.) are values for adjusting rings for the NNU Type.

Double-Row Cylindrical Roller Bearings

Bore Diameter 150 – 360 mm

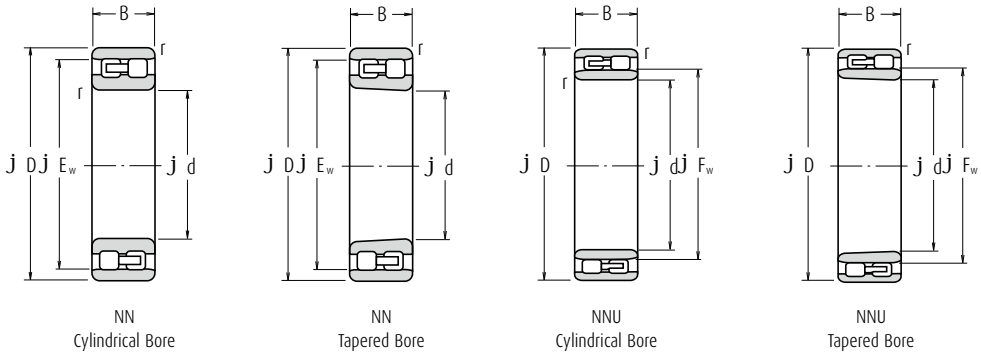

Boundary Dimensions (mm)						Basic Load Ratings (N)		Limiting Speeds (min ⁻¹)	
d	D	B	r min.	F _w	E _w	C _r	C _{0r}	Grease	Oil
150	210	60	2	167	—	350 000	715 000	2 600	3 200
	225	56	2.1	—	206	335 000	585 000	2 600	3 000
160	220	60	2	177	—	365 000	760 000	2 400	3 000
	240	60	2.1	—	219	375 000	660 000	2 400	2 800
170	230	60	2	187	—	375 000	805 000	2 400	2 800
	260	67	2.1	—	236	450 000	805 000	2 200	2 600
180	250	69	2	200	—	480 000	1 020 000	2 200	2 600
	280	74	2.1	—	255	565 000	995 000	2 000	2 400
190	260	69	2	211.5	—	485 000	1 060 000	2 000	2 600
	290	75	2.1	—	265	595 000	1 080 000	2 000	2 400
200	280	80	2.1	223	—	570 000	1 220 000	1 900	2 400
	310	82	2.1	—	282	655 000	1 170 000	1 800	2 200
220	300	80	2.1	243	—	600 000	1 330 000	1 700	2 200
	340	90	3	—	310	815 000	1 480 000	1 700	2 000
240	320	80	2.1	263	—	625 000	1 450 000	1 600	2 000
	360	92	3	—	330	855 000	1 600 000	1 500	1 800
260	360	100	2.1	289	—	935 000	2 100 000	1 400	1 800
	400	104	4	—	364	1 030 000	1 920 000	1 400	1 700
280	380	100	2.1	309	—	960 000	2 230 000	1 300	1 700
	420	106	4	—	384	1 080 000	2 080 000	1 300	1 500
300	420	118	3	336	—	1 230 000	2 870 000	1 200	1 500
	460	118	4	—	418	1 290 000	2 460 000	1 200	1 400
320	440	118	3	356	—	1 260 000	3 050 000	1 100	1 400
	480	121	4	—	438	1 350 000	2 670 000	1 100	1 300
340	520	133	5	—	473	1 670 000	3 300 000	1 000	1 200
	360	540	134	5	—	1 700 000	3 450 000	950	1 200

Note (1) The suffix KR represents bearings with tapered bores (taper 1 : 12).

Remark Production of double-row cylindrical roller bearings is generally in the high precision classes (Class 5 or better).

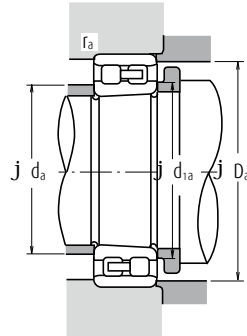
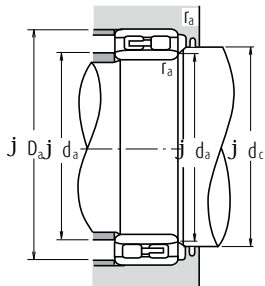

Bearing Numbers		Abutment and Fillet Dimensions (mm)							Mass (kg)
Cylindrical Bore	Tapered Bore (1)	d_a (2)		d_{1a}	d_c	D_a		r_a	approx.
		min.	max.	min.	min.	min.	max.	max.	
NNU 4930	NNU 4930 K	159	166	162	171	201	—	2	6.39
NN 3030	NN 3030 K	161	—	162	—	214	209	2	7.77
NNU 4932	NNU 4932 K	169	176	172	182	211	—	2	6.76
NN 3032	NN 3032 K	171	—	172	—	229	222	2	9.41
NNU 4934	NNU 4934 K	179	186	182	192	221	—	2	7.12
NN 3034	NN 3034 K	181	—	183	—	249	239	2	12.8
NNU 4936	NNU 4936 K	189	199	193	205	241	—	2	10.4
NN 3036	NN 3036 K	191	—	193	—	269	258	2	16.8
NNU 4938	NNU 4938 K	199	211	203	217	251	—	2	10.9
NN 3038	NN 3038 K	201	—	203	—	279	268	2	17.8
NNU 4940	NNU 4940 K	211	222	214	228	269	—	2	15.3
NN 3040	NN 3040 K	211	—	214	—	299	285	2	22.7
NNU 4944	NNU 4944 K	231	242	234	248	289	—	2	16.6
NN 3044	NN 3044 K	233	—	236	—	327	313	2.5	29.6
NNU 4948	NNU 4948 K	251	262	254	269	309	—	2	18
NN 3048	NN 3048 K	253	—	256	—	347	334	2.5	32.7
NNU 4952	NNU 4952 K	271	288	275	295	349	—	2	31.1
NN 3052	NN 3052 K	276	—	278	—	384	368	3	47.7
NNU 4956	NNU 4956 K	291	308	295	315	369	—	2	33
NN 3056	NN 3056 K	296	—	298	—	404	388	3	51.1
NNU 4960	NNU 4960 K	313	335	318	343	407	—	2.5	51.9
NN 3060	NN 3060 K	316	—	319	—	444	422	3	70.7
NNU 4964	NNU 4964 K	333	355	338	363	427	—	2.5	54.9
NN 3064	NN 3064 K	336	—	340	—	464	442	3	76.6
NN 3068	NN 3068 K	360	—	365	—	500	477	4	102
NN 3072	NN 3072 K	380	—	385	—	520	497	4	106

Note (2) d_a (max.) are values for adjusting rings for the NNU Type.

Full-Complement Cylindrical Roller Bearings

FULL-COMPLEMENT CYLINDRICAL ROLLER BEARINGS SINGLE-ROW(NCF), DOUBLE-ROW(NNCF)

DESIGN, TYPES, AND FEATURES

Cageless, full-complement cylindrical roller bearings have the maximum possible number of rollers and can sustain much heavier loads than cylindrical roller bearings of the same size with cages. On the other hand, high-speed capability is inferior to the bearings with cages.

The open-type single- and double-row bearings are mostly used in general industrial applications at low speed and under heavy load, and the shielded-type double-row bearings are often used in crane sheaves.

Table 1 Features of Various Types

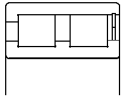
Figure	Type	Design and Features
	NCF	The outer and inner rings and rollers are non-separable since a retaining snap ring is installed at the side opposite the outer ring rib. They can sustain axial loads in only one direction.
	NNCF	NNCF is a double-row version of NCF. They can sustain heavy radial loads.

Bearing number example:

NCF 49 03 E

① Bearing type symbol

② Dimension symbol

④ Internal Design symbol

③ Bore Number

- ① Bearing Type Symbol: NCF: Single Row Cylindrical Roller Bearing
NNCF: Double Row Cylindrical Roller Bearing
- ② Dimension Symbol: 18: 18 Series, 29: 29 Series, 30: 30 Series
49: 49 Series, 50: 50 Series
- ③ Bore Number: Less than 03, Bearing bore 00 : 10 mm, 01 : 12 mm,
02 : 15 mm, 03 : 17 mm
Over 04, Bearing bore Bore number ×5 (mm)
- ④ Internal Design Symbol: V: full complement

TOLERANCES AND RUNNING ACCURACY Table 7.2 (Pages A128 to A131)

Single-Row
Double-Row

RECOMMENDED FITS

Single-Row
Double-Row

Inner Ring Rotation Table 8.3 (Page A164)

Table 8.5 (Page A165)

Outer Ring Rotation Table 2 below

Table 2 Fits and Internal Clearances for Full-Complement Cylindrical Roller Bearings



Operating Conditions		Fitting between Inner Ring and Shaft	Fitting between Outer Ring and Housing Bore	Recommended Internal Clearance
Outer Ring Rotation	Thin walled housings and heavy loads	g6 or h6	P7	C3
	Normal to heavy loads	g6 or h6	N7	C3
	Light or fluctuating loads	g6 or h6	M7	CN

Permissible Misalignment

The permissible misalignment of full-complement single-row cylindrical roller bearings is generally 0.0006 radian (2') under normal load. For double-row bearings, nearly no misalignment is allowed.

Full-Complement Cylindrical Roller Bearings for Sheaves

FULL-COMPLEMENT CYLINDRICAL ROLLER BEARINGS FOR SHEAVES

DESIGN, TYPES, AND FEATURES

Cylindrical Roller Bearings for sheaves are specially designed thin-walled, broad-width, full-complement type double-row cylindrical roller bearings, but they are widely used also for general industrial machines running at low speed and under heavy loads. There are several series as shown in Table 1.

Table 1 Series of Cylindrical Roller Bearings for Sheaves

Bearing Type		Fixed-End	Free-End
Open Type	Without Snap Ring	RS-48E4 RS-49E4	RSF-48E4 RSF-49E4
Shielded Type	Without Snap Ring With Snap Ring	RS-50 RS-50NR	—

Since all are non-separable type bearings, the inner and outer rings cannot be separated, but the RSF type can be used as a free-end bearing. In this case, the permissible axial displacement is listed in the bearing tables. Since cylindrical roller bearings for sheaves are a double-row, full-complement type, they can withstand heavy shock loads and moments and have sufficient axial load capacity for use in sheaves. Since the shielded type is a kind of bearing unit, the number of parts surrounding the bearing can be reduced, so it allows for a simple compact design. The surface of these bearings is treated for rust prevention.

Table 1 Features of Various Types

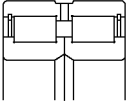
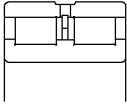
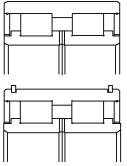
Figure	Type	Design and Features
	RS-48E4 RS-49E4	Double-row outer ring with center rib, two single-row inner rings with ribs. The outer and inner rings and rollers are non-separable since there are two retaining snap rings at the sides of the outer ring. They can sustain an axial load in either direction so they can be used as fixed-end bearings. An oil groove and holes are provided at the center of the outer ring.
	RSF-48E4 RSF-49E4	Double-row outer ring without ribs, double-row inner ring with three ribs. The outer and inner rings and rollers are non-separable since there is a retaining snap ring at the middle of the outer ring. They can be used as free-end bearings. The permissible axial movement is listed in the dimensional tables. An oil groove and holes are provided at the center of the outer ring.
	RS-50 RS-50NR	Both sides shielded, double-row outer ring with center rib, two inner rings with ribs. They can sustain an axial load in either direction. They are prelubricated, but it is possible to replenish the grease through an oil groove and holes in parts mating with the inner rings. If there are snap rings at the outside of the outer ring, this type becomes RS-50NR. They are surface-treated for rust prevention.

RECOMMENDED FITS AND INTERNAL CLEARANCES

When used with outer ring rotation for sheaves or wheels, the fit and radial internal clearance should conform to Table 3.

Table 3 Fits and Internal Clearances for Cylindrical Roller Bearings for Sheaves

Operating Conditions		Fitting between Inner Ring and Shaft	Fitting between Outer Ring and Housing Bore	Recommended Internal Clearance
Outer Ring Rotation	Thin walled housings and heavy loads	g6 or h6	P7	C3
	Normal to heavy loads	g6 or h6	N7	C3
	Light or fluctuating loads	g6 or h6	M7	CN

The fits listed in Tables 8.3 (Page A164) and 8.5 (Page A165) apply when they are used with inner ring rotation in general applications, and the internal clearance should conform to Table 4.

Table 4

Nominal Bore Dia. d (mm)		Clearances			
		CN		C3	
over	incl.	min.	max.	min.	max.
30	40	15	50	35	70
40	50	20	55	40	75
50	65	20	65	45	90
65	80	25	75	55	105
80	100	30	80	65	115
100	120	35	90	80	135
120	140	40	105	90	155
140	160	50	115	100	165
160	180	60	125	110	175
180	200	65	135	125	195
200	225	75	150	140	215
225	250	90	165	155	230
250	280	100	180	175	255
280	315	110	195	195	280
315	355	125	215	215	305
355	400	140	235	245	340
400	450	155	275	270	390
450	500	180	300	300	420

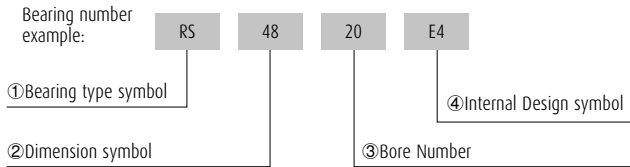

- ① Bearing type Symbol: RS: Fixed End Bearing
RSF: Free End Bearing
- ② Dimension Symbol: 48: 48 Series, 49: 49 Series, 40: 50 Series
- ③ Bore number: Less than 03, Bearing bore 00 : 10 mm, 01 : 12 mm, 02 : 15 mm, 03 : 17 mm
Over 04, Bearing bore Bore number ×5 (mm)
- ④ Internal Design Symbol: E4: Lubrication grooves and holes in outring

Full-Complement Cylindrical Roller Bearings

NCF Type, Single-Row

Bore Diameter 100 – 260 mm

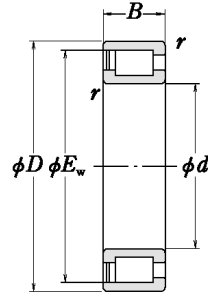

Boundary Dimensions (mm)					Basic Load Ratings (kN)		Bearing Numbers
d	D	B	r min.	E_w	C_r	C_{0r}	
100	140	24	1.1	130.5	132	209	NCF2920V
	150	37	1.5	139.7	209	310	NCF3020V
110	150	24	1.1	141	138	229	NCF2922V
	170	45	2	156.3	278	405	NCF3022V
120	165	27	1.1	154	177	305	NCF2924V
	180	46	2	167.58	293	440	NCF3024V
130	180	30	1.5	166.5	210	370	NCF2926V
	200	52	2	183.81	415	615	NCF3026V
	190	30	1.5	179.4	227	395	NCF2928V
140	210	53	2	197.82	435	680	NCF3028V
	150	210	36	2	195	289	505
160	225	56	2.1	206.82	460	710	NCF3030V
	220	36	2	207	310	535	NCF2932V
170	240	60	2.1	224.8	520	810	NCF3032V
	215	22	1.5	203.5	149	272	NCF1834V
	230	36	2	218	320	570	NCF2934V
180	260	67	2.1	242.87	675	1 070	NCF3034V
	225	22	1.5	215	154	290	NCF1836V
	250	42	2	231.5	390	695	NCF2936V
190	280	74	2.1	260.3	785	1 260	NCF3036V
	240	24	1.5	228.7	178	335	NCF1838V
	260	42	2	243.6	435	785	NCF2938V
200	290	75	2.1	269.9	805	1 320	NCF3038V
	250	24	1.5	237	182	350	NCF1840V
	280	48	2.1	261	530	955	NCF2940V
220	310	82	2.1	287.8	910	1 510	NCF3040V
	270	24	2	257.7	191	385	NCF1844V
	300	48	2.1	282	555	1 050	NCF2944V
240	340	90	3	312.3	1 100	1 820	NCF3044V
	300	28	2	283	236	470	NCF1848V
	320	48	2.1	303	580	1 140	NCF2948V
260	360	92	3	335.25	1 160	1 990	NCF3048V
	320	28	2	307	247	510	NCF1852V
	360	60	2.1	333.2	750	1 460	NCF2952V
400	104	4	376.1	1 570	2 600	NCF3052V	

Remark Full-complement cylindrical roller bearings are designed for specific applications, when using them, please contact NSK.

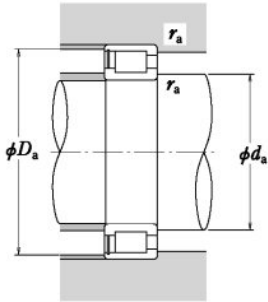

Abutment and Fillet Dimensions (mm)			Mass (kg)
d_a min.	D_a max.	r_a max.	approx.
109	131	1	1.0
111	140	1.5	2.1
119	142	1	1.1
122	157	2	3.3
130	155	1	1.7
132	168	2	3.6
141	168	1.5	2.2
142	187	2	5.6
151	180	1.5	2.3
152	198	2	5.9
163	196	2	3.7
165	209	2	7.1
173	208	2	3.8
175	225	2	8.6
182	204	1.5	1.8
183	219	2	4.1
185	244	2	11.9
192	216	1.5	1.8
193	236	2	6.0
195	263	2	15.8
202	229	1.5	2.4
203	245	2	6.5
206	273	2	16.7
213	238	1.5	2.5
216	263	2	8.9
216	293	2	21.4
234	258	2	2.7
236	283	2	9.6
238	320	2.5	28.2
254	285	2	4.2
257	304	2	10.4
259	340	2.5	31.2
275	308	2	4.5
277	342	2	18.1
282	377	3	45.3



Full-Complement Cylindrical Roller Bearings

NCF Type, Single-Row

Bore Diameter 300 – 800 mm

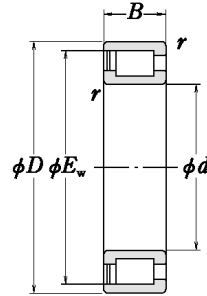

Boundary Dimensions (mm)					Basic Load Ratings (kN)		Bearing Numbers
d	D	B	r min.	E _w	C _r	C _{0r}	
300	380	38	2.5	359	445	870	NCF1860V
	420	72	3	389.6	1 120	2 220	NCF2960V
	460	118	4	341.7	1 980	3 500	NCF3060V
320	400	38	2.1	380	460	925	NCF1864V
	440	72	3	410	1 150	2 340	NCF2964V
	480	121	4	449.6	2 170	3 900	NCF3064V
340	420	38	2.1	401	475	985	NCF1868V
	460	72	3	430.3	1 190	2 470	NCF2968V
	520	133	5	485.8	2 480	4 350	NCF3068V
360	440	38	2.5	422	490	1 040	NCF1872V
	480	72	3	450.7	1 220	2 610	NCF2972V
	540	134	5	503.6	2 550	4 600	NCF3072V
380	480	46	2.5	452.8	575	1 230	NCF1876V
	520	82	4	486.7	1 600	3 350	NCF2976V
	560	135	5	521.4	2 610	4 800	NCF3076V
400	500	46	2.5	475.7	590	1 300	NCF1880V
	540	82	4	511	1 650	3 550	NCF2980V
	600	148	5	558.7	3 050	5 750	NCF3080AV
420	520	46	2.1	491	600	1 340	NCF1884V
	560	82	4	523.2	1 680	3 650	NCF2984V
	620	150	5	577.7	3 000	5 650	NCF3084V
440	540	46	2.1	514	615	1 410	NCF1888V
	600	95	4	562	2 070	4 300	NCF2988V
	660	156	5	619.7	3 500	6 300	NCF3088V
460	580	56	3	552.7	920	1 950	NCF1892V
	620	95	4	576.5	2 100	4 450	NCF2992V
	680	156	5	634.2	3 600	6 500	NCF3092V
480	600	56	3	573	940	2 040	NCF1896V
	650	100	5	615	2 380	5 100	NCF2996V
	700	156	5	672.7	4 000	7 500	NCF3096V
500	620	56	3	593.5	960	2 120	NCF18/500V
	670	100	5	630.2	2 420	5 250	NCF29/500V
	720	156	5	687.7	4 100	7 700	NCF30/500V
530	650	56	3	624	990	2 240	NCF18/530V
	700	100	5	666.2	2 520	5 400	NCF29/530V
	750	156	5	723.7	4 200	7 900	NCF30/530V
560	680	56	3	654.7	1 020	2 360	NCF18/560V
	730	100	5	696.2	2 600	5 600	NCF29/560V
	780	156	5	753.7	4 300	8 100	NCF30/560V
600	730	60	3	695.5	1 140	2 680	NCF18/600V
	780	100	5	737.2	2 700	5 800	NCF29/600V
	830	156	5	794.7	4 400	8 300	NCF30/600V
630	780	69	4	742	1 470	3 400	NCF18/630V
	830	100	5	783.2	2 800	6 000	NCF29/630V
	880	156	5	840.7	4 500	8 500	NCF30/630V
670	820	69	4	780	1 520	3 550	NCF18/670V
	870	100	5	821.2	2 900	6 200	NCF29/670V
	920	156	5	878.7	4 600	8 700	NCF30/670V
710	870	74	4	832.5	1 650	3 900	NCF18/710V
	920	100	5	874.2	3 000	6 400	NCF29/710V
	970	156	5	931.7	4 700	9 000	NCF30/710V
750	920	78	4	882.3	1 930	4 600	NCF18/750V
	970	100	5	923.2	3 200	6 600	NCF29/750V
	1020	156	5	980.7	4 900	9 200	NCF30/750V
800	980	82	5	936	2 110	5 100	NCF18/800V
	1030	100	5	977.2	3 400	7 200	NCF29/800V
	1080	156	5	1034.7	5 100	10 000	NCF30/800V

Remark Full-complement cylindrical roller bearings are designed for specific applications, when using them, please contact NSK.

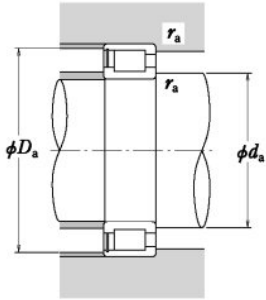

Abutment and Fillet Dimensions (mm)			Mass (kg)
d_a min.	D_a max.	r_a max.	approx.
319	360	2	9.7
320	398	2.5	30.7
323	435	3	67.6
338	381	2	10.3
340	418	2.5	33
343	454	3	73
359	402	2	10.7
361	438	2.5	34.1
368	490	4	97
380	423	2	11.5
381	457	2.5	36
388	509	4	102
400	458	2	18.6
404	493	3	52
408	529	4	108
421	478	2	19.5
425	513	3	53.4
429	568	4	139
440	498	2	20.5
445	533	3	55.7
449	588	4	147
461	518	2	21.3
466	572	3	78.2
483	555	2.5	32.5
486	591	3	81.2
503	575	2.5	33.8
510	617	4	95.1
524	594	2.5	35
531	637	4	98.4
554	625	2.5	36.9
585	655	2.5	39.3
598	778	5	332.5
626	702	2.5	48.9
633	764	4	164.9
659	748	3	68.8
700	787	3	72.7
741	836	3	87.6
786	883	4	103.3
832	950	4	123.1



Full-Complement Cylindrical Roller Bearings

NNCF Type, Double-Row

Bore Diameter 100 – 260 mm

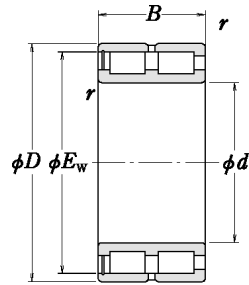

Boundary Dimensions (mm)					Basic Load Ratings (kN)		Bearing Numbers
d	D	B	r min.	E _w	C _r	C _{0r}	
100	140	40	1.1	129.8	194	400	NNCF4920V
	150	67	1.5	139.7	360	615	NNCF5020V
110	150	40	1.1	138.4	202	430	NNCF4922V
	170	80	2	156.3	490	840	NNCF5022V
120	165	45	1.1	153.8	226	480	NNCF4924V
	180	80	2	167.58	500	885	NNCF5024V
130	180	50	1.5	165.7	262	555	NNCF4926V
	200	95	2	183.81	710	1 230	NNCF5026V
140	190	50	1.5	176.2	272	595	NNCF4928V
	210	95	2	197.82	750	1 360	NNCF5028V
150	210	60	2	191.6	390	865	NNCF4930V
	225	100	2.1	206.82	785	1 420	NNCF5030V
160	220	60	2	204.1	410	930	NNCF4932V
	240	109	2.1	224.8	895	1 620	NNCF5032V
170	230	60	2	212.4	415	975	NNCF4934V
	260	122	2.1	242.87	1 160	2 140	NNCF5034V
180	250	69	2	230.5	550	1 230	NNCF4936V
	280	136	2.1	260.3	1 340	2 510	NNCF5036V
190	260	69	2	240.7	565	1 290	NNCF4938V
	290	136	2.1	269.9	1 380	2 630	NNCF5038V
200	250	50	1.5	235.9	320	825	NNCF4840V
	280	80	2.1	259.5	665	1 500	NNCF4940V
220	310	150	2.1	287.75	1 560	3 000	NNCF5040V
	270	50	1.5	256.9	340	905	NNCF4844V
240	300	80	2.1	277	695	1 620	NNCF4944V
	340	160	3	312.3	1 890	3 650	NNCF5044V
240	300	60	2	282.6	495	1 340	NNCF4848V
	320	80	2.1	300	725	1 770	NNCF4948V
260	360	160	3	335.25	1 990	4 000	NNCF5048V
	320	60	2	303.6	515	1 450	NNCF4852V
400	360	100	2.1	331.5	1 050	2 530	NNCF4952V
	400	190	4	376.1	2 690	5 200	NNCF5052V

Remark Full-complement cylindrical roller bearings are designed for specific applications, when using them, please contact NSK.

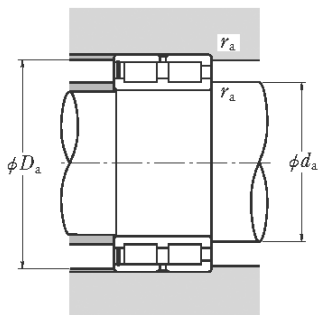

Abutment and Fillet Dimensions (mm)			Mass (kg)
d_a min.	D_a max.	r_a max.	approx.
109	130	1	2.0
111	140	1.5	3.8
119	140	1	2.1
122	157	2	6.1
130	155	1	2.9
132	168	2	6.5
141	168	1.5	3.9
142	187	2	10.3
151	178	1.5	4.2
152	198	2	10.8
163	196	2	6.6
165	209	2	13
173	206	2	7.0
175	225	2	15.8
183	216	2	7.3
185	244	2	22.1
193	236	2	10.7
195	263	2	29.4
203	245	2	11.1
206	273	2	30.8
213	237	1.5	5.9
216	263	2	15.7
216	293	2	39.7
233	257	1.5	6.4
236	283	2	17
238	320	2.5	50.7
254	285	2	10.3
257	302	2	18.4
259	340	2.5	54.3
275	304	2	11
277	342	2	32
282	377	2	82.7



Full-Complement Cylindrical Roller Bearings

NNCF Type, Double-Row

Bore Diameter 280 - 500 mm

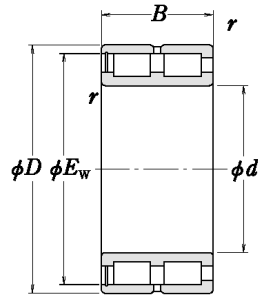

Boundary Dimensions (mm)					Basic Load Ratings (kN)		Bearing Numbers
d	D	B	r min.	E _w	C _r	C _{0r}	
280	350	69	2	332.5	685	1 860	NNCF4856V
	380	100	2.1	352.5	1 090	2 720	NNCF4956V
300	420	190	4	390.5	2 770	5 450	NNCF5056V
	380	80	2.1	357.2	805	2 160	NNCF4860V
320	420	118	3	386.5	1 580	3 800	NNCF4960V
	460	218	4	431.7	3 400	7 000	NNCF5060V
340	400	80	2.1	380.2	835	2 310	NNCF4864V
	440	118	3	404.5	1 620	4 000	NNCF4964V
360	480	218	4	446.9	3 500	7 350	NNCF5064V
	420	80	2.1	397.4	855	2 430	NNCF4868V
380	460	118	3	431	1 690	4 300	NNCF4968V
	520	243	5	485.8	4 250	8 750	NNCF5068V
400	440	80	2.1	420.4	885	2 580	NNCF4872V
	480	118	3	449	1 730	4 500	NNCF4972V
420	540	243	5	503.6	4 350	9 150	NNCF5072V
	480	100	2.1	450.6	1 260	3 600	NNCF4876V
440	520	140	4	482.5	2 180	5 650	NNCF4976V
	560	243	5	521.4	4 500	9 600	NNCF5076V
460	500	100	2.1	471.7	1 290	3 750	NNCF4880V
	540	140	4	503	2 240	5 900	NNCF4980V
480	600	272	5	558.7	5 050	10 900	NNCF5080V
	520	100	2.1	492	1 320	3 950	NNCF4884V
500	560	140	4	523	2 290	6 200	NNCF4984V
	620	272	5	577.7	5 150	11 300	NNCF5084V
440	540	100	2.1	513	1 350	4 150	NNCF4888V
	600	160	4	560.5	3 000	7 850	NNCF4988V
460	580	118	3	549.2	1 730	5 150	NNCF4892V
	620	160	4	573	3 050	8 050	NNCF4992V
480	600	118	3	565.8	1 760	5 300	NNCF4896V
	650	170	5	603	3 350	8 900	NNCF4996V
500	620	118	3	590.7	1 810	5 600	NNCF48/500V
	670	170	5	629	3 400	9 350	NNCF49/500V

Remark Full-complement cylindrical roller bearings are designed for specific applications, when using them, please contact NSK.

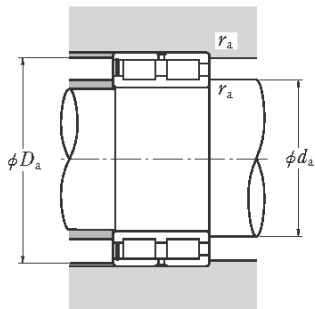

Abutment and Fillet Dimensions (mm)			Mass (kg)
d_a min.	D_a max.	r_a max.	approx.
295	334	2	16
297	361	2	34
302	395	3	87.7
318	361	2	23
320	398	2.5	52
323	435	3	125
338	381	2	24.3
340	418	2.5	55
343	454	3	131
359	400	2	25.6
361	438	2.5	58
368	490	4	177
379	421	2	27
381	457	2.5	61
388	509	4	186
399	459	2	45.5
404	493	3	90.5
408	529	4	194
420	479	2	47.5
425	513	3	94.5
429	568	4	256
440	498	2	49.5
445	533	3	98.5
449	588	4	267
461	518	2	51.5
466	572	3	136
483	555	2.5	77.5
486	591	3	142
503	575	2.5	80.5
510	617	4	167
524	594	2.5	83.5
531	637	4	173



Full-Complement Cylindrical Roller Bearings for Sheaves

RS-48 · RS-49 Types

RSF-48 · RSF-49 Types

Bore Diameter 50 – 220 mm

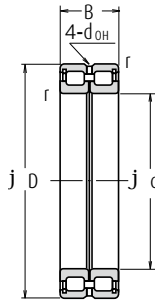

Fixed-End Bearing
RS

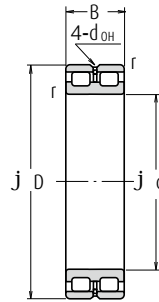

Free-End Bearing
RSF

Boundary Dimensions (mm)				Basic Load Ratings (N)		Limiting Speeds (min ⁻¹)	
d	D	B	r min.	C _i	C _{0r}	Grease	Oil
50	72	22	0.6	48 000	75 500	2 000	4 000
60	85	25	1	68 500	118 000	1 600	3 200
65	90	25	1	70 500	125 000	1 600	3 200
70	100	30	1	102 000	168 000	1 400	2 800
80	110	30	1	109 000	191 000	1 300	2 600
90	125	35	1.1	147 000	268 000	1 100	2 200
100	125	25	1	87 500	189 000	1 100	2 200
	140	40	1.1	194 000	400 000	1 000	2 000
105	130	25	1	89 000	196 000	1 000	2 000
	145	40	1.1	199 000	420 000	950	1 900
110	140	30	1	114 000	260 000	950	1 900
	150	40	1.1	202 000	430 000	900	1 800
120	150	30	1	119 000	283 000	900	1 800
	165	45	1.1	226 000	480 000	800	1 600
130	165	35	1.1	162 000	390 000	800	1 600
	180	50	1.5	262 000	555 000	750	1 500
140	175	35	1.1	167 000	415 000	710	1 400
	190	50	1.5	272 000	595 000	670	1 400
150	190	40	1.1	235 000	575 000	670	1 300
	210	60	2	390 000	865 000	630	1 300
160	200	40	1.1	243 000	615 000	600	1 200
	220	60	2	410 000	930 000	600	1 200
170	215	45	1.1	265 000	650 000	600	1 200
	230	60	2	415 000	975 000	600	1 200
180	225	45	1.1	272 000	685 000	560	1 100
	250	69	2	495 000	1 130 000	530	1 100
190	240	50	1.5	315 000	785 000	530	1 100
	260	69	2	510 000	1 180 000	500	1 000
200	250	50	1.5	320 000	825 000	500	1 000
	280	80	2.1	665 000	1 500 000	480	950
220	270	50	1.5	340 000	905 000	450	900
	300	80	2.1	695 000	1 620 000	430	850

Remark Cylindrical roller bearings for sheaves are designed for specific applications, when using them, please contact NSK.

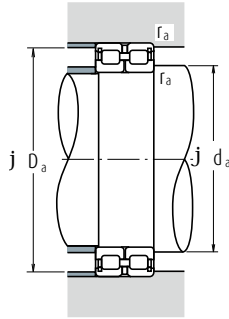

Bearing Numbers ⁽¹⁾		Dimensions (mm)		Abutment and Fillet Dimensions (mm)			Mass (kg)
Fixed-End Bearing	Free-End Bearing	$d_{OH}^{(2)}$	Axial Disp. ⁽³⁾	d_a min.	D_a max.	r_a max.	approx.
RS-4910E4	RSF-4910E4	2.5	1.5	54	68	0.6	0.30
RS-4912E4	RSF-4912E4	2.5	1.5	65	80	1	0.46
RS-4913E4	RSF-4913E4	2.5	2	70	85	1	0.50
RS-4914E4	RSF-4914E4	3	2	75	95	1	0.79
RS-4916E4	RSF-4916E4	3	2	85	105	1	0.89
RS-4918E4	RSF-4918E4	3	2	96.5	118.5	1	1.35
RS-4820E4	RSF-4820E4	2.5	1.5	105	120	1	0.74
RS-4920E4	RSF-4920E4	3	2	106.5	133.5	1	1.97
RS-4821E4	RSF-4821E4	2.5	1.5	110	125	1	0.77
RS-4921E4	RSF-4921E4	3	2	111.5	138.5	1	2.05
RS-4822E4	RSF-4822E4	3	2	115	135	1	1.09
RS-4922E4	RSF-4922E4	3	2	116.5	143.5	1	2.15
RS-4824E4	RSF-4824E4	3	2	125	145	1	1.28
RS-4924E4	RSF-4924E4	4	3	126.5	158.5	1	2.95
RS-4826E4	RSF-4826E4	3	2	136.5	158.5	1	1.9
RS-4926E4	RSF-4926E4	5	3.5	138	172	1.5	3.95
RS-4828E4	RSF-4828E4	3	2	146.5	168.5	1	2.03
RS-4928E4	RSF-4928E4	5	3.5	148	182	1.5	4.25
RS-4830E4	RSF-4830E4	3	2	156.5	183.5	1	2.85
RS-4930E4	RSF-4930E4	5	3.5	159	201	2	6.65
RS-4832E4	RSF-4832E4	3	2	166.5	193.5	1	3.05
RS-4932E4	RSF-4932E4	5	3.5	169	211	2	7.0
RS-4834E4	RSF-4834E4	4	3	176.5	208.5	1	4.1
RS-4934E4	RSF-4934E4	4	3.5	179	221	2	7.35
RS-4836E4	RSF-4836E4	4	3	186.5	218.5	1	4.3
RS-4936E4	RSF-4936E4	6	4.5	189	241	2	10.7
RS-4838E4	RSF-4838E4	5	3.5	198	232	1.5	5.65
RS-4938E4	RSF-4938E4	6	4.5	199	251	2	11.1
RS-4840E4	RSF-4840E4	5	3.5	208	242	1.5	5.95
RS-4940E4	RSF-4940E4	7	5	211	269	2	15.7
RS-4844E4	RSF-4844E4	5	3.5	228	262	1.5	6.45
RS-4944E4	RSF-4944E4	7	5	231	289	2	17

- Notes**
- (1) The suffix E4 indicates that the outer ring is provided with oil holes and oil groove.
 - (2) d_{OH} represents the oil hole diameter in the outer ring.
 - (3) Permissible axial displacement for free-end bearings.

Full-Complement Cylindrical Roller Bearings for Sheaves

RS-48 · RS-49 Types

RSF-48 · RSF-49 Types

Bore Diameter 240 – 560 mm

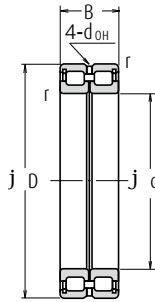

Fixed-End Bearing
RS

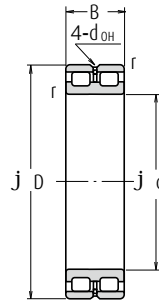

Free-End Bearing
RSF

Boundary Dimensions (mm)				Basic Load Ratings (N)		Limiting Speeds (min ⁻¹)	
d	D	B	r min.	C _i	C _{0r}	Grease	Oil
240	300	60	2	495 000	1 340 000	430	850
	320	80	2.1	725 000	1 770 000	400	800
260	320	60	2	515 000	1 450 000	380	750
	360	100	2.1	1 050 000	2 530 000	360	710
280	350	69	2	610 000	1 690 000	340	710
	380	100	2.1	1 090 000	2 720 000	340	670
300	380	80	2.1	805 000	2 160 000	320	630
	420	118	3	1 460 000	3 400 000	300	600
320	400	80	2.1	835 000	2 310 000	300	600
	440	118	3	1 500 000	3 600 000	280	560
340	420	80	2.1	855 000	2 430 000	280	560
	460	118	3	1 560 000	3 900 000	260	530
360	440	80	2.1	885 000	2 580 000	260	530
	480	118	3	1 600 000	4 050 000	260	500
380	480	100	2.1	1 260 000	3 600 000	240	500
	520	140	4	2 040 000	5 200 000	240	450
400	500	100	2.1	1 290 000	3 750 000	240	480
	540	140	4	2 100 000	5 450 000	220	450
420	520	100	2.1	1 320 000	3 950 000	220	450
	560	140	4	2 150 000	5 700 000	200	430
440	540	100	2.1	1 350 000	4 150 000	200	430
	600	160	4	2 840 000	7 350 000	190	380
460	580	118	3	1 730 000	5 150 000	190	380
	620	160	4	2 870 000	7 500 000	190	380
480	600	118	3	1 760 000	5 300 000	190	380
	650	170	5	3 200 000	8 500 000	180	360
500	620	118	3	1 810 000	5 600 000	180	360
	670	170	5	3 300 000	8 900 000	170	340
530	710	180	5	3 400 000	9 200 000	160	320
560	750	190	5	3 800 000	10 100 000	150	300

Remark Cylindrical roller bearings for sheaves are designed for specific applications, when using them, please contact NSK.

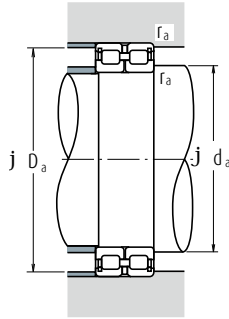

Bearing Numbers (1)		Dimensions (mm)		Abutment and Fillet Dimensions (mm)			Mass (kg)
Fixed-End Bearing	Free-End Bearing	d_{OH} (2)	Axial Disp.(3)	d_a min.	D_a max.	r_a max.	approx.
RS-4848E4	RSF-4848E4	5	3.5	249	291	2	10.3
RS-4948E4	RSF-4948E4	7	5	251	309	2	18.4
RS-4852E4	RSF-4852E4	5	3.5	269	311	2	11
RS-4952E4	RSF-4952E4	8	6	271	349	2	32
RS-4856E4	RSF-4856E4	6	4.5	289	341	2	16
RS-4956E4	RSF-4956E4	8	6	291	369	2	34
RS-4860E4	RSF-4860E4	6	5	311	369	2	23
RS-4960E4	RSF-4960E4	9	7	313	407	2.5	52
RS-4864E4	RSF-4864E4	6	5	331	389	2	24.3
RS-4964E4	RSF-4964E4	9	7	333	427	2.5	55
RS-4868E4	RSF-4868E4	6	5	351	409	2	25.6
RS-4968E4	RSF-4968E4	9	7	353	447	2.5	58
RS-4872E4	RSF-4872E4	6	5	371	429	2	27
RS-4972E4	RSF-4972E4	9	7	373	467	2.5	61
RS-4876E4	RSF-4876E4	8	6	391	469	2	45.5
RS-4976E4	RSF-4976E4	11	8	396	504	3	90.5
RS-4880E4	RSF-4880E4	8	6	411	489	2	47.5
RS-4980E4	RSF-4980E4	11	8	416	524	3	94.5
RS-4884E4	RSF-4884E4	8	6	431	509	2	49.5
RS-4984E4	RSF-4984E4	11	8	436	544	3	98.5
RS-4888E4	RSF-4888E4	8	6	451	529	2	51.5
RS-4988E4	RSF-4988E4	11	8	456	584	3	136
RS-4892E4	RSF-4892E4	9	7	473	567	2.5	77.5
RS-4992E4	RSF-4992E4	11	8	476	604	3	142
RS-4896E4	RSF-4896E4	9	7	493	587	2.5	80.5
RS-4996E4	RSF-4996E4	12	9	500	630	4	167
RS-48/500E4	RSF-48/500E4	9	7	513	607	2.5	83.5
RS-49/500E4	RSF-49/500E4	12	9	520	650	4	173
RS-49/530E4	RSF-49/530E4	12	11	550	690	4	206
RS-49/560E4	RSF-49/560E4	12	11	580	730	4	231

- Notes**
- (1) The suffix E4 indicates that the outer ring is provided with oil holes and oil groove.
 - (2) d_{OH} represents the oil hole diameter in the outer ring.
 - (3) Permissible axial displacement for free-end bearings.

Full-Complement Cylindrical Roller Bearings for Sheaves

RS-50 Type (Prelubricated) Bore Diameter 40 – 400 mm

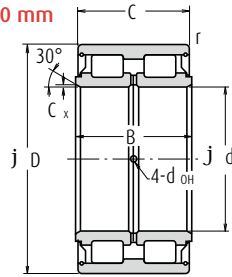

Without Locating Rings

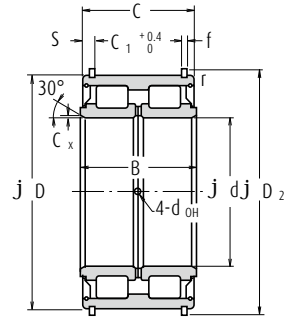

With Locating Rings

Boundary Dimensions (mm)						Basic Load Ratings (N)		Limiting Speeds (min ⁻¹)
d	D	B	C	C _x ⁽¹⁾ min.	r min.	C _r	C _{0r}	Grease
40	68	38	37	0.4	0.6	79 500	116 000	2 400
45	75	40	39	0.4	0.6	95 500	144 000	2 200
50	80	40	39	0.4	0.6	100 000	158 000	2 000
55	90	46	45	0.6	0.6	118 000	193 000	1 800
60	95	46	45	0.6	0.6	123 000	208 000	1 700
65	100	46	45	0.6	0.6	128 000	224 000	1 600
70	110	54	53	0.6	0.6	171 000	285 000	1 400
75	115	54	53	0.6	0.6	179 000	305 000	1 400
80	125	60	59	0.6	0.6	251 000	430 000	1 200
85	130	60	59	0.6	0.6	256 000	445 000	1 200
90	140	67	66	1	0.6	305 000	540 000	1 100
95	145	67	66	1	0.6	310 000	565 000	1 100
100	150	67	66	1	0.6	320 000	585 000	1 000
110	170	80	79	1.1	1	385 000	695 000	900
120	180	80	79	1.1	1	400 000	750 000	850
130	200	95	94	1.1	1	535 000	1 000 000	750
140	210	95	94	1.1	1	550 000	1 040 000	710
150	225	100	99	1.3	1	620 000	1 210 000	670
160	240	109	108	1.3	1.1	695 000	1 370 000	630
170	260	122	121	1.3	1.1	860 000	1 680 000	600
180	280	136	135	1.3	1.1	980 000	1 910 000	530
190	290	136	135	1.3	1.1	1 120 000	2 230 000	500
200	310	150	149	1.3	1.1	1 310 000	2 650 000	480
220	340	160	159	1.5	1.1	1 510 000	3 100 000	430
240	360	160	159	1.5	1.1	1 570 000	3 350 000	400
260	400	190	189	1.5	1.5	2 130 000	4 500 000	360
280	420	190	189	1.5	1.5	2 170 000	4 700 000	340
300	460	218	216	1.5	1.5	2 670 000	5 850 000	300
320	480	218	216	1.5	1.5	2 720 000	6 100 000	300
340	520	243	241	2	2	3 350 000	7 550 000	260
360	540	243	241	2	2	3 450 000	7 850 000	260
380	560	243	241	2	2	3 550 000	8 400 000	240
400	600	272	270	2	2	4 250 000	9 950 000	220

Note (1) Chamfer dimension of inner ring in radial direction.

- Remarks**
1. Good quality grease is prepacked in bearings.
 2. Grease can be supplied through oil holes in the inner rings.

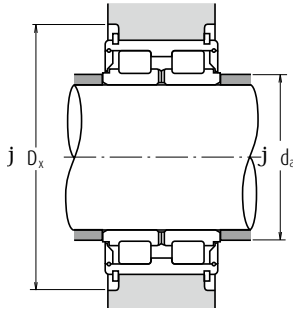

Bearing Numbers		Locating Ring Dimensions (mm)				Oil Holes (mm)	Abutment and Fillet Dimensions (mm)		Mass (kg)
Without Locating Rings	With Locating Rings	C_1	S	D_2	f	d_{OH}	d_a min.	D_x min.	approx.
RS-5008	RS-5008NR	28	4.5	71.8	2	2.5	43.5	77.5	0.56
RS-5009	RS-5009NR	30	4.5	78.8	2	2.5	48.5	84.5	0.70
RS-5010	RS-5010NR	30	4.5	83.8	2	2.5	53.5	89.5	0.76
RS-5011	RS-5011NR	34	5.5	94.8	2.5	3	60	101	1.17
RS-5012	RS-5012NR	34	5.5	99.8	2.5	3	65	106	1.25
RS-5013	RS-5013NR	34	5.5	104.8	2.5	3	70	111	1.32
RS-5014	RS-5014NR	42	5.5	114.5	2.5	3	75	121	1.87
RS-5015	RS-5015NR	42	5.5	119.5	2.5	3	80	126	2.0
RS-5016	RS-5016NR	48	5.5	129.5	2.5	3	85	136	2.65
RS-5017	RS-5017NR	48	5.5	134.5	2.5	3	90	141	2.75
RS-5018	RS-5018NR	54	6	145.4	2.5	4	96	153.5	3.75
RS-5019	RS-5019NR	54	6	150.4	2.5	4	101	158.5	3.95
RS-5020	RS-5020NR	54	6	155.4	2.5	4	106	163.5	4.05
RS-5022	RS-5022NR	65	7	175.4	2.5	5	116.5	183.5	6.1
RS-5024	RS-5024NR	65	7	188	3	5	126.5	197	7.0
RS-5026	RS-5026NR	77	8.5	207	3	5	136.5	217	10.6
RS-5028	RS-5028NR	77	8.5	217	3	5	146.5	227	11.3
RS-5030	RS-5030NR	81	9	232	3	6	157	242	13.7
RS-5032	RS-5032NR	89	9.5	247	3	6	167	257	16.8
RS-5034	RS-5034NR	99	11	270	4	6	177	285	22.2
RS-5036	RS-5036NR	110	12.5	294	5	6	187	318	30
RS-5038	RS-5038NR	110	12.5	304	5	6	197	328	32
RS-5040	RS-5040NR	120	14.5	324	5	6	207	352	41
RS-5044	RS-5044NR	130	14.5	356	6	7	228.5	382	53
RS-5048	RS-5048NR	130	14.5	376	6	7	248.5	402	57
RS-5052	RS-5052NR	154	17.5	416	7	8	270	444	86
RS-5056	RS-5056NR	154	17.5	436	7	8	290	472	92
RS-5060	RS-5060NR	178	19	476	7	8	310	512	130
RS-5064	—	—	—	—	—	8	330	—	135
RS-5068	—	—	—	—	—	10	352	—	185
RS-5072	—	—	—	—	—	10	372	—	192
RS-5076	—	—	—	—	—	10	392	—	196
RS-5080	—	—	—	—	—	10	412	—	280

- Remarks**
3. Cylindrical roller bearings for sheaves are designed for specific applications, when using them, please contact NSK.
 4. For shield with outside diameter larger than 180 mm, the above figure is different actual shape. For detail drawing, please contact NSK.

Tapered Roller Bearings



6. TAPERED ROLLER BEARINGS

Introduction..... B 200

TECHNICAL DATA

Free Space of Tapered Roller Bearings..... B 206

SINGLE-ROW TAPERED ROLLER BEARINGS

Bore Dia.	Page
15 - 100 mm.....	B 208
105 - 240 mm.....	B 220
260 - 440 mm.....	B 226

INCH DESIGN TAPERED ROLLER BEARINGS

Bore Dia.	Page
12.000 - 47.625 mm.....	B 228
48.412 - 69.850 mm.....	B 242
70.000 - 206.375 mm.....	B 250

The index for inch design tapered roller bearings is in Appendix 14 (Page C020).

DOUBLE-ROW TAPERED ROLLER BEARINGS

Bore Dia.	Page
40 - 260 mm.....	B 264



Tapered Roller Bearings

DESIGN, TYPES AND FEATURES

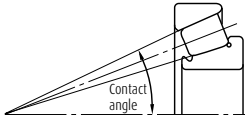

Tapered roller bearings are designed so the apices of the cones formed by the raceways of the cone and cup and the conical rollers all coincide at one point on the axis of the bearing. When a radial load is imposed, an axial force component occurs; therefore, it is necessary to use two bearings in opposition or some other multiple arrangement.

For metric-design medium-angle and steep-angle tapered roller bearings, the respective contact angle symbol C or D is added after the bore number. For normal-angle tapered roller bearings, no contact angle symbol is used.

Medium-angle tapered roller bearings are primarily used for the pinion shafts of differential gears of automobiles.

Among those with high load capacity (HR series), some bearings have the basic number suffixed by J to conform to the specifications of ISO for the cup back face raceway diameter, cup width, and contact angle. Therefore, the cone assembly and cup of bearings with the same basic number suffixed by J are internationally interchangeable.

Among metric-design tapered roller bearings specified by ISO 355, there are those having new dimensions that are different from the dimension series 3XX used in the past. Part of them are listed in the bearing tables. They conform to the specifications of ISO for the smaller end diameter of the cup and contact angle. The cone and cup assemblies are internationally interchangeable. The bearing number formulation, which is different from that for past metric design, is as follows:

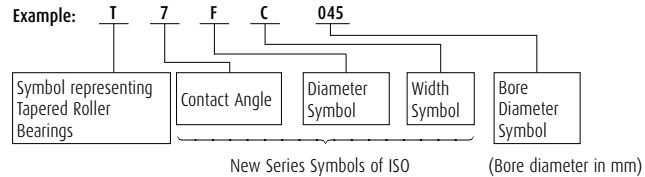

Besides metric design tapered roller bearings, there are also inch design bearings. For the cone assemblies and cups of inch design bearings, except four-row tapered roller bearings, the bearing numbers are approximately formulated as follows:

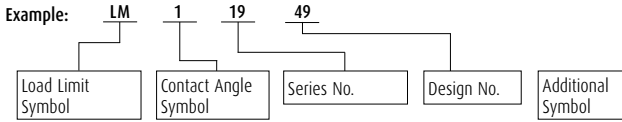

For tapered roller bearings, besides single-row bearings, there are also various combinations of bearings. The cages of tapered roller bearings are usually pressed steel.

Table 1 Design and Features of Combinations of Tapered Roller Bearings

Figure	Arrangement	Examples of Bearing No.	Features
	Back-to-back	HR30210JDB+KLR10	Two standard bearings are combined. The bearing clearance are adjusted by cone spacers or cup spacers. The cones and cups and spacers are marked with serial numbers and mating marks. Components with the same serial number can be assembled referring to the matching symbols.
	Face-to-face	HR30210JDF+KR	
	KBE Type	100KBE31+L	The KBE type is a back-to-back arrangement of bearings with the cup and spacer integrated, and the KH type is a face-to-face arrangement in which the cones are integrated. Since the bearing clearance is adjusted using spacers, it is necessary for components to have the same serial number for assembly with reference to matching symbols.
	KH Type	110KH31+K	

Tapered Roller Bearings

TOLERANCES AND RUNNING ACCURACY

Metric Design Tapered Roller Bearings

Inch Design Tapered Roller Bearings

Among inch design tapered roller bearings, there are those to which the following precision classes apply. For more details, please consult with NSK.

Tables

Pages

7.3 A 132 to A 135

7.4 A 136 and A 137

1. J line bearings (in the bearing tables, bearings preceded by B)

Table 2 Tolerances of Cones (CLASS K)

Units : μm

Nominal Bore Diameter d (mm)		ϵ_{dmp}		V_{dp}	V_{dmp}	K_{ia}
over	incl.	high	low	max.	max.	max.
10	18	0	-12	12	9	15
18	30	0	-12	12	9	18
30	50	0	-12	12	9	20
50	80	0	-15	15	11	25
80	120	0	-20	20	15	30
120	180	0	-25	25	19	35
180	250	0	-30	30	23	50
250	315	0	-35	35	26	60
315	400	0	-40	40	30	70

Table 3 Tolerances of Cups (CLASS K)

Units : μm

Nominal Outside Diameter D (mm)		ϵ_{Dmp}		V_{Dp}	V_{Dmp}	K_{ea}
over	incl.	high	low	max.	max.	max.
18	30	0	-12	12	9	18
30	50	0	-14	14	11	20
50	80	0	-16	16	12	25
80	120	0	-18	18	14	35
120	150	0	-20	20	15	40
150	180	0	-25	25	19	45
180	250	0	-30	30	23	50
250	315	0	-35	35	26	60
315	400	0	-40	40	30	70
400	500	0	-45	45	34	80

Table 4 Tolerances of Effective Widths of Cone Assemblies and Cups and Overall Width (CLASS K)

Units : μm

Nominal Bore Diameter d (mm)		Effective Width Deviation of Cone Assembly & T_{1s}		Effective Width Deviation of Cup & T_{2s}		Overall Width Deviation & T_s	
over	incl.	high	low	high	low	high	low
10	80	+100	0	+100	0	+200	0
80	120	+100	-100	+100	-100	+200	-200
120	315	+150	-150	+200	-100	+350	-250
315	400	+200	-200	+200	-200	+400	-400

2. Bearings for Front Axles of Automobiles (In the bearing tables, those preceded by t)

Table 5 Tolerances of Bore Diameter and Overall Width

Units : μm

Nominal Bore Diameter d		Bore Diameter Deviation & d_s		Overall Width Deviation & T_s	
over (mm)	incl. (mm)	high	low	high	low
—	76.200 3.0000	+20	0	+356	0



The tolerances for outside diameter and those for radial runout of the cones and cups conform to Table 7.4.2 (Pages A136 and A137)

3. Special Chamfer Dimensions

For bearings marked "spec." in the column of r in the bearing tables, the chamfer dimension of the cone back-face side is as shown on the following figure.

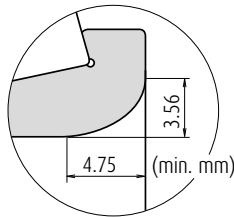

Tapered Roller Bearings

RECOMMENDED FITS

	Table	Page
Metric Design Tapered Roller Bearings	8.3	A 164
	8.5	A 165
Inch Design Tapered Roller Bearings	8.7	A 166
	8.8	A 167

INTERNAL CLEARANCE

	Table	Page
Metric Design Tapered Roller Bearings (Matched and Double-Row)	8.17	A 173
Inch Design Tapered Roller Bearings (Matched and Double-Row)	8.17	A 173

DIMENSIONS RELATED TO MOUNTING

The dimensions related to mounting tapered roller bearings are listed in the bearing tables. Since the cages protrude from the ring faces of tapered roller bearings, please use care when designing shafts and housings.

When heavy axial loads are imposed, the shaft shoulder dimensions and strength must be sufficient to support the cone rib.

PERMISSIBLE MISALIGNMENT

The permissible misalignment angle for tapered roller bearings is approximately 0.0009 radian (3').

LIMITING SPEEDS (GREASE/OIL)

The limiting speeds for grease and oil lubrication listed in the bearing tables should be adjusted depending on the bearing load condition. Also, higher speeds are attainable by making changes in the lubrication method, cage design, etc. Refer to page A098 for detailed information.

PRECAUTIONS FOR USE OF TAPERED ROLLER BEARINGS

1. If the load on tapered roller bearings becomes too small, or if the ratio of the axial and radial loads for matched bearings exceeds 'e' (e is listed in the bearing tables) during operation, slippage between the rollers and raceways occurs, which may result in smearing. Especially with large bearings since the weight of the rollers and cage is high. If such load conditions are expected, please contact NSK for selection of the bearings.
2. Confirm the dimension of "Abutment and Fillet Dimensions" of D_a , D_b , S_a , S_b at the time of the HR series adoption.



Tapered Roller Bearings

TECHNICAL DATA

Free Space of Tapered Roller Bearings

The tapered roller bearing can carry radial load and uni-direction axial loads. It offers high capacity. This type of bearing is used widely in machine systems with relatively severe loading conditions in various combinations by opposing or combining single-row bearings.

With a view towards easier maintenance and inspection, this kind of bearing is lubricated with grease in most cases. It is important to select a grease appropriate to the operating conditions and to use the proper amount of grease for the housing internal space. As a reference, the free space of a tapered roller bearing is shown in Table 6.

The free space of a tapered roller bearing is the space (shaded portion) of the bearing outer volume less the inner and outer rings and cage, as shown in Fig. 1. The bearing is filled so that grease reaches the inner ring rib surface and pocket surface in sufficient amount.

Due attention must also be paid to the grease filling amount and state, especially if grease leakage occurs or maintenance of low running torque is important.

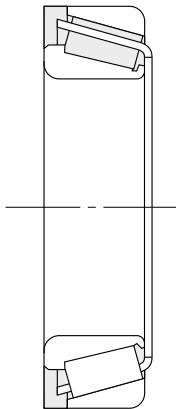

Fig. 1 Free Space of Tapered Roller Bearing

Table 6 Free Space of Tapered Roller Bearing

Bearing bore No.	Bearing free space	
	Bearing series	
	HR329-J	HR320-XJ
02	—	—
03	—	—
04	—	3.5
/22	—	3.6
05	—	3.7
/28	—	5.3
06	—	6.2
/32	—	6.6
07	4.0	7.5
08	5.8	9.1
09	—	11
10	—	12
11	8.8	19
12	9.0	20
13	—	21
14	17	29
15	—	30
16	—	40
17	—	43
18	28	58
19	29	60
20	37	64

Units : cm³

Bearing free space							
Bearing series							
HR330-J	HR331-J	HR302-J	HR322-J	HR332-J	HR303-J	HR303-DJ	HR323-J
—	—	—	—	—	4.5	—	—
—	—	3.3	4.3	—	5.7	—	—
—	—	5.3	6.6	—	7.2	—	9.2
—	—	—	7.3	—	9.1	—	—
4.3	—	6.3	7.4	7.5	11	13	15
—	—	8.8	9.8	10	16	—	—
6.7	—	9.2	11	12	18	21	23
—	—	11	13	14	20	—	—
8.9	—	13	17	18	23	26	35
11	—	18	23	25	31	35	45
—	18	22	24	26	41	48	58
15	20	23	26	29	55	59	77
21	29	30	36	40	72	78	99
23	—	39	47	53	88	95	130
25	—	45	62	65	110	120	150
33	—	53	67	69	130	150	190
34	—	58	73	74	160	180	230
—	—	75	91	100	200	200	270
49	76	92	120	130	230	250	320
—	110	110	150	—	260	310	370
—	—	140	170	—	310	350	430
—	150	160	210	240	380	460	580



Single-Row Tapered Roller Bearings

Bore Diameter 15 – 28 mm

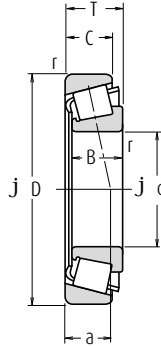

Boundary Dimensions (mm)							Basic Load Ratings (N)		Limiting Speeds (min ⁻¹)	
d	D	T	B	C	Cone	Cup	C _r	C _{0r}	Grease	Oil
					r	r				
					min.					
15	35	11.75	11	10	0.6	0.6	14 800	13 200	11 000	15 000
	42	14.25	13	11	1	1	23 600	21 100	9 500	13 000
	40	13.25	12	11	1	1	20 100	19 900	9 500	13 000
17	40	17.25	16	14	1	1	27 100	28 000	9 500	13 000
	47	15.25	14	12	1	1	29 200	26 700	8 500	12 000
	47	15.25	14	10.5	1	1	22 000	20 300	8 000	11 000
20	47	20.25	19	16	1	1	37 500	36 500	8 500	11 000
	42	15	15	12	0.6	0.6	24 600	27 400	9 000	12 000
	47	15.25	14	12	1	1	27 900	28 500	8 000	11 000
22	47	15.25	14	12	0.3	1	23 900	24 000	8 000	11 000
	47	19.25	18	15	1	1	35 500	37 500	8 500	11 000
	47	19.25	18	15	1	1	31 500	33 500	8 000	11 000
25	52	16.25	15	13	1.5	1.5	35 000	33 500	7 500	10 000
	52	16.25	15	12	1.5	1.5	25 300	24 500	7 100	10 000
	52	22.25	21	18	1.5	1.5	45 500	47 500	8 000	11 000
28	44	15	15	11.5	0.6	0.6	25 600	29 400	8 500	11 000
	50	15.25	14	12	1	1	29 200	30 500	7 500	10 000
	50	15.25	14	12	1	1	27 200	29 500	7 500	10 000
30	50	19.25	18	15	1	1	36 500	40 500	7 500	11 000
	50	19.25	18	15	1	1	33 500	39 500	7 500	10 000
	56	17.25	16	14	1.5	1.5	37 000	36 500	7 100	9 500
35	56	17.25	16	13	1.5	1.5	34 500	34 000	6 700	9 500
	47	15	15	11.5	0.6	0.6	27 400	33 000	8 000	11 000
	47	17	17	14	0.6	0.6	31 000	38 000	8 000	11 000
40	52	16.25	15	13	1	1	32 000	35 000	7 100	10 000
	52	16.25	15	12	1	1	28 100	31 500	9 700	9 500
	52	19.25	18	16	1	1	40 000	45 000	7 100	10 000
45	52	19.25	18	15	1	1	35 000	42 000	7 100	9 500
	52	22	22	18	1	1	47 500	56 500	7 500	10 000
	62	18.25	17	15	1.5	1.5	47 500	46 000	6 300	8 500
50	62	18.25	17	14	1.5	1.5	42 000	45 000	6 000	8 500
	62	18.25	17	13	1.5	1.5	38 000	40 500	5 600	8 000
	62	18.25	17	13	1.5	1.5	38 000	40 500	5 600	8 000
55	62	25.25	24	20	1.5	1.5	62 500	66 000	6 300	8 500
	52	16	16	12	1	1	32 000	39 000	7 100	9 500
	58	17.25	16	14	1	1	39 500	41 500	6 300	9 000
60	58	17.25	16	12	1	1	34 000	38 500	6 300	8 500
	58	20.25	19	16	1	1	47 500	54 000	6 300	9 000
	58	20.25	19	16	1	1	42 000	49 500	6 300	9 000
65	68	19.75	18	15	1.5	1.5	55 000	55 500	6 000	8 000
	68	19.75	18	14	1.5	1.5	49 500	50 500	5 600	7 500

Remark The suffix C represents medium-angle tapered roller bearings. Since they are designed for specific applications, please consult NSK when using bearings with suffix C.

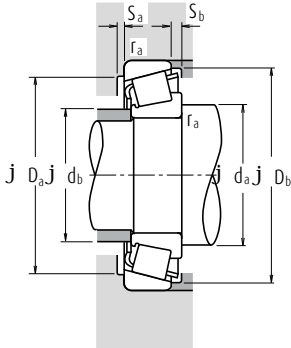

Dynamic Equivalent Load $P = XF_r + YF_a$

$F_a/F_r \leq e$		$F_a/F_r > e$	
X	Y	X	Y
1	0	0.4	Y_1

Static Equivalent Load

$$P_0 = 0.5F_r + Y_0F_a$$

When $F_r > 0.5F_r + Y_0F_a$, use $P_0 = F_r$

The values of e , Y_1 and Y_0 are given in the table below.

Bearing Numbers	ISO355 Dimension Series	Abutment and Fillet Dimensions (mm)									Eff. Load Centers (mm)	Constant	Axial Load Factors		Mass (kg)
		d_a		d_b		D_a		Cone		Cup			Y_1	Y_0	
		approx.	min.	max.	min.	max.	S_a	S_b	r_a	max.					
30202	—	23	19	30	30	33	2	1.5	0.6	0.6	8.2	0.32	1.9	1.0	0.053
HR 30302 J	2FB	24	22	36	36	38.5	2	3	1	1	9.5	0.29	2.1	1.2	0.098
HR 30203 J	2DB	26	23	34	34	37.5	2	2	1	1	9.7	0.35	1.7	0.96	0.079
HR 32203 J	2DD	26	22	34	34	37	2	3	1	1	11.2	0.31	1.9	1.1	0.103
HR 30303 J	2FB	26	24	41	40	43	2	3	1	1	10.4	0.29	2.1	1.2	0.134
30303 D	—	29	23	41	34	44	2	4.5	1	1	15.4	0.81	0.74	0.41	0.129
HR 32303 J	2FD	28	23	41	39	43	2	4	1	1	12.5	0.29	2.1	1.2	0.178
HR 32004 XJ	3CC	28	24	37	35	40	3	3	0.6	0.6	10.6	0.37	1.6	0.888	0.097
HR 30204 J	2DB	29	27	41	40	44	2	3	1	1	11.0	0.35	1.7	0.96	0.127
HR 30204 C-A	—	29	26	41	37	44	2	3	0.3	1	13.0	0.55	1.1	0.60	0.126
HR 32204 J	2DD	29	25	41	38	44.5	3	4	1	1	12.6	0.33	1.8	1.0	0.161
HR 32204 CJ	5DD	29	25	41	36	44	2	4	1	1	14.5	0.52	1.2	0.64	0.166
HR 30304 J	2FB	31	27	44	44	47.5	2	3	1.5	1.5	11.6	0.30	2.0	1.1	0.172
30304 D	—	34	26	43	37	49	2	4	1.5	1.5	16.7	0.81	0.74	0.41	0.168
HR 32304 J	2FD	33	26	43	42	48	3	4	1.5	1.5	13.9	0.30	2.0	1.1	0.241
HR 320/22 XJ	3CC	30	27	39	37	42	3	3.5	0.6	0.6	11.1	0.40	1.5	0.83	0.103
HR 302/22	—	31	29	44	42	47	2	3	1	1	11.6	0.37	1.6	0.90	0.139
HR 302/22 C	—	31	29	44	40	47	2	3	1	1	13.0	0.49	1.2	0.67	0.144
HR 322/22	—	31	28	44	41	47	2	4	1	1	13.5	0.37	1.6	0.89	0.18
HR 322/22 C	—	31	29	44	39	48	2	4	1	1	15.2	0.51	1.2	0.65	0.185
HR 303/22	—	33	30	47	46	50	2	3	1.5	1.5	12.4	0.32	1.9	1.0	0.208
HR 303/22 C	—	33	30	47	44	52.5	3	4	1.5	1.5	15.9	0.59	1.0	0.56	0.207
HR 32005 XJ	4CC	33	30	42	40	45	3	3.5	0.6	0.6	11.8	0.43	1.4	0.77	0.116
HR 33005 J	2CE	33	29	42	41	44	3	3	0.6	0.6	11.0	0.29	2.1	1.1	0.131
HR 30205 J	3CC	34	31	46	44	48.5	2	3	1	1	12.7	0.37	1.6	0.88	0.157
HR 30205 C	—	34	32	46	43	49.5	2	4	1	1	14.4	0.53	1.1	0.62	0.155
HR 32205 J	2CD	34	30	46	44	50	2	3	1	1	13.5	0.36	1.7	0.92	0.189
HR 32205 C	—	34	30	46	40	50	2	4	1	1	15.8	0.53	1.1	0.62	0.19
HR 33205 J	2DE	34	29	46	43	49.5	4	4	1	1	14.1	0.35	1.7	0.94	0.221
HR 30305 J	2FB	36	34	54	54	57	2	3	1.5	1.5	13.2	0.30	2.0	1.1	0.27
HR 30305 C	—	36	35	53	49	58.5	3	4	1.5	1.5	16.4	0.55	1.1	0.60	0.276
HR 30305 DJ	(7FB)	39	34	53	47	59	2	5	1.5	1.5	19.9	0.83	0.73	0.40	0.265
HR 31305 J	7FB	39	33	53	47	59	3	5	1.5	1.5	19.9	0.83	0.73	0.40	0.265
HR 32305 J	2FD	38	32	53	51	57	3	5	1.5	1.5	15.6	0.30	2.0	1.1	0.376
HR 320/28 XJ	4CC	37	33	46	44	50	3	4	1	1	12.8	0.43	1.4	0.77	0.146
HR 302/28	—	37	34	52	50	55	2	3	1	1	13.2	0.35	1.7	0.93	0.203
HR 302/28 C	—	37	34	52	48	54	2	5	1	1	16.9	0.64	0.94	0.52	0.198
HR 322/28	—	37	34	52	49	55	2	4	1	1	14.6	0.37	1.6	0.89	0.243
HR 322/28 CJ	5DD	37	33	52	45	55	2	4	1	1	16.8	0.56	1.1	0.59	0.251
HR 303/28	—	39	37	59	58	61	2	4.5	1.5	1.5	14.5	0.31	1.9	1.1	0.341
HR 303/28 C	—	39	38	59	57	63	3	5.5	1.5	1.5	17.4	0.52	1.2	0.64	0.335



Single-Row Tapered Roller Bearings

Bore Diameter 30 – 35 mm

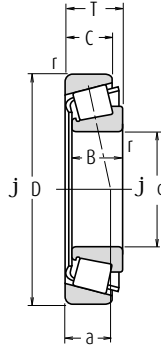

d	Boundary Dimensions (mm)					Basic Load Ratings (N)		Limiting Speeds (min ⁻¹)		
	D	T	B	C	Cone r min.	Cup r	C _r	C _{0r}	Grease	Oil
30	47	12	12	9	0.3	0.3	17 600	24 400	7 500	10 000
	55	17	17	13	1	1	36 000	44 500	6 700	9 000
	55	20	20	16	1	1	42 000	54 000	6 700	9 000
	62	17.25	16	14	1	1	43 000	47 500	6 000	8 000
	62	17.25	16	12	1	1	35 500	37 000	5 600	7 500
	62	21.25	20	17	1	1	52 000	60 000	6 000	8 500
	62	21.25	20	16	1	1	48 000	56 000	6 000	8 000
	62	25	25	19.5	1	1	66 500	79 500	6 000	8 000
	72	20.75	19	16	1.5	1.5	59 500	60 000	5 300	7 500
	72	20.75	19	14	1.5	1.5	56 500	55 500	5 300	7 100
	72	20.75	19	14	1.5	1.5	49 000	52 500	4 800	6 700
	72	20.75	19	14	1.5	1.5	49 000	52 500	4 800	6 800
	72	28.75	27	23	1.5	1.5	80 000	88 500	5 600	7 500
	72	28.75	27	23	1.5	1.5	76 000	86 500	5 600	7 500
32	58	17	17	13	1	1	37 500	47 000	6 300	8 500
	58	21	20	16	1	1	41 000	50 000	6 300	8 500
	65	18.25	17	15	1	1	48 500	54 000	5 600	8 000
	65	18.25	17	14	1	1	45 500	52 500	5 600	7 500
	65	22.25	21	18	1	1	56 000	65 000	6 000	8 000
	65	22.25	21	17	1	1	49 500	60 000	5 600	7 500
	65	26	26	20.5	1	1	70 000	86 500	5 600	8 000
35	75	21.75	20	17	1.5	1.5	56 000	56 000	5 300	7 100
	55	14	14	11.5	0.6	0.6	27 400	39 000	6 300	8 500
	62	18	18	14	1	1	43 500	55 500	5 600	8 000
	62	21	21	17	1	1	49 000	65 000	5 600	8 000
	72	18.25	17	15	1.5	1.5	54 000	59 500	5 300	7 100
	72	18.25	17	13	1.5	1.5	47 000	54 500	5 000	6 700
	72	24.25	23	19	1.5	1.5	70 500	83 500	5 300	7 100
	72	24.25	23	18	1.5	1.5	60 500	71 500	5 000	7 100
	72	28	28	22	1.5	1.5	86 500	108 000	5 300	7 100
	80	22.75	21	18	2	1.5	76 000	79 000	4 800	6 700
	80	22.75	21	16	2	1.5	68 000	70 500	4 800	6 300
	80	22.75	21	15	2	1.5	62 000	68 000	4 300	6 000
	80	22.75	21	15	2	1.5	62 000	68 000	4 300	6 000
80	32.75	31	25	2	1.5	99 000	111 000	5 000	6 700	

Remark The suffix C represents medium-angle tapered roller bearings. Since they are designed for specific applications, please consult NSK when using bearings with suffix C.

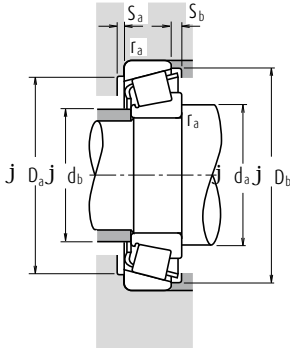

Dynamic Equivalent Load $P = X F_r + Y F_a$

$F_a/F_r \leq e$		$F_a/F_r > e$	
X	Y	X	Y
1	0	0.4	Y_1

Static Equivalent Load

$$P_0 = 0.5 F_r + Y_0 F_a$$

When $F_r > 0.5 F_r + Y_0 F_a$, use $P_0 = F_r$

The values of e , Y_1 and Y_0 are given in the table below.

Bearing Numbers	ISO355 Dimension Series	Abutment and Fillet Dimensions (mm)										Eff. Load Centers (mm)	Constant	Axial Load Factors		Mass (kg)				
		d_a		d_b		D_a		D_b		Cone				Cup	a		e	Y_1	Y_0	approx.
		min.	max.	min.	max.	min.	max.	min.	max.	S_a	S_b									
HR 32906 J	2BD	34	34	44	42	44	3	3	0.3	0.3	9.2	0.32	1.9	1.0	0.074					
HR 32006 XJ	4CC	39	35	49	47	53	3	4	1	1	13.5	0.43	1.4	0.77	0.172					
HR 33006 J	2CE	39	35	49	48	52	3	4	1	1	13.1	0.29	2.1	1.1	0.208					
HR 30206 J	3DB	39	37	56	52	58	2	3	1	1	13.9	0.37	1.6	0.88	0.238					
HR 30206 C	—	39	36	56	49	59	2	5	1	1	17.8	0.68	0.88	0.49	0.221					
HR 32206 J	3DC	39	36	56	51	58.5	2	4	1	1	15.4	0.37	1.6	0.88	0.297					
HR 32206 C	—	39	35	56	48	59	2	5	1	1	17.8	0.55	1.1	0.60	0.293					
HR 33206 J	2DE	39	35	56	52	59.5	5	5.5	1	1	16.1	0.34	1.8	0.97	0.355					
HR 30306 J	2FB	41	40	63	62	66	3	4.5	1.5	1.5	15.1	0.32	1.9	1.1	0.403					
HR 30306 C	—	41	38	63	59	67	3	6.5	1.5	1.5	18.5	0.55	1.1	0.60	0.383					
HR 30306 DJ	(7FB)	44	40	63	55	68	3	6.5	1.5	1.5	23.1	0.83	0.73	0.40	0.393					
HR 31306 J	7FB	44	40	63	55	68	3	6.5	1.5	1.5	23.1	0.83	0.73	0.40	0.393					
HR 32306 J	2FD	43	38	63	59	66	3	5.5	1.5	1.5	18.0	0.32	1.9	1.1	0.57					
HR 32306 CJ	5FD	43	36	63	54	68	3	5.5	1.5	1.5	22.0	0.55	1.1	0.60	0.583					
HR 320/32 XJ	4CC	41	37	52	49	55	3	4	1	1	14.2	0.45	1.3	0.73	0.191					
330/32	—	41	37	52	50	55	2	4	1	1	13.8	0.31	1.9	1.1	0.225					
HR 302/32	—	41	39	59	56	61	3	3	1	1	14.7	0.37	1.6	0.88	0.277					
HR 302/32 C	—	41	39	59	54	62	3	4	1	1	16.9	0.55	1.1	0.60	0.273					
HR 322/32	—	41	38	59	54	61	3	4	1	1	15.9	0.37	1.6	0.88	0.336					
HR 322/32 C	—	41	39	59	51	62	3	5	1	1	20.2	0.59	1.0	0.56	0.335					
HR 332/32 J	2DE	41	38	59	55	62	5	5.5	1	1	17.0	0.35	1.7	0.95	0.40					
303/32	—	44	42	66	64	68	3	4.5	1.5	1.5	15.9	0.33	1.8	1.0	0.435					
HR 32907 J	2BD	43	40	50	50	52.5	3	2.5	0.6	0.6	10.7	0.29	2.1	1.1	0.123					
HR 32007 XJ	4CC	44	40	56	54	60	4	4	1	1	15.0	0.45	1.3	0.73	0.229					
HR 33007 J	2CE	44	40	56	55	59	4	4	1	1	14.1	0.31	2.0	1.1	0.267					
HR 30207 J	3DB	46	43	63	62	67	3	3	1.5	1.5	15.0	0.37	1.6	0.88	0.34					
HR 30207 C	—	46	44	63	59	68	3	5	1.5	1.5	19.6	0.66	0.91	0.50	0.331					
HR 32207 J	3DC	46	42	63	61	67.5	3	5	1.5	1.5	17.9	0.37	1.6	0.88	0.456					
HR 32207 C	—	46	42	63	58	68.5	3	6	1.5	1.5	20.6	0.55	1.1	0.60	0.442					
HR 33207 J	2DE	46	41	63	61	68	5	6	1.5	1.5	18.3	0.35	1.7	0.93	0.54					
HR 30307 J	2FB	47	45	71	69	74	3	4.5	2	1.5	16.7	0.32	1.9	1.1	0.538					
HR 30307 C	—	47	44	71	65	74	3	6.5	2	1.5	20.3	0.55	1.1	0.60	0.518					
HR 30307 DJ	7FB	51	44	71	62	77	3	7.5	2	1.5	25.2	0.83	0.73	0.40	0.519					
HR 31307 J	7FB	51	44	71	62	77	3	7.5	2	1.5	25.2	0.83	0.73	0.40	0.52					
HR 32307 J	2FE	49	43	71	66	74	3	7.5	2	1.5	20.7	0.32	1.9	1.1	0.765					



Single-Row Tapered Roller Bearings

Bore Diameter 40 - 50 mm

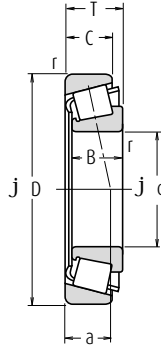

d	Boundary Dimensions (mm)					Cone		Basic Load Ratings (N)		Limiting Speeds (min ⁻¹)	
	D	T	B	C		Cup	C _r	C _{0r}	Grease	Oil	
					r min.	r min.					
40	62	15	15	12	0.6	0.6	34 000	47 000	5 600	7 500	
	68	19	19	14.5	1	1	53 000	71 000	5 300	7 100	
	68	22	22	18	1	1	59 000	81 500	5 300	7 100	
	75	26	26	20.5	1.5	1.5	78 500	101 000	4 800	6 700	
	80	19.75	18	16	1.5	1.5	63 500	70 000	4 800	6 300	
	80	24.75	23	19	1.5	1.5	77 000	90 500	4 800	6 300	
	80	24.75	23	19	1.5	1.5	74 000	90 500	4 500	6 300	
	80	32	32	25	1.5	1.5	107 000	137 000	4 800	6 300	
	90	25.25	23	20	2	1.5	90 500	101 000	4 300	5 600	
	90	25.25	23	18	2	1.5	84 500	93 500	4 300	5 600	
	90	25.25	23	17	2	1.5	80 000	89 500	3 800	5 300	
	90	25.25	23	17	2	1.5	80 000	89 500	3 800	5 300	
	90	35.25	33	27	2	1.5	120 000	145 000	4 300	6 000	
	45	68	15	15	12	0.6	0.6	34 500	50 500	5 000	6 700
75		20	20	15.5	1	1	60 000	83 000	4 500	6 300	
75		24	24	19	1	1	69 000	99 000	4 800	6 300	
80		26	26	20.5	1.5	1.5	84 000	113 000	4 500	6 000	
85		20.75	19	16	1.5	1.5	68 500	79 500	4 300	6 000	
85		24.75	23	19	1.5	1.5	83 000	102 000	4 300	6 000	
85		24.75	23	19	1.5	1.5	75 500	95 500	4 300	5 600	
85		32	32	25	1.5	1.5	111 000	147 000	4 300	6 000	
95		29	26.5	20	2.5	2.5	88 500	109 000	3 600	5 000	
95		36	35	30	2.5	2.5	139 000	174 000	4 000	5 300	
100		27.25	25	22	2	1.5	112 000	127 000	3 800	5 300	
100		27.25	25	18	2	1.5	95 500	109 000	3 400	4 800	
100		27.25	25	18	2	1.5	95 500	109 000	3 400	4 800	
100		38.25	36	30	2	1.5	144 000	177 000	3 800	5 300	
50	100	36	35	30	2.5	2.5	144 000	185 000	3 800	5 000	
	72	15	15	12	0.6	0.6	36 000	54 000	4 500	6 300	
	80	20	20	15.5	1	1	61 000	87 000	4 300	6 000	
	80	24	24	19	1	1	70 500	104 000	4 300	6 000	
	85	26	26	20	1.5	1.5	89 000	126 000	4 300	5 600	
	90	21.75	20	17	1.5	1.5	76 000	91 500	4 000	5 300	
	90	24.75	23	19	1.5	1.5	87 500	109 000	4 000	5 300	
	90	24.75	23	18	1.5	1.5	77 500	102 000	3 800	5 300	
	90	32	32	24.5	1.5	1.5	118 000	165 000	4 000	5 300	
	105	32	29	22	3	3	109 000	133 000	3 200	4 500	
	110	29.25	27	23	2.5	2	130 000	148 000	3 400	4 800	
	110	29.25	27	19	2.5	2	114 000	132 000	3 200	4 300	
	110	29.25	27	19	2.5	2	114 000	132 000	3 200	4 300	
	110	42.25	40	33	2.5	2	176 000	220 000	3 600	4 800	
110	42.25	40	33	2.5	2	164 000	218 000	3 400	4 800		

Remark The suffix C represents medium-angle tapered roller bearings. Since they are designed for specific applications, please consult NSK when using bearings with suffix C.

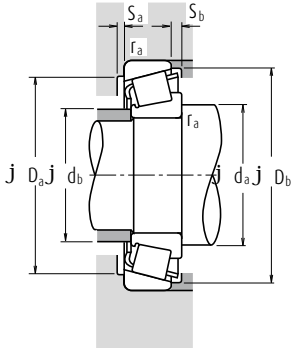

Dynamic Equivalent Load $P = X F_r + Y F_a$

$F_a/F_r \leq e$		$F_a/F_r > e$	
X	Y	X	Y
1	0	0.4	Y_1

Static Equivalent Load

$$P_0 = 0.5 F_r + Y_0 F_a$$

When $F_r > 0.5 F_r + Y_0 F_a$, use $P_0 = F_r$

The values of e , Y_1 and Y_0 are given in the table below.

Bearing Numbers	ISO355 Dimension Series	Abutment and Fillet Dimensions (mm)								Eff. Load Centers (mm)	Constant	Axial Load Factors		Mass (kg)	
		Cone				Cup						Y_1	Y_0		
		d_a approx.	d_b min.	D_a max.	D_b min.	S_a min.	S_b min.	r_a max.	r_b max.						approx.
HR 32908 J	2BC	48	44	57	57	59	3	3	0.6	0.6	11.5	0.29	2.1	1.1	0.161
HR 32008 XJ	3CD	49	45	62	60	65.5	4	4.5	1	1	15.0	0.38	1.6	0.87	0.28
HR 33008 J	2BE	49	45	62	61	65	4	4	1	1	14.6	0.28	2.1	1.2	0.322
HR 33108 J	2CE	51	46	66	65	71	4	5.5	1.5	1.5	18.0	0.36	1.7	0.93	0.503
HR 30208 J	3DB	51	48	71	69	75	3	3.5	1.5	1.5	16.6	0.37	1.6	0.88	0.437
HR 32208 J	3DC	51	48	71	68	75	3	5.5	1.5	1.5	18.9	0.37	1.6	0.88	0.548
HR 32208 CJ	5DC	51	47	71	65	76	3	5.5	1.5	1.5	21.9	0.55	1.1	0.60	0.558
HR 33208 J	2DE	51	46	71	67	76	5	7	1.5	1.5	20.8	0.36	1.7	0.92	0.744
HR 30308 J	2FB	52	52	81	76	82	3	5	2	1.5	19.5	0.35	1.7	0.96	0.758
HR 30308 C	—	52	50	81	72	84	3	7	2	1.5	22.8	0.53	1.1	0.62	0.735
HR 30308 DJ	7FB	56	50	81	70	87	3	8	2	1.5	28.7	0.83	0.73	0.40	0.728
HR 31308 J	7FB	56	50	81	70	87	3	8	2	1.5	28.7	0.83	0.73	0.40	0.728
HR 32308 J	2FD	54	50	81	73	82	3	8	2	1.5	23.4	0.35	1.7	0.96	1.05
HR 32909 J	2BC	53	50	63	62	64	3	3	0.6	0.6	12.3	0.32	1.9	1.0	0.187
HR 32009 XJ	3CC	54	51	69	67	72	4	4.5	1	1	16.6	0.39	1.5	0.84	0.354
HR 33009 J	2CE	54	51	69	67	71	4	5	1	1	16.3	0.29	2.0	1.1	0.414
HR 33109 J	3CE	56	51	71	69	77	4	5.5	1.5	1.5	19.1	0.38	1.6	0.86	0.552
HR 30209 J	3DB	56	53	76	74	80	3	4.5	1.5	1.5	18.3	0.41	1.5	0.81	0.488
HR 32209 J	3DC	56	53	76	73	81	3	5.5	1.5	1.5	20.1	0.41	1.5	0.81	0.602
HR 32209 CJ	5DC	56	52	76	70	82	3	5.5	1.5	1.5	23.6	0.59	1.0	0.56	0.603
HR 33209 J	3DE	56	51	76	72	81	5	7	1.5	1.5	22.0	0.39	1.6	0.86	0.817
T7 FC045	7FC	60	53	83	71	91	3	9	2	2	32.1	0.87	0.69	0.38	0.918
T2 ED045	2ED	60	54	83	79	89	5	6	2	2	23.5	0.32	1.9	1.02	1.22
HR 30309 J	2FB	57	58	91	86	93	3	5	2	1.5	21.1	0.35	1.7	0.96	1.01
HR 30309 DJ	7FB	61	57	91	79	96	3	9	2	1.5	31.5	0.83	0.73	0.40	0.957
HR 31309 J	7FB	61	57	91	79	96	3	9	2	1.5	31.5	0.83	0.73	0.40	0.947
HR 32309 J	2FD	59	56	91	82	93	3	8	2	1.5	25.0	0.35	1.7	0.96	1.42
T2 ED050	2ED	65	59	88	83	94	6	6	2	2	24.2	0.34	1.8	0.96	1.3
HR 32910 J	2BC	58	54	67	66	69	3	3	0.6	0.6	13.5	0.34	1.8	0.97	0.193
HR 32010 XJ	3CC	59	56	74	71	77	4	4.5	1	1	17.9	0.42	1.4	0.78	0.38
HR 33010 J	2CE	59	55	74	71	76	4	5	1	1	17.4	0.32	1.9	1.0	0.452
HR 33110 J	3CE	61	56	76	74	82	4	6	1.5	1.5	20.3	0.41	1.5	0.8	0.597
HR 30210 J	3DB	61	58	81	79	85	3	4.5	1.5	1.5	19.6	0.42	1.4	0.79	0.557
HR 32210 J	3DC	61	57	81	78	86	3	5.5	1.5	1.5	21.0	0.42	1.4	0.79	0.642
HR 32210 CJ	5DC	61	58	81	76	87	3	6.5	1.5	1.5	24.6	0.59	1.0	0.56	0.655
HR 33210 J	3DE	61	56	81	76	87	5	7.5	1.5	1.5	23.2	0.41	1.5	0.80	0.867
T7 FC050	7FC	74	59	91	78	100	5	10	2.5	2.5	36.4	0.87	0.69	0.38	1.22
HR 30310 J	2FB	65	65	100	95	102	3	6	2	2	23.1	0.35	1.7	0.96	1.28
HR 30310 DJ	7FB	70	62	100	87	105	3	10	2	2	34.3	0.83	0.73	0.40	1.26
HR 31310 J	7FB	70	62	100	87	105	3	10	2	2	34.3	0.83	0.73	0.40	1.26
HR 32310 J	2FD	68	62	100	91	102	3	9	2	2	28.0	0.35	1.7	0.96	1.88
HR 32310 CJ	5FD	68	59	100	82	103	3	9	2	2	32.8	0.55	1.1	0.60	1.93



Single-Row Tapered Roller Bearings

Bore Diameter 55 – 65 mm

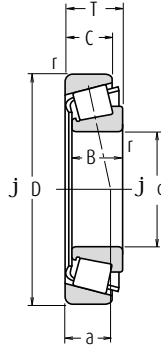

Boundary Dimensions (mm)							Basic Load Ratings (N)		Limiting Speeds (min ⁻¹)	
d	D	T	B	C	Cone	Cup	C _r	C _{0r}	Grease	Oil
					r	r				
					min.					
55	80	17	17	14	1	1	45 500	74 500	4 300	5 600
	90	23	23	17.5	1.5	1.5	81 500	117 000	3 800	5 300
	90	27	27	21	1.5	1.5	91 500	138 000	3 800	5 300
	95	30	30	23	1.5	1.5	112 000	158 000	3 800	5 000
	100	22.75	21	18	2	1.5	94 500	113 000	3 600	5 000
	100	26.75	25	21	2	1.5	110 000	137 000	3 600	5 000
	100	35	35	27	2	1.5	141 000	193 000	3 600	5 000
	115	34	31	23.5	3	3	126 000	164 000	3 000	4 300
	120	31.5	29	25	2.5	2	150 000	171 000	3 200	4 300
	120	31.5	29	21	2.5	2	131 000	153 000	2 800	4 000
	120	31.5	29	21	2.5	2	131 000	153 000	2 800	4 000
	120	45.5	43	35	2.5	2	204 000	258 000	3 200	4 300
120	45.5	43	35	2.5	2	195 000	262 000	3 200	4 300	
60	85	17	17	14	1	1	49 000	84 500	3 800	5 300
	95	23	23	17.5	1.5	1.5	85 500	127 000	3 600	5 000
	95	27	27	21	1.5	1.5	96 000	150 000	3 600	5 000
	100	30	30	23	1.5	1.5	115 000	166 000	3 400	4 800
	110	23.75	22	19	2	1.5	104 000	123 000	3 400	4 500
	110	29.75	28	24	2	1.5	131 000	167 000	3 400	4 500
	110	38	38	29	2	1.5	166 000	231 000	3 400	4 500
	125	37	33.5	26	3	3	151 000	197 000	2 800	3 800
	130	33.5	31	26	3	2.5	174 000	201 000	3 000	4 000
	130	33.5	31	22	3	2.5	151 000	177 000	2 600	3 800
	130	33.5	31	22	3	2.5	151 000	177 000	2 600	3 800
	130	48.5	46	37	3	2.5	233 000	295 000	3 000	4 000
130	48.5	46	35	3	2.5	196 000	249 000	2 800	3 800	
65	90	17	17	14	1	1	49 000	86 500	3 600	5 000
	100	23	23	17.5	1.5	1.5	86 500	132 000	3 400	4 500
	100	27	27	21	1.5	1.5	97 500	156 000	3 400	4 500
	110	34	34	26.5	1.5	1.5	148 000	218 000	3 200	4 300
	120	24.75	23	20	2	1.5	122 000	151 000	3 000	4 000
	120	32.75	31	27	2	1.5	157 000	202 000	3 000	4 000
	120	41	41	32	2	1.5	202 000	282 000	3 000	4 000
	140	36	33	28	3	2.5	200 000	233 000	2 600	3 600
	140	36	33	23	3	2.5	173 000	205 000	2 400	3 400
	140	36	33	23	3	2.5	173 000	205 000	2 400	3 400
	140	51	48	39	3	2.5	267 000	340 000	2 800	3 800

Remark The suffix C represents medium-angle tapered roller bearings. Since they are designed for specific applications, please consult NSK when using bearings with suffix C.

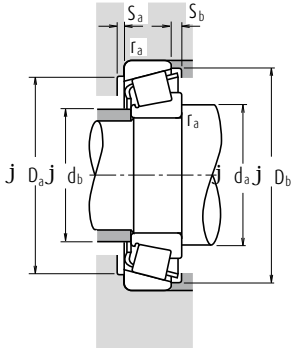

Dynamic Equivalent Load $P = X F_r + Y F_a$

$F_a/F_r \leq e$		$F_a/F_r > e$	
X	Y	X	Y
1	0	0.4	Y_1

Static Equivalent Load

$$P_0 = 0.5 F_r + Y_0 F_a$$

When $F_r > 0.5 F_r + Y_0 F_a$, use $P_0 = F_r$

The values of e , Y_1 and Y_0 are given in the table below.

Bearing Numbers	ISO355 Dimension Series	Abutment and Fillet Dimensions (mm)								Eff. Load Centers (mm)	Constant	Axial Load Factors		Mass (kg)	
		d_a approx.	d_b min.	d_b max.	D_a max.	d_b min.	S_a min.	S_b min.	Cone r_a max.			Cup r_a max.	a		e
HR 32911 J	2BC	64	60	74	73	76	4	3	1	1	14.6	0.31	1.9	1.1	0.282
HR 32011 Xj	3CC	66	62	81	80	86	4	5.5	1.5	1.5	19.7	0.41	1.5	0.81	0.568
HR 33011 J	2CE	66	62	81	80	86	5	6	1.5	1.5	19.2	0.31	1.9	1.1	0.657
HR 33111 J	3CE	66	62	86	82	91	5	7	1.5	1.5	22.4	0.37	1.6	0.88	0.877
HR 30211 J	3DB	67	64	91	89	94	4	4.5	2	1.5	20.9	0.41	1.5	0.81	0.736
HR 32211 J	3DC	67	63	91	87	95	4	5.5	2	1.5	22.7	0.41	1.5	0.81	0.859
HR 33211 J	3DE	67	62	91	86	96	6	8	2	1.5	25.2	0.40	1.5	0.83	1.18
T7 FC055	7FC	73	66	101	86	109	4	10.5	2.5	2.5	39.0	0.87	0.69	0.38	1.58
HR 30311 J	2FB	70	71	110	104	111	4	6.5	2	2	24.6	0.35	1.7	0.96	1.63
HR 30311 Dj	7FB	75	67	110	94	114	4	10.5	2	2	37.0	0.83	0.73	0.40	1.58
HR 31311 J	7FB	75	67	110	94	114	4	10.5	2	2	37.0	0.83	0.73	0.40	1.58
HR 32311 J	2FD	73	67	110	99	111	4	10.5	2	2	29.9	0.35	1.7	0.96	2.39
HR 32311 Cj	5FD	73	65	110	91	112	4	10.5	2	2	35.8	0.55	1.1	0.60	2.47
HR 32912 J	2BC	69	65	79	78	81	4	3	1	1	15.5	0.33	1.8	1.0	0.306
HR 32012 Xj	4CC	71	66	86	85	91	4	5.5	1.5	1.5	20.9	0.43	1.4	0.77	0.608
HR 33012 J	2CE	71	66	86	85	90	5	6	1.5	1.5	20.0	0.33	1.8	1.0	0.713
HR 33112 J	3CE	71	68	91	88	96	5	7	1.5	1.5	23.6	0.40	1.5	0.83	0.91
HR 30212 J	3EB	72	69	101	96	103	4	4.5	2	1.5	22.0	0.41	1.5	0.81	0.930
HR 32212 J	3EC	72	68	101	95	104	4	5.5	2	1.5	24.1	0.41	1.5	0.81	1.18
HR 33212 J	3EE	72	68	101	94	105	6	9	2	1.5	27.6	0.40	1.5	0.82	1.56
T7 FC060	7FC	78	72	111	94	119	4	11	2.5	2.5	41.4	0.82	0.73	0.40	2.03
HR 30312 J	2FB	78	77	118	112	120	4	7.5	2.5	2	26.0	0.35	1.7	0.96	2.03
HR 30312 Dj	7FB	84	74	118	103	125	4	11.5	2.5	2	40.3	0.83	0.73	0.40	1.98
HR 31312 J	7FB	84	74	118	103	125	4	11.5	2.5	2	40.3	0.83	0.73	0.40	1.98
HR 32312 J	2FD	81	74	118	107	120	4	11.5	2.5	2	31.4	0.35	1.7	0.96	2.96
32312 C	—	81	74	116	102	125	4	13.5	2.5	2	39.9	0.58	1.0	0.57	2.86
HR 32913 J	2BC	74	70	84	82	86	4	3	1	1	16.8	0.35	1.7	0.93	0.323
HR 32013 Xj	4CC	76	71	91	90	97	4	5.5	1.5	1.5	22.4	0.46	1.3	0.72	0.646
HR 33013 J	2CE	76	71	91	90	96	5	6	1.5	1.5	21.1	0.35	1.7	0.95	0.76
HR 33113 J	3DE	76	73	101	96	106	6	7.5	1.5	1.5	26.0	0.39	1.5	0.85	1.32
HR 30213 J	3EB	77	78	111	106	113	4	4.5	2	1.5	23.8	0.41	1.5	0.81	1.18
HR 32213 J	3EC	77	75	111	104	115	4	5.5	2	1.5	27.1	0.41	1.5	0.81	1.55
HR 33213 J	3EE	77	74	111	102	115	6	9	2	1.5	29.2	0.39	1.5	0.85	2.04
HR 30313 J	2GB	83	83	128	121	130	4	8	2.5	2	27.9	0.35	1.7	0.96	2.51
HR 30313 Dj	7GB	89	80	128	111	133	4	13	2.5	2	43.2	0.83	0.73	0.40	2.43
HR 31313 J	7GB	89	80	128	111	133	4	13	2.5	2	43.2	0.83	0.73	0.40	2.43
HR 32313 J	2GD	86	80	128	116	130	4	12	2.5	2	34.0	0.35	1.7	0.96	3.6



Single-Row Tapered Roller Bearings

Bore Diameter 70 – 80 mm

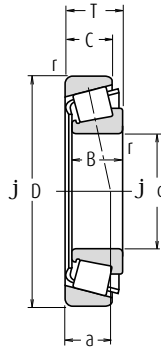

Boundary Dimensions (mm)							Basic Load Ratings (N)		Limiting Speeds (min ⁻¹)		
d	D	T	B	C	Cone	Cup	C _r	C _{0r}	Grease	Oil	
					r	r					
					min.						
70	100	20	20	16	1	1	70 000	113 000	3 200	4 500	
	110	25	25	19	1.5	1.5	104 000	158 000	3 200	4 300	
	110	31	31	25.5	1.5	1.5	127 000	204 000	3 000	4 300	
	120	37	37	29	2	1.5	177 000	262 000	3 000	4 000	
	125	26.25	24	21	2	1.5	132 000	163 000	2 800	4 000	
	125	33.25	31	27	2	1.5	157 000	205 000	2 800	4 000	
	125	41	41	32	2	1.5	209 000	299 000	2 800	4 000	
	140	39	35.5	27	3	3	178 000	235 000	2 400	3 400	
	150	38	35	30	3	2.5	227 000	268 000	2 400	3 400	
	150	38	35	25	3	2.5	192 000	229 000	2 200	3 200	
	150	38	35	25	3	2.5	192 000	229 000	2 200	3 200	
	150	54	51	42	3	2.5	300 000	390 000	2 600	3 400	
	150	54	51	42	3	2.5	280 000	390 000	2 400	3 400	
	75	105	20	20	16	1	1	72 500	120 000	3 200	4 300
115		25	25	19	1.5	1.5	109 000	171 000	3 000	4 000	
115		31	31	25.5	1.5	1.5	133 000	220 000	3 000	4 000	
125		37	37	29	2	2	182 000	275 000	2 800	3 800	
130		27.25	25	22	2	1.5	143 000	182 000	2 800	3 800	
130		33.25	31	27	2	1.5	165 000	219 000	2 800	3 800	
130		41	41	31	2	1.5	215 000	315 000	2 800	3 800	
160		40	37	31	3	2.5	253 000	300 000	2 400	3 200	
160		40	37	26	3	2.5	211 000	251 000	2 200	3 000	
160		40	37	26	3	2.5	211 000	251 000	2 200	3 000	
160		58	55	45	3	2.5	340 000	445 000	2 400	3 200	
160		58	55	43	3	2.5	310 000	420 000	2 200	3 200	
80		110	20	20	16	1	1	75 000	128 000	3 000	4 000
		125	29	29	22	1.5	1.5	140 000	222 000	2 800	3 600
	125	36	36	29.5	1.5	1.5	172 000	282 000	2 800	3 600	
	130	37	37	29	2	1.5	186 000	289 000	2 600	3 600	
	140	28.25	26	22	2.5	2	157 000	195 000	2 600	3 400	
	140	28.25	26	20	2.5	2	147 000	190 000	2 400	3 400	
	140	35.25	33	28	2.5	2	192 000	254 000	2 600	3 400	
	140	46	46	35	2.5	2	256 000	385 000	2 600	3 400	
	170	42.5	39	33	3	2.5	276 000	330 000	2 200	3 000	
	170	42.5	39	27	3	2.5	235 000	283 000	2 000	2 800	
	170	42.5	39	27	3	2.5	235 000	283 000	2 000	2 800	
	170	61.5	58	48	3	2.5	385 000	505 000	2 200	3 000	
	170	61.5	58	48	3	2.5	365 000	530 000	2 200	3 000	

Remark The suffix CA represents medium-angle tapered roller bearings. Since they are designed for specific applications, please consult NSK when using bearings with suffix CA.

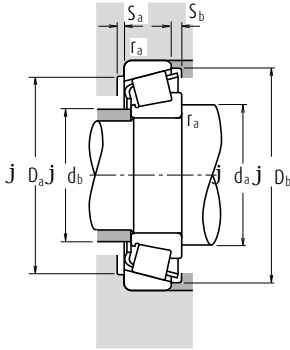

Dynamic Equivalent Load $P = X F_r + Y F_a$

$F_a/F_r \leq e$		$F_a/F_r > e$	
X	Y	X	Y
1	0	0.4	Y_1

Static Equivalent Load

$$P_0 = 0.5 F_r + Y_0 F_a$$

When $F_r > 0.5 F_r + Y_0 F_a$, use $P_0 = F_r$

The values of e , Y_1 and Y_0 are given in the table below.

Bearing Numbers	ISO355 Dimension Series	Abutment and Fillet Dimensions (mm)								Eff. Load Centers (mm)	Constant	Axial Load Factors		Mass (kg)	
		d_a approx.	d_b min.	d_b max.	D_a max.	d_b min.	S_a min.	S_b min.	Cone r_a max.			Cup r_a max.	a		e
HR 32914 J	2BC	79	76	94	93	96	4	4	1	1	17.6	0.32	1.9	1.1	0.494
HR 32014 XJ	4CC	81	77	101	98	105	5	6	1.5	1.5	23.7	0.43	1.4	0.76	0.869
HR 33014 J	2CE	81	78	101	100	105	5	5.5	1.5	1.5	22.2	0.28	2.1	1.2	1.11
HR 33114 J	3DE	82	79	111	104	115	6	8	2	1.5	27.9	0.38	1.6	0.87	1.71
HR 30214 J	3EB	82	81	116	110	118	4	5	2	1.5	25.6	0.42	1.4	0.79	1.3
HR 32214 J	3EC	82	80	116	108	119	4	6	2	1.5	28.6	0.42	1.4	0.79	1.66
HR 33214 J	3EE	82	78	116	107	120	7	9	2	1.5	30.4	0.41	1.5	0.81	2.15
T7 FC070	7FC	88	81	126	106	133	5	12	2.5	2.5	46.4	0.87	0.69	0.38	2.58
HR 30314 J	2GB	88	89	138	132	140	4	8	2.5	2	29.7	0.35	1.7	0.96	3.03
HR 30314 DJ	7GB	94	85	138	118	142	4	13	2.5	2	45.8	0.83	0.73	0.40	2.94
HR 31314 J	7GB	94	85	138	118	142	4	13	2.5	2	45.8	0.83	0.73	0.40	2.94
HR 32314 J	2GD	91	86	138	124	140	4	12	2.5	2	36.1	0.35	1.7	0.96	4.35
HR 32314 CJ	5GD	91	84	138	115	141	4	12	2.5	2	43.3	0.55	1.1	0.60	4.47
HR 32915 J	2BC	84	81	99	98	101	4	4	1	1	18.7	0.33	1.8	0.99	0.53
HR 32015 XJ	4CC	86	82	106	103	110	5	6	1.5	1.5	25.1	0.46	1.3	0.72	0.925
HR 33015 J	2CE	86	83	106	104	110	6	5.5	1.5	1.5	23.0	0.30	2.0	1.1	1.18
HR 33115 J	3DE	87	83	115	109	120	6	8	2	2	29.2	0.40	1.5	0.83	1.8
HR 30215 J	4DB	87	85	121	115	124	4	5	2	1.5	27.0	0.44	1.4	0.76	1.43
HR 32215 J	4DC	87	84	121	113	125	4	6	2	1.5	29.8	0.44	1.4	0.76	1.72
HR 33215 J	3EE	87	83	121	111	125	7	10	2	1.5	31.6	0.43	1.4	0.77	2.25
HR 30315 J	2GB	93	95	148	141	149	4	9	2.5	2	31.8	0.35	1.7	0.96	3.63
HR 30315 DJ	7GB	99	91	148	129	152	6	14	2.5	2	48.8	0.83	0.73	0.40	3.47
HR 31315 J	7GB	99	91	148	129	152	6	14	2.5	2	48.8	0.83	0.73	0.40	3.47
HR 32315 J	2GD	96	91	148	134	149	4	13	2.5	2	38.9	0.35	1.7	0.96	5.31
32315 CA	—	96	90	148	124	153	4	15	2.5	2	47.7	0.58	1.0	0.57	5.3
HR 32916 J	2BC	89	85	104	102	106	4	4	1	1	19.8	0.35	1.7	0.94	0.56
HR 32016 XJ	3CC	91	89	116	112	120	6	7	1.5	1.5	26.9	0.42	1.4	0.78	1.32
HR 33016 J	2CE	91	88	116	112	119	6	6.5	1.5	1.5	25.5	0.28	2.2	1.2	1.66
HR 33116 J	3DE	82	88	121	113	126	6	8	2	1.5	30.4	0.42	1.4	0.79	1.88
HR 30216 J	3EB	95	91	130	124	132	4	6	2	2	28.1	0.42	1.4	0.79	1.68
30216 CA	—	95	92	130	122	133	4	8	2	2	33.8	0.58	1.0	0.57	1.66
HR 32216 J	3EC	95	90	130	122	134	4	7	2	2	30.6	0.42	1.4	0.79	2.13
HR 33216 J	3EE	95	89	130	119	135	7	11	2	2	34.8	0.43	1.4	0.78	2.93
HR 30316 J	2GB	98	102	158	150	159	4	9.5	2.5	2	34.0	0.35	1.7	0.96	4.27
HR 30316 DJ	7GB	104	97	158	136	159	6	15.5	2.5	2	51.8	0.83	0.73	0.40	4.07
HR 31316 J	7GB	104	97	158	136	159	6	15.5	2.5	2	51.8	0.83	0.73	0.40	4.07
HR 32316 J	2GD	101	98	158	143	159	4	13.5	2.5	2	41.4	0.35	1.7	0.96	6.35
HR 32316 CJ	5GD	101	95	158	132	160	4	13.5	2.5	2	49.3	0.55	1.1	0.60	6.59



Single-Row Tapered Roller Bearings

Bore Diameter 85 - 100 mm

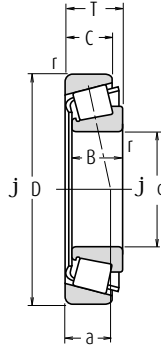

d	Boundary Dimensions (mm)					Cone		Cup		Basic Load Ratings (N)		Limiting Speeds (min ⁻¹)	
	D	T	B	C	r	r	C _r	C _{0r}	Grease	Oil			
85	120	23	23	18	1.5	1.5	93 500	157 000	2 800	3 800			
	130	29	29	22	1.5	1.5	143 000	231 000	2 600	3 600			
	130	36	36	29.5	1.5	1.5	180 000	305 000	2 600	3 600			
	140	41	41	32	2.5	2	230 000	365 000	2 400	3 400			
	150	30.5	28	24	2.5	2	184 000	233 000	2 400	3 200			
	150	30.5	28	22	2.5	2	171 000	226 000	2 200	3 200			
	150	38.5	36	30	2.5	2	210 000	277 000	2 200	3 200			
	150	49	49	37	2.5	2	281 000	415 000	2 400	3 200			
	180	44.5	41	34	4	3	310 000	375 000	2 000	2 800			
	180	44.5	41	28	4	3	261 000	315 000	1 900	2 600			
90	125	23	23	18	1.5	1.5	97 000	167 000	2 600	3 600			
	140	32	32	24	2	1.5	170 000	273 000	2 400	3 200			
	140	39	39	32.5	2	1.5	220 000	360 000	2 400	3 200			
	150	45	45	35	2.5	2	259 000	405 000	2 400	3 200			
	160	32.5	30	26	2.5	2	201 000	256 000	2 200	3 000			
	160	42.5	40	34	2.5	2	256 000	350 000	2 200	3 000			
	190	46.5	43	36	4	3	345 000	425 000	1 900	2 600			
	190	46.5	43	30	4	3	264 000	315 000	1 800	2 400			
	190	46.5	43	30	4	3	264 000	315 000	1 800	2 400			
	190	67.5	64	53	4	3	450 000	590 000	2 000	2 600			
95	130	23	23	18	1.5	1.5	98 000	172 000	2 400	3 400			
	145	32	32	24	2	1.5	173 000	283 000	2 400	3 200			
	145	39	39	32.5	2	1.5	231 000	390 000	2 400	3 200			
	160	46	46	38	3	3	283 000	445 000	2 200	3 000			
	170	34.5	32	27	3	2.5	223 000	286 000	2 200	2 800			
	170	45.5	43	37	3	2.5	289 000	400 000	2 200	2 800			
	200	49.5	45	38	4	3	370 000	455 000	1 900	2 600			
	200	49.5	45	36	4	3	350 000	435 000	1 800	2 400			
	200	49.5	45	32	4	3	310 000	375 000	1 700	2 400			
	200	49.5	45	32	4	3	310 000	375 000	1 700	2 400			
100	200	71.5	67	55	4	3	525 000	710 000	1 900	2 600			
	140	25	25	20	1.5	1.5	117 000	205 000	2 200	3 200			
	145	24	22.5	17.5	3	3	113 000	163 000	2 200	3 000			
	150	32	32	24	2	1.5	176 000	294 000	2 200	3 000			
	150	39	39	32.5	2	1.5	235 000	405 000	2 200	3 000			
	165	52	52	40	2.5	2	315 000	515 000	2 000	2 800			
	180	37	34	29	3	2.5	255 000	330 000	2 000	2 600			
	180	49	46	39	3	2.5	325 000	450 000	2 000	2 600			
	180	63	63	48	3	2.5	410 000	635 000	2 000	2 600			
	215	51.5	47	39	4	3	425 000	525 000	1 700	2 400			
215	56.5	51	35	4	3	385 000	505 000	1 500	2 200				
215	77.5	73	60	4	3	565 000	755 000	1 700	2 400				

Remark The suffix CA represents medium-angle tapered roller bearings. Since they are designed for specific applications, please consult NSK when using bearings with suffix CA.

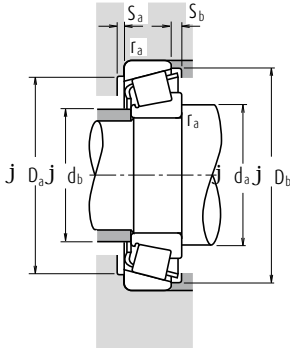

Dynamic Equivalent Load $P = X F_r + Y F_a$

$F_a/F_r \leq e$		$F_a/F_r > e$	
X	Y	X	Y
1	0	0.4	Y_1

Static Equivalent Load

$$P_0 = 0.5 F_r + Y_0 F_a$$

When $F_r > 0.5 F_r + Y_0 F_a$, use $P_0 = F_r$

The values of e , Y_1 and Y_0 are given in the table below.

Bearing Numbers	ISO355 Dimension Series	Abutment and Fillet Dimensions (mm)										Eff. Load Centers (mm)	Constant	Axial Load Factors		Mass (kg)			
		d_a		d_b		D_a		D_b		Cone Cup				a	e		Y_1	Y_0	approx.
		min.	max.	min.	max.	min.	max.	min.	max.	r_a	max.								
HR 32917 J	2BC	96	92	111	111	115	5	5	1.5	1.5	20.9	0.33	1.8	1.0	0.8				
HR 32017 XJ	4CC	96	94	121	116	125	6	7	1.5	1.5	28.2	0.44	1.4	0.75	1.38				
HR 33017 J	2CE	96	94	121	117	125	6	6.5	1.5	1.5	26.5	0.29	2.1	1.1	1.75				
HR 33117 J	3DE	100	94	130	122	135	7	9	2	2	32.7	0.41	1.5	0.81	2.51				
HR 30217 J	3EB	100	97	140	133	141	5	6.5	2	2	30.3	0.42	1.4	0.79	2.12				
30217 CA	—	100	98	140	131	142	5	8.5	2	2	36.2	0.58	1.0	0.57	2.07				
HR 32217 J	3EC	100	96	140	131	142	5	8.5	2	2	33.9	0.42	1.4	0.79	2.64				
HR 33217 J	3EE	100	95	140	129	144	7	12	2	2	37.3	0.42	1.4	0.79	3.57				
HR 30317 J	2GB	106	108	166	157	167	5	10.5	3	2.5	35.8	0.35	1.7	0.96	5.08				
HR 30317 DJ	7GB	113	103	166	144	169	6	16.5	3	2.5	55.4	0.83	0.73	0.40	4.88				
HR 31317 J	7GB	113	103	166	144	169	6	16.5	3	2.5	55.4	0.83	0.73	0.40	4.88				
HR 32317 J	2GD	110	104	166	151	167	5	14.5	3	2.5	43.6	0.35	1.7	0.96	7.31				
HR 32918 J	2BC	101	97	116	116	120	5	5	1.5	1.5	22.0	0.34	1.8	0.96	0.838				
HR 32018 XJ	3CC	102	99	131	124	134	6	8	2	1.5	29.7	0.42	1.4	0.78	1.78				
HR 33018 J	2CE	102	99	131	129	135	7	6.5	2	1.5	27.9	0.27	2.2	1.2	2.21				
HR 33118 J	3DE	105	100	140	132	144	7	10	2	2	35.2	0.40	1.5	0.83	3.14				
HR 30218 J	3FB	105	103	150	141	150	5	6.5	2	2	31.7	0.42	1.4	0.79	2.6				
HR 32218 J	3FC	105	102	150	139	152	5	8.5	2	2	36.2	0.42	1.4	0.79	3.41				
HR 30318 J	2GB	111	114	176	176	176	5	10.5	3	2.5	37.3	0.35	1.7	0.96	5.91				
HR 30318 DJ	7GB	118	110	176	152	179	6	16.5	3	2.5	58.7	0.83	0.73	0.40	5.52				
HR 31318 J	7GB	118	110	176	152	179	6	16.5	3	2.5	58.7	0.83	0.73	0.40	5.52				
HR 32318 J	2GD	115	109	176	158	177	5	14.5	3	2.5	46.5	0.35	1.7	0.96	8.6				
HR 32919 J	2BC	106	102	121	121	125	5	5	1.5	1.5	23.2	0.36	1.7	0.92	0.877				
HR 32019 XJ	4CC	107	104	136	131	140	6	8	2	1.5	31.2	0.44	1.4	0.75	1.88				
HR 33019 J	2CE	107	103	136	133	139	7	6.5	2	1.5	28.6	0.28	2.2	1.2	2.3				
T2 ED095	2ED	113	108	146	141	152	6	8	2.5	2.5	34.5	0.34	1.8	0.97	3.74				
HR 30219 J	3FB	113	110	158	150	159	5	7.5	2.5	2	33.7	0.42	1.4	0.79	3.13				
HR 32219 J	3FC	113	108	158	147	161	5	8.5	2.5	2	39.3	0.42	1.4	0.79	4.22				
HR 30319 J	2GB	116	119	186	172	184	5	11.5	3	2.5	38.6	0.35	1.7	0.96	6.92				
30319 CA	—	116	119	186	168	188	5	13.5	3	2.5	48.6	0.54	1.1	0.61	6.71				
HR 30319 DJ	7GB	123	115	186	158	187	6	17.5	3	2.5	61.9	0.83	0.73	0.40	6.64				
HR 31319 J	7GB	123	115	186	158	187	6	17.5	3	2.5	61.9	0.83	0.73	0.40	6.64				
HR 32319 J	2GD	120	115	186	167	186	5	16.5	3	2.5	48.6	0.35	1.7	0.96	10.4				
HR 32920 J	2CC	111	109	132	132	134	5	5	1.5	1.5	24.2	0.33	1.8	1.0	1.18				
T4 CB100	4CB	118	108	135	135	142	6	6.5	2.5	2.5	30.1	0.47	1.3	0.70	1.18				
HR 32020 XJ	4CC	112	109	141	136	144	6	8	2	1.5	32.5	0.46	1.3	0.72	1.95				
HR 33020 J	2CE	112	107	141	137	143	7	6.5	2	1.5	29.3	0.29	2.1	1.2	2.38				
HR 33120 J	3EE	115	110	155	144	159	8	12	2	2	40.5	0.41	1.5	0.81	4.32				
HR 30220 J	3FB	118	116	168	158	168	5	8	2.5	2	36.1	0.42	1.4	0.79	3.78				
HR 32220 J	3FC	118	115	168	155	171	5	10	2.5	2	41.5	0.42	1.4	0.79	5.05				
HR 33220 J	3FE	118	113	168	152	172	10	15	2.5	2	46.0	0.40	1.5	0.82	6.76				
HR 30320 J	2GB	121	128	201	185	197	5	12.5	3	2.5	41.4	0.35	1.7	0.96	8.41				
HR 31320 J	7GB	136	125	201	169	202	7	21.5	3	2.5	67.7	0.83	0.73	0.40	9.02				
HR 32320 J	2GD	125	125	201	178	200	5	17.5	3	2.5	53.2	0.35	1.7	0.96	12.7				



Single-Row Tapered Roller Bearings

Bore Diameter 105 – 130 mm

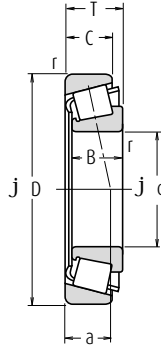

Boundary Dimensions (mm)							Basic Load Ratings (N)		Limiting Speeds (min ⁻¹)	
d	D	T	B	C	Cone	Cup	C _r	C _{0r}	Grease	Oil
					r	r				
					min.					
105	145	25	25	20	1.5	1.5	119 000	212 000	2 200	3 000
	160	35	35	26	2.5	2	204 000	340 000	2 000	2 800
	160	43	43	34	2.5	2	256 000	435 000	2 000	2 800
	190	39	36	30	3	2.5	280 000	365 000	1 900	2 600
	190	53	50	43	3	2.5	360 000	510 000	1 900	2 600
	225	53.5	49	41	4	3	455 000	565 000	1 600	2 200
225	58	53	36	4	3	415 000	540 000	1 500	2 000	
225	81.5	77	63	4	3	670 000	925 000	1 700	2 200	
110	150	25	25	20	1.5	1.5	123 000	224 000	2 200	2 800
	170	38	38	29	2.5	2	236 000	390 000	2 000	2 600
	170	47	47	37	2.5	2	294 000	515 000	2 000	2 600
	180	56	56	43	2.5	2	365 000	610 000	1 900	2 600
	200	41	38	32	3	2.5	315 000	420 000	1 800	2 400
	200	56	53	46	3	2.5	400 000	565 000	1 800	2 400
	240	54.5	50	42	4	3	485 000	595 000	1 500	2 000
	240	63	57	38	4	3	470 000	605 000	1 400	1 900
	240	84.5	80	65	4	3	675 000	910 000	1 500	2 000
	260	68	62	42	4	3	560 000	730 000	1 300	1 800
120	165	29	29	23	1.5	1.5	161 000	291 000	1 900	2 600
	170	27	25	19.5	3	3	153 000	243 000	1 800	2 600
	180	38	38	29	2.5	2	242 000	405 000	1 800	2 400
	180	48	48	38	2.5	2	300 000	540 000	1 800	2 600
	200	62	62	48	2.5	2	460 000	755 000	1 700	2 400
	215	43.5	40	34	3	2.5	335 000	450 000	1 600	2 200
	215	61.5	58	50	3	2.5	440 000	635 000	1 600	2 200
	260	59.5	55	46	4	3	535 000	655 000	1 400	1 900
	260	68	62	42	4	3	560 000	730 000	1 300	1 800
	260	90.5	86	69	4	3	770 000	1 060 000	1 400	1 900
130	180	32	30	26	2	1.5	167 000	281 000	1 800	2 400
	180	32	32	25	2	1.5	200 000	365 000	1 800	2 400
	185	29	27	21	3	3	183 000	296 000	1 700	2 400
	200	45	45	34	2.5	2	320 000	535 000	1 600	2 200
	200	55	55	43	2.5	2	395 000	715 000	1 700	2 200
	230	43.75	40	34	4	3	375 000	505 000	1 500	2 000
	230	67.75	64	54	4	3	530 000	790 000	1 500	2 000
	280	63.75	58	49	5	4	545 000	675 000	1 300	1 800
	280	63.75	58	49	5	4	650 000	820 000	1 300	1 800
	280	72	66	44	5	4	625 000	820 000	1 200	1 700
280	98.75	93	78	5	4	830 000	1 150 000	1 300	1 800	

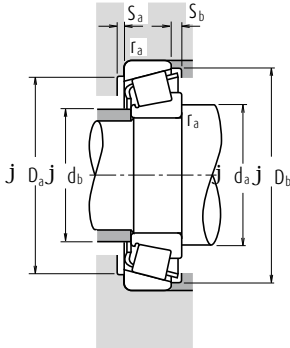

Dynamic Equivalent Load $P = X F_r + Y F_a$

$F_a/F_r \leq e$		$F_a/F_r > e$	
X	Y	X	Y
1	0	0.4	Y_1

Static Equivalent Load

$$P_0 = 0.5 F_r + Y_0 F_a$$

When $F_r > 0.5 F_r + Y_0 F_a$, use $P_0 = F_r$

The values of e , Y_1 and Y_0 are given in the table below.

Bearing Numbers	ISO355 Dimension Series	Abutment and Fillet Dimensions (mm)								Eff. Load Centers (mm)	Constant	Axial Load Factors		Mass (kg)		
		d_a		d_b		S_a		Cone Cup				a	e		Y_1	Y_0
		approx.	min.	max.	min.	max.	min.	max.	r_a max.							
HR 32921 J	2CC	116	114	137	137	140	5	5	1.5	1.5	25.3	0.34	1.8	0.96	1.23	
HR 32021 XJ	4DC	120	115	150	144	154	6	9	2	2	34.3	0.44	1.4	0.74	2.48	
HR 33021 J	2DE	120	115	150	146	153	7	9	2	2	30.9	0.28	2.1	1.2	3.03	
HR 30221 J	3FB	123	123	178	166	177	6	9	2.5	2	38.1	0.42	1.4	0.79	4.51	
HR 32221 J	3FC	123	120	178	162	180	5	10	2.5	2	44.8	0.42	1.4	0.79	6.25	
HR 30321 J	2GB	126	133	211	195	206	6	12.5	3	2.5	43.3	0.35	1.7	0.96	9.52	
HR 31321 J	7GB	141	130	211	177	211	7	22	3	2.5	70.2	0.83	0.73	0.40	10	
HR 32321 J	2GD	130	129	211	186	209	6	18.5	3	2.5	55.2	0.35	1.7	0.96	14.9	
HR 32922 J	2CC	121	119	142	142	145	5	5	1.5	1.5	26.5	0.36	1.7	0.93	1.29	
HR 32022 XJ	4DC	125	121	160	153	163	7	9	2	2	35.9	0.43	1.4	0.77	3.09	
HR 33022 J	2DE	125	121	160	153	161	7	10	2	2	33.7	0.29	2.1	1.2	3.84	
HR 33122 J	3EE	125	121	170	156	174	9	13	2	2	44.1	0.42	1.4	0.79	5.54	
HR 30222 J	3FB	128	129	188	175	187	6	9	2.5	2	40.2	0.42	1.4	0.79	5.28	
HR 32222 J	3FC	128	127	188	171	190	5	10	2.5	2	47.2	0.42	1.4	0.79	7.35	
HR 30322 J	2GB	131	143	226	208	220	6	12.5	3	2.5	45.1	0.35	1.7	0.96	11	
HR 31322 J	7GB	146	136	226	191	224	7	25	3	2.5	74.8	0.83	0.73	0.40	12.3	
HR 32322 J	2GD	135	139	226	201	222	6	19.5	3	2.5	58.6	0.35	1.7	0.96	17.1	
HR 32924 J	2CC	131	129	156	155	160	6	6	1.5	1.5	29.2	0.35	1.7	0.95	1.8	
T4 CB120	4CB	138	129	158	158	164	7	7.5	2.5	2.5	35.0	0.47	1.3	0.70	1.78	
HR 32024 XJ	4DC	135	131	170	162	173	7	9	2	2	39.7	0.46	1.3	0.72	3.27	
HR 33024 J	2DE	135	130	168	161	171	6	10	2	2	36.0	0.31	2.0	1.1	4.2	
HR 33124 J	3FE	135	133	190	173	192	9	14	2	2	47.9	0.40	1.5	0.83	7.67	
HR 30224 J	4FB	138	141	203	190	201	6	9.5	2.5	2	44.4	0.44	1.4	0.76	6.28	
HR 32224 J	4FD	138	137	203	181	204	6	11.5	2.5	2	52.1	0.44	1.4	0.76	9.0	
HR 30324 J	2GB	141	154	246	223	237	6	13.5	3	2.5	50.0	0.35	1.7	0.96	13.9	
HR 31324 J	7GB	156	148	246	206	244	9	26	3	2.5	81.7	0.83	0.73	0.40	15.6	
HR 32324 J	2GD	145	149	246	216	239	6	21.5	3	2.5	62.5	0.35	1.7	0.96	21.8	
32926	—	142	141	171	168	175	6	6	2	1.5	34.7	0.36	1.7	0.92	2.25	
HR 32926 J	2CC	142	140	170	168	173	6	7	2	1.5	31.4	0.34	1.8	0.97	2.46	
T4 CB130	4CB	148	141	171	171	179	8	8	2.5	2.5	37.5	0.47	1.3	0.70	2.32	
HR 32026 XJ	4EC	145	144	190	179	192	8	11	2	2	43.9	0.43	1.4	0.76	5.06	
HR 33026 J	2EE	145	144	188	179	192	8	12	2	2	42.4	0.34	1.8	0.97	6.25	
HR 30226 J	4FB	151	151	216	205	217	7	9.5	3	2.5	45.9	0.44	1.4	0.76	7.25	
HR 32226 J	4FD	151	147	216	196	219	7	13.5	3	2.5	57.0	0.44	1.4	0.76	11.3	
30326	—	157	168	262	239	255	8	14.5	4	3	53.9	0.36	1.7	0.92	16.6	
HR 30326 J	2GB	157	166	262	241	255	8	14.5	4	3	52.8	0.35	1.7	0.96	17.2	
HR 31326 J	7GB	174	159	262	220	261	9	28	4	3	87.1	0.83	0.73	0.40	18.8	
32326	—	162	165	262	233	263	8	20.5	4	3	69.2	0.36	1.7	0.92	26.6	



Single-Row Tapered Roller Bearings

Bore Diameter 140 – 170 mm

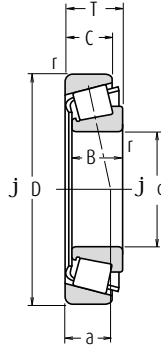

Boundary Dimensions (mm)							Basic Load Ratings (N)		Limiting Speeds (min ⁻¹)		
d	D	T	B	C	Cone	Cup	C _r	C _{0r}	Grease	Oil	
					r	r					
140	190	32	32	25	2	1.5	206 000	390 000	1 700	2 200	
	210	45	45	34	2.5	2	325 000	555 000	1 600	2 200	
	210	56	56	44	2.5	2	410 000	770 000	1 600	2 200	
	250	45.75	42	36	4	3	390 000	515 000	1 400	1 900	
	250	71.75	68	58	4	3	610 000	915 000	1 400	1 900	
	300	67.75	62	53	5	4	740 000	945 000	1 200	1 700	
	300	77	70	47	5	4	695 000	955 000	1 100	1 500	
	300	107.75	102	85	5	4	985 000	1 440 000	1 200	1 600	
	150	210	38	36	31	2.5	2	247 000	440 000	1 500	2 000
		210	38	38	30	2.5	2	281 000	520 000	1 500	2 000
225		48	48	36	3	2.5	375 000	650 000	1 400	2 000	
225		59	59	46	3	2.5	435 000	805 000	1 400	2 000	
270		49	45	38	4	3	485 000	665 000	1 300	1 800	
270		77	73	60	4	3	705 000	1 080 000	1 300	1 800	
320		72	65	55	5	4	690 000	860 000	1 100	1 500	
320		72	65	55	5	4	825 000	1 060 000	1 100	1 600	
320		82	75	50	5	4	790 000	1 100 000	1 000	1 400	
320		114	108	90	5	4	1 120 000	1 700 000	1 100	1 500	
160	220	38	38	30	2.5	2	296 000	570 000	1 400	1 900	
	240	51	51	38	3	2.5	425 000	750 000	1 300	1 800	
	290	52	48	40	4	3	530 000	730 000	1 200	1 600	
	290	84	80	67	4	3	795 000	1 220 000	1 200	1 600	
	340	75	68	58	5	4	765 000	960 000	1 000	1 400	
	340	75	68	58	5	4	870 000	1 110 000	1 100	1 400	
	340	75	68	48	5	4	675 000	875 000	950	1 300	
	340	121	114	95	5	4	1 210 000	1 770 000	1 000	1 400	
	170	230	38	36	31	2.5	2.5	258 000	485 000	1 300	1 800
		230	38	38	30	2.5	2	294 000	560 000	1 400	1 800
260		57	57	43	3	2.5	505 000	890 000	1 200	1 700	
310		57	52	43	5	4	630 000	885 000	1 100	1 500	
310		91	86	71	5	4	930 000	1 450 000	1 100	1 500	
360		80	72	62	5	4	845 000	1 080 000	950	1 300	
360		80	72	62	5	4	960 000	1 230 000	1 000	1 300	
360		80	72	50	5	4	760 000	1 040 000	900	1 200	
360		127	120	100	5	4	1 370 000	2 050 000	1 000	1 300	

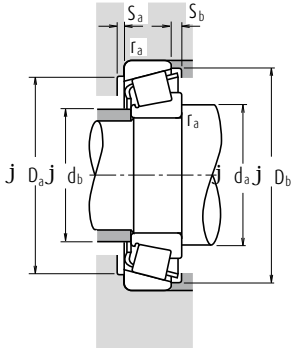

Dynamic Equivalent Load $P = XF_r + YF_a$

$F_a/F_r \leq e$		$F_a/F_r > e$	
X	Y	X	Y
1	0	0.4	Y_1

Static Equivalent Load

$$P_0 = 0.5F_r + Y_0F_a$$

When $F_r > 0.5F_r + Y_0F_a$, use $P_0 = F_r$

The values of e , Y_1 and Y_0 are given in the table below.

Bearing Numbers	ISO355 Dimension Series	Abutment and Fillet Dimensions (mm)										Eff. Load Centers (mm)	Constant	Axial Load Factors		Mass (kg)			
		d_a		d_b		D_a		D_b		Cone Cup				a	e		Y_1	Y_0	approx.
		min.	max.	min.	max.	min.	max.	min.	max.	S_a	S_b								
HR 32928 J	2CC	152	150	180	178	184	184	6	7	2	1.5	33.6	0.36	1.7	0.92	2.64			
HR 32028 XJ	4DC	155	152	200	189	202	8	11	2	2	46.6	0.46	1.3	0.72	5.32				
HR 33028 J	2DE	155	153	198	189	202	7	12	2	2	45.5	0.36	1.7	0.92	6.74				
HR 30228 J	4FB	161	164	236	221	234	7	9.5	3	2.5	48.9	0.44	1.4	0.76	8.74				
HR 32228 J	4FD	161	159	236	213	238	9	13.5	3	2.5	60.5	0.44	1.4	0.76	14.3				
HR 30328 J	2GB	167	177	282	256	273	9	14.5	4	3	55.7	0.35	1.7	0.96	21.1				
HR 31328 J	7GB	184	174	282	236	280	9	30	4	3	92.9	0.83	0.73	0.40	28.5				
32328	—	172	177	282	246	281	9	22.5	4	3	76.4	0.37	1.6	0.88	33.9				
32930	—	165	162	200	195	201	7	7	2	2	36.7	0.33	1.8	1.0	3.8				
HR 32930 J	2DC	165	163	198	196	202	7	8	2	2	36.5	0.33	1.8	1.0	4.05				
HR 32030 XJ	4EC	168	164	213	202	216	8	12	2.5	2	49.8	0.46	1.3	0.72	6.6				
HR 33030 J	2EE	168	165	213	203	217	8	13	2.5	2	48.7	0.36	1.7	0.90	8.07				
HR 30230 J	2GB	171	175	256	236	250	7	11	3	2.5	51.3	0.44	1.4	0.76	11.2				
HR 32230 J	4GD	171	171	256	228	254	8	17	3	2.5	64.7	0.44	1.4	0.76	17.8				
30330	—	177	193	302	275	292	8	17	4	3	61.4	0.36	1.7	0.92	24.2				
HR 30330 J	2GB	177	190	302	276	292	8	17	4	3	60.0	0.35	1.7	0.96	25				
HR 31330 J	7GB	194	187	302	253	300	9	32	4	3	99.3	0.83	0.73	0.40	28.5				
32330	—	182	191	302	262	297	8	24	4	3	81.5	0.37	1.6	0.88	41.4				
HR 32932 J	2DC	175	173	208	206	212	7	8	2	2	38.7	0.35	1.7	0.95	4.32				
HR 32032 XJ	4EC	178	175	228	216	231	8	13	2.5	2	53.0	0.46	1.3	0.72	7.93				
HR 30232 J	4GB	181	189	276	253	269	8	12	3	2.5	55.0	0.44	1.4	0.76	13.7				
HR 32232 J	4GD	181	184	276	243	274	10	17	3	2.5	70.5	0.44	1.4	0.76	22.7				
30332	—	187	205	322	293	311	10	17	4	3	64.6	0.36	1.7	0.92	28.4				
HR 30332 J	2GB	187	201	322	293	310	10	17	4	3	62.9	0.35	1.7	0.96	29.2				
30332 D	—	196	198	322	270	313	9	27	4	3	99.4	0.81	0.74	0.41	27.5				
32332	—	192	202	322	281	319	10	26	4	3	87.1	0.37	1.6	0.88	48.3				
32934	—	185	183	220	216	223	7	7	2	2	41.6	0.36	1.7	0.90	4.3				
HR 32934 J	3DC	185	180	218	215	222	7	8	2	2	41.7	0.38	1.6	0.86	4.44				
HR 32034 XJ	4EC	188	187	248	232	249	10	14	2.5	2	56.6	0.44	1.4	0.74	10.6				
HR 30234 J	4GB	197	202	292	273	288	8	14	4	3	59.4	0.44	1.4	0.76	17.1				
HR 32234 J	4GD	197	197	292	262	294	10	20	4	3	76.4	0.44	1.4	0.76	28				
30334	—	197	221	342	312	332	10	18	4	3	70.1	0.37	1.6	0.90	33.5				
HR 30334 J	2GB	197	214	342	310	329	10	18	4	3	67.3	0.35	1.7	0.96	34.5				
30334 D	—	206	215	342	288	332	10	30	4	3	107.3	0.81	0.74	0.41	33.4				
32334	—	202	213	342	297	337	10	27	4	3	91.3	0.37	1.6	0.88	57				



Single-Row Tapered Roller Bearings

Bore Diameter 180 – 240 mm

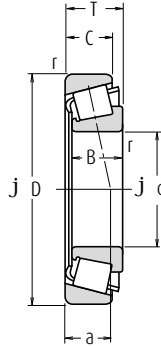

d	Boundary Dimensions (mm)				Cone		Cup		Basic Load Ratings (N)		Limiting Speeds (min ⁻¹)	
	D	T	B	C	r	r _{min.}	C _r	C _{0r}	Grease	Oil		
180	250	45	45	34	2,5	2	350 000	685 000	1 300	1 700		
	280	64	64	48	3	2,5	640 000	1 130 000	1 200	1 600		
	320	57	52	43	5	4	650 000	930 000	1 100	1 400		
	320	91	86	71	5	4	960 000	1 540 000	1 100	1 400		
	380	83	75	64	5	4	935 000	1 230 000	900	1 300		
	380	83	75	53	5	4	820 000	1 120 000	850	1 200		
190	380	134	126	106	5	4	1 520 000	2 290 000	950	1 300		
	260	45	45	34	2,5	2	365 000	715 000	1 200	1 600		
	290	64	64	48	3	2,5	650 000	1 170 000	1 100	1 500		
	340	60	55	46	5	4	715 000	1 020 000	1 000	1 300		
	340	97	92	75	5	4	1 110 000	1 770 000	1 000	1 400		
	400	86	78	65	6	5	1 010 000	1 340 000	850	1 200		
200	400	140	132	109	6	5	1 660 000	2 580 000	850	1 200		
	280	51	48	41	3	2,5	410 000	780 000	1 100	1 500		
	280	51	51	39	3	2,5	480 000	935 000	1 100	1 500		
	310	70	70	53	3	2,5	760 000	1 370 000	1 000	1 400		
	360	64	58	48	5	4	795 000	1 120 000	950	1 300		
	360	104	98	82	5	4	1 210 000	1 920 000	950	1 300		
220	420	89	80	67	6	5	1 030 000	1 390 000	850	1 200		
	420	89	80	56	6	5	965 000	1 330 000	750	1 000		
	420	146	138	115	6	5	1 820 000	2 870 000	800	1 100		
	300	51	51	39	3	2,5	490 000	990 000	1 000	1 400		
	340	76	76	57	4	3	885 000	1 610 000	950	1 300		
	400	72	65	54	5	4	810 000	1 150 000	850	1 100		
240	400	114	108	90	5	4	1 340 000	2 210 000	850	1 100		
	460	97	88	73	6	5	1 430 000	1 990 000	750	1 000		
	460	154	145	122	6	5	2 020 000	3 200 000	750	1 000		
	320	51	51	39	3	2,5	500 000	1 040 000	950	1 300		
	360	76	76	57	4	3	920 000	1 730 000	850	1 200		
	440	79	72	60	5	4	990 000	1 400 000	750	1 000		
500	440	127	120	100	5	4	1 630 000	2 730 000	750	1 000		
	500	105	95	80	6	5	1 660 000	2 340 000	670	950		
	500	165	155	132	6	5	2 520 000	4 100 000	670	900		

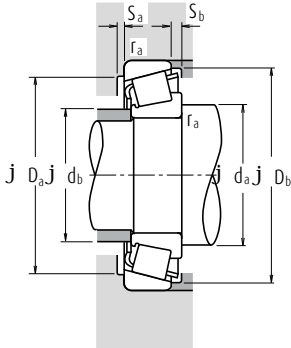

Dynamic Equivalent Load $P = X F_r + Y F_a$

$F_a/F_r \leq e$		$F_a/F_r > e$	
X	Y	X	Y
1	0	0.4	Y_1

Static Equivalent Load

$$P_0 = 0.5 F_r + Y_0 F_a$$

When $F_r > 0.5 F_r + Y_0 F_a$, use $P_0 = F_r$

The values of e , Y_1 and Y_0 are given in the table below.

Bearing Numbers	ISO355 Dimension Series	Abutment and Fillet Dimensions (mm)								Eff. Load Centers (mm)	Constant	Axial Load Factors		Mass (kg)		
		d_a		d_b		S_a		Cone Cup				a	e		Y_1	Y_0
		min.	max.	min.	max.	min.	max.	max.	max.							
HR 32936 J	4DC	195	192	240	227	241	8	11	2	2	53.9	0.48	1.3	0.69	6.56	
HR 32036 XJ	3FD	198	199	268	248	267	10	16	2.5	2	60.4	0.42	1.4	0.78	14.3	
HR 30236 J	4GB	207	210	302	281	297	9	14	4	3	61.8	0.45	1.3	0.73	17.8	
HR 32236 J	4GD	207	205	302	270	303	10	20	4	3	78.9	0.45	1.3	0.73	29.8	
30336	—	207	233	362	324	345	10	19	4	3	72.5	0.36	1.7	0.92	39.3	
30336 D	—	216	229	362	304	352	10	30	4	3	113.1	0.81	0.74	0.41	38.5	
32336	—	212	225	362	310	353	10	28	4	3	96.6	0.37	1.6	0.88	66.8	
HR 32938 J	4DC	205	201	250	237	251	8	11	2	2	55.3	0.48	1.3	0.69	6.83	
HR 32038 XJ	4FD	208	209	278	258	279	10	16	2.5	2	63.4	0.44	1.4	0.75	14.9	
HR 30238 J	4GB	217	223	322	302	318	9	14	4	3	65.6	0.44	1.4	0.76	21.4	
HR 32238 J	4GD	217	216	322	290	323	10	22	4	3	80.5	0.44	1.4	0.76	35.2	
30338	—	223	248	378	346	366	11	21	5	4	76.1	0.36	1.7	0.92	46	
32338	—	229	243	378	332	375	11	31	5	4	102.7	0.37	1.6	0.88	78.9	
32940	—	218	217	268	256	269	9	10	2.5	2	53.4	0.37	1.6	0.88	9.26	
HR 32940 J	3EC	218	216	268	258	271	9	12	2.5	2	54.2	0.39	1.5	0.84	9.65	
HR 32040 XJ	4FD	218	221	298	277	297	11	17	2.5	2	67.4	0.43	1.4	0.77	18.9	
HR 30240 J	4GB	227	236	342	318	336	10	16	4	3	69.1	0.44	1.4	0.76	25.5	
HR 32240 J	3GD	227	230	342	305	340	11	22	4	3	85.1	0.41	1.5	0.81	42.6	
30340	—	233	253	398	346	368	11	22	5	4	81.4	0.37	1.6	0.88	52.3	
30340 D	—	244	253	398	336	385	11	33	5	4	122.9	0.81	0.74	0.41	49.6	
32340	—	239	253	398	346	392	11	31	5	4	106.7	0.37	1.6	0.88	90.9	
HR 32944 J	3EC	238	235	288	278	293	9	12	2.5	2	59.2	0.43	1.4	0.78	10.3	
HR 32044 XJ	4FD	241	244	326	303	326	12	19	3	2.5	73.6	0.43	1.4	0.77	24.4	
30244	—	247	267	382	350	367	11	18	4	3	74.7	0.40	1.5	0.82	33.6	
32244	—	247	260	382	340	377	12	24	4	3	93.0	0.40	1.5	0.82	57.4	
30344	—	253	283	438	390	414	12	24	5	4	85.4	0.36	1.7	0.92	72.4	
32344	—	259	274	438	372	421	12	32	5	4	114.9	0.37	1.6	0.88	114	
HR 32948 J	4EC	258	255	308	297	314	9	12	2.5	2	65.1	0.46	1.3	0.72	11.1	
HR 32048 XJ	4FD	261	262	346	321	346	12	19	3	2.5	79.1	0.46	1.3	0.72	26.2	
30248	—	267	288	422	384	408	11	19	4	3	85.1	0.44	1.4	0.74	45.2	
32248	—	267	285	422	374	416	12	27	4	3	102.5	0.40	1.5	0.82	78	
30348	—	273	308	478	422	447	12	25	5	4	92.8	0.36	1.7	0.92	92.6	
32348	—	279	301	478	410	464	12	33	5	4	123.2	0.37	1.6	0.88	145	



Single-Row Tapered Roller Bearings

Bore Diameter 260 – 440 mm

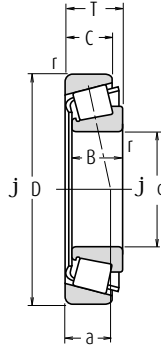

d	Boundary Dimensions (mm)				Cone		Cup		Basic Load Ratings (N)		Limiting Speeds (min ⁻¹)	
	D	T	B	C	r min.	r	C _r	C _{0r}	Grease	Oil		
260	360	63.5	63.5	48	3	2.5	730 000	1 450 000	850	1 100		
	400	87	87	65	5	4	1 160 000	2 160 000	800	1 100		
	480	89	80	67	6	5	1 190 000	1 700 000	670	900		
	480	137	130	106	6	5	1 900 000	3 300 000	670	950		
	540	113	102	85	6	6	1 870 000	2 640 000	630	850		
280	540	176	165	136	6	6	2 910 000	4 800 000	630	850		
	380	63.5	63.5	48	3	2.5	765 000	1 580 000	800	1 100		
	420	87	87	65	5	4	1 180 000	2 240 000	710	1 000		
	500	89	80	67	6	5	1 240 000	1 900 000	630	850		
	500	137	130	106	6	5	1 950 000	3 450 000	630	850		
300	580	187	175	145	6	6	3 300 000	5 400 000	560	800		
	420	76	72	62	4	3	895 000	1 820 000	710	950		
	420	76	76	57	4	3	1 010 000	2 100 000	710	950		
	460	100	100	74	5	4	1 440 000	2 700 000	670	900		
	540	96	85	71	6	5	1 440 000	2 100 000	600	800		
320	540	149	140	115	6	5	2 220 000	3 700 000	600	800		
	440	76	72	63	4	3	900 000	1 880 000	970	900		
	440	76	76	57	4	3	1 040 000	2 220 000	670	900		
	480	100	100	74	5	4	1 510 000	2 910 000	630	850		
	580	104	92	75	6	5	1 640 000	2 420 000	530	750		
340	580	159	150	125	6	5	2 860 000	5 050 000	530	750		
	670	210	200	170	7.5	7.5	4 200 000	7 100 000	480	670		
	460	76	72	63	4	3	910 000	1 940 000	630	850		
	460	76	76	57	4	3	1 050 000	2 220 000	630	850		
	520	112	106	92	6	5	1 650 000	3 400 000	560	750		
360	480	76	72	62	4	3	945 000	2 100 000	600	800		
	480	76	76	57	4	3	1 080 000	2 340 000	560	800		
	540	112	106	92	6	5	1 680 000	3 500 000	530	750		
380	520	87	82	71	5	4	1 210 000	2 550 000	560	750		
400	540	87	82	71	5	4	1 250 000	2 700 000	530	710		
	600	125	118	100	6	5	1 960 000	4 050 000	480	670		
420	560	87	82	72	5	4	1 300 000	2 810 000	500	670		
	620	125	118	100	6	5	2 000 000	4 200 000	450	630		
440	650	130	122	104	6	6	2 230 000	4 600 000	430	600		

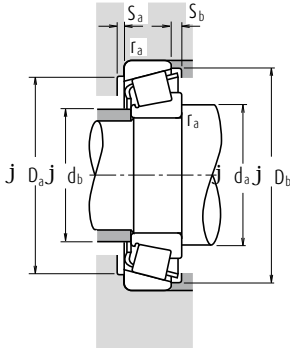

Dynamic Equivalent Load $P=XF_r+YF_a$

$F_a/F_r \leq e$		$F_a/F_r > e$	
X	Y	X	Y
1	0	0.4	Y_1

Static Equivalent Load

$$P_0=0.5F_r+Y_0F_a$$

When $F_r > 0.5F_r+Y_0F_a$, use $P_0=F_r$

The values of e , Y_1 and Y_0 are given in the table below.

Bearing Numbers	ISO355 Dimension Series	Abutment and Fillet Dimensions (mm)										Eff. Load Centers (mm)	Constant	Axial Load Factors		Mass (kg)		
		d_a		d_b		D_a		D_b		Cone Cup				a	e		Y_1	Y_0
		min.	max.	min.	max.	min.	max.	min.	max.	r_a	max.							
HR 32952 J	3EC	278	278	348	333	347	11	15.5	2.5	2	69.8	0.41	1.5	0.81	18.6			
HR 32052 XJ	4FC	287	287	382	357	383	14	22	4	3	86.3	0.43	1.4	0.76	38.5			
30252	—	293	316	458	421	447	12	22	5	4	94.6	0.44	1.4	0.74	60.7			
32252	—	293	305	458	394	446	14	31	5	4	116.0	0.45	1.3	0.73	103			
30352	—	293	336	512	460	487	16	28	5	5	101.6	0.36	1.7	0.92	114			
32352	—	293	328	512	441	495	13	40	5	5	130.5	0.37	1.6	0.88	188			
HR 32956 J	4EC	298	297	368	352	368	12	15.5	2.5	2	75.3	0.43	1.4	0.76	20			
HR 32056 XJ	4FC	307	305	402	374	402	14	22	4	3	91.6	0.46	1.3	0.72	40.6			
30256	—	313	339	478	436	462	12	22	5	4	98.5	0.44	1.4	0.74	66.3			
32256	—	313	325	478	412	467	14	31	5	4	123.1	0.47	1.3	0.70	109			
32356	—	319	353	552	475	532	14	42	5	5	139.6	0.37	1.6	0.89	224			
32960	—	321	326	406	386	405	13	14	3	2.5	79.3	0.37	1.6	0.88	30.5			
HR 32960 J	3FD	321	324	406	387	405	13	19	3	2.5	79.9	0.39	1.5	0.84	31.4			
HR 32060 XJ	4GD	327	330	442	408	439	15	26	4	3	98.4	0.43	1.4	0.76	56.6			
30260	—	333	355	518	470	499	14	25	5	4	105.1	0.44	1.4	0.74	80.6			
32260	—	333	352	518	458	514	15	34	5	4	131.7	0.46	1.3	0.72	132			
32964	—	341	345	426	404	425	13	13	3	2.5	84.3	0.39	1.5	0.84	32			
HR 32964 J	3FD	341	344	426	406	426	13	19	3	2.5	85.0	0.42	1.4	0.79	33.3			
HR 32064 XJ	4GD	347	350	462	430	461	15	26	4	3	104.5	0.46	1.3	0.72	60			
30264	—	353	381	558	503	533	14	29	5	4	113.7	0.44	1.4	0.74	99.3			
32264	—	353	383	558	487	550	15	34	5	4	141.7	0.46	1.3	0.72	175			
32364	—	383	412	634	547	616	14	42	6	6	157.5	0.37	1.6	0.88	343			
32968	—	361	364	446	426	446	13	13	3	2.5	89.2	0.41	1.5	0.80	33.6			
HR 32968 J	4FD	361	362	446	427	446	13	19	3	2.5	91.0	0.44	1.4	0.75	34.3			
32068	—	373	386	498	464	496	3.5	22	5	4	104.5	0.37	1.6	0.89	83.7			
32972	—	381	386	466	445	465	14	14	3	2.5	91.4	0.40	1.5	0.82	35.8			
HR 32972 J	4FD	381	381	466	445	466	13	19	3	2.5	96.8	0.46	1.3	0.72	36.1			
32072	—	393	402	518	480	514	5.5	22	5	4	108.6	0.38	1.6	0.86	86.5			
32976	—	407	406	502	478	501	16	16	4	3	95.2	0.39	1.6	0.86	49.5			
32980	—	427	428	522	499	524	16	16	4	3	100.8	0.40	1.5	0.82	52.7			
32080	—	433	443	578	533	565	5	25	5	4	115.3	0.36	1.7	0.92	116			
32984	—	447	448	542	521	544	3.5	15	4	3	106.1	0.41	1.5	0.81	54.8			
32084	—	453	463	598	552	586	6.5	25	5	4	120.0	0.37	1.6	0.88	121			
32088	—	473	487	622	582	616	5	26	5	5	126.3	0.36	1.7	0.92	136			



Single-Row Tapered Roller Bearings (Inch Design)

Bore Diameter 12.000 - 22.225 mm

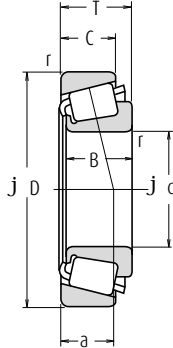

Boundary Dimensions (mm)							Basic Load Ratings (N)		Limiting Speeds (min ⁻¹)	
d	D	T	B	C	Cone	Cup	C _r	C _{0r}	Grease	Oil
					r min.	r min.				
12.000	31.991	10.008	10.785	7.938	0.8	1.3	10 300	8 900	13 000	18 000
12.700	34.988	10.998	10.988	8.730	1.3	1.3	11 700	10 900	12 000	16 000
15.000	34.988	10.998	10.988	8.730	0.8	1.3	11 700	10 900	12 000	16 000
15.875	34.988	10.998	10.998	8.712	1.3	1.3	13 800	13 400	11 000	15 000
	39.992	12.014	11.153	9.525	1.3	1.3	14 900	15 700	9 500	13 000
	41.275	14.288	14.681	11.112	1.3	2.0	21 300	19 900	10 000	13 000
	42.862	14.288	14.288	9.525	1.5	1.5	17 300	17 200	8 500	12 000
	42.862	16.670	16.670	13.495	1.5	1.5	26 900	26 300	9 500	13 000
	44.450	15.494	14.381	11.430	1.5	1.5	23 800	23 900	8 500	11 000
	49.225	19.845	21.539	14.288	0.8	1.3	37 500	37 000	8 500	11 000
16.000	47.000	21.000	21.000	16.000	1.0	2.0	35 000	36 500	9 000	12 000
16.993	39.992	12.014	11.153	9.525	0.8	1.3	14 900	15 700	9 500	13 000
17.455	36.525	11.112	11.112	7.938	1.5	1.5	11 600	11 000	10 000	14 000
17.462	39.878	13.843	14.605	10.668	1.3	1.3	22 500	22 500	10 000	13 000
	47.000	14.381	14.381	11.112	0.8	1.3	23 800	23 900	8 500	11 000
19.050	39.992	12.014	11.153	9.525	1.0	1.3	14 900	15 700	9 500	13 000
	45.237	15.494	16.637	12.065	1.3	1.3	28 500	28 900	9 000	12 000
	47.000	14.381	14.381	11.112	1.3	1.3	23 800	23 900	8 500	11 000
	49.225	18.034	19.050	14.288	1.3	1.3	37 500	37 000	8 500	11 000
	49.225	19.845	21.539	14.288	1.2	1.3	37 500	37 000	8 500	11 000
	49.225	21.209	19.050	17.462	1.3	1.5	37 500	37 000	8 500	11 000
	49.225	23.020	21.539	17.462	C1.5	3.5	37 500	37 000	8 500	11 000
	53.975	22.225	21.839	15.875	1.5	2.3	40 500	39 500	7 500	10 000
19.990	47.000	14.381	14.381	11.112	1.5	1.3	23 800	23 900	8 500	11 000
20.000	51.994	15.011	14.260	12.700	1.5	1.3	26 000	27 900	7 500	10 000
20.625	49.225	23.020	21.539	17.462	1.5	1.5	37 500	37 000	8 500	11 000
20.638	49.225	19.845	19.845	15.875	1.5	1.5	36 000	37 000	8 000	11 000
21.430	50.005	17.526	18.288	13.970	1.3	1.3	38 500	40 000	8 000	11 000
22.000	45.237	15.494	16.637	12.065	1.3	1.3	29 200	33 500	8 500	11 000
	45.975	15.494	16.637	12.065	1.3	1.3	29 200	33 500	8 500	11 000
22.225	50.005	13.495	14.260	9.525	1.3	1.0	26 000	27 900	7 500	10 000
	50.005	17.526	18.288	13.970	1.3	1.3	38 500	40 000	8 000	11 000
	52.388	19.368	20.168	14.288	1.5	1.5	40 500	43 000	7 500	10 000
	53.975	19.368	20.168	14.288	1.5	1.5	40 500	43 000	7 500	10 000
	56.896	19.368	19.837	15.875	1.3	1.3	38 000	40 500	7 100	9 500
	57.150	22.225	22.225	17.462	0.8	1.5	48 000	50 000	7 100	9 500

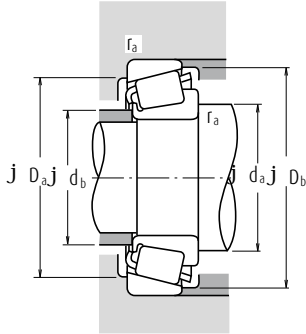

Dynamic Equivalent Load $P = X F_r + Y F_a$

$F_a/F_r \leq e$		$F_a/F_r > e$	
X	Y	X	Y
1	0	0.4	Y_1

Static Equivalent Load

$$P_0 = 0.5 F_r + Y_0 F_a$$

When $F_r > 0.5 F_r + Y_0 F_a$, use $P_0 = F_r$

The values of e , Y_1 and Y_0 are given in the table below.

Bearing Numbers		Abutment and Fillet Dimensions (mm)						Eff. Load Centers (mm)	Constant	Axial Load Factors		Mass (kg)	
CONE	CUP	d_a	d_b	D_a	D_b	Cone r_a max.	Cup			e	Y_1	Y_0	CONE
* A 2047	A 2126	16.5	15.5	26	29	0.8	1.3	6.8	0.41	1.5	0.81	0.023	0.017
A 4050	A 4138	18.5	17	29	32	1.3	1.3	8.2	0.45	1.3	0.73	0.033	0.022
* A 4059	A 4138	19.5	19	29	32	0.8	1.3	8.2	0.45	1.3	0.73	0.029	0.022
L 21549	L 21511	21.5	19.5	29	32.5	1.3	1.3	7.7	0.32	1.9	1.0	0.031	0.018
A 6062	A 6157	22	20.5	34	37	1.3	1.3	10.3	0.53	1.1	0.63	0.044	0.031
03062	03162	21.5	20	34	37.5	1.3	2	9.1	0.31	1.9	1.1	0.061	0.035
11590	11520	24.5	22.5	34.5	39.5	1.5	1.5	13.0	0.70	0.85	0.47	0.061	0.040
17580	17520	23	21	36.5	39	1.5	1.5	10.6	0.33	1.8	1.0	0.075	0.048
05062	05175	23.5	21	38	42	1.5	1.5	11.2	0.36	1.7	0.93	0.081	0.039
09062	09195	22	21.5	42	44.5	0.8	1.3	10.7	0.27	2.3	1.2	0.139	0.065
* HM 81649	** HM 81610	27.5	23	37.5	43	1	2	14.9	0.55	1.1	0.60	0.115	0.082
A 6067	A 6157	22	21	34	37	0.8	1.3	10.3	0.53	1.1	0.63	0.042	0.031
A 5069	A 5144	23.5	21.5	30	33.5	1.5	1.5	8.9	0.49	1.2	0.68	0.030	0.020
† LM 11749	† LM 11710	23	21.5	34	37	1.3	1.3	8.7	0.29	2.1	1.2	0.055	0.028
05068	05185	23	22.5	40.5	42.5	0.8	1.3	10.1	0.36	1.7	0.93	0.082	0.047
A 6075	A 6157	24	23	34	37	1	1.3	10.3	0.53	1.1	0.63	0.037	0.031
† LM 11949	† LM 11910	25	23.5	39.5	41.5	1.3	1.3	9.5	0.30	2.0	1.1	0.081	0.044
05075	05185	25	23.5	40.5	42.5	1.3	1.3	10.1	0.36	1.7	0.93	0.077	0.047
09067	09195	25.5	24	42	44.5	1.3	1.3	10.7	0.27	2.3	1.2	0.115	0.065
09078	09195	25.5	24	42	44.5	1.2	1.3	10.7	0.27	2.3	1.2	0.124	0.065
09067	09196	25.5	24	41.5	44.5	1.3	1.5	13.8	0.27	2.3	1.2	0.115	0.085
09074	09194	26	24	39	44.5	1.5	3.5	13.8	0.27	2.3	1.2	0.124	0.082
21075	21212	31.5	26	43	50	1.5	2.3	16.3	0.59	1.0	0.56	0.156	0.097
05079	05185	26.5	24	40.5	42.5	1.5	1.3	10.1	0.36	1.7	0.93	0.073	0.047
07079	07204	27.5	27	45	48	1.5	1.3	12.1	0.40	1.5	0.82	0.105	0.061
09081	09196	27.5	25.5	41.5	44.5	1.5	1.5	13.8	0.27	2.3	1.2	0.115	0.085
12580	12520	28.5	26	42.5	45.5	1.5	1.5	12.9	0.32	1.9	1.0	0.114	0.067
† M 12649	† M 12610	27.5	25.5	44	46	1.3	1.3	10.9	0.28	2.2	1.2	0.115	0.059
* † LM 12749	† LM 12710	27.5	26	39.5	42.5	1.3	1.3	10.0	0.31	2.0	1.1	0.078	0.038
* † LM 12749	† LM 12711	27.5	26	40	42.5	1.3	1.3	10.0	0.31	2.0	1.1	0.078	0.043
07087	07196	28.5	27	44.5	47	1.3	1	10.6	0.40	1.5	0.82	0.097	0.035
† M 12648	† M 12610	28.5	26.5	44	46	1.3	1.3	10.9	0.28	2.2	1.2	0.111	0.059
1380	1328	29.5	27	45	48.5	1.5	1.5	11.3	0.29	2.1	1.1	0.137	0.067
1380	1329	29.5	27	46	49	1.5	1.5	11.3	0.29	2.1	1.1	0.137	0.082
1755	1729	29	27.5	49	51	1.3	1.3	12.2	0.31	2.0	1.1	0.152	0.102
1280	1220	29.5	29	49	52	0.8	1.5	15.1	0.35	1.7	0.95	0.183	0.106

- Notes**
- * The maximum bore diameter is listed and its tolerance is negative (See Table 7.4.1 on Page A136).
 - ** The maximum outside diameter is listed and its tolerance is negative (See Table 7.4.2 on Pages A136 and A137).
 - † The tolerances for the bore diameter and overall bearing width differ from the standard (See Table 5 on Page B203).
 - * † The tolerance for the bore diameter is 0 to -20 μm, and for overall bearing width is +356 to 0 μm.

Single-Row Tapered Roller Bearings (Inch Design)

Bore Diameter 22.606 – 28.575 mm

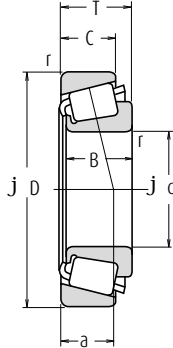

d	Boundary Dimensions (mm)					Cone		Basic Load Ratings (N)		Limiting Speeds (min ⁻¹)	
	D	T	B	C	r min.	C _r	C _{0r}	Grease	Oil		
22.606	47.000	15.500	15.500	12.000	1.5	1.0	26 300	30 000	8 000	11 000	
23.812	50.292	14.224	14.732	10.668	1.5	1.3	27 600	32 000	7 100	10 000	
56.896	19.368	19.837	15.875	0.8	1.3	38 000	40 500	7 100	9 500		
24.000	55.000	25.000	25.000	21.000	2.0	2.0	49 500	55 000	7 100	9 500	
24.981	51.994	15.011	14.260	12.700	1.5	1.3	26 000	27 900	7 500	10 000	
52.001	15.011	14.260	12.700	1.5	2.0	26 000	27 900	7 500	10 000		
62.000	16.002	16.566	14.288	1.5	1.5	37 000	39 500	6 300	8 500		
25.000	50.005	13.495	14.260	9.525	1.5	1.0	26 000	27 900	7 500	10 000	
51.994	15.011	14.260	12.700	1.5	1.3	26 000	27 900	7 500	10 000		
25.400	50.005	13.495	14.260	9.525	3.3	1.0	26 000	27 900	7 500	10 000	
50.005	13.495	14.260	9.525	1.0	1.0	26 000	27 900	7 500	10 000		
50.292	14.224	14.732	10.668	1.3	1.3	27 600	32 000	7 100	10 000		
57.150	17.462	17.462	13.495	1.3	1.5	39 500	45 500	6 700	9 000		
57.150	19.431	19.431	14.732	1.5	1.5	42 500	49 000	6 700	9 000		
59.530	23.368	23.114	18.288	0.8	1.5	50 000	58 000	6 300	9 000		
62.000	19.050	20.638	14.288	0.8	1.3	46 000	53 000	6 000	8 000		
63.500	20.638	20.638	15.875	3.5	1.5	46 000	53 000	6 000	8 000		
64.292	21.433	21.433	16.670	1.5	1.5	51 000	64 500	5 600	8 000		
65.088	22.225	21.463	15.875	1.5	1.5	45 000	47 500	5 600	8 000		
68.262	22.225	22.225	17.462	0.8	1.5	55 000	64 000	5 600	7 500		
72.233	25.400	25.400	19.842	0.8	2.3	63 500	83 500	5 000	7 100		
72.626	24.608	24.257	17.462	2.3	1.5	60 000	58 000	5 600	7 500		
26.988	50.292	14.224	14.732	10.668	3.5	1.3	27 600	32 000	7 100	10 000	
57.150	19.845	19.355	15.875	3.3	1.5	40 000	44 500	6 700	9 000		
60.325	19.842	17.462	15.875	3.5	1.5	39 500	45 500	6 700	9 000		
62.000	19.050	20.638	14.288	0.8	1.3	46 000	53 000	6 000	8 000		
28.575	57.150	19.845	19.355	15.875	3.5	1.5	40 000	44 500	6 700	9 000	
59.131	15.875	16.764	11.811	spec.	1.3	34 500	41 500	6 300	8 500		
62.000	19.050	20.638	14.288	3.5	1.3	46 000	53 000	6 000	8 000		
62.000	19.050	20.638	14.288	0.8	1.3	46 000	53 000	6 000	8 000		
64.292	21.433	21.433	16.670	1.5	1.5	51 000	64 500	5 600	8 000		
68.262	22.225	22.225	17.462	0.8	1.5	55 000	64 000	5 600	7 500		
72.626	24.608	24.257	17.462	4.8	1.5	60 000	58 000	5 600	7 500		
72.626	24.608	24.257	17.462	1.5	1.5	60 000	58 000	5 600	7 500		
73.025	22.225	22.225	17.462	0.8	3.3	54 500	64 500	5 300	7 100		

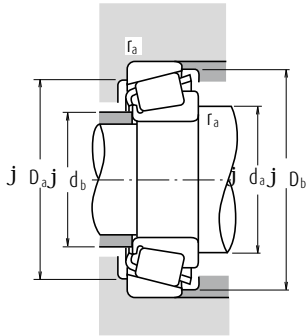

Dynamic Equivalent Load $P = X F_r + Y F_a$

$F_a/F_r \leq e$		$F_a/F_r > e$	
X	Y	X	Y
1	0	0.4	Y_1

Static Equivalent Load

$$P_0 = 0.5 F_r + Y_0 F_a$$

When $F_r > 0.5 F_r + Y_0 F_a$, use $P_0 = F_r$

The values of e , Y_1 and Y_0 are given in the table below.

Bearing Numbers		Abutment and Fillet Dimensions (mm)						Eff. Load Centers (mm)	Constant	Axial Load Factors		Mass (kg)	
CONE	CUP	d_a	d_b	D_a	D_b	Cone r_a max.	Cup			e	Y_1	Y_0	CONE
LM 72849	LM 72810	29	27	40.5	44.5	1.5	1	12.2	0.47	1.3	0.70	0.086	0.046
† L 44640	† L 44610	30.5	28.5	44.5	47	1.5	1.3	10.9	0.37	1.6	0.88	0.097	0.039
1779	1729	29.5	28.5	49	51	0.8	1.3	12.2	0.31	2.0	1.1	0.143	0.102
▲ JHM 33449	▲ JHM 33410	35	30	47	52	2	2	15.8	0.35	1.7	0.93	0.181	0.107
07098	07204	31	29	45	48	1.5	1.3	12.1	0.40	1.5	0.82	0.085	0.061
07098	07205	31	29	44.5	48	1.5	2	12.1	0.40	1.5	0.82	0.085	0.061
17098	17244	33	30.5	54	57	1.5	1.5	12.8	0.38	1.6	0.86	0.165	0.091
07097	07196	31	29	44.5	47	1.5	1	10.6	0.40	1.5	0.82	0.085	0.035
07097	07204	31	29	45	48	1.5	1.3	12.1	0.40	1.5	0.82	0.085	0.061
07100 SA	07196	35	29.5	44.5	47	3.3	1	10.6	0.40	1.5	0.82	0.082	0.035
07100	07196	30.5	29.5	44.5	47	1	1	10.6	0.40	1.5	0.82	0.084	0.035
† L 44643	† L 44610	31.5	29.5	44.5	47	1.3	1.3	10.9	0.37	1.6	0.88	0.090	0.039
15578	15520	32.5	30.5	51	53	1.3	1.5	12.4	0.35	1.7	0.95	0.151	0.070
M 84548	M 84510	36	33	48.5	54	1.5	1.5	16.1	0.55	1.1	0.60	0.156	0.089
M 84249	M 84210	36	32.5	49.5	56	0.8	1.5	18.3	0.55	1.1	0.60	0.194	0.13
15101	15245	32.5	31.5	55	58	0.8	1.3	13.3	0.35	1.7	0.94	0.222	0.081
15100	15250 X	38	31.5	55	59	3.5	1.5	14.9	0.35	1.7	0.94	0.22	0.113
M 86643	M 86610	38	36.5	54	61	1.5	1.5	17.7	0.55	1.1	0.60	0.246	0.128
23100	23256	39	34.5	53	61	1.5	1.5	20.0	0.73	0.82	0.45	0.214	0.142
02473	02420	34.5	33.5	59	63	0.8	1.5	16.9	0.42	1.4	0.79	0.28	0.152
HM 88630	HM 88610	39.5	39.5	60	69	0.8	2.3	20.7	0.55	1.1	0.60	0.398	0.188
41100	41286	41	36.5	61	68	2.3	1.5	20.7	0.60	1.0	0.55	0.32	0.177
† L 44649	† L 44610	37.5	31	44.5	47	3.5	1.3	10.9	0.37	1.6	0.88	0.081	0.039
1997 X	1922	37.5	31.5	51	53.5	3.3	1.5	13.9	0.33	1.8	1.0	0.152	0.077
15580	15523	38.5	32	51	54	3.5	1.5	14.7	0.35	1.7	0.95	0.141	0.123
15106	15245	33.5	33	55	58	0.8	1.3	13.3	0.35	1.7	0.94	0.211	0.081
1988	1922	39.5	33.5	51	53.5	3.5	1.5	13.9	0.33	1.8	1.0	0.141	0.077
† LM 67043	† LM 67010	40	33.5	52	56	3.5	1.3	12.6	0.41	1.5	0.80	0.147	0.062
15112	15245	40	34	55	58	3.5	1.3	13.3	0.35	1.7	0.94	0.199	0.081
15113	15245	34.5	34	55	58	0.8	1.3	13.3	0.35	1.7	0.94	0.20	0.081
M 86647	M 86610	40	38	54	61	1.5	1.5	17.7	0.55	1.1	0.60	0.223	0.128
02474	02420	36.5	36	59	63	0.8	1.5	16.9	0.42	1.4	0.79	0.257	0.152
41125	41286	48	36.5	61	68	4.8	1.5	20.7	0.60	1.0	0.55	0.292	0.177
41126	41286	41.5	36.5	61	68	1.5	1.5	20.7	0.60	1.0	0.55	0.295	0.177
02872	02820	37.5	37	62	68	0.8	3.3	18.3	0.45	1.3	0.73	0.321	0.16

Notes † The tolerances for the bore diameter and overall bearing width differ from the standard (See Table 5 on Page B203).

▲ The tolerances are listed in Tables 2, 3 and 4 on Pages B202 and B203.

Single-Row Tapered Roller Bearings (Inch Design)

Bore Diameter 29.000 – 32.000 mm

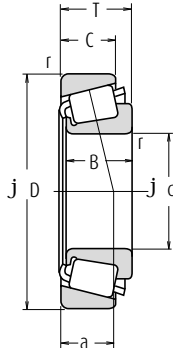

Boundary Dimensions (mm)							Basic Load Ratings (N)		Limiting Speeds (min ⁻¹)	
d	D	T	B	C	Cone	Cup	C_r	C_{Or}	Grease	Oil
					r min.	r min.				
29.000	50.292	14.224	14.732	10.668	3.5	1.3	26 800	34 000	7 100	9 500
29.367	66.421	23.812	25.433	19.050	3.5	1.3	65 000	73 000	6 000	8 000
30.000	62.000	16.002	16.566	14.288	1.5	1.5	37 000	39 500	6 300	8 500
	62.000	19.050	20.638	14.288	1.3	1.3	46 000	53 000	6 000	8 000
	63.500	20.638	20.638	15.875	1.3	1.3	46 000	53 000	6 000	8 000
	72.000	19.000	18.923	15.875	1.5	1.5	52 000	56 000	5 600	7 500
30.112	62.000	19.050	20.638	14.288	0.8	1.3	46 000	53 000	6 000	8 000
30.162	58.738	14.684	15.080	10.716	3.5	1.0	28 800	33 500	6 000	8 000
	64.292	21.433	21.433	16.670	1.5	1.5	51 000	64 500	5 600	8 000
	68.262	22.225	22.225	17.462	2.3	1.5	55 500	70 500	5 300	7 500
	69.850	23.812	25.357	19.050	2.3	1.3	71 000	84 000	5 600	7 500
	69.850	23.812	25.357	19.050	0.8	1.3	71 000	84 000	5 600	7 500
30.213	76.200	24.608	24.074	16.670	1.5	C3.3	67 500	69 500	5 000	6 700
	62.000	19.050	20.638	14.288	3.5	1.3	46 000	53 000	6 000	8 000
	62.000	19.050	20.638	14.288	0.8	1.3	46 000	53 000	6 000	8 000
30.955	62.000	19.050	20.638	14.288	1.5	1.3	46 000	53 000	6 000	8 000
	64.292	21.433	21.433	16.670	1.5	1.5	51 000	64 500	5 600	8 000
31.750	58.738	14.684	15.080	10.716	1.0	1.0	28 800	33 500	6 000	8 000
	59.131	15.875	16.764	11.811	spec.	1.3	34 500	41 500	6 300	8 500
	62.000	18.161	19.050	14.288	spec.	1.3	46 000	53 000	6 000	8 000
	62.000	19.050	20.638	14.288	0.8	1.3	46 000	53 000	6 000	8 000
	62.000	19.050	20.638	14.288	3.5	1.3	46 000	53 000	6 000	8 000
	63.500	20.638	20.638	15.875	0.8	1.3	46 000	53 000	6 000	8 000
	68.262	22.225	22.225	17.462	3.5	1.5	55 000	64 000	5 600	7 500
	68.262	22.225	22.225	17.462	1.5	1.5	55 500	70 500	5 300	7 500
	69.012	19.845	19.583	15.875	3.5	1.3	47 000	56 000	5 600	7 500
	69.012	26.982	26.721	15.875	4.3	3.3	47 000	56 000	5 600	7 500
	69.850	23.812	25.357	19.050	0.8	1.3	71 000	84 000	5 600	7 500
	69.850	23.812	25.357	19.050	3.5	1.3	71 000	84 000	5 600	7 500
	72.626	30.162	29.997	23.812	0.8	3.3	79 500	90 000	5 300	7 500
	73.025	29.370	27.783	23.020	1.3	3.3	74 000	100 000	5 000	7 100
	80.000	21.000	22.403	17.826	0.8	1.3	68 500	75 500	4 500	6 300
	32.000	72.233	25.400	25.400	19.842	3.3	2.3	63 500	83 500	5 000

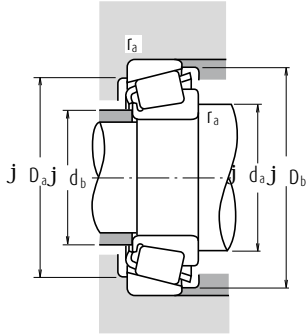

Dynamic Equivalent Load $P = X F_r + Y F_a$

$F_a/F_r \leq e$		$F_a/F_r > e$	
X	Y	X	Y
1	0	0.4	Y_1

Static Equivalent Load

$$P_0 = 0.5 F_r + Y_0 F_a$$

When $F_r > 0.5 F_r + Y_0 F_a$, use $P_0 = F_r$

The values of e , Y_1 and Y_0 are given in the table below.

Bearing Numbers		Abutment and Fillet Dimensions (mm)						Eff. Load Centers (mm)	Constant	Axial Load Factors		Mass (kg)	
CONE	CUP	d_a	d_b	D_a	D_b	Cone r_a max.	Cup			Y_1	Y_0	CONE	CUP
† L 45449	† L 45410	39.5	33	44.5	48	3.5	1.3	10.8	0.37	1.6	0.89	0.079	0.036
2690	2631	41	35	58	60	3.5	1.3	14.3	0.25	2.4	1.3	0.242	0.165
* 17118	17244	37	34.5	54	57	1.5	1.5	12.8	0.38	1.6	0.86	0.136	0.091
* 15117	15245	36.5	35	55	58	1.3	1.3	13.3	0.35	1.7	0.94	0.189	0.081
* 15117	15250	36.5	35	56	59	1.3	1.3	14.9	0.35	1.7	0.94	0.189	0.113
* 26118	26283	38	36	62	65	1.5	1.5	14.8	0.36	1.7	0.92	0.225	0.163
15116	15245	36	35.5	55	58	0.8	1.3	13.3	0.35	1.7	0.94	0.189	0.081
08118	08231	41.5	35	52	55	3.5	1	13.3	0.47	1.3	0.70	0.12	0.057
M 86649	M 86610	41	38	54	61	1.5	1.5	17.7	0.55	1.1	0.60	0.211	0.128
M 88043	M 88010	43.5	39.5	58	65	2.3	1.5	19.1	0.55	1.1	0.60	0.263	0.146
2558	2523	40	36.5	61	64	2.3	1.3	14.5	0.27	2.2	1.2	0.297	0.169
2559	2523	37	36.5	61	64	0.8	1.3	14.5	0.27	2.2	1.2	0.298	0.169
43118	43300	45	42	64	73	1.5	3.3	22.9	0.67	0.90	0.49	0.383	0.146
15118	15245	41.5	35.5	55	58	3.5	1.3	13.3	0.35	1.7	0.94	0.186	0.081
15120	15245	36	35.5	55	58	0.8	1.3	13.3	0.35	1.7	0.94	0.188	0.081
15119	15245	37.5	35.5	55	58	1.5	1.3	13.3	0.35	1.7	0.94	0.188	0.081
M 86648 A	M 86610	42	38	54	61	1.5	1.5	17.7	0.55	1.1	0.60	0.205	0.128
08125	08231	37.5	36	52	55	1	1	13.3	0.47	1.3	0.70	0.113	0.057
† LM 67048	† LM 67010	42.5	36	52	56	3.5	1.3	12.6	0.41	1.5	0.80	0.127	0.062
15123	15245	42.5	36.5	55	58	3.5	1.3	13.3	0.35	1.7	0.94	0.165	0.081
15126	15245	37	36.5	55	58	0.8	1.3	13.3	0.35	1.7	0.94	0.176	0.081
15125	15245	42.5	36.5	55	58	3.5	1.3	13.3	0.35	1.7	0.94	0.174	0.081
15126	15250	37	36.5	56	59	0.8	1.3	14.9	0.35	1.7	0.94	0.176	0.113
02475	02420	44.5	38.5	59	63	3.5	1.5	16.9	0.42	1.4	0.79	0.229	0.152
M 88046	M 88010	43	40.5	58	65	1.5	1.5	19.1	0.55	1.1	0.60	0.25	0.146
14125 A	14276	44	37.5	60	63	3.5	1.3	15.3	0.38	1.6	0.86	0.219	0.135
14123 A	14274	41.5	37.5	59	63	4.3	3.3	15.1	0.38	1.6	0.87	0.289	0.132
2580	2523	38.5	37.5	61	64	0.8	1.3	14.5	0.27	2.2	1.2	0.282	0.169
2582	2523	44	37.5	61	64	3.5	1.3	14.5	0.27	2.2	1.2	0.28	0.169
3188	3120	39.5	39.5	61	67	0.8	3.3	19.6	0.33	1.8	0.99	0.368	0.225
HM 88542	HM 88510	45.5	42.5	59	70	1.3	3.3	23.5	0.55	1.1	0.60	0.379	0.242
346	332	40	39.5	73	75	0.8	1.3	14.6	0.27	2.2	1.2	0.419	0.146
* HM 88638	HM 88610	48.5	42.5	60	69	3.3	2.3	20.7	0.55	1.1	0.60	0.337	0.188

Notes * The maximum bore diameter is listed and its tolerance is negative (See Table 7.4.1 on Page A136).

† The tolerances for the bore diameter and overall bearing width differ from the standard (See Table 5 on Page B203).

Single-Row Tapered Roller Bearings (Inch Design)

Bore Diameter 33.338 – 35.000 mm

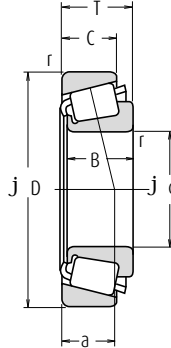

d	Boundary Dimensions (mm)					Basic Load Ratings (N)		Limiting Speeds (min ⁻¹)		
	D	T	B	C	Cone	Cup	C _r	C _{0r}	Grease	Oil
					r min.	r				
33.338	66.675	20.638	20.638	15.875	3.5	1.5	46 000	53 500	5 600	7 500
	68.262	22.225	22.225	17.462	0.8	1.5	55 500	70 500	5 300	7 500
	69.012	19.845	19.583	15.875	3.5	3.3	47 000	56 000	5 600	7 500
	69.012	19.845	19.583	15.875	0.8	1.3	47 000	56 000	5 600	7 500
	69.850	23.812	25.357	19.050	3.5	1.3	71 000	84 000	5 600	7 500
	72.000	19.000	18.923	15.875	3.5	1.5	52 000	56 000	5 600	7 500
	72.626	30.162	29.997	23.812	0.8	3.3	79 500	90 000	5 300	7 500
	73.025	29.370	27.783	23.020	0.8	3.3	74 000	100 000	5 000	7 100
	76.200	29.370	28.575	23.020	3.8	0.8	78 500	106 000	4 800	6 700
	76.200	29.370	28.575	23.020	0.8	3.3	78 500	106 000	4 800	6 700
34.925	79.375	25.400	24.074	17.462	3.5	1.5	67 500	69 500	5 000	6 700
	65.088	18.034	18.288	13.970	spec.	1.3	47 500	57 500	5 600	7 500
	65.088	20.320	18.288	16.256	spec.	1.3	47 500	57 500	5 600	7 500
	66.675	20.638	20.638	16.670	3.5	2.3	53 000	62 500	5 600	7 500
	69.012	19.845	19.583	15.875	3.5	1.3	47 000	56 000	5 600	7 500
	69.012	19.845	19.583	15.875	1.5	1.3	47 000	56 000	5 600	7 500
	72.233	25.400	25.400	19.842	2.3	2.3	63 500	83 500	5 000	7 100
	73.025	22.225	22.225	17.462	0.8	3.3	54 500	64 500	5 300	7 100
	73.025	22.225	23.812	17.462	3.5	3.3	63 500	77 000	5 300	7 100
	73.025	23.812	24.608	19.050	1.5	0.8	71 000	86 000	5 300	7 100
34.976	73.025	23.812	24.608	19.050	3.5	2.3	71 000	86 000	5 300	7 100
	76.200	29.370	28.575	23.020	0.8	0.8	78 500	106 000	4 800	6 700
	76.200	29.370	28.575	23.020	3.5	0.8	78 500	106 000	4 800	6 700
	76.200	29.370	28.575	23.020	3.5	3.3	78 500	106 000	4 800	6 700
	76.200	29.370	28.575	23.812	1.5	3.3	80 500	96 500	5 000	6 700
	79.375	29.370	29.771	23.812	3.5	3.3	88 000	106 000	4 800	6 700
	68.262	15.875	16.520	11.908	1.5	1.5	45 000	53 500	5 300	7 100
	72.085	22.385	19.583	18.415	1.3	2.3	47 000	56 000	5 600	7 500
	80.000	21.006	20.940	15.875	1.5	1.5	56 500	64 500	5 000	6 700
	35.000	59.131	15.875	16.764	11.938	spec.	1.3	35 000	47 000	6 000
59.975		15.875	16.764	11.938	spec.	1.3	35 000	47 000	6 000	8 000
62.000		16.700	17.000	13.600	spec.	1.0	38 000	50 000	5 600	8 000
62.000		16.700	17.000	13.600	spec.	1.5	38 000	50 000	5 600	8 000
65.987		20.638	20.638	16.670	3.5	2.3	53 000	62 500	5 600	7 500
73.025		26.988	26.975	22.225	3.5	0.8	75 500	88 500	5 300	7 500

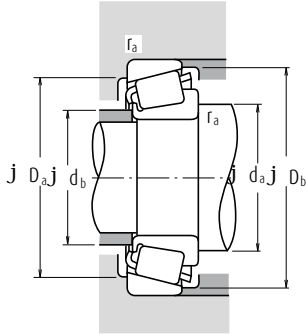

Dynamic Equivalent Load $P = X F_r + Y F_a$

$F_a/F_r \leq e$		$F_a/F_r > e$	
X	Y	X	Y
1	0	0.4	Y_1

Static Equivalent Load

$$P_0 = 0.5 F_r + Y_0 F_a$$

When $F_r > 0.5 F_r + Y_0 F_a$, use $P_0 = F_r$

The values of e , Y_1 and Y_0 are given in the table below.

Bearing Numbers		Abutment and Fillet Dimensions (mm)						Eff. Load Centers (mm)	Constant	Axial Load Factors		Mass (kg)	
CONE	CUP	d_a	d_b	D_a	D_b	Cone r_a max.	Cup			Y_1	Y_0	CONE	CUP
1680	1620	44.5	38.5	58	61	3.5	1.5	15.2	0.37	1.6	0.89	0.196	0.121
M 88048	M 88010	42.5	41	58	65	0.8	1.5	19.0	0.55	1.1	0.60	0.236	0.146
14130	14274	45	38.5	59	63	3.5	3.3	15.3	0.38	1.6	0.86	0.207	0.132
14131	14276	39.5	38.5	60	63	0.8	1.3	15.3	0.38	1.6	0.86	0.209	0.135
2585	2523	45	39	61	64	3.5	1.3	14.5	0.27	2.2	1.2	0.263	0.169
26131	26283	44.5	38.5	62	65	3.5	1.5	14.7	0.36	1.7	0.92	0.20	0.163
3197	3120	41.5	40.5	61	67	0.8	3.3	19.6	0.33	1.8	0.99	0.348	0.225
HM 88547	HM 88510	45.5	42.5	59	70	0.8	3.3	23.5	0.55	1.1	0.60	0.362	0.242
HM 89444	HM 89411	53	44.5	65	73	3.8	0.8	23.6	0.55	1.1	0.60	0.419	0.261
HM 89443	HM 89410	46.5	44.5	62	73	0.8	3.3	23.6	0.55	1.1	0.60	0.421	0.257
43131	43312	51	42	67	74	3.5	1.5	23.7	0.67	0.90	0.49	0.348	0.22
† LM 48548	† LM 48510	46	40	58	61	3.5	1.3	14.1	0.38	1.6	0.88	0.172	0.087
† LM 48548	† LM 48511	46	40	58	61	3.5	1.3	16.4	0.38	1.6	0.88	0.172	0.108
M 38549	M 38510	46.5	40	58	62	3.5	2.3	15.2	0.35	1.7	0.94	0.194	0.112
14138 A	14276	46	40	60	63	3.5	1.3	15.3	0.38	1.6	0.86	0.194	0.135
14137 A	14276	42	40	60	63	1.5	1.3	15.1	0.38	1.6	0.86	0.196	0.135
HM 88649	HM 88610	48.5	42.5	60	69	2.3	2.3	20.7	0.55	1.1	0.60	0.307	0.188
02878	02820	42.5	42	62	68	0.8	3.3	18.3	0.45	1.3	0.73	0.266	0.16
2877	2820	47	41.5	63	68	3.5	3.3	16.1	0.37	1.6	0.90	0.291	0.15
25877	25821	43	40.5	65	68	1.5	0.8	15.7	0.29	2.1	1.1	0.306	0.167
25878	25820	47	40.5	64	68	3.5	2.3	15.7	0.29	2.1	1.1	0.304	0.165
HM 89446 A	HM 89411	47.5	44.5	65	73	0.8	0.8	23.6	0.55	1.1	0.60	0.403	0.261
HM 89446	HM 89411	53	44.5	65	73	3.5	0.8	23.6	0.55	1.1	0.60	0.40	0.261
HM 89446	HM 89410	53	44.5	62	73	3.5	3.3	23.6	0.55	1.1	0.60	0.40	0.257
31594	31520	46	43.5	64	72	1.5	3.3	21.6	0.40	1.5	0.82	0.404	0.235
3478	3420	50	43.5	67	74	3.5	3.3	20.0	0.37	1.6	0.90	0.448	0.259
19138	19268	42.5	40.5	61	65	1.5	1.5	14.5	0.44	1.4	0.74	0.196	0.073
14139	14283	41.5	40	60	65	1.3	2.3	17.7	0.38	1.6	0.87	0.198	0.21
28138	28315	43.5	41	69	73	1.5	1.5	16.0	0.40	1.5	0.82	0.308	0.199
* † L 68149	† L 68110	45.5	39	52	56	3.5	1.3	13.2	0.42	1.4	0.79	0.117	0.056
* † L 68149	† L 68111	45.5	39	53	56	3.5	1.3	13.2	0.42	1.4	0.79	0.117	0.064
* LM 78349	** LM 78310	46	40	55	59	3.5	1	14.4	0.44	1.4	0.74	0.137	0.074
* LM 78349	** LM 78310 A	46	40	54	59	3.5	1.5	14.4	0.44	1.4	0.74	0.138	0.073
M 38547	M 38511	46	39.5	59	61	3.5	2.3	15.2	0.35	1.7	0.94	0.193	0.103
23691	23621	49	42	63	68	3.5	0.8	18.1	0.37	1.6	0.89	0.309	0.212

Notes

- * The maximum bore diameter is listed and its tolerance is negative (See Table 7.4.1 on Page A136).
- ** The maximum outside diameter is listed and its tolerance is negative (See Table 7.4.2 on Pages A136 and A137).
- † The tolerances for the bore diameter and overall bearing width differ from the standard (See Table 5 on Page B203).
- *† The tolerance for the bore diameter is 0 to $-20 \mu\text{m}$, and for overall bearing width is $+356$ to $0 \mu\text{m}$.

Single-Row Tapered Roller Bearings (Inch Design)

Bore Diameter 35.717 – 41.275 mm

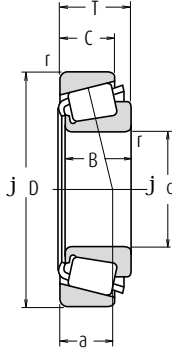

d	Boundary Dimensions (mm)				Cone		Cup		Basic Load Ratings (N)		Limiting Speeds (min ⁻¹)	
	D	T	B	C	r min.	r	C _r	C _{0r}	Grease	Oil		
35.717	72.233	25.400	25.400	19.842	3.5	2.3	63 500	83 500	5 000	7 100		
36.487	73.025	23.812	24.608	19.050	1.5	0.8	71 000	86 000	5 300	7 100		
36.512	76.200	29.370	28.575	23.020	3.5	3.3	78 500	106 000	4 800	6 700		
	79.375	29.370	29.771	23.812	0.8	3.3	88 000	106 000	4 800	6 700		
	88.501	25.400	23.698	17.462	2.3	1.5	73 000	81 000	4 000	5 600		
	93.662	31.750	31.750	26.195	1.5	3.3	110 000	142 000	4 000	5 600		
38.000	63.000	17.000	17.000	13.500	spec.	1.3	38 500	52 000	5 600	7 500		
38.100	63.500	12.700	11.908	9.525	1.5	0.8	24 100	30 500	5 300	7 100		
	65.088	18.034	18.288	13.970	2.3	1.3	42 500	55 000	5 300	7 500		
	65.088	18.034	18.288	13.970	spec.	1.3	42 500	55 000	5 300	7 500		
	65.088	19.812	18.288	15.748	2.3	1.3	42 500	55 000	5 300	7 500		
	68.262	15.875	16.520	11.908	1.5	1.5	45 000	53 500	5 300	7 100		
	69.012	19.050	19.050	15.083	2.0	2.3	49 000	61 000	5 300	7 100		
	69.012	19.050	19.050	15.083	3.5	0.8	49 000	61 000	5 300	7 100		
	72.238	20.638	20.638	15.875	3.5	1.3	48 500	59 500	5 300	7 100		
	73.025	23.812	25.654	19.050	3.5	0.8	73 500	91 000	5 000	6 700		
	76.200	23.812	25.654	19.050	3.5	3.3	73 500	91 000	5 000	6 700		
76.200	23.812	25.654	19.050	3.5	0.8	73 500	91 000	5 000	6 700			
79.375	29.370	29.771	23.812	3.5	3.3	88 000	106 000	4 800	6 700			
80.035	24.608	23.698	18.512	0.8	1.5	69 000	84 500	4 500	6 300			
82.550	29.370	28.575	23.020	0.8	3.3	87 000	117 000	4 500	6 000			
88.501	25.400	23.698	17.462	2.3	1.5	73 000	81 000	4 000	5 600			
88.501	26.988	29.083	22.225	3.5	1.5	96 500	109 000	4 500	6 000			
95.250	30.958	28.301	20.638	1.5	0.8	87 500	97 000	3 600	5 300			
39.688	73.025	25.654	22.098	21.336	0.8	2.3	62 500	80 000	5 000	6 700		
	76.200	23.812	25.654	19.050	3.5	3.3	73 500	91 000	5 000	6 700		
	80.167	29.370	30.391	23.812	0.8	3.3	92 500	108 000	4 800	6 300		
40.000	80.000	21.000	22.403	17.826	3.5	1.3	68 500	75 500	4 500	6 300		
	80.000	21.000	22.403	17.826	0.8	1.3	68 500	75 500	4 500	6 300		
	88.501	25.400	23.698	17.462	2.3	1.5	73 000	81 000	4 000	5 600		
	41.000	68.000	17.500	18.000	13.500	spec.	1.5	43 500	58 000	5 300	7 100	
41.275	73.025	16.667	17.462	12.700	3.5	1.5	44 500	54 000	4 800	6 700		
	73.431	19.558	19.812	14.732	3.5	0.8	54 500	67 000	4 800	6 700		
	73.431	21.430	19.812	16.604	3.5	0.8	54 500	67 000	4 800	6 700		

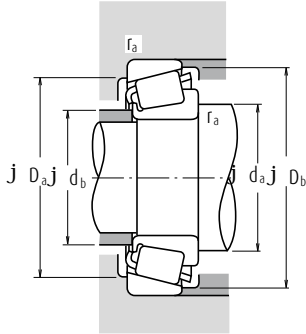

Dynamic Equivalent Load $P = X F_r + Y F_a$

$F_a/F_r \leq e$		$F_a/F_r > e$	
X	Y	X	Y
1	0	0.4	Y_1

Static Equivalent Load

$$P_0 = 0.5 F_r + Y_0 F_a$$

When $F_r > 0.5 F_r + Y_0 F_a$, use $P_0 = F_r$

The values of e , Y_1 and Y_0 are given in the table below.

Bearing Numbers		Abutment and Fillet Dimensions (mm)						Eff. Load Centers (mm)	Constant	Axial Load Factors		Mass (kg)	
CONE	CUP	d_a	d_b	D_a	D_b	Cone r_a max.	Cup			Y_1	Y_0	CONE	CUP
HM 88648	HM 88610	52	43	60	69	3.5	2.3	20.7	0.55	1.1	0.60	0.298	0.188
25880	25821	44	42	65	68	1.5	0.8	15.7	0.29	2.1	1.1	0.291	0.167
HM 89449	HM 89410	54	44.5	62	73	3.5	3.3	23.6	0.55	1.1	0.60	0.38	0.257
3479	3420	45.5	44.5	67	74	0.8	3.3	20.0	0.37	1.6	0.90	0.429	0.259
44143	44348	54	50	75	84	2.3	1.5	27.9	0.78	0.77	0.42	0.502	0.245
46143	46368	48.5	46.5	79	87	1.5	3.3	24.0	0.40	1.5	0.82	0.765	0.405
▲ JL 69349	▲ JL 69310	49	42.5	56	60	3.5	1.3	14.6	0.42	1.4	0.79	0.132	0.071
13889	13830	45	42.5	59	60	1.5	0.8	11.9	0.35	1.7	0.95	0.109	0.046
LM 29749	LM 29710	46	42.5	59	62	2.3	1.3	13.7	0.33	1.8	0.99	0.16	0.079
LM 29748	LM 29710	49	42.5	59	62	3.5	1.3	13.7	0.33	1.8	0.99	0.158	0.079
LM 29749	LM 29711	46	42.5	58	62	2.3	1.3	15.5	0.33	1.8	0.99	0.16	0.094
19150	19268	45	43	61	65	1.5	1.5	14.5	0.44	1.4	0.74	0.173	0.073
13687	13621	46.5	43	61	65	2	2.3	15.8	0.40	1.5	0.82	0.193	0.104
13685	13620	49.5	43	62	65	3.5	0.8	15.8	0.40	1.5	0.82	0.191	0.105
16150	16284	49.5	43	63	67	3.5	1.3	16.0	0.40	1.5	0.82	0.212	0.146
2788	2735 X	50	43.5	66	69	3.5	0.8	15.9	0.30	2.0	1.1	0.312	0.135
2788	2720	50	43.5	66	70	3.5	3.3	15.9	0.30	2.0	1.1	0.312	0.187
2788	2729	50	43.5	68	70	3.5	0.8	15.9	0.30	2.0	1.1	0.312	0.191
3490	3420	52	45.5	67	74	3.5	3.3	20.0	0.37	1.6	0.90	0.404	0.259
27880	27820	48	47	68	75	0.8	1.5	21.5	0.56	1.1	0.59	0.362	0.209
HM 801346	HM 801310	51	49	68	78	0.8	3.3	24.2	0.55	1.1	0.60	0.483	0.282
44150	44348	55	51	75	84	2.3	1.5	27.9	0.78	0.77	0.42	0.484	0.245
418	414	51	44.5	77	80	3.5	1.5	17.1	0.26	2.3	1.3	0.50	0.329
53150	53375	55	53	81	89	1.5	0.8	30.7	0.74	0.81	0.45	0.665	0.365
M 201047	M 201011	45.5	48	64	69	0.8	2.3	19.7	0.33	1.8	0.99	0.266	0.169
2789	2720	52	45	66	70	3.5	3.3	15.9	0.30	2.0	1.1	0.292	0.187
3386	3320	46.5	45.5	70	75	0.8	3.3	18.4	0.27	2.2	1.2	0.442	0.217
344	332	52	45.5	73	75	3.5	1.3	14.5	0.27	2.2	1.2	0.338	0.146
344 A	332	46	45.5	73	75	0.8	1.3	14.5	0.27	2.2	1.2	0.339	0.146
44157	44348	56	51	75	84	2.3	1.5	27.9	0.78	0.77	0.42	0.463	0.245
* LM 300849	** LM 300811	52	45	61	65	3.5	1.5	13.9	0.35	1.7	0.95	0.16	0.082
18590	18520	53	46	66	69	3.5	1.5	14.0	0.35	1.7	0.94	0.199	0.086
LM 501349	LM 501310	53	46.5	67	70	3.5	0.8	16.3	0.40	1.5	0.83	0.226	0.108
LM 501349	LM 501314	53	46.5	66	70	3.5	0.8	18.2	0.40	1.5	0.83	0.226	0.129

- Notes**
- * The maximum bore diameter is listed and its tolerance is negative (See Table 7.4.1 on Page A136).
 - ** The maximum outside diameter is listed and its tolerance is negative (See Table 7.4.2 on Pages A136 and A137).
 - ▲ The tolerances are listed in Tables 2, 3 and 4 on Pages B202 and B203.

Single-Row Tapered Roller Bearings (Inch Design)

Bore Diameter 41.275 – 44.450 mm

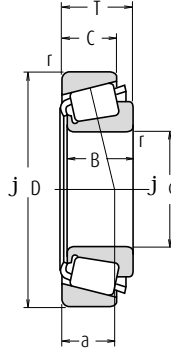

d	Boundary Dimensions (mm)				Cone		Cup		Basic Load Ratings (N)		Limiting Speeds (min ⁻¹)	
	D	T	B	C	r min.	r	C _r	C _{0r}	Grease	Oil		
41.275	76.200	18.009	17.384	14.288	1.5	1.5	42 500	51 000	4 500	6 300		
	76.200	22.225	23.020	17.462	3.5	0.8	66 000	82 000	4 800	6 700		
	76.200	25.400	23.020	20.638	3.5	2.3	66 000	82 000	4 800	6 700		
	79.375	23.812	25.400	19.050	3.5	0.8	77 000	98 500	4 800	6 300		
	80.000	21.000	22.403	17.826	0.8	1.3	68 500	75 500	4 500	6 300		
	80.000	21.000	22.403	17.826	3.5	1.3	68 500	75 500	4 500	6 300		
	80.167	25.400	25.400	20.638	3.5	3.3	77 000	98 500	4 800	6 300		
	82.550	26.543	25.654	20.193	3.5	3.3	78 500	102 000	4 300	6 000		
	85.725	30.162	30.162	23.812	3.5	3.3	91 000	115 000	4 300	6 000		
	87.312	30.162	30.886	23.812	0.8	3.3	96 000	120 000	4 300	6 000		
88.501	25.400	23.698	17.462	2.3	1.5	69 000	75 500	4 000	5 600			
88.900	30.162	29.370	23.020	3.5	3.3	96 500	129 000	4 000	5 600			
88.900	30.162	29.370	23.020	0.8	3.3	96 500	129 000	4 000	5 600			
90.488	39.688	40.386	33.338	3.5	3.3	139 000	180 000	4 300	5 600			
93.662	31.750	31.750	26.195	0.8	3.3	110 000	142 000	4 000	5 600			
95.250	30.162	29.370	23.020	3.5	3.3	106 000	143 000	3 800	5 300			
98.425	30.958	28.301	20.638	1.5	0.8	87 500	97 000	3 600	5 300			
42.862	76.992	17.462	17.145	11.908	1.5	1.5	44 000	54 000	4 500	6 000		
	82.550	19.842	19.837	15.080	2.3	1.5	58 500	69 000	4 500	6 300		
	82.931	23.812	25.400	19.050	2.3	0.8	76 500	99 000	4 500	6 000		
	82.931	26.988	25.400	22.225	2.3	2.3	76 500	99 000	4 500	6 000		
42.875	76.200	25.400	25.400	20.638	3.5	1.5	77 000	98 500	4 800	6 300		
	80.000	21.000	22.403	17.826	3.5	1.3	68 500	75 500	4 500	6 300		
	82.931	26.988	25.400	22.225	3.5	2.3	76 500	99 000	4 500	6 000		
	83.058	23.812	25.400	19.050	3.5	3.3	76 500	99 000	4 500	6 000		
43.000	74.988	19.368	19.837	14.288	1.5	1.3	52 500	68 000	4 800	6 300		
	80.962	19.050	17.462	14.288	0.3	1.5	45 000	57 000	4 300	6 000		
44.450	82.931	23.812	25.400	19.050	3.5	0.8	76 500	99 000	4 500	6 000		
	83.058	23.812	25.400	19.050	3.5	3.3	76 500	99 000	4 500	6 000		
	87.312	30.162	30.886	23.812	3.5	3.3	96 000	120 000	4 300	6 000		
	88.900	30.162	29.370	23.020	3.5	3.3	96 500	129 000	4 000	5 600		
	93.264	30.162	30.302	23.812	3.5	3.2	103 000	136 000	3 800	5 300		
	93.662	31.750	31.750	25.400	0.8	3.3	120 000	147 000	4 000	5 600		
	93.662	31.750	31.750	25.400	3.5	3.3	120 000	147 000	4 000	5 600		
	93.662	31.750	31.750	26.195	3.5	3.3	110 000	142 000	4 000	5 600		
	95.250	27.783	29.901	22.225	3.5	2.3	106 000	126 000	4 300	5 600		

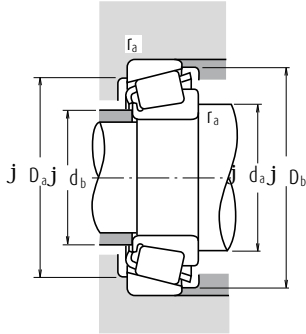

Dynamic Equivalent Load $P = X F_r + Y F_a$

$F_a/F_r \leq e$		$F_a/F_r > e$	
X	Y	X	Y
1	0	0.4	Y_1

Static Equivalent Load

$$P_0 = 0.5 F_r + Y_0 F_a$$

When $F_r > 0.5 F_r + Y_0 F_a$, use $P_0 = F_r$

The values of e , Y_1 and Y_0 are given in the table below.

Bearing Numbers		Abutment and Fillet Dimensions (mm)					Cone Cup r_a max.	Eff. Load Centers (mm) a	Constant e	Axial Load Factors		Mass (kg)	
CONE	CUP	d_a	d_b	D_a	D_b	Y_1				Y_0	CONE	CUP	
11162	11300	49	46.5	67	71	1.5	1.5	17.4	0.49	1.2	0.68	0.212	0.129
24780	24720	53	47.5	68	72	3.5	0.8	17.0	0.39	1.5	0.84	0.279	0.15
24780	24721	54	47	66	72	3.5	2.3	20.2	0.39	1.5	0.84	0.279	0.189
26882	26822	54	47	71	74	3.5	0.8	16.4	0.32	1.9	1.0	0.349	0.186
336	332	47	46	73	75	0.8	1.3	14.5	0.27	2.2	1.2	0.325	0.146
342	332	53	46	73	75	3.5	1.3	14.5	0.27	2.2	1.2	0.323	0.146
26882	26820	54	47	69	74	3.5	3.3	18.0	0.32	1.9	1.0	0.349	0.219
M 802048	M 802011	57	51	70	79	3.5	3.3	22.9	0.55	1.1	0.60	0.406	0.23
3877	3820	57	50	73	81	3.5	3.3	21.8	0.40	1.5	0.82	0.506	0.285
3576	3525	49	48	75	81	0.8	3.3	19.5	0.31	2.0	1.1	0.532	0.304
44162	44348	57	51	75	84	2.3	1.5	28.0	0.78	0.77	0.42	0.447	0.245
HM 803146	HM 803110	60	53	74	85	3.5	3.3	25.6	0.55	1.1	0.60	0.579	0.322
HM 803145	HM 803110	54	53	74	85	0.8	3.3	25.6	0.55	1.1	0.60	0.582	0.322
4388	4335	57	51	77	85	3.5	3.3	24.6	0.28	2.1	1.2	0.789	0.459
46162	46368	52	51	79	87	0.8	3.3	24.0	0.40	1.5	0.82	0.695	0.405
HM 804840	HM 804810	61	54	81	91	3.5	3.3	26.1	0.55	1.1	0.60	0.726	0.354
53162	53387	57	53	82	91	1.5	0.8	30.7	0.74	0.81	0.45	0.618	0.442
12168	12303	51	48.5	68	73	1.5	1.5	17.7	0.51	1.2	0.65	0.228	0.098
22168	22325	52	48.5	73	76	2.3	1.5	17.6	0.43	1.4	0.77	0.283	0.176
25578	25520	53	49.5	74	77	2.3	0.8	17.6	0.33	1.8	0.99	0.383	0.203
25578	25523	53	49.5	72	77	2.3	2.3	20.8	0.33	1.8	0.99	0.383	0.248
26884	26823	55	48.5	69	73	3.5	1.5	18.0	0.32	1.9	1.0	0.337	0.136
342 S	332	54	47.5	73	75	3.5	1.3	14.5	0.27	2.2	1.2	0.305	0.146
25577	25523	55	49	72	77	3.5	2.3	20.8	0.33	1.8	0.99	0.381	0.248
25577	25521	55	49	72	77	3.5	3.3	17.6	0.33	1.8	0.99	0.381	0.201
* 16986	16929	51	48.5	67	71	1.5	1.3	17.2	0.44	1.4	0.74	0.24	0.106
13175	13318	50	50	72	76	0.3	1.5	20.1	0.53	1.1	0.63	0.252	0.144
25580	25520	57	50	74	77	3.5	0.8	17.6	0.33	1.8	0.99	0.359	0.203
25580	25521	56	51	72	78	3.5	3.3	17.6	0.33	1.8	0.99	0.359	0.201
3578	3525	57	51	75	81	3.5	3.3	19.5	0.31	2.0	1.1	0.477	0.304
HM 803149	HM 803110	62	53	74	85	3.5	3.3	25.6	0.55	1.1	0.60	0.528	0.322
3782	3720	58	52	82	88	3.5	3.2	22.4	0.34	1.8	0.97	0.678	0.292
49176	49368	54	53	82	87	0.8	3.3	21.6	0.36	1.7	0.92	0.648	0.371
49175	49368	59	53	82	87	3.5	3.3	21.6	0.36	1.7	0.92	0.645	0.371
46176	46368	60	54	79	87	3.5	3.3	24.0	0.40	1.5	0.82	0.635	0.405
438	432	57	51	83	87	3.5	2.3	18.6	0.28	2.1	1.2	0.555	0.384

Note * The maximum bore diameter is listed and its tolerance is negative (See Table 7.4.1 on Page A136).

Single-Row Tapered Roller Bearings (Inch Design)

Bore Diameter 44.450 – 47.625 mm

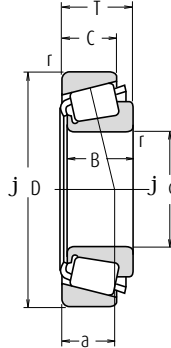

Boundary Dimensions (mm)							Basic Load Ratings (N)		Limiting Speeds (min ⁻¹)	
d	D	T	B	C	Cone	Cup	C _r	C _{0r}	Grease	Oil
					r	r				
					min.	min.				
44.450	95.250	30.162	29.370	23.020	3.5	3.3	106 000	143 000	3 800	5 300
	95.250	30.958	28.301	20.638	3.5	0.8	87 500	97 000	3 600	5 300
	95.250	30.958	28.301	20.638	1.3	0.8	87 500	97 000	3 600	5 300
	95.250	30.958	28.301	20.638	2.0	0.8	87 500	97 000	3 600	5 300
	95.250	30.958	28.301	22.225	1.3	0.8	100 000	122 000	3 600	5 000
	95.250	30.958	28.575	22.225	3.5	0.8	100 000	122 000	3 600	5 000
	98.425	30.958	28.301	20.638	3.5	0.8	87 500	97 000	3 600	5 300
	103.188	43.658	44.475	36.512	1.3	3.3	178 000	238 000	3 800	5 000
	104.775	36.512	36.512	28.575	3.5	3.3	139 000	192 000	3 400	4 800
	107.950	27.783	29.317	22.225	3.5	0.8	116 000	149 000	3 400	4 800
111.125	30.162	26.909	20.638	3.5	3.3	92 500	110 000	3 200	4 300	
114.300	44.450	44.450	34.925	3.5	3.3	172 000	205 000	3 600	4 800	
44.983	82.931	23.812	25.400	19.050	1.5	0.8	76 500	99 000	4 500	6 000
45.000	93.264	20.638	22.225	15.082	0.8	1.3	77 000	93 000	3 800	5 300
45.230	79.985	19.842	20.638	15.080	2.0	1.3	62 000	78 500	4 500	6 000
45.242	73.431	19.558	19.812	15.748	3.5	0.8	53 500	75 000	4 800	6 300
77.788	19.842	19.842	15.080	3.5	0.8	56 000	71 000	4 500	6 300	
77.788	21.430	19.842	16.667	3.5	0.8	56 000	71 000	4 500	6 300	
45.618	82.931	23.812	25.400	19.050	3.5	0.8	76 500	99 000	4 500	6 000
82.931	26.988	25.400	22.225	3.5	2.3	76 500	99 000	4 500	6 000	
46.000	75.000	18.000	18.000	14.000	2.3	1.5	51 000	71 500	4 500	6 300
46.038	79.375	17.462	17.462	13.495	2.8	1.5	46 000	57 000	4 500	6 000
80.962	19.050	17.462	14.288	0.8	1.5	45 000	57 000	4 300	6 000	
85.000	20.638	21.692	17.462	2.3	1.3	71 500	81 500	4 300	6 000	
85.000	25.400	25.608	20.638	3.5	1.3	79 500	105 000	4 300	6 000	
95.250	27.783	29.901	22.225	3.5	0.8	106 000	126 000	4 300	5 600	
88.900	20.638	22.225	16.513	3.5	1.3	73 000	85 000	4 000	5 600	
88.900	25.400	25.400	19.050	3.5	3.3	86 000	107 000	4 000	5 600	
95.250	30.162	29.370	23.020	3.5	3.3	106 000	143 000	3 800	5 300	
101.600	34.925	36.068	26.988	3.5	3.3	137 000	169 000	3 800	5 000	
111.125	30.162	26.909	20.638	3.5	3.3	92 500	110 000	3 200	4 300	
112.712	30.162	26.909	20.638	3.5	3.3	92 500	110 000	3 200	4 300	
117.475	33.338	31.750	23.812	3.5	3.3	137 000	156 000	3 200	4 300	
123.825	36.512	32.791	25.400	3.5	3.3	143 000	160 000	3 000	4 000	

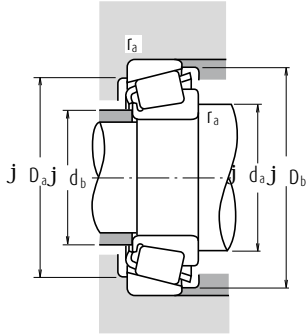

Dynamic Equivalent Load $P = X F_r + Y F_a$

$F_a/F_r \leq e$		$F_a/F_r > e$	
X	Y	X	Y
1	0	0.4	Y_1

Static Equivalent Load

$$P_0 = 0.5 F_r + Y_0 F_a$$

When $F_r > 0.5 F_r + Y_0 F_a$, use $P_0 = F_r$

The values of e , Y_1 and Y_0 are given in the table below.

Bearing Numbers		Abutment and Fillet Dimensions (mm)					Eff. Load Centers (mm)	Constant	Axial Load Factors		Mass (kg)		
CONE	CUP	d_a	d_b	D_a	D_b	Cone Cup r_a max.			a	e	Y_1	Y_0	CONE
HM 804843	HM 804810	63	57	81	91	3.5	3.3	26.1	0.55	1.1	0.60	0.677	0.354
53177	53375	63	53	81	89	3.5	0.8	30.7	0.74	0.81	0.45	0.572	0.365
53176	53375	59	53	81	89	1.3	0.8	30.7	0.74	0.81	0.45	0.574	0.365
53178	53375	60	53	81	89	2	0.8	30.7	0.74	0.81	0.45	0.574	0.365
HM 903247	HM 903210	61	54	81	91	1.3	0.8	31.5	0.74	0.81	0.45	0.651	0.389
HM 903249	HM 903210	65	54	81	91	3.5	0.8	31.5	0.74	0.81	0.45	0.635	0.389
53177	53387	63	53	82	91	3.5	0.8	30.7	0.74	0.81	0.45	0.568	0.442
5356	5335	58	56	89	97	1.3	3.3	27.0	0.30	2.0	1.1	1.23	0.637
HM 807040	HM 807010	66	59	89	100	3.5	3.3	29.7	0.49	1.2	0.68	1.14	0.502
460	453 A	60	54	97	100	3.5	0.8	20.7	0.34	1.8	0.98	0.93	0.42
55175	55437	67	60	92	105	3.5	3.3	37.3	0.88	0.68	0.37	0.867	0.514
65385	65320	65	59	97	107	3.5	3.3	32.2	0.43	1.4	0.77	1.39	0.894
25584	25520	53	51	74	77	1.5	0.8	17.6	0.33	1.8	0.99	0.354	0.203
376	374	54	54	85	88	0.8	1.3	17.1	0.34	1.8	0.97	0.492	0.174
17887	17831	57	52	68	74	2	1.3	15.9	0.37	1.6	0.90	0.274	0.136
LM 102949	LM 102910	56	50	68	70	3.5	0.8	14.6	0.31	2.0	1.1	0.213	0.102
LM 603049	LM 603011	57	50	71	74	3.5	0.8	17.2	0.43	1.4	0.77	0.249	0.119
LM 603049	LM 603012	57	50	70	74	3.5	0.8	18.8	0.43	1.4	0.77	0.249	0.137
25590	25520	58	51	74	77	3.5	0.8	17.6	0.33	1.8	0.99	0.343	0.203
25590	25523	58	51	72	77	3.5	2.3	20.8	0.33	1.8	0.99	0.343	0.248
* LM 503349	** LM 503310	55	51	67	71	2.3	1.5	15.9	0.40	1.5	0.82	0.209	0.096
18690	18620	56	51	71	74	2.8	1.5	15.5	0.37	1.6	0.88	0.211	0.126
13181	13318	52	52	72	76	0.8	1.5	20.1	0.53	1.1	0.63	0.236	0.144
359 S	354 A	55	51	77	80	2.3	1.3	15.4	0.31	2.0	1.1	0.343	0.162
2984	2924	58	52	76	80	3.5	1.3	19.0	0.35	1.7	0.95	0.397	0.223
436	432 A	59	52	84	87	3.5	0.8	18.6	0.28	2.1	1.2	0.536	0.381
369 A	362 A	60	53	81	84	3.5	1.3	16.6	0.32	1.9	1.0	0.381	0.166
M 804049	M 804010	63	56	77	85	3.5	3.3	23.8	0.55	1.1	0.60	0.455	0.218
HM 804846	HM 804810	66	57	81	91	3.5	3.3	26.1	0.55	1.1	0.60	0.626	0.354
528	522	62	55	89	95	3.5	3.3	22.1	0.29	2.1	1.2	0.894	0.416
55187	55437	69	62	92	105	3.5	3.3	37.3	0.88	0.68	0.37	0.817	0.514
55187	55443	69	62	92	106	3.5	3.3	37.3	0.88	0.68	0.37	0.816	0.554
66187	66462	66	62	100	111	3.5	3.3	32.1	0.63	0.96	0.53	1.19	0.552
72187	72487	72	66	102	116	3.5	3.3	37.0	0.74	0.81	0.45	1.29	0.79

Notes

- * The maximum bore diameter is listed and its tolerance is negative (See Table 7.4.1 on Page A136).
- ** The maximum outside diameter is listed and its tolerance is negative (See Table 7.4.2 on Pages A136 and A137).

Single-Row Tapered Roller Bearings (Inch Design)

Bore Diameter 48.412 – 52.388 mm

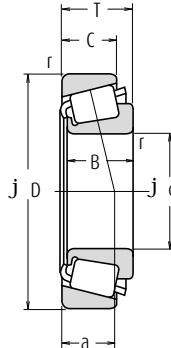

d	Boundary Dimensions (mm)				Cone		Basic Load Ratings (N)		Limiting Speeds (min ⁻¹)	
	D	T	B	C	r min.	C _r	C _{0r}	Grease	Oil	
48.412	95.250	30.162	29.370	23.020	3.5	3.3	106 000	143 000	3 800	5 300
	95.250	30.162	29.370	23.020	2.3	3.3	106 000	143 000	3 800	5 300
49.212	104.775	36.512	36.512	28.575	3.5	0.8	139 000	192 000	3 400	4 800
	114.300	44.450	44.450	36.068	3.5	3.3	196 000	243 000	3 400	4 800
50.000	82.000	21.500	21.500	17.000	3.0	0.5	71 000	96 000	4 300	5 600
	82.550	21.590	22.225	16.510	0.5	1.3	71 000	96 000	4 300	5 600
	88.900	20.638	22.225	16.513	2.3	1.3	73 000	85 000	4 000	5 600
	90.000	28.000	28.000	23.000	3.0	2.5	104 000	136 000	4 000	5 600
50.800	105.000	37.000	36.000	29.000	3.0	2.5	139 000	192 000	3 400	4 800
	80.962	18.258	18.258	14.288	1.5	1.5	53 000	81 000	4 300	5 600
	82.550	23.622	22.225	18.542	3.5	0.8	71 000	96 000	4 300	5 600
	82.931	21.590	22.225	16.510	3.5	1.3	71 000	96 000	4 300	5 600
	85.000	17.462	17.462	13.495	3.5	1.5	48 500	63 000	4 300	5 600
	85.725	19.050	18.263	12.700	1.5	1.5	42 500	54 000	4 000	5 300
	88.900	20.638	22.225	16.513	3.5	1.3	73 000	85 000	4 000	5 600
	88.900	20.638	22.225	16.513	1.5	1.3	73 000	85 000	4 000	5 600
	92.075	24.608	25.400	19.845	3.5	0.8	84 500	117 000	4 000	5 300
	93.264	30.162	30.302	23.812	0.8	0.8	103 000	136 000	3 800	5 300
	93.264	30.162	30.302	23.812	3.5	0.8	103 000	136 000	3 800	5 300
	95.250	27.783	28.575	22.225	3.5	2.3	110 000	144 000	3 800	5 300
101.600	31.750	31.750	25.400	3.5	3.3	118 000	150 000	3 600	5 000	
101.600	34.925	36.068	26.988	0.8	3.3	137 000	169 000	3 800	5 000	
101.600	34.925	36.068	26.988	3.5	3.3	137 000	169 000	3 800	5 000	
104.775	36.512	36.512	28.575	3.5	0.8	139 000	192 000	3 400	4 800	
104.775	36.512	36.512	28.575	3.5	3.3	139 000	192 000	3 400	4 800	
108.966	34.925	36.512	26.988	3.5	3.3	145 000	181 000	3 600	4 800	
111.125	30.162	26.909	20.638	3.5	3.3	113 000	152 000	3 000	4 300	
111.125	30.162	26.909	20.638	3.5	3.3	92 500	110 000	3 200	4 300	
123.825	36.512	32.791	25.400	3.5	3.3	162 000	199 000	2 800	4 000	
123.825	36.512	32.791	25.400	3.5	3.3	143 000	160 000	3 000	4 000	
127.000	44.450	44.450	34.925	3.5	3.3	199 000	258 000	3 000	4 000	
127.000	50.800	52.388	41.275	3.5	3.3	236 000	300 000	3 200	4 300	
52.388	92.075	24.608	25.400	19.845	3.5	0.8	84 500	117 000	4 000	5 300
	100.000	25.000	22.225	21.824	2.3	2.0	77 000	93 000	3 800	5 300
	111.125	30.162	26.909	20.638	3.5	3.3	92 500	110 000	3 200	4 300

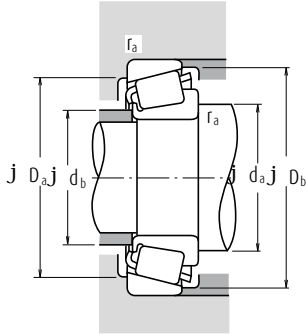

Dynamic Equivalent Load $P = X F_r + Y F_a$

$F_a/F_r \leq e$		$F_a/F_r > e$	
X	Y	X	Y
1	0	0.4	Y_1

Static Equivalent Load

$$P_0 = 0.5 F_r + Y_0 F_a$$

When $F_r > 0.5 F_r + Y_0 F_a$, use $P_0 = F_r$

The values of e , Y_1 and Y_0 are given in the table below.

Bearing Numbers		Abutment and Fillet Dimensions (mm)					Eff. Load Centers (mm)	Constant	Axial Load Factors		Mass (kg)		
CONE	CUP	d_a	d_b	D_a	D_b	Cone Cup r_a max.			a	e	Y_1	Y_0	CONE
HM 804849	HM 804810	66	57	81	91	3.5	3.3	26.1	0.55	1.1	0.60	0.61	0.354
HM 804848	HM 804810	63	57	81	91	2.3	3.3	26.1	0.55	1.1	0.60	0.614	0.354
HM 807044	HM 807011	69	63	91	100	3.5	0.8	29.7	0.49	1.2	0.68	1.03	0.508
HH 506348	HH 506310	71	61	97	107	3.5	3.3	30.8	0.40	1.5	0.82	1.43	0.837
▲ JLM 104948	▲ JLM 104910	60	55	76	78	3	0.5	16.1	0.31	2.0	1.1	0.306	0.129
* LM 104947 A	LM 104911	55	55	75	78	0.5	1.3	15.7	0.31	2.0	1.1	0.316	0.133
366	362 A	59	55	81	84	2.3	1.3	16.6	0.32	1.9	1.0	0.351	0.166
▲ JM 205149	▲ JM 205110	62	57	80	85	3	2.5	19.9	0.33	1.8	1.0	0.507	0.246
▲ JHM 807045	▲ JHM 807012	69	63	90	100	3	2.5	29.7	0.49	1.2	0.68	1.01	0.523
L 305649	L 305610	58	56	73	77	1.5	1.5	15.7	0.36	1.7	0.93	0.239	0.119
LM 104949	LM 104911 A	62	55	75	78	3.5	0.8	17.8	0.31	2.0	1.1	0.303	0.156
LM 104949	LM 104912	62	55	75	78	3.5	1.3	15.7	0.31	2.0	1.1	0.301	0.14
18790	18720	62	56	77	80	3.5	1.5	16.7	0.41	1.5	0.81	0.239	0.136
18200	18337	59	56	76	81	1.5	1.5	21.0	0.57	1.1	0.58	0.268	0.136
368 A	362 A	62	56	81	84	3.5	1.3	16.6	0.32	1.9	1.0	0.338	0.166
368	362 A	58	56	81	84	1.5	1.3	16.6	0.32	1.9	1.0	0.341	0.166
28580	28521	63	57	83	87	3.5	0.8	20.0	0.38	1.6	0.87	0.46	0.247
3775	3730	58	58	84	88	0.8	0.8	22.4	0.34	1.8	0.97	0.568	0.297
3780	3730	64	58	84	88	3.5	0.8	22.4	0.34	1.8	0.97	0.564	0.297
33889	33821	64	58	85	90	3.5	2.3	19.8	0.33	1.8	1.0	0.601	0.267
49585	49520	66	59	88	96	3.5	3.3	23.4	0.40	1.5	0.82	0.744	0.389
529	522	59	58	89	95	0.8	3.3	22.1	0.29	2.1	1.2	0.822	0.416
529 X	522	65	58	89	95	3.5	3.3	22.1	0.29	2.1	1.2	0.819	0.416
HM 807046	HM 807011	70	63	91	100	3.5	0.8	29.7	0.49	1.2	0.68	0.992	0.508
HM 807046	HM 807010	70	63	89	100	3.5	3.3	29.7	0.49	1.2	0.68	0.993	0.502
59200	59429	68	61	93	101	3.5	3.3	25.4	0.40	1.5	0.82	0.943	0.594
55200 C	55437	71	65	92	105	3.5	3.3	37.6	0.88	0.68	0.37	0.845	0.514
55200	55437	71	64	92	105	3.5	3.3	37.3	0.88	0.68	0.37	0.767	0.514
72200 C	72487	77	67	102	116	3.5	3.3	38.0	0.74	0.81	0.45	1.33	0.79
72200	72487	74	66	102	116	3.5	3.3	37.0	0.74	0.81	0.45	1.22	0.79
65200	65500	75	69	107	119	3.5	3.3	35.0	0.49	1.2	0.68	1.86	1.03
6279	6220	71	65	108	117	3.5	3.3	30.7	0.30	2.0	1.1	2.08	1.22
28584	28521	65	58	83	87	3.5	0.8	20.0	0.38	1.6	0.87	0.435	0.247
377	372	62	58	86	90	2.3	2	21.4	0.34	1.8	0.97	0.392	0.435
55206	55437	72	64	92	105	3.5	3.3	37.3	0.88	0.68	0.37	0.737	0.514

Notes * The maximum bore diameter is listed and its tolerance is negative (See Table 7.4.1 on Page A136).

▲ The tolerances are listed in Tables 2, 3 and 4 on Pages B202 and B203.

Single-Row Tapered Roller Bearings (Inch Design)

Bore Diameter 53.975 – 58.738 mm

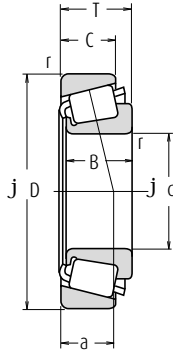

Boundary Dimensions (mm)					Cone		Cup		Basic Load Ratings (N)		Limiting Speeds (min ⁻¹)		
d	D	T	B	C	r	r	C _r	C _{0r}	Grease	Oil			
53.975	104.775	39.688	40.157	33.338	3.5	3.3	148 000	207 000	3 600	4 800			
	107.950	36.512	36.957	28.575	3.5	3.3	144 000	182 000	3 600	4 800			
	122.238	33.338	31.750	23.812	3.5	3.3	135 000	156 000	3 000	4 000			
	123.825	36.512	32.791	25.400	3.5	3.3	143 000	160 000	3 000	4 000			
	123.825	36.512	32.791	25.400	3.5	3.3	162 000	199 000	2 800	4 000			
	123.825	38.100	36.678	30.162	3.5	3.3	161 000	221 000	3 000	4 000			
	127.000	44.450	44.450	34.925	3.5	3.3	199 000	258 000	3 000	4 000			
	127.000	50.800	52.388	41.275	3.5	3.3	236 000	300 000	3 200	4 300			
	130.175	36.512	33.338	23.812	3.5	3.3	133 000	154 000	2 600	3 600			
	55.000	90.000	23.000	23.000	18.500	1.5	0.5	79 000	111 000	3 800	5 300		
95.000		29.000	29.000	23.500	1.5	2.5	111 000	152 000	3 800	5 000			
96.838		21.000	21.946	15.875	2.3	0.8	80 500	100 000	3 600	5 000			
110.000		39.000	39.000	32.000	3.0	2.5	177 000	225 000	3 400	4 500			
115.000		41.021	41.275	31.496	3.0	3.0	172 000	214 000	3 200	4 500			
55.562	97.630	24.608	24.608	19.446	3.5	0.8	89 000	129 000	3 600	5 000			
	122.238	43.658	43.764	36.512	1.3	3.3	198 000	292 000	3 000	4 000			
	123.825	36.512	32.791	25.400	3.5	3.3	143 000	160 000	3 000	4 000			
	123.825	36.512	32.791	25.400	3.5	3.3	162 000	199 000	2 800	4 000			
	57.150	96.838	21.000	21.946	15.875	3.5	0.8	80 500	100 000	3 600	5 000		
96.838		21.000	21.946	15.875	2.3	0.8	80 500	100 000	3 600	5 000			
96.838		25.400	21.946	20.275	3.5	2.3	80 500	100 000	3 600	5 000			
98.425		21.000	21.946	17.826	3.5	0.8	80 500	100 000	3 600	5 000			
104.775		30.162	29.317	24.605	3.5	3.3	116 000	149 000	3 400	4 800			
104.775		30.162	29.317	24.605	2.3	3.3	116 000	149 000	3 400	4 800			
104.775		30.162	30.958	23.812	0.8	3.3	130 000	170 000	3 400	4 800			
104.775		30.162	30.958	23.812	0.8	0.8	130 000	170 000	3 400	4 800			
122.238		33.338	31.750	23.812	3.5	3.3	135 000	156 000	3 000	4 000			
123.825		36.512	32.791	25.400	3.5	3.3	162 000	199 000	2 800	4 000			
57.531	123.825	38.100	36.678	30.162	3.5	3.3	161 000	221 000	3 000	4 000			
	140.030	36.512	33.236	23.520	3.5	2.3	152 000	183 000	2 600	3 600			
	144.983	36.000	33.236	23.007	3.5	3.5	152 000	183 000	2 600	3 600			
	149.225	53.975	54.229	44.450	3.5	3.3	287 000	410 000	2 600	3 400			
	96.838	21.000	21.946	15.875	3.5	0.8	80 500	100 000	3 600	5 000			
	58.738	112.712	33.338	30.048	26.988	3.5	3.3	120 000	173 000	3 200	4 300		

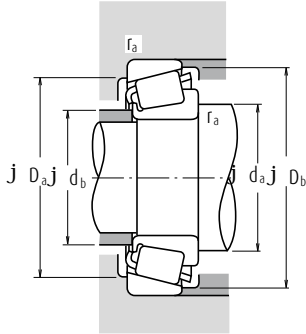

Dynamic Equivalent Load $P = X F_r + Y F_a$

$F_a/F_r \leq e$		$F_a/F_r > e$	
X	Y	X	Y
1	0	0.4	Y_1

Static Equivalent Load

$$P_0 = 0.5 F_r + Y_0 F_a$$

When $F_r > 0.5 F_r + Y_0 F_a$, use $P_0 = F_r$

The values of e , Y_1 and Y_0 are given in the table below.

Bearing Numbers		Abutment and Fillet Dimensions (mm)						Eff. Load Centers (mm)	Constant	Axial Load Factors		Mass (kg)	
CONE	CUP	d_a	d_b	D_a	D_b	Cone r_a max.	Cup			Y_1	Y_0	CONE	CUP
4595	4535	70	63	90	99	3.5	3.3	27.4	0.34	1.79	0.98	0.989	0.589
539	532 X	68	61	94	100	3.5	3.3	24.3	0.30	2.0	1.1	0.88	0.57
66584	66520	75	68	105	116	3.5	3.3	34.3	0.67	0.90	0.50	1.2	0.558
72212	72487	77	66	102	116	3.5	3.3	37.0	0.74	0.81	0.45	1.16	0.79
72212 C	72487	79	67	102	116	3.5	3.3	38.0	0.74	0.81	0.45	1.27	0.79
557 S	552 A	71	65	109	116	3.5	3.3	28.8	0.35	1.7	0.95	1.49	0.764
65212	65500	77	71	107	119	3.5	3.3	35.0	0.49	1.2	0.68	1.76	1.03
6280	6220	74	67	108	117	3.5	3.3	30.7	0.30	2.0	1.1	1.97	1.22
HM911242	HM911210	79	74	109	124	3.5	3.3	42.2	0.82	0.73	0.40	1.45	0.725
▲ JLM506849	▲ JLM506810	63	61	82	86	1.5	0.5	19.7	0.40	1.5	0.82	0.378	0.186
▲ JM207049	▲ JM207010	64	62	85	91	1.5	2.5	21.3	0.33	1.8	0.99	0.59	0.26
385	382 A	65	61	89	92	2.3	0.8	17.6	0.35	1.7	0.93	0.455	0.179
▲ JH307749	▲ JH307710	71	64	97	104	3	2.5	27.2	0.35	1.7	0.95	1.13	0.567
622 X	614 X	70	64	101	108	3	3	26.6	0.31	1.9	1.1	1.3	0.597
28680	28622	68	62	88	92	3.5	0.8	21.3	0.40	1.5	0.82	0.499	0.27
5566	5535	70	68	106	116	1.3	3.3	29.9	0.36	1.7	0.92	1.76	0.815
72218	72487	78	66	102	116	3.5	3.3	37.0	0.74	0.81	0.45	1.12	0.79
72218 C	72487	80	67	102	116	3.5	3.3	38.0	0.74	0.81	0.45	1.23	0.79
387 A	382 A	69	62	89	92	3.5	0.8	17.6	0.35	1.7	0.93	0.42	0.179
387	382 A	66	62	89	92	2.3	0.8	17.6	0.35	1.7	0.93	0.423	0.179
387 A	382 S	69	62	87	91	3.5	2.3	22.0	0.35	1.7	0.93	0.42	0.249
387 A	382	69	62	90	92	3.5	0.8	17.6	0.35	1.7	0.93	0.42	0.226
469	453 X	70	63	92	98	3.5	3.3	23.1	0.34	1.8	0.98	0.692	0.376
462	453 X	67	63	92	98	2.3	3.3	23.1	0.34	1.8	0.98	0.694	0.376
45289	45220	65	65	93	99	0.8	3.3	21.9	0.33	1.8	0.99	0.752	0.347
45289	45221	65	65	95	99	0.8	0.8	21.9	0.33	1.8	0.99	0.76	0.35
66587	66520	77	71	105	116	3.5	3.3	34.3	0.67	0.90	0.50	1.14	0.558
72225 C	72487	81	67	102	116	3.5	3.3	38.0	0.74	0.81	0.45	1.19	0.79
555 S	552 A	83	68	109	116	3.5	3.3	28.8	0.35	1.7	0.95	1.41	0.764
78225	78511	83	77	117	132	3.5	2.3	44.2	0.87	0.69	0.38	1.67	0.926
78225	78571	83	77	118	132	3.5	3.5	43.6	0.87	0.69	0.38	1.68	1.08
6455	6420	81	75	129	140	3.5	3.3	39.0	0.36	1.7	0.91	3.49	1.63
388 A	382 A	69	63	89	92	3.5	0.8	17.6	0.35	1.7	0.93	0.416	0.179
3981	3926	73	67	98	106	3.5	3.3	28.7	0.40	1.5	0.82	0.899	0.541

Note ▲ The tolerances are listed in Tables 2, 3 and 4 on Pages B202 and B203.

Single-Row Tapered Roller Bearings (Inch Design)

Bore Diameter 60.000 – 64.963 mm

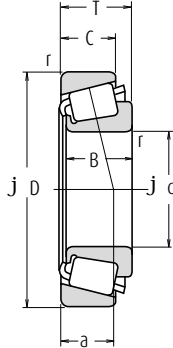

Boundary Dimensions (mm)					Basic Load Ratings (N)		Limiting Speeds (min ⁻¹)			
d	D	T	B	C	Cone	Cup	C _r	C _{0r}	Grease	Oil
					r min.	r min.				
60.000	95.000	24.000	24.000	19.000	5.0	2.5	86 500	125 000	3 600	5 000
	104.775	21.433	22.000	15.875	2.3	2.0	83 500	107 000	3 400	4 500
	110.000	22.000	21.996	18.824	0.8	1.3	85 500	113 000	3 200	4 300
	122.238	33.338	31.750	23.812	3.5	3.3	135 000	156 000	3 000	4 000
60.325	100.000	25.400	25.400	19.845	3.5	3.3	91 000	135 000	3 400	4 800
	101.600	25.400	25.400	19.845	3.5	3.3	91 000	135 000	3 400	4 800
	122.238	38.100	36.678	30.162	2.3	3.3	161 000	221 000	3 000	4 000
	122.238	38.100	38.354	29.718	8.0	1.5	188 000	245 000	3 000	4 000
	122.238	43.658	43.764	36.512	0.8	3.3	198 000	292 000	3 000	4 000
	127.000	44.450	44.450	34.925	3.5	3.3	199 000	258 000	3 000	4 000
	130.175	41.275	41.275	31.750	3.5	3.3	195 000	263 000	2 800	3 800
	135.755	53.975	56.007	44.450	3.5	3.3	264 000	355 000	2 800	3 800
61.912	136.525	46.038	46.038	36.512	3.5	3.3	233 000	370 000	2 600	3 400
	146.050	41.275	39.688	25.400	3.5	3.3	193 000	225 000	2 400	3 400
	152.400	47.625	46.038	31.750	3.5	3.3	237 000	267 000	2 400	3 400
63.500	94.458	19.050	19.050	15.083	1.5	1.5	59 000	100 000	3 600	4 800
	104.775	21.433	22.000	15.875	2.0	2.0	83 500	107 000	3 400	4 500
	107.950	25.400	25.400	19.050	1.5	3.3	90 000	138 000	3 200	4 300
	110.000	22.000	21.996	18.824	3.5	1.3	85 500	113 000	3 200	4 300
	110.000	22.000	21.996	18.824	1.5	1.3	85 500	113 000	3 200	4 300
	112.712	30.162	30.048	23.812	3.5	3.2	120 000	173 000	3 200	4 300
	112.712	30.162	30.162	23.812	3.5	3.3	142 000	202 000	3 200	4 300
	112.712	33.338	30.048	26.988	3.5	3.3	120 000	173 000	3 200	4 300
	122.238	38.100	38.354	29.718	7.0	3.3	188 000	245 000	3 000	4 000
	122.238	38.100	38.354	29.718	7.0	1.5	188 000	245 000	3 000	4 000
	122.238	38.100	38.354	29.718	3.5	1.5	188 000	245 000	3 000	4 000
	122.238	43.658	43.764	36.512	3.5	3.3	198 000	292 000	3 000	4 000
	123.825	38.100	36.678	30.162	3.5	3.3	161 000	221 000	3 000	4 000
	127.000	36.512	36.170	28.575	3.5	3.3	166 000	234 000	2 800	3 800
	130.175	41.275	41.275	31.750	3.5	3.3	195 000	263 000	2 800	3 800
	136.525	36.512	33.236	23.520	2.3	3.3	152 000	183 000	2 600	3 600
136.525	41.275	41.275	31.750	3.5	3.3	195 000	263 000	2 800	3 800	
140.030	36.512	33.236	23.520	2.3	2.3	152 000	183 000	2 600	3 600	
64.963	127.000	36.512	36.170	28.575	3.5	3.3	166 000	234 000	2 800	3 800

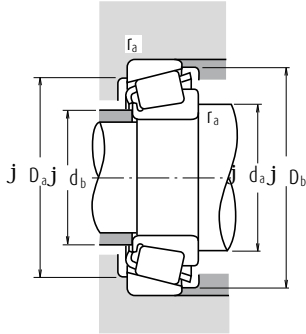

Dynamic Equivalent Load $P = X F_r + Y F_a$

$F_a/F_r \leq e$		$F_a/F_r > e$	
X	Y	X	Y
1	0	0.4	Y_1

Static Equivalent Load

$$P_0 = 0.5 F_r + Y_0 F_a$$

When $F_r > 0.5 F_r + Y_0 F_a$, use $P_0 = F_r$

The values of e , Y_1 and Y_0 are given in the table below.

Bearing Numbers		Abutment and Fillet Dimensions (mm)					Cone	Cup	Eff. Load Centers (mm)	Constant	Axial Load Factors		Mass (kg)	
CONE	CUP	d_a	d_b	D_a	D_b	r_a max.					a	e	Y_1	Y_0
▲ JLM 508748	▲ JLM 508710	75	66	85	91	5	2.5	21.6	0.40	1.5	0.82	0.43	0.20	
* 39236	39412	71	67	96	100	2.3	2	20.0	0.39	1.5	0.85	0.559	0.186	
397	394 A	69	68	101	104	0.8	1.3	20.9	0.40	1.5	0.82	0.642	0.263	
66585	66520	79	73	105	116	3.5	3.3	34.3	0.67	0.90	0.50	1.07	0.558	
28985	28921	73	67	89	96	3.5	3.3	22.9	0.43	1.4	0.78	0.538	0.232	
28985	28920	73	67	90	97	3.5	3.3	22.9	0.43	1.4	0.78	0.538	0.272	
558	553 X	73	69	108	115	2.3	3.3	28.8	0.35	1.7	0.95	1.33	0.692	
HM 212044	HM 212010	85	70	110	116	8	1.5	27.0	0.34	1.8	0.98	1.43	0.604	
5582	5535	73	72	106	116	0.8	3.3	29.9	0.36	1.7	0.92	1.61	0.815	
65237	65500	82	71	107	119	3.5	3.3	35.0	0.49	1.2	0.68	1.56	1.03	
637	633	78	72	116	124	3.5	3.3	29.9	0.36	1.7	0.91	1.87	0.712	
6376	6320	81	74	117	126	3.5	3.3	35.0	0.32	1.8	1.0	2.45	1.39	
H 715334	H 715311	84	78	119	132	3.5	3.3	37.1	0.47	1.3	0.70	2.51	0.961	
H 913842	H 913810	90	82	124	138	3.5	3.3	44.4	0.78	0.77	0.42	2.2	0.898	
9180	9121	90	81	130	145	3.5	3.3	44.3	0.66	0.92	0.50	2.77	1.21	
L 610549	L 610510	71	69	86	91	1.5	1.5	19.6	0.42	1.4	0.78	0.306	0.154	
39250	39412	73	69	96	100	2	2	20.0	0.39	1.5	0.85	0.501	0.186	
29586	29520	73	71	96	103	1.5	3.3	24.0	0.46	1.3	0.72	0.661	0.281	
395	394 A	77	70	101	104	3.5	1.3	20.9	0.40	1.5	0.82	0.58	0.263	
390 A	394 A	73	70	101	104	1.5	1.3	20.9	0.40	1.5	0.82	0.583	0.263	
3982	3920	77	71	99	106	3.5	3.2	25.5	0.40	1.5	0.82	0.789	0.454	
39585	39520	77	71	101	107	3.5	3.3	23.5	0.34	1.8	0.97	0.899	0.359	
3982	3926	78	71	98	106	3.5	3.3	28.7	0.40	1.5	0.82	0.789	0.541	
HM 212047	HM 212011	87	73	108	116	7	3.3	26.9	0.34	1.8	0.98	1.34	0.598	
HM 212047	HM 212010	87	73	110	116	7	1.5	26.9	0.34	1.8	0.98	1.34	0.604	
HM 212046	HM 212010	80	73	110	116	3.5	1.5	26.9	0.34	1.8	0.98	1.35	0.604	
5584	5535	81	75	106	116	3.5	3.3	29.9	0.36	1.7	0.92	1.5	0.815	
559	522 A	78	73	109	116	3.5	3.3	28.8	0.35	1.7	0.95	1.23	0.764	
565	563	80	73	112	120	3.5	3.3	28.3	0.36	1.6	0.91	1.46	0.655	
639	633	81	74	116	124	3.5	3.3	29.9	0.36	1.7	0.91	1.77	0.712	
78250	78537	85	79	115	130	2.3	3.3	44.2	0.87	0.69	0.38	1.51	0.782	
639	632	79	76	119	125	3.5	3.3	29.9	0.36	1.7	0.91	1.77	1.04	
78250	78551	85	79	117	132	2.3	2.3	44.2	0.87	0.69	0.38	1.51	0.926	
569	563	81	74	112	120	3.5	3.3	28.3	0.36	1.6	0.91	1.41	0.655	

Notes * The maximum bore diameter is listed and its tolerance is negative (See Table 7.4.1 on Page A136).

▲ The tolerances are listed in Tables 2, 3 and 4 on Pages B202 and B203.

Single-Row Tapered Roller Bearings (Inch Design)

Bore Diameter 65.000 – 69.850 mm

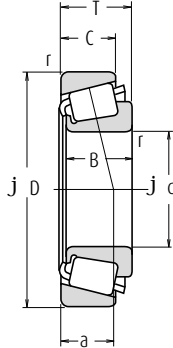

d	Boundary Dimensions (mm)					Cone		Basic Load Ratings (N)		Limiting Speeds (min ⁻¹)	
	D	T	B	C	r min.	C _r	C _{0r}	Grease	Oil		
65.000	105.000	24.000	23.000	18.500	3.0	93 000	126 000	3 400	4 500		
	110.000	28.000	28.000	22.500	3.0	120 000	173 000	3 200	4 300		
	120.000	29.002	29.007	23.444	2.3	123 000	169 000	3 000	4 000		
	120.000	39.000	38.500	32.000	3.0	185 000	249 000	3 000	4 000		
65.088	135.755	53.975	56.007	44.450	3.5	264 000	355 000	2 800	3 800		
	136.525	46.038	46.038	36.512	3.5	233 000	370 000	2 600	3 400		
66.675	110.000	22.000	21.996	18.824	0.8	85 500	113 000	3 200	4 300		
	110.000	22.000	21.996	18.824	3.5	85 500	113 000	3 200	4 300		
	112.712	30.162	30.048	23.812	3.5	120 000	173 000	3 200	4 300		
	112.712	30.162	30.048	23.812	5.5	120 000	173 000	3 200	4 300		
	112.712	30.162	30.162	23.812	3.5	142 000	202 000	3 200	4 300		
	112.712	30.162	30.162	23.812	3.5	142 000	202 000	3 200	4 300		
	117.475	30.162	30.162	23.812	3.5	119 000	179 000	3 000	4 000		
	122.238	38.100	36.678	30.162	3.5	161 000	221 000	3 000	4 000		
	122.238	38.100	38.354	29.718	3.5	188 000	245 000	3 000	4 000		
	122.238	38.100	38.354	29.718	3.5	188 000	245 000	3 000	4 000		
68.262	123.825	38.100	36.678	30.162	3.5	161 000	221 000	3 000	4 000		
	136.525	46.038	46.038	36.512	3.5	233 000	370 000	2 600	3 400		
	110.000	22.000	21.996	18.824	2.3	85 500	113 000	3 200	4 300		
	120.000	29.795	29.007	24.237	3.5	123 000	169 000	3 000	4 000		
	122.238	38.100	36.678	30.162	3.5	161 000	221 000	3 000	4 000		
	127.000	36.512	36.170	28.575	3.5	166 000	234 000	2 800	3 800		
	136.525	41.275	41.275	31.750	3.5	229 000	297 000	2 600	3 600		
	136.525	46.038	46.038	36.512	3.5	233 000	370 000	2 600	3 400		
	152.400	47.625	46.038	31.750	3.5	237 000	267 000	2 400	3 400		
	69.850	112.712	22.225	21.996	15.875	1.5	85 000	113 000	3 000	4 000	
112.712		25.400	25.400	19.050	1.5	96 000	152 000	2 800	4 000		
117.475		30.162	30.162	23.812	3.5	119 000	179 000	3 000	4 000		
120.000		32.545	32.545	26.195	3.5	152 000	225 000	3 000	4 000		
120.650		25.400	25.400	19.050	1.5	96 000	152 000	2 800	4 000		
127.000		36.512	36.170	28.575	3.5	166 000	234 000	2 800	3 800		
130.175		41.275	41.275	31.750	3.5	195 000	263 000	2 800	3 800		
146.050		41.275	39.688	25.400	3.5	193 000	225 000	2 400	3 400		
146.050		41.275	41.275	31.750	3.5	207 000	296 000	2 400	3 200		
149.225		53.975	54.229	44.450	5.0	271 000	385 000	2 600	3 400		
150.089	44.450	46.672	36.512	3.5	265 000	370 000	2 400	3 200			

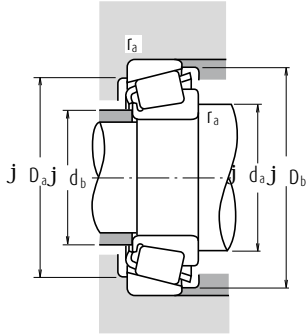

Dynamic Equivalent Load $P = X F_r + Y F_a$

$F_a/F_r \leq e$		$F_a/F_r > e$	
X	Y	X	Y
1	0	0.4	Y_1

Static Equivalent Load

$$P_0 = 0.5 F_r + Y_0 F_a$$

When $F_r > 0.5 F_r + Y_0 F_a$, use $P_0 = F_r$

The values of e , Y_1 and Y_0 are given in the table below.

Bearing Numbers		Abutment and Fillet Dimensions (mm)					Cone	Cup	Eff. Load Centers (mm)	Constant	Axial Load Factors		Mass (kg)	
CONE	CUP	d_a	d_b	D_a	D_b	r_a max.					a	e	Y_1	Y_0
▲ JLM 710949	▲ JLM 710910	77	71	96	101	3	1	23.7	0.45	1.3	0.73	0.526	0.237	
▲ JM 511946	▲ JM 511910	78	72	99	105	3	2.5	24.5	0.40	1.5	0.82	0.72	0.342	
478	472 A	77	73	106	114	2.3	3.3	24.3	0.38	1.6	0.86	0.942	0.466	
▲ JH 211749	▲ JH 211710	80	74	107	114	3	2.5	27.9	0.34	1.8	0.98	1.25	0.625	
6379	6320	84	77	117	126	3.5	3.3	35.0	0.32	1.8	1.0	2.25	1.39	
H 715340	H 715311	88	82	118	132	3.5	3.3	37.1	0.47	1.3	0.70	2.4	0.961	
395 A	394 A	73	73	101	104	0.8	1.3	20.9	0.40	1.5	0.82	0.528	0.263	
395 S	394 A	79	73	101	104	3.5	1.3	20.9	0.40	1.5	0.82	0.524	0.263	
3984	3920	80	74	99	106	3.5	3.2	25.5	0.40	1.5	0.82	0.712	0.454	
3994	3920	84	74	99	106	5.5	3.2	25.5	0.40	1.5	0.82	0.706	0.454	
39590	39521	80	74	103	107	3.5	0.8	23.5	0.34	1.8	0.97	0.822	0.365	
39590	39520	80	74	101	107	3.5	3.3	23.5	0.34	1.8	0.97	0.822	0.359	
33262	33462	81	75	104	112	3.5	3.3	26.8	0.44	1.4	0.76	0.911	0.442	
560	553 X	81	75	108	115	3.5	3.3	28.8	0.35	1.7	0.95	1.14	0.692	
HM 212049	HM 212010	82	75	110	116	3.5	1.5	26.9	0.34	1.8	0.98	1.25	0.604	
HM 212049	HM 212011	81	74	108	116	3.5	3.3	26.9	0.34	1.8	0.98	1.25	0.598	
560	552 A	81	75	109	116	3.5	3.3	28.8	0.35	1.7	0.95	1.14	0.764	
H 715341	H 715311	89	83	118	132	3.5	3.3	37.1	0.47	1.3	0.70	2.34	0.961	
399 A	394 A	78	74	101	104	2.3	1.3	20.9	0.40	1.5	0.82	0.497	0.263	
480	472	83	76	106	113	3.5	2	25.1	0.38	1.6	0.86	0.862	0.493	
560 S	553 X	83	76	108	115	3.5	3.3	28.8	0.35	1.7	0.95	1.09	0.692	
570	563	83	77	112	120	3.5	3.3	28.3	0.36	1.6	0.91	1.32	0.655	
H 414245	H 414210	86	82	121	129	3.5	3.3	30.6	0.36	1.7	0.92	1.95	0.796	
H 715343	H 715311	90	84	118	132	3.5	3.3	37.1	0.47	1.3	0.70	2.28	0.961	
9185	9121	94	81	130	145	3.5	3.3	44.3	0.66	0.92	0.50	2.53	1.21	
LM 613449	LM 613410	78	76	104	107	1.5	0.8	22.1	0.42	1.4	0.79	0.562	0.238	
29675	29620	80	77	101	109	1.5	3.3	26.3	0.49	1.2	0.68	0.695	0.273	
33275	33462	84	77	104	112	3.5	3.3	26.8	0.44	1.4	0.76	0.83	0.442	
47487	47420	84	78	107	114	3.5	3.3	26.0	0.36	1.7	0.92	1.02	0.477	
29675	29630	79	78	105	113	1.5	3.3	26.3	0.49	1.2	0.68	0.695	0.489	
566	563 X	85	78	114	120	3.5	0.8	28.3	0.36	1.6	0.91	1.27	0.658	
643	633	86	80	116	124	3.5	3.3	29.9	0.36	1.7	0.91	1.56	0.712	
H 913849	H 913810	95	82	124	138	3.5	3.3	44.4	0.78	0.77	0.42	1.95	0.898	
655	653	88	82	131	139	3.5	3.3	33.2	0.41	1.5	0.81	2.35	0.891	
6454	6420	94	85	129	140	5	3.3	39.0	0.36	1.7	0.91	2.80	1.67	
745 A	742	88	82	134	142	3.5	3.3	32.5	0.33	1.8	1.0	2.82	1.07	

Note ▲ The tolerances are listed in Tables 2, 3 and 4 on Pages B202 and B203.

Single-Row Tapered Roller Bearings (Inch Design)

Bore Diameter 70.000 – 76.200 mm

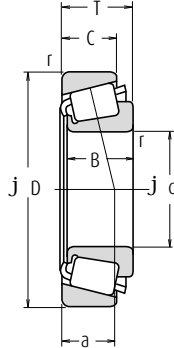

d	Boundary Dimensions (mm)				Cone		Cup		Basic Load Ratings (N)		Limiting Speeds (min ⁻¹)	
	D	T	B	C	r min.	r	C _r	C _{0r}	Grease	Oil		
70.000	110.000	26.000	25.000	20.500	1.0	2.5	98 500	152 000	3 000	4 000		
	115.000	29.000	29.000	23.000	3.0	2.5	126 000	177 000	3 000	4 000		
	120.000	29.795	29.007	24.237	2.0	2.0	123 000	169 000	3 000	4 000		
71.438	117.475	30.162	30.162	23.812	3.5	3.3	119 000	179 000	3 000	4 000		
	120.000	32.545	32.545	26.195	3.5	3.3	152 000	225 000	3 000	4 000		
	127.000	36.512	36.170	28.575	6.4	3.3	166 000	234 000	2 800	3 800		
	127.000	36.512	36.170	28.575	3.5	3.3	166 000	234 000	2 800	3 800		
	130.175	41.275	41.275	31.750	6.4	3.3	195 000	263 000	2 800	3 800		
	136.525	41.275	41.275	31.750	3.5	3.3	195 000	263 000	2 800	3 800		
	136.525	41.275	41.275	31.750	3.5	3.3	229 000	297 000	2 600	3 600		
73.025	136.525	46.038	46.038	36.512	3.5	3.3	233 000	370 000	2 600	3 400		
	112.712	25.400	25.400	19.050	3.5	3.3	96 000	152 000	2 800	4 000		
	117.475	30.162	30.162	23.812	3.5	3.3	119 000	179 000	3 000	4 000		
	127.000	36.512	36.170	28.575	3.5	3.3	166 000	234 000	2 800	3 800		
	146.050	41.275	41.275	31.750	3.5	3.3	207 000	296 000	2 400	3 200		
	149.225	53.975	54.229	44.450	3.5	3.3	287 000	410 000	2 600	3 400		
73.817	127.000	36.512	36.170	28.575	0.8	3.3	166 000	234 000	2 800	3 800		
74.612	150.000	41.275	41.275	31.750	3.5	3.0	207 000	296 000	2 400	3 200		
75.000	115.000	25.000	25.000	19.000	3.0	2.5	101 000	150 000	3 000	4 000		
	120.000	31.000	29.500	25.000	3.0	2.5	129 000	198 000	2 800	3 800		
	145.000	51.000	51.000	42.000	3.0	2.5	283 000	410 000	2 600	3 400		
76.200	121.442	24.608	23.012	17.462	2.0	2.0	89 000	124 000	2 800	3 800		
	127.000	30.162	31.000	22.225	3.5	3.3	134 000	195 000	2 800	3 800		
	127.000	30.162	31.001	22.225	6.4	3.3	134 000	195 000	2 800	3 800		
	133.350	33.338	33.338	26.195	0.8	3.3	154 000	237 000	2 600	3 600		
	135.733	44.450	46.101	34.925	3.5	3.3	216 000	340 000	2 600	3 600		
	136.525	30.162	29.769	22.225	3.5	3.3	130 000	192 000	2 600	3 400		
	136.525	30.162	29.769	22.225	6.4	3.3	130 000	192 000	2 600	3 400		
	139.992	36.512	36.098	28.575	3.5	3.3	175 000	260 000	2 600	3 400		
	149.225	53.975	54.229	44.450	3.5	3.3	287 000	410 000	2 600	3 400		
	152.400	39.688	36.322	30.162	3.5	3.2	183 000	285 000	2 200	3 200		
	152.400	41.275	41.275	31.750	3.5	3.3	207 000	296 000	2 400	3 200		
	161.925	49.212	46.038	31.750	3.5	3.3	248 000	290 000	2 200	3 000		
	161.925	53.975	55.100	42.862	3.5	3.3	325 000	480 000	2 200	3 000		
	161.925	53.975	55.100	42.862	6.4	3.3	325 000	480 000	2 200	3 000		
	161.925	53.975	55.100	42.862	6.4	0.8	325 000	480 000	2 200	3 000		

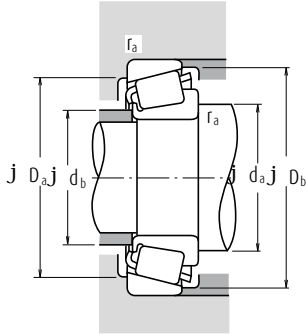

Dynamic Equivalent Load $P = X F_r + Y F_a$

$F_a/F_r \leq e$		$F_a/F_r > e$	
X	Y	X	Y
1	0	0.4	Y_1

Static Equivalent Load

$$P_0 = 0.5 F_r + Y_0 F_a$$

When $F_r > 0.5 F_r + Y_0 F_a$, use $P_0 = F_r$

The values of e , Y_1 and Y_0 are given in the table below.

Bearing Numbers		Abutment and Fillet Dimensions (mm)					Cone	Cup	Eff. Load Centers (mm)	Constant	Axial Load Factors		Mass (kg)	
CONE	CUP	d_a	d_b	D_a	D_b	r_a max.					a	e	Y_1	Y_0
▲ JLM 813049	▲ JLM 813010	78	77	98	105	1	2.5	26.2	0.49	1.2	0.68	0.604	0.304	
▲ JM 612949	▲ JM 612910	83	77	103	110	3	2.5	26.4	0.43	1.4	0.77	0.800	0.362	
484	472	80	78	106	113	2	2	25.1	0.38	1.6	0.86	0.822	0.493	
33281	33462	85	79	104	112	3.5	3.3	26.8	0.44	1.4	0.76	0.789	0.442	
47490	47420	86	79	107	114	3.5	3.3	26.0	0.36	1.7	0.92	0.983	0.477	
567 S	563	92	80	112	120	6.4	3.3	28.3	0.36	1.6	0.91	1.21	0.655	
567 A	563	86	80	112	120	3.5	3.3	28.3	0.36	1.6	0.91	1.23	0.655	
645	633	93	81	116	124	6.4	3.3	29.9	0.36	1.7	0.91	1.49	0.712	
644	632	87	81	118	125	3.5	3.3	29.9	0.36	1.7	0.91	1.5	1.04	
H 414249	H 414210	89	83	121	129	3.5	3.3	30.6	0.36	1.7	0.92	1.83	0.796	
H 715345	H 715311	92	84	119	132	3.5	3.3	37.1	0.47	1.3	0.70	2.15	0.961	
29685	29620	86	80	101	109	3.5	3.3	26.3	0.49	1.2	0.68	0.62	0.273	
33287	33462	87	80	104	112	3.5	3.3	26.8	0.44	1.4	0.76	0.746	0.442	
567	563	88	81	112	120	3.5	3.3	28.3	0.36	1.6	0.91	1.17	0.655	
657	653	91	85	131	139	3.5	3.3	33.2	0.41	1.5	0.81	2.24	0.891	
6460	6420	93	87	129	140	3.5	3.3	39.0	0.36	1.7	0.91	2.8	1.63	
568	563	83	82	112	120	0.8	3.3	28.3	0.36	1.6	0.91	1.15	0.655	
658	653 X	92	86	133	141	3.5	3	33.2	0.41	1.5	0.81	2.37	0.932	
▲ JLM 714149	▲ JLM 714110	87	81	104	110	3	2.5	25.3	0.46	1.3	0.72	0.638	0.272	
▲ JM 714249	▲ JM 714210	88	83	108	115	3	2.5	28.8	0.44	1.4	0.74	0.863	0.436	
▲ JH 415647	▲ JH 415610	94	89	129	139	3	2.5	36.7	0.36	1.7	0.91	2.64	1.19	
34300	34478	86	84	111	116	2	2	26.3	0.45	1.3	0.73	0.65	0.316	
42687	42620	90	84	114	121	3.5	3.3	27.3	0.42	1.4	0.79	1.03	0.438	
42688	42620	94	84	114	121	6.4	3.3	27.3	0.42	1.4	0.79	1.01	0.438	
47680	47620	86	85	119	128	0.8	3.3	29.0	0.40	1.5	0.82	1.39	0.577	
5760	5735	94	88	119	130	3.5	3.3	32.9	0.41	1.5	0.81	1.86	0.887	
495 A	493	92	86	122	130	3.5	3.3	28.7	0.44	1.4	0.74	1.27	0.55	
495 AX	493	98	86	122	130	6.4	3.3	28.7	0.44	1.4	0.74	1.26	0.55	
575	572	92	86	125	133	3.5	3.3	31.1	0.40	1.5	0.82	1.61	0.788	
6461	6420	96	89	129	140	3.5	3.3	39.0	0.36	1.7	0.91	2.64	1.63	
590 A	592 A	95	89	135	145	3.5	3.2	37.1	0.44	1.4	0.75	2.2	1.06	
659	652	93	87	134	141	3.5	3.3	33.2	0.41	1.5	0.81	2.11	1.26	
9285	9220	103	90	138	153	3.5	3.3	49.8	0.71	0.85	0.47	2.82	1.4	
6576	6535	99	92	141	154	3.5	3.3	40.7	0.40	1.5	0.82	3.74	1.67	
6575	6535	104	92	141	154	6.4	3.3	40.7	0.40	1.5	0.82	3.73	1.67	
6575	6536	104	92	144	154	6.4	0.8	40.7	0.40	1.5	0.82	3.73	1.68	

Note ▲ The tolerances are listed in Tables 2, 3 and 4 on Pages B202 and B203.

Single-Row Tapered Roller Bearings (Inch Design)

Bore Diameter 76.200 – 83.345 mm

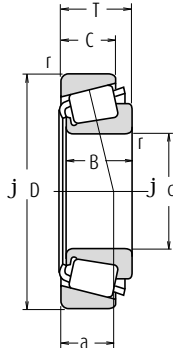

Boundary Dimensions (mm)					Basic Load Ratings (N)		Limiting Speeds (min ⁻¹)				
d	D	T	B	C	Cone	Cup	C _r	C _{0r}	Grease	Oil	
					r min.	r					
76.200	168.275	53.975	56.363	41.275	6.4	3.3	345 000	470 000	2 200	3 000	
	168.275	53.975	56.363	41.275	0.8	3.3	345 000	470 000	2 200	3 000	
	171.450	49.212	46.038	31.750	3.5	3.3	257 000	310 000	2 000	2 800	
77.788	177.800	55.562	50.800	34.925	3.5	3.3	257 000	310 000	2 000	2 800	
	121.442	24.608	23.012	17.462	3.5	2.0	89 000	124 000	2 800	3 800	
	127.000	30.162	31.000	22.225	3.5	3.3	134 000	195 000	2 800	3 800	
79.375	135.733	44.450	46.101	34.925	3.5	3.3	216 000	340 000	2 600	3 600	
	146.050	41.275	41.275	31.750	3.5	3.3	207 000	296 000	2 400	3 200	
	150.089	44.450	46.672	36.512	3.5	3.3	265 000	370 000	2 400	3 200	
80.000	130.000	35.000	34.000	28.500	3.0	2.5	166 000	251 000	2 600	3 600	
	80.962	136.525	30.162	29.769	22.225	3.5	3.3	130 000	192 000	2 600	3 400
82.550	139.700	36.512	36.098	28.575	3.5	3.3	175 000	260 000	2 600	3 400	
	139.992	36.512	36.098	28.575	3.5	3.3	175 000	260 000	2 600	3 400	
	125.412	25.400	25.400	19.845	3.5	1.5	102 000	164 000	2 600	3 600	
	133.350	30.162	29.769	22.225	3.5	3.3	130 000	192 000	2 600	3 400	
	133.350	33.338	33.338	26.195	3.5	3.3	154 000	237 000	2 600	3 600	
	133.350	33.338	33.338	26.195	0.8	3.3	154 000	237 000	2 600	3 600	
	133.350	33.338	33.338	26.195	6.8	3.3	154 000	237 000	2 600	3 600	
	133.350	39.688	39.688	32.545	6.8	3.3	179 000	310 000	2 600	3 600	
	136.525	30.162	29.769	22.225	3.5	3.3	130 000	192 000	2 600	3 400	
	139.700	36.512	36.098	28.575	3.5	3.3	175 000	260 000	2 600	3 400	
	139.992	36.512	36.098	28.575	3.5	3.3	175 000	260 000	2 600	3 400	
	139.992	36.512	36.098	28.575	6.8	3.3	175 000	260 000	2 600	3 400	
83.345	146.050	41.275	41.275	31.750	3.5	3.3	207 000	296 000	2 400	3 200	
	150.000	44.455	46.672	35.000	3.5	3.3	265 000	370 000	2 400	3 200	
	150.089	44.450	46.672	36.512	3.5	3.3	265 000	370 000	2 400	3 200	
	152.400	41.275	41.275	31.750	3.5	3.3	207 000	296 000	2 400	3 200	
	161.925	47.625	48.260	38.100	3.5	3.3	274 000	390 000	2 200	3 000	
	161.925	53.975	55.100	42.862	3.5	3.3	325 000	480 000	2 200	3 000	
	168.275	47.625	48.260	38.100	3.5	3.3	274 000	390 000	2 200	3 000	
	168.275	53.975	56.363	41.275	3.5	3.3	345 000	470 000	2 200	3 000	
	83.345	125.412	25.400	25.400	19.845	3.5	1.5	102 000	164 000	2 600	3 600
	125.412	25.400	25.400	19.845	0.8	1.5	102 000	164 000	2 600	3 600	

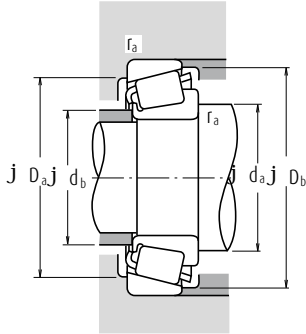

Dynamic Equivalent Load $P = X F_r + Y F_a$

$F_a/F_r \leq e$		$F_a/F_r > e$	
X	Y	X	Y
1	0	0.4	Y_1

Static Equivalent Load

$$P_0 = 0.5 F_r + Y_0 F_a$$

When $F_r > 0.5 F_r + Y_0 F_a$, use $P_0 = F_r$

The values of e , Y_1 and Y_0 are given in the table below.

Bearing Numbers		Abutment and Fillet Dimensions (mm)						Eff. Load Centers (mm)	Constant	Axial Load Factors		Mass (kg)	
CONE	CUP	d_a	d_b	D_a	D_b	Cone r_a max.	Cup			e	Y_1	Y_0	CONE
843	832	101	89	149	155	6.4	3.3	35.2	0.30	2.0	1.1	4.11	1.74
837	832	90	89	149	155	0.8	3.3	35.2	0.30	2.0	1.1	4.13	1.74
9380	9321	105	98	147	164	3.5	3.3	54.1	0.76	0.79	0.43	3.47	1.51
9378	9320	105	98	148	164	3.5	3.3	57.3	0.76	0.79	0.43	3.71	2.24
34306	34478	90	84	110	116	3.5	2	26.3	0.45	1.3	0.73	0.612	0.316
42690	42620	91	85	114	121	3.5	3.3	27.3	0.42	1.4	0.79	0.976	0.438
5795	5735	96	89	119	130	3.5	3.3	32.9	0.41	1.5	0.81	1.79	0.887
661	653	96	90	131	139	3.5	3.3	33.2	0.41	1.5	0.81	1.99	0.891
750	742	96	90	134	142	3.5	3.3	32.5	0.33	1.8	1.0	2.42	1.07
▲ JM 515649	▲ JM 515610	94	88	117	125	3	2.5	29.9	0.39	1.5	0.85	1.18	0.583
496	493	95	89	122	130	3.5	3.3	28.7	0.44	1.4	0.74	1.13	0.55
581	572 X	96	90	125	133	3.5	3.3	31.1	0.40	1.5	0.82	1.44	0.774
581	572	96	90	125	133	3.5	3.3	31.1	0.40	1.5	0.82	1.44	0.788
27687	27620	96	89	115	120	3.5	1.5	25.7	0.42	1.4	0.79	0.747	0.348
495	492 A	97	90	120	128	3.5	3.3	28.7	0.44	1.4	0.74	1.08	0.434
47686	47620	97	90	119	128	3.5	3.3	29.0	0.40	1.5	0.82	1.18	0.577
47685	47620	90	90	119	128	0.8	3.3	29.0	0.40	1.5	0.82	1.18	0.577
47687	47620	103	90	119	128	6.8	3.3	29.0	0.40	1.5	0.82	1.16	0.577
HM 516448	HM 516410	105	92	118	128	6.8	3.3	32.4	0.40	1.5	0.82	1.35	0.767
495	493	97	90	122	130	3.5	3.3	28.7	0.44	1.4	0.74	1.08	0.55
580	572 X	98	91	125	133	3.5	3.3	31.1	0.40	1.5	0.82	1.39	0.774
580	572	98	91	125	133	3.5	3.3	31.1	0.40	1.5	0.82	1.39	0.788
582	572	104	91	125	133	6.8	3.3	31.1	0.40	1.5	0.82	1.37	0.788
663	653	99	92	131	139	3.5	3.3	33.2	0.41	1.5	0.81	1.85	0.891
749 A	743	99	93	134	142	3.5	3.3	32.5	0.33	1.8	1.0	2.26	1.04
749 A	742	98	93	135	143	3.5	3.3	32.5	0.33	1.8	1.0	2.26	1.07
663	652	99	92	134	141	3.5	3.3	33.2	0.41	1.5	0.81	1.85	1.26
757	752	100	94	144	150	3.5	3.3	35.6	0.34	1.8	0.97	2.79	1.61
6559	6535	104	98	141	154	3.5	3.3	40.7	0.40	1.5	0.82	3.4	1.67
757	753	100	94	147	150	3.5	3.3	35.6	0.34	1.8	0.97	2.79	2.1
842	832	101	94	149	155	3.5	3.3	35.2	0.30	2.0	1.1	3.76	1.74
27690	27620	96	90	115	120	3.5	1.5	25.7	0.42	1.4	0.79	0.727	0.348
27689	27620	90	90	115	120	0.8	1.5	25.7	0.42	1.4	0.79	0.732	0.348

Note ▲ The tolerances are listed in Tables 2, 3 and 4 on Pages B202 and B203.

Single-Row Tapered Roller Bearings (Inch Design)

Bore Diameter 84.138 – 90.488 mm

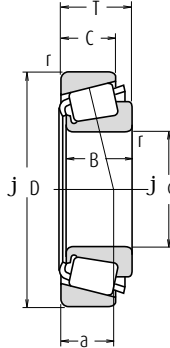

Boundary Dimensions (mm)					Basic Load Ratings (N)		Limiting Speeds (min ⁻¹)			
d	D	T	B	C	Cone	Cup	C _r	C _{0r}	Grease	Oil
					r min.	r min.				
84.138	136.525	30.162	29.769	22.225	3.5	3.3	130 000	192 000	2 600	3 400
	146.050	41.275	41.275	31.750	3.5	3.3	207 000	296 000	2 400	3 200
	171.450	49.212	46.038	31.750	3.5	3.3	257 000	310 000	2 000	2 800
85.000	130.000	30.000	29.000	24.000	6.0	2.5	138 000	222 000	2 600	3 600
	130.000	30.000	29.000	24.000	3.0	2.5	138 000	222 000	2 600	3 600
	140.000	39.000	38.000	31.500	3.0	2.5	202 000	305 000	2 400	3 400
85.026	150.000	46.000	46.000	38.000	3.0	2.5	275 000	390 000	2 400	3 200
	150.089	44.450	46.672	36.512	3.5	3.3	265 000	370 000	2 400	3 200
	150.089	44.450	46.672	36.512	5.0	3.3	265 000	370 000	2 400	3 200
85.725	133.350	30.162	29.769	22.225	3.5	3.3	130 000	192 000	2 600	3 400
	136.525	30.162	29.769	22.225	3.5	3.3	130 000	192 000	2 600	3 400
	142.138	42.862	42.862	34.133	4.8	3.3	221 000	360 000	2 400	3 400
	146.050	41.275	41.275	31.750	6.4	3.3	207 000	296 000	2 400	3 200
	146.050	41.275	41.275	31.750	3.5	3.3	207 000	296 000	2 400	3 200
	152.400	39.688	36.322	30.162	3.5	3.2	183 000	285 000	2 200	3 200
87.312	161.925	47.625	48.260	38.100	3.5	3.3	274 000	390 000	2 200	3 000
	168.275	41.275	41.275	30.162	3.5	3.3	223 000	345 000	2 000	2 800
	190.500	57.150	57.531	46.038	8.0	3.3	390 000	520 000	1 900	2 600
	149.225	31.750	28.971	24.608	3.0	3.3	140 000	218 000	2 200	3 000
	152.400	39.688	36.322	30.162	3.5	3.2	183 000	285 000	2 200	3 200
	152.400	39.688	39.688	30.162	6.4	3.3	253 000	365 000	2 200	3 200
88.900	161.925	47.625	48.260	38.100	3.5	3.3	274 000	390 000	2 200	3 000
	161.925	47.625	48.260	38.100	7.0	3.3	274 000	390 000	2 200	3 000
	161.925	53.975	55.100	42.862	3.5	3.3	325 000	480 000	2 200	3 000
	168.275	47.625	48.260	38.100	3.5	3.3	274 000	390 000	2 200	3 000
	168.275	53.975	56.363	41.275	3.5	3.3	345 000	470 000	2 200	3 000
	190.500	57.150	57.531	44.450	8.0	3.3	355 000	500 000	1 900	2 600
	190.500	57.150	57.531	46.038	8.0	3.3	390 000	520 000	1 900	2 600
	145.000	35.000	34.000	27.000	3.0	2.5	190 000	285 000	2 400	3 200
	147.000	40.000	40.000	32.500	7.0	3.5	229 000	345 000	2 400	3 200
155.000	44.000	44.000	35.500	3.0	2.5	274 000	390 000	2 200	3 000	
90.488	161.925	47.625	48.260	38.100	3.5	3.3	274 000	390 000	2 200	3 000

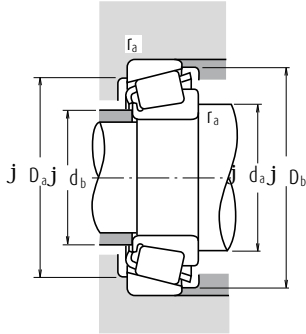

Dynamic Equivalent Load $P = X F_r + Y F_a$

$F_a/F_r \leq e$		$F_a/F_r > e$	
X	Y	X	Y
1	0	0.4	Y_1

Static Equivalent Load

$$P_0 = 0.5 F_r + Y_0 F_a$$

When $F_r > 0.5 F_r + Y_0 F_a$, use $P_0 = F_r$

The values of e , Y_1 and Y_0 are given in the table below.

Bearing Numbers		Abutment and Fillet Dimensions (mm)					Eff. Load Centers (mm)	Constant	Axial Load Factors		Mass (kg)		
CONE	CUP	d_a	d_b	D_a	D_b	Cone Cup r_a max.			a	e	Y_1	Y_0	CONE
498	493	98	91	122	130	3.5	3.3	28.7	0.44	1.4	0.74	1.04	0.55
664	653	99	93	131	139	3.5	3.3	33.2	0.41	1.5	0.81	1.79	0.891
9385	9321	111	98	147	164	3.5	3.3	54.1	0.76	0.79	0.43	3.11	1.51
▲ JM 716648	▲ JM 716610	104	92	117	125	6	2.5	29.5	0.44	1.4	0.74	0.931	0.461
▲ JM 716649	▲ JM 716610	98	92	117	125	3	2.5	29.5	0.44	1.4	0.74	0.943	0.461
▲ JHM 516849	▲ JHM 516810	100	94	125	134	3	2.5	33.3	0.41	1.5	0.81	1.55	0.768
▲ JH 217249	▲ JH 217210	101	95	134	142	3	2.5	33.9	0.33	1.8	0.99	2.29	1.09
749	742	101	95	134	142	3.5	3.3	32.5	0.33	1.8	1.0	2.14	1.07
749 S	742	104	95	134	142	5	3.3	32.5	0.33	1.8	1.0	2.14	1.07
497	492 A	99	93	120	128	3.5	3.3	28.7	0.44	1.4	0.74	0.987	0.434
497	493	99	93	122	130	3.5	3.3	28.7	0.44	1.4	0.74	0.987	0.55
HM 617049	HM 617010	106	95	125	137	4.8	3.3	35.4	0.43	1.4	0.76	1.77	0.911
665 A	653	107	95	131	139	6.4	3.3	33.2	0.41	1.5	0.81	1.71	0.891
665	653	102	95	131	139	3.5	3.3	33.2	0.41	1.5	0.81	1.72	0.891
596	592 A	102	96	135	144	3.5	3.2	37.1	0.44	1.4	0.75	1.85	1.06
758	752	103	97	144	150	3.5	3.3	35.6	0.34	1.8	0.97	2.63	1.61
677	672	105	99	149	160	3.5	3.3	38.3	0.47	1.3	0.70	2.91	1.24
HH 221432	HH 221410	118	103	171	179	8	3.3	42.3	0.33	1.8	0.99	5.51	2.24
42350	42587	104	98	134	143	3	3.3	34.9	0.49	1.2	0.67	1.39	0.711
593	592 A	104	98	135	144	3.5	3.2	37.1	0.44	1.4	0.75	1.73	1.06
HM 518445	HM 518410	107	96	137	148	6.4	3.3	33.1	0.40	1.5	0.82	2.11	0.776
759	752	106	99	144	150	3.5	3.3	35.6	0.34	1.8	0.97	2.47	1.61
766	752	113	99	144	150	7	3.3	35.6	0.34	1.8	0.97	2.45	1.61
6580	6535	109	102	141	154	3.5	3.3	40.7	0.40	1.5	0.82	3.03	1.67
759	753	106	99	147	150	3.5	3.3	35.6	0.34	1.8	0.97	2.47	2.1
850	832	106	100	149	155	3.5	3.3	35.2	0.30	2.0	1.1	3.39	1.74
855	854	118	103	170	174	8	3.3	41.8	0.33	1.8	0.99	4.99	2.55
HH 221434	HH 221410	120	105	171	179	8	3.3	42.3	0.33	1.8	0.99	5.41	2.24
▲ JM 718149	▲ JM 718110	105	99	131	139	3	2.5	33.0	0.44	1.4	0.74	1.49	0.66
* HM 218248	** HM 218210	111	98	133	141	7	3.5	30.8	0.33	1.8	0.99	1.77	0.796
▲ JHM 318448	▲ JHM 318410	106	100	140	148	3	2.5	34.1	0.34	1.7	0.96	2.32	1.01
760	752	107	101	144	150	3.5	3.3	35.6	0.34	1.8	0.97	2.38	1.61

Notes

- * The maximum bore diameter is listed and its tolerance is negative (See Table 7.4.1 on Page A136).
- ** The maximum outside diameter is listed and its tolerance is negative (See Table 7.4.2 on Pages A136 and A137).
- ▲ The tolerances are listed in Tables 2, 3 and 4 on Pages B202 and B203.

Single-Row Tapered Roller Bearings (Inch Design)

Bore Diameter 92.075 – 100.012 mm

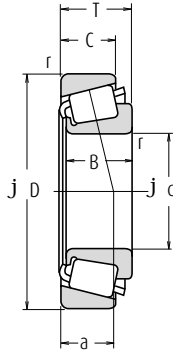

d	Boundary Dimensions (mm)				Cone		Cup		Basic Load Ratings (N)		Limiting Speeds (min ⁻¹)	
	D	T	B	C	r min.	r	C _r	C _{0r}	Grease	Oil		
92.075	146.050	33.338	34.925	26.195	3.5	3.3	169 000	280 000	2 400	3 200		
	148.430	28.575	28.971	21.433	3.5	3.0	140 000	218 000	2 200	3 000		
	152.400	39.688	36.322	30.162	3.5	3.2	183 000	285 000	2 200	3 200		
	152.400	39.688	36.322	30.162	6.4	3.2	183 000	285 000	2 200	3 200		
	168.275	41.275	41.275	30.162	3.5	3.3	223 000	345 000	2 000	2 800		
93.662	190.500	57.150	57.531	44.450	8.0	3.3	355 000	500 000	1 900	2 600		
	148.430	28.575	28.971	21.433	3.0	3.0	140 000	218 000	2 200	3 000		
	149.225	31.750	28.971	24.608	3.0	3.3	140 000	218 000	2 200	3 000		
	152.400	39.688	36.322	30.162	3.5	3.2	183 000	285 000	2 200	3 200		
	152.400	39.688	36.322	33.338	3.5	3.3	183 000	285 000	2 200	3 200		
95.000	150.000	35.000	34.000	27.000	3.0	2.5	183 000	285 000	2 200	3 200		
	146.050	33.338	34.925	26.195	3.5	3.3	169 000	280 000	2 400	3 200		
	148.430	28.575	28.971	21.433	3.0	3.0	140 000	218 000	2 200	3 000		
	149.225	31.750	28.971	24.608	3.5	3.3	140 000	218 000	2 200	3 000		
	152.400	39.688	36.322	30.162	3.5	3.2	183 000	285 000	2 200	3 200		
95.250	152.400	39.688	36.322	33.338	3.5	3.3	183 000	285 000	2 200	3 200		
	168.275	41.275	41.275	30.162	3.5	3.3	223 000	345 000	2 000	2 800		
	171.450	47.625	48.260	38.100	3.5	3.3	282 000	415 000	2 000	2 800		
	180.975	47.625	48.006	38.100	3.5	3.3	258 000	375 000	2 000	2 600		
	190.500	57.150	57.531	44.450	8.0	3.3	355 000	500 000	1 900	2 600		
	190.500	57.150	57.531	46.038	8.0	3.3	390 000	520 000	1 900	2 600		
	148.430	28.575	28.971	21.433	3.5	3.0	140 000	218 000	2 200	3 000		
	149.225	31.750	28.971	24.606	3.5	3.3	140 000	218 000	2 200	3 000		
	161.925	36.512	36.116	26.195	3.5	3.3	191 000	310 000	2 000	2 800		
	168.275	41.275	41.275	30.162	3.5	3.3	223 000	345 000	2 000	2 800		
98.425	180.975	47.625	48.006	38.100	3.5	3.3	258 000	375 000	2 000	2 600		
	190.500	57.150	57.531	44.450	3.5	3.3	355 000	500 000	1 900	2 600		
	190.500	57.150	57.531	46.038	3.5	3.3	390 000	520 000	1 900	2 600		
	190.500	57.150	57.531	46.038	6.4	3.3	390 000	520 000	1 900	2 600		
	190.500	57.150	57.531	46.038	2.3	2.3	146 000	235 000	2 200	3 000		
100.000	155.000	36.000	35.000	28.000	3.0	2.5	191 000	325 000	2 000	2 800		
	160.000	41.000	40.000	32.000	3.0	2.5	239 000	380 000	2 000	2 800		
	160.000	41.000	40.000	32.000	3.0	2.5	239 000	380 000	2 000	2 800		
100.012	157.162	36.512	36.116	26.195	3.5	3.3	191 000	310 000	2 000	2 800		

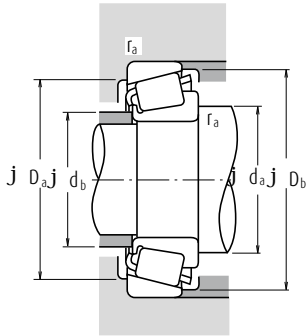

Dynamic Equivalent Load $P = X F_r + Y F_a$

$F_a/F_r \leq e$		$F_a/F_r > e$	
X	Y	X	Y
1	0	0.4	Y_1

Static Equivalent Load

$$P_0 = 0.5 F_r + Y_0 F_a$$

When $F_r > 0.5 F_r + Y_0 F_a$, use $P_0 = F_r$

The values of e , Y_1 and Y_0 are given in the table below.

Bearing Numbers		Abutment and Fillet Dimensions (mm)					Cone	Cup	Eff. Load Centers (mm)	Constant	Axial Load Factors		Mass (kg)	
CONE	CUP	d_a	d_b	D_a	D_b	r_a max.					a	e	Y_1	Y_0
47890	47820	107	101	131	140	3.5	3.3	32.3	0.45	1.3	0.74	1.46	0.664	
42362	42584	107	101	134	142	3.5	3	31.8	0.49	1.2	0.67	1.29	0.553	
598	592 A	107	101	135	144	3.5	3.2	37.1	0.44	1.4	0.75	1.6	1.06	
598 A	592 A	113	101	135	144	6.4	3.2	37.1	0.44	1.4	0.75	1.59	1.06	
681	672	110	104	149	160	3.5	3.3	38.3	0.47	1.3	0.70	2.62	1.24	
857	854	121	106	170	174	8	3.3	41.8	0.33	1.8	0.99	4.78	2.55	
42368	42584	107	102	134	142	3	3	31.8	0.49	1.2	0.67	1.24	0.553	
42368	42587	107	102	134	143	3	3.3	34.9	0.49	1.2	0.67	1.24	0.711	
597	592 A	109	102	135	144	3.5	3.2	37.1	0.44	1.4	0.75	1.54	1.06	
▲ JM 719149	▲ JM 719113	109	104	135	143	3	2.5	33.4	0.44	1.4	0.75	1.46	0.765	
47896	47820	110	103	131	140	3.5	3.3	32.3	0.45	1.3	0.74	1.33	0.664	
42375	42584	108	103	134	142	3	3	31.8	0.49	1.2	0.67	1.18	0.553	
42376	42587	109	103	134	143	3.5	3.3	34.9	0.49	1.2	0.67	1.18	0.711	
594	592 A	110	104	135	144	3.5	3.2	37.1	0.44	1.4	0.75	1.47	1.06	
594	592	109	103	135	145	3.5	3.3	37.1	0.44	1.4	0.75	1.47	1.12	
683	672	113	106	149	160	3.5	3.3	38.3	0.47	1.3	0.70	2.47	1.24	
77375	77675	117	105	152	159	3.5	3.3	37.8	0.37	1.6	0.90	2.91	1.67	
776	772	114	107	161	168	3.5	3.3	39.1	0.39	1.6	0.86	3.25	1.99	
864	854	123	108	170	174	8	3.3	41.8	0.33	1.8	0.99	4.57	2.55	
HH 221440	HH 221410	125	110	171	179	8	3.3	42.3	0.33	1.8	0.99	5.0	2.24	
42381	42584	110	104	134	142	3.5	3	31.8	0.49	1.2	0.67	1.13	0.553	
42381	42587	111	105	135	143	3.5	3.3	34.9	0.49	1.2	0.67	1.13	0.711	
52387	52637	114	108	144	154	3.5	3.3	36.1	0.47	1.3	0.69	1.89	0.942	
685	672	116	109	149	160	3.5	3.3	38.3	0.47	1.3	0.70	2.32	1.24	
779	772	116	110	161	168	3.5	3.3	39.1	0.39	1.6	0.86	3.06	1.99	
866	854	118	111	170	174	3.5	3.3	41.8	0.33	1.8	0.99	4.38	2.55	
HH 221442	HH 221410	119	113	171	179	3.5	3.3	42.3	0.33	1.8	0.99	4.81	2.24	
HH 221447	HH 221410	126	114	171	179	6.4	3.3	42.3	0.33	1.8	0.99	4.68	2.24	
▲ JLM 820048	▲ JLM 820012	111	107	135	144	2.3	2.3	36.8	0.50	1.2	0.66	1.27	0.616	
▲ JM 720249	▲ JM 720210	115	109	140	149	3	2.5	36.8	0.47	1.3	0.70	1.68	0.772	
▲ JHM 720249	▲ JHM 720210	117	109	143	154	3	2.5	38.2	0.47	1.3	0.70	2.09	0.974	
52393	52618	116	109	142	152	3.5	3.3	36.1	0.47	1.3	0.69	1.81	0.702	

Note ▲ The tolerances are listed in Tables 2, 3 and 4 on Pages B202 and B203.

Single-Row Tapered Roller Bearings (Inch Design)

Bore Diameter 101.600 – 117.475 mm

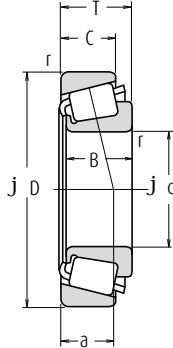

Boundary Dimensions (mm)					Cone		Cup		Basic Load Ratings (N)		Limiting Speeds (min ⁻¹)	
d	D	T	B	C	r	r	C _r	C _{0r}	Grease	Oil		
101.600	157.162	36.512	36.116	26.195	3.5	3.3	191 000	310 000	2 000	2 800		
	161.925	36.512	36.116	26.195	3.5	3.3	191 000	310 000	2 000	2 800		
	168.275	41.275	41.275	30.162	3.5	3.3	223 000	345 000	2 000	2 800		
	180.975	47.625	48.006	38.100	3.5	3.3	258 000	375 000	2 000	2 600		
190.500	57.150	57.531	44.450	8.0	3.3	3.3	355 000	500 000	1 900	2 600		
	57.150	57.531	46.038	8.0	3.3	3.3	390 000	520 000	1 900	2 600		
	212.725	66.675	66.675	53.975	7.0	3.3	570 000	810 000	1 700	2 200		
	180.975	47.625	48.006	38.100	7.0	3.3	258 000	375 000	2 000	2 600		
104.775	180.975	47.625	48.006	38.100	3.5	3.3	258 000	375 000	2 000	2 600		
	190.500	47.625	49.212	34.925	3.5	3.3	296 000	465 000	1 800	2 400		
106.362	165.100	36.512	36.512	26.988	3.5	3.3	195 000	320 000	2 000	2 600		
	107.950	158.750	23.020	21.438	15.875	3.5	3.3	102 000	165 000	2 000	2 800	
159.987	34.925	34.925	26.988	3.5	3.3	3.3	164 000	315 000	2 000	2 800		
	161.925	34.925	34.925	26.988	3.5	3.3	164 000	280 000	2 000	2 800		
	165.100	36.512	36.512	26.988	3.5	3.3	195 000	320 000	2 000	2 600		
	190.500	47.625	49.212	34.925	3.5	3.3	296 000	465 000	1 800	2 400		
212.725	66.675	66.675	53.975	8.0	3.3	3.3	570 000	810 000	1 700	2 200		
	159.987	34.925	34.925	26.988	3.5	3.3	164 000	315 000	2 000	2 800		
159.987	34.925	34.925	26.988	8.0	3.3	3.3	164 000	315 000	2 000	2 800		
	109.992	177.800	41.275	41.275	30.162	3.5	3.3	232 000	375 000	1 800	2 600	
110.000	165.000	35.000	35.000	26.500	3.0	2.5	195 000	320 000	2 000	2 600		
	180.000	47.000	46.000	38.000	3.0	2.5	310 000	490 000	1 900	2 600		
111.125	190.500	47.625	49.212	34.925	3.5	3.3	296 000	465 000	1 800	2 400		
	114.300	152.400	21.433	21.433	16.670	1.5	1.5	89 500	178 000	2 000	2 800	
177.800	41.275	41.275	30.162	3.5	3.3	3.3	232 000	375 000	1 800	2 600		
	180.000	34.925	31.750	25.400	3.5	0.8	174 000	254 000	1 800	2 400		
	190.500	47.625	49.212	34.925	3.5	3.3	296 000	465 000	1 800	2 400		
	212.725	66.675	66.675	53.975	7.0	3.3	475 000	700 000	1 700	2 400		
212.725	66.675	66.675	53.975	7.0	3.3	3.3	570 000	810 000	1 700	2 200		
	115.087	190.500	47.625	49.212	34.925	3.5	3.3	296 000	465 000	1 800	2 400	
117.475	180.975	34.925	31.750	25.400	3.5	3.3	174 000	254 000	1 800	2 400		

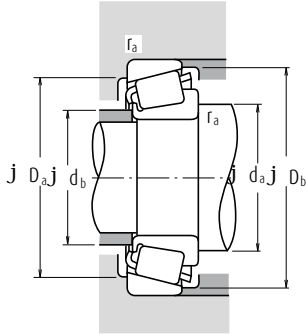

Dynamic Equivalent Load $P = X F_r + Y F_a$

$F_a/F_r \leq e$		$F_a/F_r > e$	
X	Y	X	Y
1	0	0.4	Y_1

Static Equivalent Load

$$P_0 = 0.5 F_r + Y_0 F_a$$

When $F_r > 0.5 F_r + Y_0 F_a$, use $P_0 = F_r$

The values of e , Y_1 and Y_0 are given in the table below.

Bearing Numbers		Abutment and Fillet Dimensions (mm)						Eff. Load Centers (mm)	Constant	Axial Load Factors		Mass (kg)	
CONE	CUP	d_a	d_b	D_a	D_b	Cone r_a max.	Cup			Y_1	Y_0	CONE	CUP
52400	52618	117	111	142	152	3.5	3.3	36.1	0.47	1.3	0.69	1.75	0.702
52400	52637	117	111	144	154	3.5	3.3	36.1	0.47	1.3	0.69	1.75	0.942
687	672	118	112	149	160	3.5	3.3	38.3	0.47	1.3	0.70	2.15	1.24
780	772	119	113	161	168	3.5	3.3	39.1	0.39	1.6	0.86	2.88	1.99
861	854	129	114	170	174	8	3.3	41.8	0.33	1.8	0.99	4.13	2.55
HH 221449	HH 221410	131	116	171	179	8	3.3	42.3	0.33	1.8	0.99	4.55	2.24
HH 224335	HH 224310	132	121	192	202	7	3.3	47.3	0.33	1.8	1.0	8.14	3.06
787	772	129	116	161	168	7	3.3	39.1	0.39	1.6	0.86	2.66	1.99
782	772	122	116	161	168	3.5	3.3	39.1	0.39	1.6	0.86	2.68	1.99
71412	71750	124	118	171	181	3.5	3.3	40.1	0.42	1.4	0.79	4.0	1.71
56418	56650	122	116	149	159	3.5	3.3	38.6	0.50	1.2	0.66	1.87	0.861
37425	37625	122	115	143	152	3.5	3.3	37.0	0.61	0.99	0.54	0.886	0.488
LM 522546	LM 522510	122	116	146	154	3.5	3.3	33.7	0.40	1.5	0.82	1.65	0.784
48190	48120	122	116	146	156	3.5	3.3	38.7	0.51	1.2	0.65	1.59	0.83
56425	56650	123	117	149	159	3.5	3.3	38.6	0.50	1.2	0.66	1.8	0.861
71425	71750	126	120	171	181	3.5	3.3	40.1	0.42	1.4	0.79	3.79	1.71
HH 224340	HH 224310	139	126	192	202	8	3.3	47.3	0.33	1.8	1.0	7.58	3.06
LM 522549	LM 522510	124	118	146	154	3.5	3.3	33.7	0.40	1.5	0.82	1.55	0.784
LM 522548	LM 522510	133	118	146	154	8	3.3	33.7	0.40	1.5	0.82	1.53	0.784
64433	64700	128	121	160	172	3.5	3.3	42.4	0.52	1.2	0.64	2.64	1.11
▲ JM 822049	▲ JM 822010	124	119	149	159	3	2.5	38.3	0.50	1.2	0.66	1.64	0.842
▲ JHM 522649	▲ JHM 522610	127	122	162	172	3	2.5	40.9	0.41	1.5	0.81	3.12	1.51
71437	71750	129	123	171	181	3.5	3.3	40.1	0.42	1.4	0.79	3.58	1.71
L 623149	L 623110	123	121	143	148	1.5	1.5	27.4	0.41	1.5	0.80	0.725	0.344
64450	64700	131	125	160	172	3.5	3.3	42.4	0.52	1.2	0.64	2.39	1.11
68450	** 68709	130	123	165	172	3.5	0.8	40.0	0.50	1.2	0.66	1.95	1.0
71450	71750	132	125	171	181	3.5	3.3	40.1	0.42	1.4	0.79	3.37	1.71
938	932	141	128	187	193	7	3.3	46.9	0.33	1.8	1.0	6.01	4.11
HH 224346	HH 224310	143	131	192	202	7	3.3	47.3	0.33	1.8	1.0	7.01	3.06
71453	71750	133	126	171	181	3.5	3.3	40.1	0.42	1.4	0.79	3.31	1.71
68462	68712	132	125	163	172	3.5	3.3	40.0	0.50	1.2	0.66	1.73	1.05

Notes ** The maximum outside diameter is listed and its tolerance is negative (See Table 7.4.2 on Pages A136 and A137).

▲ The tolerances are listed in Tables 2, 3 and 4 on Pages B202 and B203.

Single-Row Tapered Roller Bearings (Inch Design)

Bore Diameter 120.000 – 165.100 mm

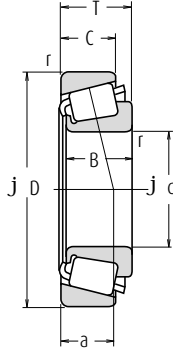

Boundary Dimensions (mm)					Basic Load Ratings (N)		Limiting Speeds (min ⁻¹)			
d	D	T	B	C	Cone	Cup	C_r	C_{Or}	Grease	Oil
					r min.	r				
120.000	170.000	25.400	25.400	19.050	3.3	3.3	130 000	219 000	1 900	2 600
	174.625	35.720	36.512	27.783	3.5	1.5	212 000	385 000	1 900	2 600
120.650	182.562	39.688	38.100	33.338	3.5	3.3	228 000	445 000	1 800	2 400
	206.375	47.625	47.625	34.925	3.3	3.3	320 000	530 000	1 600	2 200
123.825	182.562	39.688	38.100	33.338	3.5	3.3	228 000	445 000	1 800	2 400
125.000	175.000	25.400	25.400	18.288	3.3	3.3	134 000	232 000	1 800	2 400
127.000	165.895	18.258	17.462	13.495	1.5	1.5	84 500	149 000	1 900	2 600
	182.562	39.688	38.100	33.338	3.5	3.3	228 000	445 000	1 800	2 400
	196.850	46.038	46.038	38.100	3.5	3.3	315 000	560 000	1 700	2 200
	215.900	47.625	47.625	34.925	3.5	3.3	287 000	495 000	1 500	2 000
128.588	206.375	47.625	47.625	34.925	3.3	3.3	320 000	530 000	1 600	2 200
130.000	206.375	47.625	47.625	34.925	3.5	3.3	320 000	530 000	1 600	2 200
130.175	203.200	46.038	46.038	38.100	3.5	3.3	315 000	560 000	1 700	2 200
	206.375	47.625	47.625	34.925	3.5	3.3	320 000	530 000	1 600	2 200
133.350	177.008	25.400	26.195	20.638	1.5	1.5	124 000	258 000	1 800	2 400
	190.500	39.688	39.688	33.338	3.5	3.3	240 000	485 000	1 700	2 200
	196.850	46.038	46.038	38.100	3.5	3.3	315 000	560 000	1 700	2 200
	215.900	47.625	47.625	34.925	3.5	3.3	287 000	495 000	1 500	2 000
136.525	190.500	39.688	39.688	33.338	3.5	3.3	216 000	440 000	1 700	2 200
	217.488	47.625	47.625	34.925	3.5	3.3	287 000	495 000	1 500	2 000
139.700	187.325	28.575	29.370	23.020	1.5	1.5	153 000	305 000	1 700	2 200
	215.900	47.625	47.625	34.925	3.5	3.3	287 000	495 000	1 500	2 000
142.875	254.000	66.675	66.675	47.625	7.0	3.3	515 000	830 000	1 300	1 800
	200.025	41.275	39.688	34.130	3.5	3.3	227 000	460 000	1 600	2 200
146.050	193.675	28.575	28.575	23.020	1.5	1.5	170 000	355 000	1 600	2 200
	236.538	57.150	56.642	44.450	3.5	3.3	455 000	720 000	1 400	1 900
	254.000	66.675	66.675	47.625	7.0	3.3	515 000	830 000	1 300	1 800
149.225	254.000	66.675	66.675	47.625	7.0	3.3	515 000	830 000	1 300	1 800
152.400	254.000	66.675	66.675	47.625	7.0	3.3	515 000	830 000	1 300	1 800
158.750	225.425	41.275	39.688	33.338	3.5	3.3	240 000	540 000	1 400	1 900
165.100	247.650	47.625	47.625	38.100	3.5	3.3	345 000	705 000	1 300	1 700

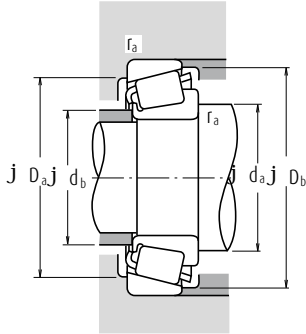

Dynamic Equivalent Load $P=XF_r+YF_a$

$F_a/F_r \leq e$		$F_a/F_r > e$	
X	Y	X	Y
1	0	0.4	Y_1

Static Equivalent Load

$$P_0=0.5F_r+Y_0F_a$$

When $F_r > 0.5F_r+Y_0F_a$, use $P_0=F_r$

The values of e , Y_1 and Y_0 are given in the table below.

Bearing Numbers		Abutment and Fillet Dimensions (mm)					Cone	Cup	Eff. Load Centers (mm)	Constant	Axial Load Factors		Mass (kg)	
CONE	CUP	d_a	d_b	D_a	D_b	r_a max.					a	e	Y_1	Y_0
▲ JL 724348	▲ JL 724314	132	127	156	163	3.3	3.3	32.9	0.46	1.3	0.72	1.08	0.591	
* M 224748	M 224710	135	129	163	168	3.5	1.5	32.2	0.33	1.8	0.99	1.9	0.866	
48282	48220	136	133	168	176	3.5	3.3	34.2	0.31	2.0	1.1	2.56	1.14	
795	792	139	134	186	198	3.3	3.3	45.7	0.46	1.3	0.72	4.44	1.9	
48286	48220	139	133	168	176	3.5	3.3	34.2	0.31	2.0	1.1	2.37	1.14	
▲ JL 725346	▲ JL 725316	138	133	161	168	3.3	3.3	34.3	0.48	1.3	0.69	1.19	0.573	
LL 225749	LL 225710	135	132	158	160	1.5	1.5	24.2	0.33	1.8	0.99	0.647	0.288	
48290	48220	141	135	168	176	3.5	3.3	34.2	0.31	2.0	1.1	2.19	1.14	
67388	67322	144	138	180	189	3.5	3.3	39.7	0.34	1.7	0.96	3.74	1.46	
74500	74850	148	141	196	208	3.5	3.3	48.4	0.49	1.2	0.68	4.92	1.99	
799	792	146	140	186	198	3.3	3.3	45.7	0.46	1.3	0.72	3.86	1.9	
797	792	148	141	186	198	3.5	3.3	45.7	0.46	1.3	0.72	3.76	1.9	
67389	67320	146	141	183	191	3.5	3.3	39.7	0.34	1.7	0.96	3.51	2.06	
799 A	792	148	142	186	198	3.5	3.3	45.7	0.46	1.3	0.72	3.74	1.9	
L 327249	L 327210	143	141	167	171	1.5	1.5	29.5	0.35	1.7	0.95	1.18	0.55	
48385	48320	148	142	177	184	3.5	3.3	35.9	0.32	1.9	1.0	2.58	1.16	
67390	67322	149	143	180	189	3.5	3.3	39.7	0.34	1.7	0.96	3.27	1.46	
74525	74850	152	146	196	208	3.5	3.3	48.4	0.49	1.2	0.68	4.44	1.99	
48393	48320	151	144	177	184	3.5	3.3	35.9	0.32	1.9	1.0	2.31	1.16	
74537	74856	155	148	197	210	3.5	3.3	48.4	0.49	1.2	0.68	4.19	2.13	
LM 328448	LM 328410	149	147	176	182	1.5	1.5	31.7	0.36	1.7	0.93	1.59	0.67	
74550	74850	158	151	196	208	3.5	3.3	48.4	0.49	1.2	0.68	3.93	1.99	
99550	99100	170	156	227	238	7	3.3	55.3	0.41	1.5	0.81	9.99	3.83	
48685	48620	158	151	185	193	3.5	3.3	37.6	0.34	1.8	0.98	2.63	1.19	
36690	36620	155	154	182	188	1.5	1.5	33.5	0.37	1.6	0.90	1.64	0.725	
HM 231140	HM 231110	164	160	217	224	3.5	3.3	45.9	0.32	1.9	1.0	6.07	2.93	
99575	99100	175	162	227	238	7	3.3	55.3	0.41	1.5	0.81	9.24	3.83	
99587	99100	178	165	227	238	7	3.3	55.3	0.41	1.5	0.81	8.86	3.83	
99600	99100	181	167	227	238	7	3.3	55.3	0.41	1.5	0.81	8.46	3.83	
46780	46720	176	169	209	218	3.5	3.3	44.3	0.38	1.6	0.86	3.69	1.66	
67780	67720	185	179	229	240	3.5	3.3	52.4	0.44	1.4	0.75	5.83	2.33	

Notes * The maximum bore diameter is listed and its tolerance is negative (See Table 7.4.1 on Page A136).

▲ The tolerances are listed in Tables 2, 3 and 4 on Pages B202 and B203.

Single-Row Tapered Roller Bearings (Inch Design)

Bore Diameter 170.000 – 206.375 mm

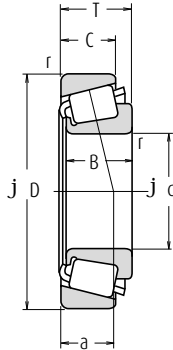

Boundary Dimensions (mm)					Basic Load Ratings (N)		Limiting Speeds (min ⁻¹)			
d	D	T	B	C	Cone	Cup	C _r	C _{0r}	Grease	Oil
					r min.					
170.000	230.000	39.000	38.000	31.000	3.0	2.5	278 000	520 000	1 300	1 800
	240.000	46.000	44.500	37.000	3.0	2.5	380 000	720 000	1 300	1 800
174.625	247.650	47.625	47.625	38.100	3.5	3.3	345 000	705 000	1 300	1 700
177.800	227.012	30.162	30.162	23.020	1.5	1.5	181 000	415 000	1 300	1 800
	247.650	47.625	47.625	38.100	3.5	3.3	345 000	705 000	1 300	1 700
	260.350	53.975	53.975	41.275	3.5	3.3	455 000	835 000	1 200	1 700
190.000	260.000	46.000	44.000	36.500	3.0	2.5	370 000	730 000	1 100	1 600
190.500	266.700	47.625	46.833	38.100	3.5	3.3	345 000	720 000	1 100	1 500
200.000	300.000	65.000	62.000	51.000	3.5	2.5	615 000	1 130 000	1 000	1 400
203.200	282.575	46.038	46.038	36.512	3.5	3.3	365 000	800 000	1 000	1 400
206.375	282.575	46.038	46.038	36.512	3.5	3.3	365 000	800 000	1 000	1 400

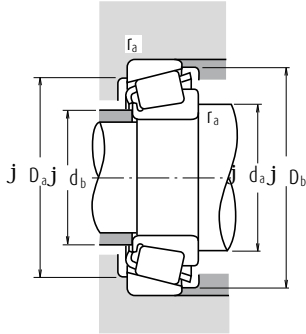

Dynamic Equivalent Load $P = X F_r + Y F_a$

$F_a/F_r \leq e$		$F_a/F_r > e$	
X	Y	X	Y
1	0	0.4	Y_1

Static Equivalent Load

$$P_0 = 0.5 F_r + Y_0 F_a$$

When $F_r > 0.5 F_r + Y_0 F_a$, use $P_0 = F_r$

The values of e , Y_1 and Y_0 are given in the table below.

Bearing Numbers		Abutment and Fillet Dimensions (mm)						Eff. Load Centers (mm)	Constant	Axial Load Factors		Mass (kg)	
CONE	CUP	d_a	d_b	D_a	D_b	Cone r_a max.	Cup			Y_1	Y_0	CONE	CUP
▲ JHM 534149	▲ JHM 534110	184	178	217	224	3	2.5	43.2	0.38	1.6	0.86	3.1	1.3
▲ JM 734449	▲ JM 734410	185	180	222	232	3	2.5	50.5	0.44	1.4	0.75	4.42	2.02
67787	67720	192	185	229	240	3.5	3.3	52.4	0.44	1.4	0.75	4.88	2.33
36990	36920	189	186	214	221	1.5	1.5	42.9	0.44	1.4	0.75	2.1	0.907
67790	67720	194	188	229	240	3.5	3.3	52.4	0.44	1.4	0.75	4.56	2.33
M 236849	M 236810	195	192	241	249	3.5	3.3	47.5	0.33	1.8	0.99	6.49	2.86
▲ JM 738249	▲ JM 738210	206	200	242	252	3	2.5	56.4	0.48	1.3	0.69	4.73	2.2
67885	67820	209	203	246	259	3.5	3.3	57.9	0.48	1.3	0.69	5.4	2.64
▲ JHM 840449	▲ JHM 840410	223	215	273	289	3.5	2.5	73.1	0.52	1.2	0.63	10.3	5.19
67983	67920	222	216	260	275	3.5	3.3	61.9	0.51	1.2	0.65	6.03	2.82
67985	67920	224	219	260	275	3.5	3.3	61.9	0.51	1.2	0.65	5.66	2.82

Note ▲ The tolerances are listed in Tables 2, 3 and 4 on Pages B202 and B203.

Double-Row Tapered Roller Bearings

Bore Diameter 40 - 90 mm

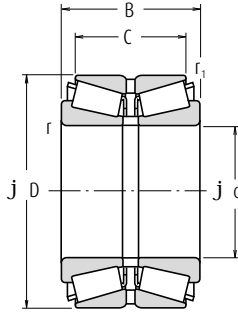

Boundary Dimensions (mm)						Basic Load Ratings (N)		Limiting Speeds (min ⁻¹)	
d	D	B ₂	C	r min.	r ₁ min.	C _r	C _{0r}	Grease	Oil
40	80	45	37.5	1.5	0.6	109 000	140 000	3 700	5 100
45	85	47	37.5	1.5	0.6	117 000	159 000	3 400	4 700
	85	55	43.5	1.5	0.6	143 000	204 000	3 400	4 700
50	90	48	38.5	1.5	0.6	131 000	183 000	3 200	4 400
	90	49	39.5	1.5	0.6	131 000	183 000	3 200	4 400
	90	55	43.5	1.5	0.6	150 000	218 000	3 200	4 400
	110	64	51.5	2.5	0.6	224 000	297 000	2 700	3 700
55	100	51	41.5	2	0.6	162 000	226 000	2 900	3 900
	100	52	42.5	2	0.6	162 000	226 000	2 900	3 900
	100	60	48.5	2	0.6	188 000	274 000	2 900	3 900
	120	70	57	2.5	0.6	256 000	342 000	2 500	3 400
60	110	53	43.5	2	0.6	178 000	246 000	2 700	3 600
	110	66	54.5	2	0.6	225 000	335 000	2 700	3 600
	130	74	59	3	1	298 000	405 000	2 300	3 200
65	120	56	46.5	2	0.6	210 000	300 000	2 400	3 200
	120	57	47.5	2	0.6	210 000	300 000	2 400	3 200
	120	73	61.5	2	0.6	269 000	405 000	2 400	3 300
65	140	79	63	3	1	340 000	465 000	2 100	2 900
70	125	57	46.5	2	0.6	227 000	325 000	2 300	3 100
	125	59	48.5	2	0.6	227 000	325 000	2 300	3 100
	125	74	61.5	2	0.6	270 000	410 000	2 300	3 100
	150	83	67	3	1	390 000	535 000	2 000	2 700
75	130	62	51.5	2	0.6	245 000	365 000	2 200	3 000
	130	74	61.5	2	0.6	283 000	440 000	2 200	3 000
	160	87	69	3	1	435 000	600 000	1 900	2 500
80	140	61	49	2.5	0.6	269 000	390 000	2 000	2 800
	140	64	51.5	2.5	0.6	269 000	390 000	2 000	2 800
	140	78	63.5	2.5	0.6	330 000	505 000	2 000	2 800
	170	92	73	3	1	475 000	655 000	1 700	2 400
85	150	70	57	2.5	0.6	315 000	465 000	1 900	2 600
	150	86	69	2.5	0.6	360 000	555 000	1 900	2 600
	180	98	77	4	1	530 000	745 000	1 600	2 200
90	160	71	58	2.5	0.6	345 000	510 000	1 800	2 400
	160	74	61	2.5	0.6	345 000	510 000	1 800	2 400
	160	94	77	2.5	0.6	440 000	700 000	1 800	2 400

Remark For other double-row tapered roller bearings not listed above, please contact NSK.

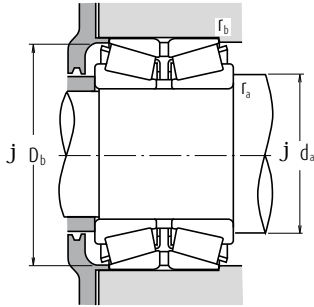

Dynamic Equivalent Load $P = X F_r + Y F_a$

$F_a/F_r \leq e$		$F_a/F_r > e$	
X	Y	X	Y
1	Y_3	0.67	Y_3

Static Equivalent Load

$$P_0 = F_r + Y_0 F_a$$

The values of e , Y_2 , Y_3 and Y_0 are given in the table below.

Bearing Numbers	Abutment and Fillet Dimensions (mm)				Constant e	Axial Load Factors			Mass (kg) approx.
	d_a min.	D_b min.	r_a max.	r_b max.		Y_2	Y_3	Y_0	
HR 40 KBE 42+L	51	75	1.5	0.6	0.37	2.7	1.8	1.8	0.97
HR 45 KBE 42+L	56	81	1.5	0.6	0.40	2.5	1.7	1.6	1.08
HR 45 KBE 52X+L	56	81	1.5	0.6	0.40	2.5	1.7	1.6	1.31
HR 50 KBE 042+L	61	87	1.5	0.6	0.42	2.4	1.6	1.6	1.20
HR 50 KBE 42+L	61	87	1.5	0.6	0.42	2.4	1.6	1.6	1.22
HR 50 KBE 52X+L	61	87	1.5	0.6	0.42	2.4	1.6	1.6	1.39
HR 50 KBE 043+L	65	104	2	0.6	0.35	2.9	2.0	1.9	2.77
HR 55 KBE 042+L	67	96	2	0.6	0.40	2.5	1.7	1.6	1.59
HR 55 KBE 1003+L	67	96	2	0.6	0.40	2.5	1.7	1.6	1.63
HR 55 KBE 52X+L	67	97	2	0.6	0.40	2.5	1.7	1.6	1.88
HR 55 KBE 43+L	70	113	2	0.6	0.35	2.9	2.0	1.9	3.52
HR 60 KBE 042+L	72	105	2	0.6	0.40	2.5	1.7	1.6	2.03
HR 60 KBE 52X+L	72	106	2	0.6	0.40	2.5	1.7	1.6	2.52
HR 60 KBE 43+L	78	122	2.5	1	0.35	2.9	2.0	1.9	4.40
HR 65 KBE 42+L	77	115	2	0.6	0.40	2.5	1.7	1.6	2.58
HR 65 KBE 1202+L	77	115	2	0.6	0.40	2.5	1.7	1.6	2.61
HR 65 KBE 52X+L	77	117	2	0.6	0.40	2.5	1.7	1.6	3.35
HR 65 KBE 43+L	83	132	2.5	1	0.35	2.9	2.0	1.9	5.42
HR 70 KBE 042+L	82	120	2	0.6	0.42	2.4	1.6	1.6	2.79
HR 70 KBE 42+L	82	120	2	0.6	0.42	2.4	1.6	1.6	2.85
HR 70 KBE 52X+L	82	121	2	0.6	0.42	2.4	1.6	1.6	3.58
HR 70 KBE 43+L	88	142	2.5	1	0.35	2.9	2.0	1.9	6.45
HR 75 KBE 42+L	87	126	2	0.6	0.44	2.3	1.6	1.5	3.15
HR 75 KBE 52X+L	87	127	2	0.6	0.44	2.3	1.6	1.5	3.73
HR 75 KBE 043+L	93	151	2.5	1	0.35	2.9	2.0	1.9	7.66
HR 80 KBE 042+L	95	134	2	0.6	0.42	2.4	1.6	1.6	3.70
HR 80 KBE 42+L	95	134	2	0.6	0.42	2.4	1.6	1.6	3.70
HR 80 KBE 52X+L	95	136	2	0.6	0.42	2.4	1.6	1.6	4.59
HR 80 KBE 043+L	98	161	2.5	1	0.35	2.9	2.0	1.9	9.02
HR 85 KBE 42+L	100	143	2	0.6	0.42	2.4	1.6	1.6	4.69
HR 85 KBE 52X+L	100	144	2	0.6	0.42	2.4	1.6	1.6	5.70
HR 85 KBE 043+L	106	169	3	1	0.35	2.9	2.0	1.9	10.8
HR 90 KBE 042+L	105	152	2	0.6	0.42	2.4	1.6	1.6	5.53
HR 90 KBE 42+L	105	152	2	0.6	0.42	2.4	1.6	1.6	5.71
HR 90 KBE 52X+L	105	154	2	0.6	0.42	2.4	1.6	1.6	7.26



Double-Row Tapered Roller Bearings

Bore Diameter 90 – 120 mm

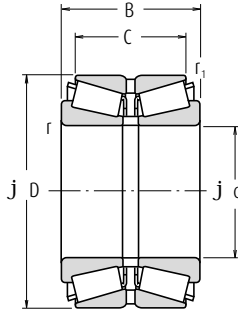

Boundary Dimensions (mm)						Basic Load Ratings (N)		Limiting Speeds (min ⁻¹)		
d	D	B ₂	C	r min.	r ₁ min.	C _r	C _{0r}	Grease	Oil	
90	190	102	81	4	1	595 000	845 000	1 600	2 100	
	190	144	115	4	1	770 000	1 180 000	1 600	2 200	
95	170	78	63	3	1	385 000	570 000	1 700	2 300	
	170	100	83	3	1	495 000	800 000	1 700	2 300	
100	200	108	85	4	1	640 000	910 000	1 500	2 000	
	165	52	46	2.5	0.6	222 000	340 000	1 700	2 300	
100	180	81	64	3	1	435 000	665 000	1 600	2 200	
	180	81	65	3	1	435 000	665 000	1 600	2 200	
	180	82	66	3	1	435 000	665 000	1 600	2 200	
	180	83	67	3	1	435 000	665 000	1 600	2 200	
	180	105	85	3	1	555 000	905 000	1 600	2 200	
	180	107	87	3	1	555 000	905 000	1 600	2 200	
	180	110	90	3	1	555 000	905 000	1 600	2 200	
	215	112	87	4	1	725 000	1 050 000	1 400	1 900	
	105	190	88	70	3	1	480 000	735 000	1 500	2 000
		190	117	96	3	1	620 000	1 020 000	1 500	2 000
190		115	95	3	1	620 000	1 020 000	1 500	2 000	
110	225	116	91	4	1	780 000	1 130 000	1 300	1 800	
	180	56	50	2.5	0.6	264 000	400 000	1 500	2 000	
	180	70	56	2.5	0.6	340 000	555 000	1 500	2 000	
	180	125	100	2.5	0.6	550 000	1 060 000	1 500	2 100	
	200	90	72	3	1	540 000	840 000	1 400	1 900	
	200	92	74	3	1	540 000	840 000	1 400	1 900	
	200	120	100	3	1	685 000	1 130 000	1 400	1 900	
	200	121	101	3	1	685 000	1 130 000	1 400	1 900	
	240	118	93	4	1.5	830 000	1 190 000	1 200	1 700	
	120	180	46	41	2.5	0.6	184 000	296 000	1 500	2 000
180		58	46	2.5	0.6	260 000	450 000	1 500	2 000	
200		62	55	2.5	0.6	310 000	500 000	1 400	1 800	
200		78	62	2.5	0.6	415 000	690 000	1 400	1 900	
200		100	84	2.5	0.6	515 000	885 000	1 400	1 800	
215		97	78	3	1	575 000	900 000	1 300	1 800	
215		132	109	3	1	750 000	1 270 000	1 300	1 800	
260		128	101	4	1	915 000	1 310 000	1 100	1 500	
260		188	145	4	1	1 320 000	2 110 000	1 100	1 500	

Remark For other double-row tapered roller bearings not listed above, please contact NSK.

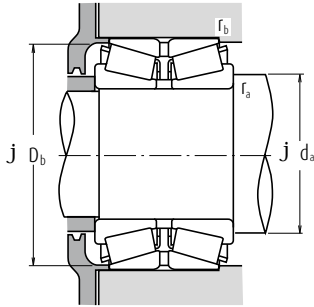

Dynamic Equivalent Load $P = X F_r + Y F_a$

$F_a/F_r \leq e$		$F_a/F_r > e$	
X	Y	X	Y
1	Y_3	0.67	Y_3

Static Equivalent Load

$$P_0 = F_r + Y_0 F_a$$

The values of e , Y_2 , Y_3 and Y_0 are given in the table below.

Bearing Numbers	Abutment and Fillet Dimensions (mm)				Constant e	Axial Load Factors			Mass (kg) approx.
	d_a min.	D_b min.	r_a max.	r_b max.		Y_2	Y_3	Y_0	
HR 90 KBE 043+L	111	178	3	1	0.35	2.9	2.0	1.9	12.7
HR 90 KBE 1901+L	111	179	3	1	0.35	2.9	2.0	1.9	17.9
HR 95 KBE 42+L	113	161	2.5	1	0.42	2.4	1.6	1.6	6.75
HR 95 KBE 52+L	113	163	2.5	1	0.42	2.4	1.6	1.6	8.60
HR 95 KBE 43+L	116	187	3	1	0.35	2.9	2.0	1.9	14.7
100 KBE 31+L	115	156	2	0.6	0.33	3.0	2.0	2.0	4.04
HR100 KBE 1805+L	118	170	2.5	1	0.42	2.4	1.6	1.6	8.16
HR100 KBE 042+L	118	170	2.5	1	0.42	2.4	1.6	1.6	8.13
HR100 KBE 1801+L	118	170	2.5	1	0.42	2.4	1.6	1.6	8.22
HR100 KBE 42+L	118	170	2.5	1	0.42	2.4	1.6	1.6	8.7
HR100 KBE 1802+L	118	173	2.5	1	0.42	2.4	1.6	1.6	10.6
HR100 KBE 52X+L	118	173	2.5	1	0.42	2.4	1.6	1.6	10.7
HR100 KBE 1804+L	118	173	2.5	1	0.42	2.4	1.6	1.6	11
HR100 KBE 043+L	121	200	3	1	0.35	2.9	2.0	1.9	18.1
HR105 KBE 42X+L	123	179	2.5	1	0.42	2.4	1.6	1.6	9.76
HR105 KBE 1902+L	123	182	2.5	1	0.42	2.4	1.6	1.6	13.4
HR105 KBE 52+L	123	182	2.5	1	0.42	2.4	1.6	1.6	13.1
HR105 KBE 043+L	126	209	3	1	0.35	2.9	2.0	1.9	20.4
110 KBE 31+L	125	172	2	0.6	0.39	2.6	1.7	1.7	5.11
110 KBE 031+L	125	172	2	0.6	0.39	2.6	1.7	1.7	6.33
110 KBE 1802+L	125	172	2	0.6	0.26	3.8	2.6	2.5	11.4
HR110 KBE 42+L	128	190	2.5	1	0.42	2.4	1.6	1.6	11.2
HR110 KBE 42X+L	128	190	2.5	1	0.42	2.4	1.6	1.6	11.5
HR110 KBE 2001+L	128	193	2.5	1	0.42	2.4	1.6	1.6	15.4
HR110 KBE 52X+L	128	193	2.5	1	0.42	2.4	1.6	1.6	15.2
HR110 KBE 043+L	131	223	3	1.5	0.35	2.9	2.0	1.9	23.6
120 KBE 30+L	135	172	2	0.6	0.40	2.5	1.7	1.6	3.75
120 KBE 030+L	135	172	2	0.6	0.39	2.6	1.7	1.7	4.64
120 KBE 31+L	135	190	2	0.6	0.39	2.6	1.7	1.7	7.35
120 KBE 031+L	135	190	2	0.6	0.39	2.6	1.7	1.7	8.97
120 KBE 2001+L	135	193	2	0.6	0.37	2.7	1.8	1.8	11.3
HR120 KBE 42X+L	138	204	2.5	1	0.44	2.3	1.6	1.5	13.7
HR120 KBE 52X+L	138	207	2.5	1	0.44	2.3	1.6	1.5	18.8
HR120 KBE 43+L	141	240	3	1	0.35	2.9	2.0	1.9	29.4
HR120 KBE 2601+L	141	242	3	1	0.35	2.9	2.0	1.9	44.6



Double-Row Tapered Roller Bearings

Bore Diameter 125 – 150 mm

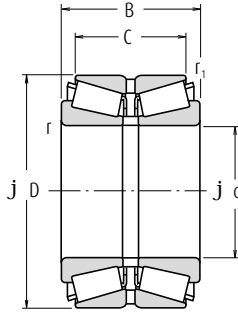

Boundary Dimensions (mm)						Basic Load Ratings (N)		Limiting Speeds (min ⁻¹)	
d	D	B ₂	C	r min.	r ₁ min.	C _r	C _{0r}	Grease	Oil
125	210	110	88	4	1	560 000	1 030 000	1 300	1 800
130	230	98	78.5	4	1	640 000	1 010 000	1 200	1 600
	230	100	80.5	4	1	640 000	1 010 000	1 200	1 600
	280	137	107.5	5	1.5	940 000	1 350 000	1 000	1 400
	230	145	115	4	1	905 000	1 580 000	1 200	1 700
	230	145	117.5	4	1	905 000	1 580 000	1 200	1 700
	230	150	120	4	1	905 000	1 580 000	1 200	1 700
140	210	53	47	2.5	0.6	280 000	495 000	1 200	1 700
	210	66	53	2.5	1	305 000	530 000	1 200	1 700
	210	106	94	2.5	0.6	555 000	1 200 000	1 300	1 700
	225	68	61	3	1	400 000	630 000	1 200	1 600
	225	84	68	3	1	490 000	850 000	1 200	1 600
	225	85	68	3	1	490 000	850 000	1 200	1 600
	230	120	94	3	1	685 000	1 270 000	1 200	1 600
	230	140	110	3	1	820 000	1 550 000	1 200	1 600
	240	132	106	4	1.5	685 000	1 360 000	1 100	1 500
	250	102	82.5	4	1	670 000	1 030 000	1 100	1 500
	250	153	125.5	4	1	1 040 000	1 830 000	1 100	1 500
	300	145	115.5	5	1.5	1 030 000	1 480 000	1 000	1 300
150	225	56	50	3	1	300 000	545 000	1 200	1 600
	225	70	56	3	1	395 000	685 000	1 200	1 600
	250	80	71	3	1	510 000	810 000	1 100	1 400
	250	100	80	3	1	630 000	1 090 000	1 100	1 400
	250	115	95	3	1	745 000	1 320 000	1 100	1 500
	260	150	115	4	1	815 000	1 520 000	1 100	1 400
	270	109	87	4	1	830 000	1 330 000	1 000	1 400
	270	164	130	4	1	1 210 000	2 150 000	1 000	1 400
	270	174	140	4	1	1 210 000	2 150 000	1 000	1 400
	320	154	120	5	1.5	1 420 000	2 130 000	900	1 200

Remark For other double-row tapered roller bearings not listed above, please contact NSK.

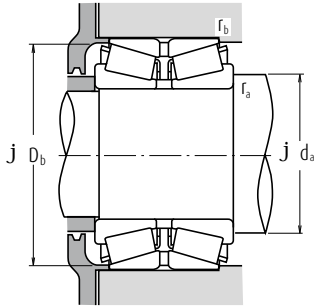

Dynamic Equivalent Load $P = XF_r + YF_a$

$F_a/F_r \leq e$		$F_a/F_r > e$	
X	Y	X	Y
1	Y_3	0.67	Y_3

Static Equivalent Load

$$P_0 = F_r + Y_0 F_a$$

The values of e , Y_2 , Y_3 and Y_0 are given in the table below.

Bearing Numbers	Abutment and Fillet Dimensions (mm)				Constant e	Axial Load Factors			Mass (kg) approx.
	d_a min.	D_b min.	r_a max.	r_b max.		Y_2	Y_3	Y_0	
125 KBE 2101+L	146	201	3	1	0.43	2.3	1.6	1.5	14.5
HR130 KBE 42+L	151	220	3	1	0.44	2.3	1.6	1.5	15.8
HR130 KBE 2301+L	151	220	3	1	0.44	2.3	1.6	1.5	15.9
130 KBE 43+L	157	258	4	1.5	0.36	2.8	1.9	1.8	35
HR130 KBE 2302+L	151	221	3	1	0.44	2.3	1.6	1.5	24.1
HR130 KBE 52+L	151	222	3	1	0.44	2.3	1.6	1.5	23.8
HR130 KBE 2303+L	151	221	3	1	0.44	2.3	1.6	1.5	24.2
140 KBE 30+L	155	202	2	0.6	0.39	2.6	1.7	1.7	6.02
140 KBE 030+L	155	202	2	1	0.40	2.5	1.7	1.6	7.02
140 KBE 2101+L	155	202	2	0.6	0.33	3.0	2.0	2.0	12.3
140 KBE 31+L	158	216	2.5	1	0.39	2.6	1.7	1.7	9.31
140 KBE 031+L	158	215	2.5	1	0.39	2.6	1.7	1.7	11.6
140 KBE 2201+L	158	215	2.5	1	0.39	2.6	1.7	1.7	11.7
140 KBE 2301+L	158	220	2.5	1	0.33	3.0	2.0	2.0	17.6
140 KBE 2302+L	158	221	2.5	1	0.35	2.9	2.0	1.9	20.7
140 KBE 2401+L	161	227	3	1.5	0.44	2.3	1.5	1.5	22.7
HR140 KBE 42+L	161	237	3	1	0.44	2.3	1.6	1.5	18.9
HR140 KBE 52X+L	161	241	3	1	0.44	2.3	1.6	1.5	29.6
140 KBE 43+L	167	275	4	1.5	0.36	2.8	1.9	1.8	42.6
150 KBE 30+L	168	213	2.5	1	0.35	2.9	2.0	1.9	7.41
150 KBE 030+L	168	215	2.5	1	0.35	2.9	2.0	1.9	8.70
150 KBE 31+L	168	240	2.5	1	0.40	2.5	1.7	1.6	14.2
150 KBE 031+L	168	238	2.5	1	0.39	2.6	1.7	1.7	17.8
150 KBE 2502+L	168	238	2.5	1	0.37	2.7	1.8	1.8	20.9
150 KBE 2601+L	171	242	3	1	0.43	2.3	1.6	1.5	30.0
HR150 KBE 42+L	171	253	3	1	0.44	2.3	1.6	1.5	24.3
HR150 KBE 52X+L	171	257	3	1	0.44	2.3	1.6	1.5	37.3
HR150 KBE 2701+L	171	257	3	1	0.44	2.3	1.6	1.5	39.7
HR150 KBE 43+L	177	295	4	1.5	0.35	2.9	2.0	1.9	53.4



Double-Row Tapered Roller Bearings

Bore Diameter 160 – 200 mm

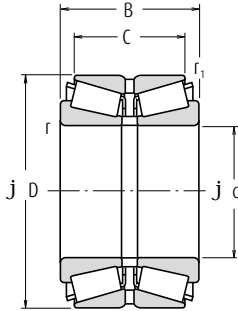

Boundary Dimensions (mm)						Basic Load Ratings (N)		Limiting Speeds (min ⁻¹)	
d	D	B ₂	C	r min.	r ₁ min.	C _r	C _{0r}	Grease	Oil
160	240	60	53	3	1	355 000	580 000	1 100	1 500
	240	75	60	3	1	395 000	710 000	1 100	1 500
	240	110	90	3	1	650 000	1 290 000	1 100	1 500
	270	86	76	3	1	540 000	885 000	1 000	1 300
	270	108	86	3	1	775 000	1 380 000	1 000	1 300
	270	140	120	3	1	990 000	1 880 000	1 000	1 300
	280	150	125	4	1	1 100 000	2 020 000	1 000	1 300
	290	115	91	4	1	800 000	1 220 000	900	1 300
	290	178	144	4	1	1 360 000	2 440 000	1 000	1 300
	340	160	126	5	1.5	1 310 000	1 920 000	800	1 100
165	290	150	125	4	1	1 140 000	2 130 000	900	1 300
170	250	85	65	3	1	435 000	845 000	1 000	1 400
	260	67	60	3	1	400 000	700 000	1 000	1 300
	260	84	67	3	1	575 000	1 030 000	1 000	1 300
	280	88	78	3	1	630 000	1 040 000	900	1 300
	280	110	88	3	1	820 000	1 450 000	900	1 300
	280	150	130	3	1	1 110 000	2 160 000	1 000	1 300
	310	192	152	5	1.5	1 590 000	2 910 000	900	1 200
180	280	74	66	3	1	455 000	810 000	900	1 300
	280	93	74	3	1	655 000	1 220 000	900	1 200
	300	96	85	4	1.5	725 000	1 210 000	900	1 200
	300	120	96	4	1.5	940 000	1 690 000	900	1 200
	320	127	99	5	1.5	895 000	1 390 000	800	1 200
	320	192	152	5	1.5	1 640 000	3 050 000	900	1 200
	340	180	140	5	1.5	1 410 000	2 510 000	800	1 100
190	290	75	67	3	1	490 000	845 000	900	1 200
	290	94	75	3	1	670 000	1 230 000	900	1 200
	320	104	92	4	1.5	800 000	1 380 000	800	1 100
	320	130	104	4	1.5	1 070 000	1 960 000	800	1 100
	340	133	105	5	1.5	990 000	1 580 000	800	1 100
200	340	204	160	5	1.5	1 910 000	3 550 000	800	1 100
	310	152	123	3	1	1 300 000	2 740 000	800	1 100
	320	146	110	5	1.5	990 000	2 120 000	800	1 100
	330	180	140	5	1.5	1 390 000	2 730 000	800	1 100
	340	112	100	4	1.5	940 000	1 670 000	800	1 000
	340	140	112	4	1.5	1 260 000	2 250 000	800	1 000
	360	142	110	5	1.5	1 100 000	1 780 000	700	1 000
	360	218	174	5	1.5	2 070 000	3 850 000	800	1 000

Remark For other double-row tapered roller bearings not listed above, please contact NSK.

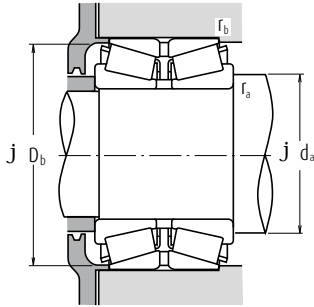

Dynamic Equivalent Load $P = X F_r + Y F_a$

$F_a/F_r \leq e$		$F_a/F_r > e$	
X	Y	X	Y
1	Y_3	0.67	Y_2

Static Equivalent Load

$$P_0 = F_r + Y_0 F_a$$

The values of e , Y_2 , Y_3 and Y_0 are given in the table below.

Bearing Numbers	Abutment and Fillet Dimensions (mm)				Constant e	Axial Load Factors			Mass (kg) approx.
	d_a min.	D_b min.	r_a max.	r_b max.		Y_2	Y_3	Y_0	
160 KBE 30+L	178	231	2.5	1	0.37	2.7	1.8	1.8	8.56
160 KBE 030+L	178	230	2.5	1	0.40	2.5	1.7	1.6	10.5
160 KBE 2401+L	178	232	2.5	1	0.38	2.6	1.8	1.7	16.2
160 KBE 31+L	178	255	2.5	1	0.40	2.5	1.7	1.6	18.6
160 KBE 031+L	178	256	2.5	1	0.39	2.6	1.7	1.7	23.1
160 KBE 2701+L	178	261	2.5	1	0.39	2.6	1.7	1.7	30.6
160 KBE 2801+L	181	266	3	1	0.32	3.2	2.1	2.1	35.9
160 KBE 42+L	181	275	3	1	0.43	2.3	1.6	1.5	28.2
HR160 KBE 52X+L	181	277	3	1	0.44	2.3	1.6	1.5	47.3
160 KBE 43+L	187	314	4	1.5	0.36	2.8	1.9	1.8	60.4
165 KBE 2901+L	186	272	3	1	0.33	3.1	2.1	2.0	39.5
170 KBE 2501+L	188	241	2.5	1	0.44	2.3	1.5	1.5	12.3
170 KBE 30+L	188	248	2.5	1	0.40	2.5	1.7	1.6	11.8
170 KBE 030+L	188	249	2.5	1	0.39	2.6	1.7	1.7	14.4
170 KBE 31+L	188	266	2.5	1	0.39	2.6	1.7	1.7	19.7
170 KBE 031+L	188	268	2.5	1	0.39	2.6	1.7	1.7	24.2
170 KBE 2802+L	188	269	2.5	1	0.39	2.6	1.7	1.7	34.6
HR170 KBE 52X+L	197	297	4	1.5	0.44	2.3	1.6	1.5	57.3
180 KBE 30+L	198	265	2.5	1	0.40	2.5	1.7	1.6	15.4
180 KBE 030+L	198	265	2.5	1	0.35	2.9	2.0	1.9	14.4
180 KBE 31+L	201	284	3	1.5	0.39	2.6	1.7	1.7	24.8
180 KBE 031+L	201	287	3	1.5	0.39	2.6	1.7	1.7	31.1
180 KBE 42+L	207	300	4	1.5	0.44	2.3	1.5	1.5	36.5
HR180 KBE 52X+L	207	308	4	1.5	0.45	2.2	1.5	1.5	59.2
180 KBE 3401+L	207	305	4	1.5	0.43	2.3	1.6	1.5	68.1
190 KBE 30+L	208	279	2.5	1	0.39	2.6	1.7	1.7	16.2
190 KBE 030+L	208	279	2.5	1	0.40	2.5	1.7	1.6	20.1
190 KBE 31+L	211	301	3	1.5	0.40	2.5	1.7	1.6	30.9
190 KBE 031+L	211	302	3	1.5	0.39	2.6	1.7	1.7	39.0
190 KBE 42+L	217	320	4	1.5	0.40	2.5	1.7	1.6	43.9
HR190 KBE 52X+L	217	327	4	1.5	0.44	2.3	1.6	1.5	70.8
HR200 KBE 3101+L	218	301	2.5	1	0.43	2.3	1.6	1.5	40.1
200 KBE 3201+L	227	301	4	1.5	0.52	1.9	1.3	1.3	41.6
200 KBE 3301+L	227	316	4	1.5	0.42	2.4	1.6	1.6	54.4
200 KBE 31+L	221	321	3	1.5	0.40	2.5	1.7	1.6	38.8
200 KBE 031+L	221	324	3	1.5	0.39	2.6	1.7	1.7	47.0
200 KBE 42+L	227	338	4	1.5	0.40	2.5	1.7	1.6	52.6
HR200 KBE 52+L	227	344	4	1.5	0.41	2.5	1.7	1.6	88.3



Double-Row Tapered Roller Bearings

Bore Diameter 206 – 260 mm

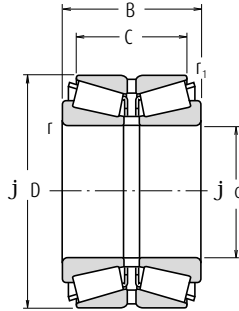

Boundary Dimensions (mm)						Basic Load Ratings (N)		Limiting Speeds (min ⁻¹)	
d	D	B ₂	C	r min.	r ₁ min.	C _r	C _{0r}	Grease	Oil
206	283	102	83	4	1.5	580 000	1 430 000	900	1 200
210	355	116	103	4	1.5	905 000	1 520 000	700	1 000
220	300	110	88	3	1	730 000	1 710 000	800	1 100
	340	90	80	4	1.5	695 000	1 280 000	700	1 000
	340	113	90	4	1.5	920 000	1 830 000	700	1 000
	370	120	107	5	1.5	1 110 000	1 940 000	700	1 000
	370	150	120	5	1.5	1 460 000	2 760 000	700	1 000
	400	158	122	5	1.5	1 390 000	2 300 000	600	900
240	360	92	82	4	1.5	780 000	1 490 000	700	900
	360	115	92	4	1.5	1 020 000	2 040 000	700	900
	400	128	114	5	1.5	1 180 000	2 190 000	600	900
	400	160	128	5	1.5	1 620 000	3 050 000	600	900
	400	209	168	5	1.5	2 220 000	4 450 000	600	900
250	380	98	87	4	1	795 000	1 460 000	600	900
260	400	104	92	5	1.5	895 000	1 670 000	600	800
	400	130	104	5	1.5	1 210 000	2 460 000	600	800
	440	144	128	5	1.5	1 540 000	2 760 000	600	800
	440	172	145	5	1.5	1 870 000	3 500 000	600	800
	440	180	144	5	1.5	2 110 000	4 150 000	600	800

Remark For other double-row tapered roller bearings not listed above, please contact NSK.

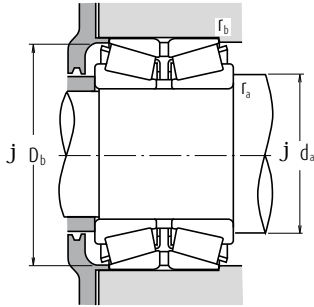

Dynamic Equivalent Load $P = XF_r + YF_a$

$F_a/F_r \leq e$		$F_a/F_r > e$	
X	Y	X	Y
1	Y_3	0.67	Y_3

Static Equivalent Load

$$P_0 = F_r + Y_0 F_a$$

The values of e , Y_2 , Y_3 and Y_0 are given in the table below.

Bearing Numbers	Abutment and Fillet Dimensions (mm)				Constant e	Axial Load Factors			Mass (kg) approx.
	d_a min.	D_b min.	r_a max.	r_b max.		Y_2	Y_3	Y_0	
206 KBE 2801+L	227	275	3	1.5	0.51	2.0	1.3	1.3	18.1
210 KBE 31+L	231	338	3	1.5	0.46	2.2	1.5	1.4	41.7
220 KBE 3001+L	238	292	2.5	1	0.37	2.7	1.8	1.8	21.2
220 KBE 30+L	241	324	3	1.5	0.40	2.5	1.7	1.6	27.9
220 KBE 030+L	241	327	3	1.5	0.40	2.5	1.7	1.6	34.7
220 KBE 31+L	247	345	4	1.5	0.39	2.6	1.7	1.7	48.3
220 KBE 031+L	247	349	4	1.5	0.39	2.6	1.7	1.7	60.2
220 KBE 42+L	247	371	4	1.5	0.40	2.5	1.7	1.6	74.2
240 KBE 30+L	261	344	3	1.5	0.39	2.6	1.7	1.7	30.1
240 KBE 030+L	261	344	3	1.5	0.35	2.9	2.0	1.9	37.3
240 KBE 31+L	267	380	4	1.5	0.43	2.3	1.6	1.5	60.0
240 KBE 031+L	267	378	4	1.5	0.39	2.6	1.7	1.7	73.6
240 KBE 4003+L	267	384	4	1.5	0.33	3.0	2.0	2.0	96.4
250 KBE 3801+L	271	365	3	1	0.40	2.5	1.7	1.6	35.5
260 KBE 30+L	287	379	4	1.5	0.40	2.5	1.7	1.6	43.4
260 KBE 030+L	287	382	4	1.5	0.40	2.5	1.7	1.6	54.1
260 KBE 31+L	287	416	4	1.5	0.39	2.6	1.7	1.7	82.5
260 KBE 4401+L	287	414	4	1.5	0.38	2.6	1.8	1.7	98.1
260 KBE 031+L	287	416	4	1.5	0.39	2.6	1.7	1.7	104.0



Spherical Roller Bearings



7. SPHERICAL ROLLER BEARINGS

Introduction..... B 276

TECHNICAL DATA

Free Space of Spherical Roller Bearings B 278

Measuring Bearing Clearance..... B 280

TECHNICAL DATA

SPHERICAL ROLLER BEARINGS

Cylindrical Bores, Tapered Bores Bore Diameter 20 - 1400 mm B 284



Spherical Roller Bearings

DESIGNS, TYPES AND FEATURES

High load capacity designs EA, C, CD and CA, shown in the figures are available. Types EA, C and CD have pressed steel cages, and type CA has machined brass cage. The EA type bearings listed here are classified as NSKHPS bearings, which offer particularly high load-carrying capacity, high limiting speeds and are highly functional under high-temperature operating conditions of up to 200°C.

An oil groove and holes are provided in the outer ring to supply lubricant and the bearing numbers are suffixed with E4.

To use bearings with oil grooves and holes, it is recommended to provide an oil groove in the housing bore, since the depth of the groove in the bearing is limited. The number and dimensions of the oil groove and holes are shown in Tables 1 and 2.

If bearings with a hole for a locking pin to prevent outer ring rotation are required, please inform NSK.

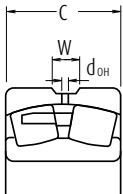
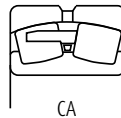
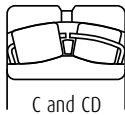

Table 1 Dimensions of Oil Grooves and Holes Units : mm

Nominal Outer Ring Width C		Oil Groove Width W	Hole Diameter d_{OH}
over	incl.		
18	30	5	2.5
30	40	6	3
40	50	7	4
50	65	8	5
65	80	10	6
80	100	12	8
100	120	15	10
120	160	20	12
160	200	25	15
200	250	30	20
250	315	35	20
315	400	40	25
400	—	40	25

Table 2 Number of Oil Holes

Nominal Outer Ring Diameter D (mm)		Number of Holes
over	incl.	
—	180	4
180	250	6
250	315	6
315	400	6
400	500	6
500	630	8
630	800	8
800	1000	8
1000	1250	8
1250	1600	8
1600	2000	8

	Table	Pages
Tolerance and Running Accuracy	7.2	A 128 to A 131
Recommended Fits	8.3	A 164
	8.5	A 165
Internal Clearance	8.16	A 172

PERMISSIBLE MISALIGNMENT

The permissible misalignment of spherical roller bearings varies depending on the size and load, but it is approximately 0.018 to 0.045 radian (1° to 2.5°) with normal loads.

LIMITING SPEEDS (GREASE)

The limiting speeds (grease) listed in the bearing tables should be adjusted depending on the bearing load conditions. Also, higher speeds are attainable by making changes in the lubrication method, cage design, etc. Refer to Page A098 for detailed information.

PRECAUTIONS FOR USE OF SPHERICAL ROLLER BEARINGS

If the load on spherical roller bearings becomes too small during operation or if the ratio of axial and radial loads is larger than the value of 'e' (listed in the bearing tables), slippage occurs between the rollers and raceways, which may result in smearing. The higher the weight of the rollers and cage, the higher this tendency becomes, especially for large spherical roller bearings.

If very small bearing loads are expected, please contact NSK for selection of an appropriate bearing.



Spherical Roller Bearings

TECHNICAL DATA

Free Space of Spherical Roller Bearings

The spherical roller bearing has self-aligning ability and capacity to carry substantially large radial and bi-axial loads. For these reasons, this bearing is used widely in many applications. Application problems include a long span, which causes substantial deflection of the shaft, as well as installation errors and axial misalignment. These bearings may be exposed to a large radial or shock loads.

Grease lubrication is common for spherical roller bearings because it simplifies the seal construction around the housing and makes maintenance and inspection easier. In this case, it is important to select a grease appropriate to the operating conditions and to fill the bearing with the proper amount of grease considering the housing internal space.

As a reference, the bearing free space for conventional types plus four other types (EA, C, CD, and CA) is shown in Table 1. Under general operating conditions, it is appropriate to pack a large quantity of grease into the bearing internal space and to pack grease into the housing internal space other than the bearing itself, to the extent of 1/3 to 2/3 that of the free space.

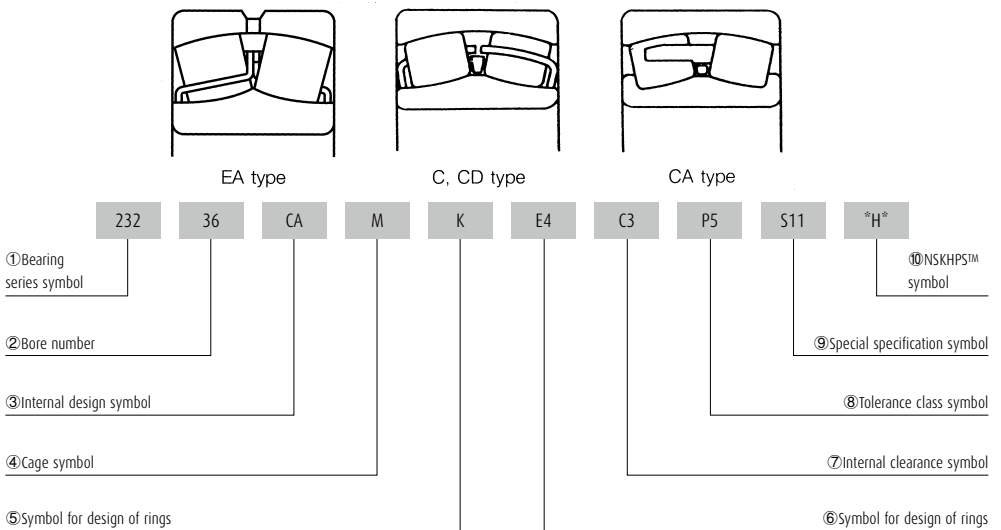

- ① Bearing series symbol 239, 230, 240, 231, 241, 222, 232, 213, 223: Spherical Roller Bearings
- ② Bore number Bore number indicates bore diameter. Bore number $\times 5$ (mm)
- ③ Internal design symbol EA, CA: High Load Capacity
- ④ Cage symbol M : Machined Brass Cage (for CA Design)
Omitted: Pressed Steel Cage (for EA Design)
- ⑤ ⑥ Symbol for design of rings K: Tapered Bore of Inner Ring (Taper 1:12)
K30: Tapered Bore of Inner Ring (Taper 1:30)
E4: Lubricating groove in outside surface and Holes in outer ring
- ⑦ Internal clearance symbol Omitted: CN clearance, C3: Clearance greater than CN,
C4: Clearance greater than C3, C5: Clearance greater than C4
- ⑧ Tolerance class symbol Omitted: ISO Normal, P6: ISO Class 6, P5: ISO Class 5, P4: ISO Class 4
- ⑨ Special specification symbol S11; Dimensional Stabilizing Treatment Working Temperature Lower than 200°C
(Omitted for EA Design)
- ⑩ NSKHPSTM *H*: NSKHPSTM Symbol
Tolerance Class: ISO Normal

Table 1 Free Space of Spherical Roller Bearing (EA, C, CD, and CA)

Units : cm³

Bearing Bore No.	Bearing Free Space				
	Bearing Series				
	230	231	222	232	223
11	—	—	29	—	78
12	—	—	42	—	96
13	—	—	48	—	113
14	—	—	52	—	139
15	—	—	57	—	170
16	—	—	71	—	206
17	—	—	91	—	234
18	—	—	110	130	283
19	—	—	135	—	327
20	—	—	169	203	410
22	100	150	242	294	560
24	109	228	297	340	700
26	161	240	365	405	955
28	170	292	400	530	1 230
30	209	465	505	680	1 430
32	254	575	680	850	1 710
34	355	610	785	1 090	2 070
36	465	785	810	1 120	2 460
38	565	970	1 160	1 340	2 830
40	715	1 160	1 400	1 640	2 900
44	940	1 500	1 880	2 270	3 750
48	1 030	1 900	2 550	3 550	4 700
52	1 530	2 940	3 300	4 750	5 900
56	1 820	3 150	3 400	4 950	7 250
60	2 200	4 050	4 300	6 200	8 750



Remarks 22211 to 22226, 22311 to 22324 are EA Type Bearings.
 23122 to 23148, 23218 to 23244 are C Type Bearings.
 23022 to 23036, 22228 to 22236 are CD Type Bearings.
 23038 to 23060, 23152 to 23160, 22238 to 22260,
 23248 to 23260, and 22326 to 22360 are CA Type Bearing.

Spherical Roller Bearings

Measurement of Bearing Clearance

For the bearing mounting, the measurement of internal bearing clearance is a most important task. Before handling the bearing and measuring the internal bearing clearance, be sure to wear thin rubber gloves. (If a bearing is touched by a bare hand, the touched part may rust.) When measuring the internal bearing clearance, pay careful attention so that the rollers are positioned correctly.

1. Measurement of Bearing Clearance

To measure only internal bearing clearance, set the bearing standing upright (vertically) on a flat surface, while holding its outer ring with one hand. While paying attention not to incline the inner and outer rings, stabilize the rollers by turning the inner ring to the right and left by about one half to one full rotation. Adjust rollers until one randomly chosen roller of the double rows is positioned to be exactly at the top. Now, the internal clearance is measured with a thickness gauge. The measurement position and measured point vary slightly depending on the size of the outer ring outside diameter.

1.1 Bearing Outside Diameter Is Smaller Than 200 mm

Insert the thickness gauge between rollers of 2 rows which have a roller positioned exactly at the top of the bearing and outer ring. Now, measure the internal clearance (Δ_r). (Fig. 1)

1.2 Bearing Outside Diameter Is Larger Than 200 mm

Insert the thickness gauge between the rollers of the 2 rows, which each have been positioned to be exactly at the top, and outer ring and between 2 rows of bearing at symmetrical position relative to the bearing center, then measure the respective

internal clearance of the bearing. (Fig. 2). For the internal bearing clearance (Δ_r), take that value measured between 2 rows of just top of bearing and outer ring as respectively Δ_{r11} and Δ_{r12} and that value measured just at top of the bearing as Δ_{r1} .

$$\Delta_{r1} = 1/2 (\Delta_{r11} + \Delta_{r12})$$

Among internal clearances between 2 rows of rollers that are symmetrical relative to the bearing center and outer ring, take that measurement between 2 rows of rollers of left side respectively as Δ_{rL1} and Δ_{rL2} . The internal clearance on the left side of the bearing is Δ_{rL} :

$$\Delta_{rL} = 1/2 (\Delta_{rL1} + \Delta_{rL2})$$

Take that measurement between 2 rows of rollers of right side respectively as Δ_{rR1} and Δ_{rR2} . The internal clearance of the right side of the bearing is Δ_{rR} :

$$\Delta_{rR} = 1/2 (\Delta_{rR1} + \Delta_{rR2})$$

The internal bearing clearance (Δ_r) is given by the following equation:

$$\Delta_r = 1/2 (\Delta_{r1} + \Delta_{rL} + \Delta_{rR})$$

2. Measuring Bearing Clearance When Mounted on Shaft or Sleeve

Basically, the measurement of the clearance is taken when the outer ring of bearing hangs down from rollers. At first, while holding the bearing up-right, rotate the outer ring in the clockwise and counter-clockwise directions by one half to one full rotation until both rows have a randomly chosen roller positioned exactly at the bottom. The clearance is measured with a thickness gauge but diameter.

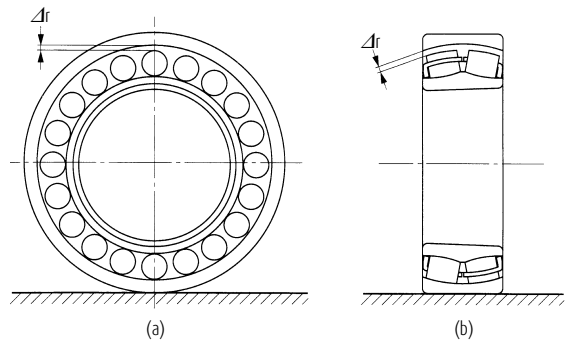

Fig. 1 Clearance Measurement Point (Bearing Outside Diameter: Less Than 200 mm)

the measurement point varies slightly depending on the size of the outer ring outside diameter.

2.1 Bearing Outside Diameter Is Smaller Than 200 mm

Insert the thickness gauge between rollers of 2 rows of just at the bottom of the bearing and outer ring and measure the internal clearance (Δ_{IS}). (Fig. 3)

2.2 Bearing Outside Diameter Is Larger Than 200 mm

Insert the thickness gauge between rollers of 2 rows that are positioned just at the bottom of bearing and outer ring and between 2 rows of bearing rollers symmetrical relative to the bearing center, then, measure the respective internal clearance of the bearing. (Fig. 3) For the internal bearing clearance (Δ_I), take the measurement when the roller is positioned exactly at the bottom, since the bearing has 2 rows, two values must be measured. The bearing internal clearance is Δ_{IS1} and Δ_{IS2} while that value measured at the exact bottom of the bearing is Δ_{IS} .

$$\Delta_{IS} = 1/2 (\Delta_{IS1} + \Delta_{IS2})$$

Among internal clearances between 2 rows of rollers symmetrical relative to the bearing center and outer ring, take that value measured between 2 rows of rollers of left side respectively as Δ_{IL1} and Δ_{IL2} and the internal clearance of left side of bearing as Δ_{IL} .

$$\Delta_{IL} = 1/2 (\Delta_{IL1} + \Delta_{IL2})$$

The internal clearances measured between 2 rows of rollers on the right side respectively as Δ_{IR1} and Δ_{IR2} . The internal clearance of right side of bearing is Δ_{IR} .

$$\Delta_{IR} = 1/2 (\Delta_{IR1} + \Delta_{IR2})$$

The internal bearing clearance (Δ_I) is given by the following equation:

$$\Delta_I = 1/2 (\Delta_{IS} + \Delta_{IL} + \Delta_{IR})$$

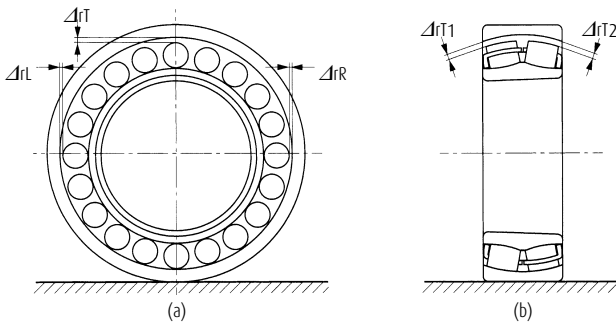

Fig. 2 Clearance Measurement Point (Bearing Outside Diameter: Larger Than 200 mm)

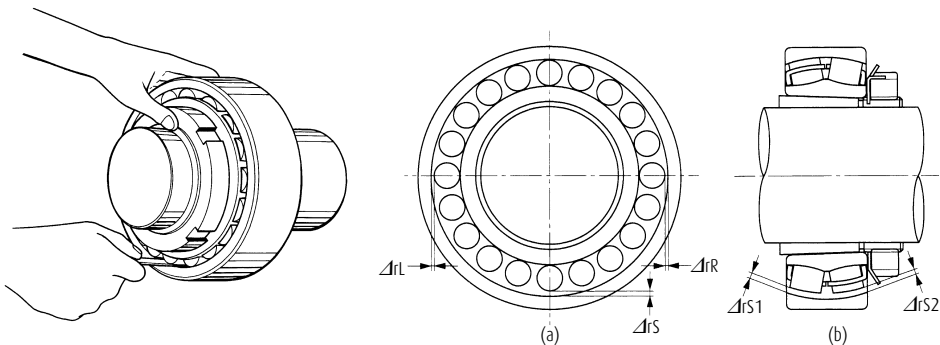

Fig. 3 Clearance Measurement Point

Spherical Roller Bearings

3. Temperature Equilibrium When Taking Measurements

To ensure accurate bearing measurement of the internal clearance or dimensions, the temperature of the measurement instrument and that of the components to be measured must be brought to the same temperature. Especially, if the bearing is mounted by using an oil heating tank or induction heater, then measure the internal clearance only after a complete cool down. For example, if a bearing is brought from the warehouse to the measurement place, the temperature of the stored bearing may still be high, thus, if the clearance or dimension were measured without confirming the bearing temperature, the measured value may be wrong.

For a large bearing with an outer ring outside diameter that is larger than 400 mm, if a clearance or dimension measurement is necessary, it is recommended to leave the unpacked bearing for about 24 hours on the surface plate, before making a clearance or dimension measurement. Put the end face of the bearing on a surface plate prior to measurement to ensure a measurement with both objects at the same temperature.

4. Clearance Adjustment When Mounting Bearing on a Tapered Shaft or Sleeve

Mount the bearing with its inner ring having a tapered bore to the tapered shaft or sleeve (adapter, removable sleeve). When pushing in the bearing to the tapered shaft or sleeve, the inner ring of bearing is widened resulting in increase of "interference" and reduction of internal clearance. It is important to give proper interference and internal clearance when mounting the bearing. Next, we show the reduction amount of the clearance to achieve the proper mounting.

(Mounting of spherical roller bearings having tapered bore Table 2)

When mounting a bearing, each time the bearing is pushed further onto the tapered shaft or sleeve, measure the variation of internal clearance and repeat the above procedure until the clearance reduction amount to the specified value listed in the Table 2 is attained. This procedure is called "Clearance adjustment" and when the clearance reduction amount is attained, the clearance necessary for bearing running is secured. The confirmation of the clearance reduction amount by measurement with a thickness gauge is very important. Depending on the method of clearance adjustment, the measured value obtained with the thickness gauge may not be correct. Therefore, the following corrective procedure must be executed.

1. In case to heat

When the temperatures of bearing and shaft are both at the same room temperature, measure again the clearance with the thickness gauge to confirm that the specified value is secured.

2. In case that a lock-washer is used as a turning stopper of the lock nut.

Prior to bending the tooth of the lock-washer into cutout of lock nut, measure again the clearance with the thickness gauge to confirm that the specified value is secured.

3. In case a hydraulic nut is used

After removal of the hydraulic nut, mount the lock nut and measure the clearance again to confirm that the specified value remains constant prior to stopping the turning.

4. In case an oil injection pump is used

Drop to zero the pressure of high pressure oil fed from the oil injection pump so that there is no pressure on bearing or sleeve fitted part. Next, measure the clearance with the thickness gauge to confirm that the specified value remains secured.

Radial Internal Clearance and Clearance Reduction Amount of the Bearing to be Mounted

- › When radial internal clearance is CN clearance (normal clearance) Perform the clearance adjustment while aiming at a middle value between minimum and maximum clearance reduction amount.
- › When radial internal clearance is C3 or C4 clearance Perform the clearance adjustment aiming at the maximum clearance reduction amount.

Internal Clearance Adjustment of Tapered-Bore Bearings

Perform the adjustment by measuring the clearance reduction amount with the thickness gauge.

1. For measurement position and measured point, refer to Section 2.(Page B280) of this manual.
2. To mount a bearing on a tapered shaft, perform each time when the bearing is pushed in by the lock nut, end plate, end cap or hydraulic nut.
3. When using an adapter sleeve, perform each time when the bearing is pushed in by the lock nut or hydraulic nut.
4. When using a removable sleeve, perform each time when the removable sleeve is pushed in by the lock nut or hydraulic nut.

When measuring the clearance during those operations, as the outer ring of bearing is hanging down from of rollers, turn the outer ring to right and left by one half to one full rotation while keeping the bearing in its correct posture.

Position one randomly chosen roller from each row of rollers to the exact bottom position. Then, insert the thickness gauge to an appropriate place depending on size of the outer ring outside diameter to measure the internal clearance. For the clearance adjustment, the measured value of each clearance measurement shall be recorded.

Table 2 Mounting of Spherical Roller Bearings with Tapered Bores

Units : mm

Bearing Bore Diameter d (mm)		Reduction in Radial Clearance		Axial Movement				Minimum Permissible Residual Clearance		
over	incl.	min.	max.	Taper 1:12		Taper 1:30		CN	C3	C4
				min.	max.	min.	max.			
30	40	0.025	0.030	0.40	0.45	—	—	0.010	0.025	0.035
40	50	0.030	0.035	0.45	0.55	—	—	0.015	0.030	0.045
50	65	0.030	0.035	0.45	0.55	—	—	0.025	0.035	0.060
65	80	0.040	0.045	0.60	0.70	—	—	0.030	0.040	0.075
80	100	0.045	0.055	0.70	0.85	1.75	2.15	0.035	0.050	0.085
100	120	0.050	0.060	0.75	0.90	1.9	2.25	0.045	0.065	0.110
120	140	0.060	0.070	0.90	1.1	2.25	2.75	0.055	0.080	0.130
140	160	0.065	0.080	1.0	1.3	2.5	3.25	0.060	0.100	0.150
160	180	0.070	0.090	1.1	1.4	2.75	3.5	0.070	0.110	0.170
180	200	0.080	0.100	1.3	1.6	3.25	4.0	0.070	0.110	0.190
200	225	0.090	0.110	1.4	1.7	3.5	4.25	0.080	0.130	0.210
225	250	0.100	0.120	1.6	1.9	4.0	4.75	0.090	0.140	0.230
250	280	0.110	0.140	1.7	2.2	4.25	5.5	0.100	0.150	0.250
280	315	0.120	0.150	1.9	2.4	4.75	6.0	0.110	0.160	0.280
315	355	0.140	0.170	2.2	2.7	5.5	6.75	0.120	0.180	0.300
355	400	0.150	0.190	2.4	3.0	6.0	7.5	0.130	0.200	0.330
400	450	0.170	0.210	2.7	3.3	6.75	8.25	0.140	0.220	0.360
450	500	0.190	0.240	3.0	3.7	7.5	9.25	0.160	0.240	0.390
500	560	0.210	0.270	3.4	4.3	8.5	11.0	0.170	0.270	0.410
560	630	0.230	0.300	3.7	4.8	9.25	12.0	0.200	0.310	0.460
630	710	0.260	0.330	4.2	5.3	10.5	13.0	0.220	0.330	0.520
710	800	0.280	0.370	4.5	5.9	11.5	15.0	0.240	0.390	0.590
800	900	0.310	0.410	5.0	6.6	12.5	16.5	0.280	0.430	0.660
900	1 000	0.340	0.460	5.5	7.4	14.0	18.5	0.310	0.470	0.730
1 000	1 120	0.370	0.500	5.9	8.0	15.0	20.0	0.360	0.530	0.800

Remarks

The values for reduction in radial internal clearance are for bearings with CN clearance. For bearings with C3 or C4 Clearance, the maximum values listed should be used for the reduction in radial internal clearance.



Spherical Roller Bearings

Bore Diameter 20 – 55 mm

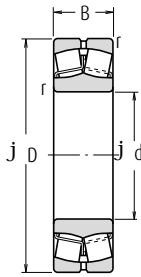

Cylindrical Bore
EA

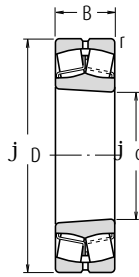

Tapered Bore
EA

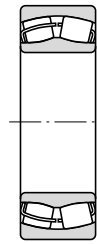

Without an Oil Groove or Holes
CD

Boundary Dimensions (mm)				Basic Load Ratings (N)		Thermal Reference Speed	Speeds (min ⁻¹)		Bearing									
d	D	B	r min.	C _r	C _{0r}		Limiting Speeds											
							Mechanical	Grease										
20	52	15	1.1	29 300	26 900	10 000	—	6 300	21304CDE4									
25	52	18	1.0	37 500	37 000	10 000	—	7 100	22205CE4									
										62	17	1.1	43 000	40 500	9 000	—	5 300	21305CDE4
30	62	20	1.0	50 000	50 000	8 500	—	6 000	22206CE4									
										72	19	1.1	55 000	54 000	7 500	—	4 500	21306CDE4
35	72	23	1.1	69 000	71 000	7 500	—	5 300	22207CE4									
										80	21	1.5	71 500	76 000	7 100	—	4 000	21307CDE4
40	80	23	1.1	113 000	99 000	7 100	12 000	6 700	22208EA4 ¹⁾									
										90	23	1.5	118 000	111 000	6 700	11 000	6 000	21308EA4 ¹⁾
										90	33	1.5	170 000	153 000	5 600	9 000	5 300	22308EA4 ¹⁾
45	85	23	1.1	118 000	111 000	6 300	11 000	6 000	22209EA4 ¹⁾									
										100	25	1.5	149 000	144 000	6 000	9 000	5 000	21309EA4 ¹⁾
										100	36	1.5	207 000	195 000	5 000	8 000	4 500	22309EA4 ¹⁾
50	90	23	1.1	124 000	119 000	6 000	9 500	5 600	22210EA4 ¹⁾									
										110	27	2.0	178 000	174 000	5 300	8 000	4 500	21310EA4 ¹⁾
										110	40	2.0	246 000	234 000	4 800	7 100	4 300	22310EA4 ¹⁾
55	100	25	1.5	149 000	144 000	5 300	9 000	5 300	22211EA4 ¹⁾									
										120	29	2.0	178 000	174 000	5 300	8 000	4 500	21311EA4 ¹⁾
										120	43	2.0	292 000	292 000	4 300	6 000	3 800	22311EA4 ¹⁾

Note (1) The suffix K represents bearings with tapered bores (taper 1 : 12).

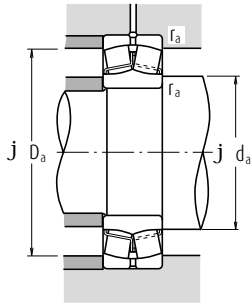

Dynamic Equivalent Load $P = XF_r + YF_a$

$F_a/F_r \leq e$		$F_a/F_r > e$	
X	Y	X	Y
1	Y_3	0.67	Y_3

Static Equivalent Load

$$P_0 = F_r + Y_0 F_a$$

The values of e , Y_2 , Y_3 and Y_0 are given in the table below.

Numbers	Abutment and Fillet Dimensions (mm)					Constant	Axial Load Factors			Mass (kg)
	Tapered Bore (1)		d_a	D_a	r_a		e	Y_2	Y_3	
	min.	max.	min.	max.	max.					approx.
21304CDKE4	27	28	45	42	1.0	0.31	3.2	2.1	2.1	0.17
22205CKE4	31	31	46	45	1.0	0.35	2.9	1.9	1.9	0.17
21305CDKE4	32	34	55	51	1.0	0.29	3.4	2.3	2.3	0.26
22206CKE4	36	37	56	54	1.0	0.33	3.1	2.1	2.0	0.27
21306CDKE4	37	40	65	59	1.0	0.28	3.6	2.4	2.3	0.39
22207CKE4	42	43	65	63	1.0	0.32	3.1	2.1	2.0	0.42
21307CDKE4	44	47	71	67	1.5	0.28	3.6	2.4	2.4	0.53
22208EAKE4*	47	49	73	70	1.0	0.28	3.6	2.4	2.4	0.50
21308EAKE4*	49	55	81	75	1.5	0.25	3.9	2.7	2.6	0.73
22308EAKE4*	49	52	81	77	1.5	0.35	2.8	1.9	1.9	0.98
22209EAKE4*	52	55	78	75	1.0	0.25	3.9	2.7	2.6	0.55
21309EAKE4*	54	65	91	89	1.5	0.23	4.3	2.9	2.8	0.96
22309EAKE4*	54	60	91	86	1.5	0.34	2.9	2.0	1.9	1.34
22210EAKE4*	57	60	83	81	1.0	0.24	4.3	2.9	2.8	0.61
21310EAKE4*	60	72	100	98	2.0	0.23	4.4	3.0	2.9	1.21
22310EAKE4*	60	64	100	93	2.0	0.35	2.8	1.9	1.9	1.78
22211EAKE4*	64	65	91	89	1.5	0.23	4.3	2.9	2.8	0.81
21311EAKE4*	65	72	110	98	2.0	0.23	4.4	3.0	2.9	1.58
22311EAKE4*	65	73	110	103	2.0	0.34	2.9	2.0	1.9	2.3

- Remarks**
- The bearings denoted by an asterisk (*) are NSKHPS bearings and an oil groove and holes are standard for them.
 - When making a selection of the recommended fit (Tolerance of shaft) on Page A164, in case of NSKHPS bearings, the conditions are different.
The segmentations are: Light Loads ($< 0.05C_r$); Normal Loads (0.05 to $0.10C_r$); and Heavy Loads ($> 0.10C_r$).
 - For the dimensions of adapters and withdrawal sleeves, refer to Pages **B376 - B377**, and **B384**.



Spherical Roller Bearings

Bore Diameter 60 – 90 mm

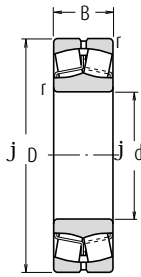

Cylindrical Bore
EA

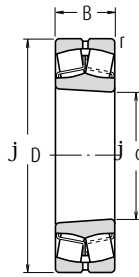

Tapered Bore
EA



Without an Oil Groove or Holes
CD

Boundary Dimensions (mm)				Basic Load Ratings (N)		Thermal Reference Speed	Speeds (min ⁻¹)		Bearing
d	D	B	r min.	C _r	C _{0r}		Limiting Speeds		
							Mechanical	Grease	
60	95	26.0	1.1	98 500	141 000	4 800	—	3 600	23012CE4
	110	28.0	1.5	178 000	174 000	5 300	8 000	4 800	22212EAE4 [†]
	130	31.0	2.1	238 000	244 000	4 800	6 700	3 800	21312EAE4 [†]
	130	46.0	2.1	340 000	340 000	4 000	5 600	3 600	22312EAE4 [†]
65	120	31.0	1.5	221 000	230 000	4 800	7 500	4 300	22213EAE4 [†]
	140	33.0	2.1	264 000	275 000	4 500	6 000	3 600	21313EAE4 [†]
	140	48.0	2.1	375 000	380 000	3 800	5 000	3 200	22313EAE4 [†]
70	125	31.0	1.5	225 000	232 000	4 500	7 100	4 000	22214EAE4 [†]
	150	35.0	2.1	310 000	325 000	4 300	5 600	3 200	21314EAE4 [†]
	150	51.0	2.1	425 000	435 000	3 600	4 800	3 000	22314EAE4 [†]
75	130	31.0	1.5	238 000	244 000	4 300	6 700	4 000	22215EAE4 [†]
	160	37.0	2.1	310 000	325 000	4 000	5 600	3 200	21315EAE4 [†]
	160	55.0	2.1	485 000	505 000	3 400	4 300	2 800	22315EAE4 [†]
80	140	33.0	2.0	264 000	275 000	4 000	6 000	3 600	22216EAE4 [†]
	170	39.0	2.1	355 000	375 000	3 800	4 800	3 000	21316EAE4 [†]
	170	58.0	2.1	540 000	565 000	3 200	3 800	2 600	22316EAE4 [†]
85	150	36.0	2.0	310 000	325 000	4 000	5 600	3 400	22217EAE4 [†]
	180	41.0	3.0	360 000	395 000	3 800	5 000	3 000	21317EAE4 [†]
	180	60.0	3.0	600 000	630 000	3 000	3 400	2 400	22317EAE4 [†]
90	160	40.0	2.0	360 000	395 000	3 800	5 000	3 200	22218EAE4 [†]
	160	52.4	2.0	340 000	490 000	2 800	—	1 800	23218CE4
	190	43.0	3.0	415 000	450 000	3 600	4 500	2 800	21318EAE4 [†]
190	64.0	3.0	665 000	705 000	2 800	3 000	2 400	22318EAE4 [†]	

Note (†) The suffix K represents bearings with tapered bores (taper 1 : 12).

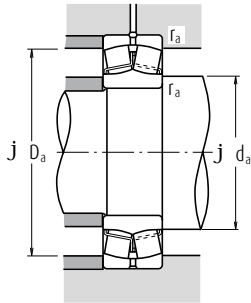

Dynamic Equivalent Load $P = XF_r + YF_a$

$F_a/F_r \leq e$		$F_a/F_r > e$	
X	Y	X	Y
1	Y_3	0.67	Y_3

Static Equivalent Load

$$P_0 = F_r + Y_0 F_a$$

The values of e , Y_2 , Y_3 and Y_0 are given in the table below.

Numbers	Abutment and Fillet Dimensions (mm)					Constant	Axial Load Factors			Mass (kg)
	d_a		D_a		r_a		e	Y_2	Y_3	
Tapered Bore (1)	min.	max.	min.	max.	max.	approx.				
23012CKE4	67	68	88	85	1	0.26	3.9	2.6	2.5	0.68
22212EAKE4*	69	72	101	98	1.5	0.23	4.4	3.0	2.9	1.1
21312EAKE4*	72	87	118	117	2	0.22	4.5	3.0	3.0	1.98
22312EAKE4*	72	79	118	111	2	0.34	3.0	2.0	1.9	2.89
22213EAKE4*	74	80	111	107	1.5	0.24	4.2	2.8	2.7	1.51
21313EAKE4*	77	94	128	126	2	0.22	4.6	3.1	3.0	2.45
22313EAKE4*	77	84	128	119	2	0.34	3.0	2.0	2.0	3.52
22214EAKE4*	79	84	116	111	1.5	0.23	4.3	2.9	2.8	1.58
21314EAKE4*	82	101	138	135	2	0.22	4.6	3.1	3.0	3.0
22314EAKE4*	82	91	138	129	2	0.33	3.0	2.0	2.0	4.28
22215EAKE4*	84	87	121	117	1.5	0.22	4.5	3.0	3.0	1.64
21315EAKE4*	87	101	148	134	2	0.22	4.6	3.1	3.0	3.64
22315EAKE4*	87	97	148	137	2	0.33	3.0	2.0	2.0	5.26
22216EAKE4*	90	94	130	126	2	0.22	4.6	3.1	3.0	2.01
21316EAKE4*	92	109	158	146	2	0.23	4.4	3.0	2.9	4.32
22316EAKE4*	92	103	158	145	2	0.33	3.0	2.0	2.0	6.23
22217EAKE4*	95	101	140	135	2	0.22	4.6	3.1	3.0	2.54
21317EAKE4*	99	108	166	142	2.5	0.24	4.3	2.9	2.8	5.2
22317EAKE4*	99	110	166	155	2.5	0.33	3.1	2.1	2.0	7.23
22218EAKE4*	100	108	150	142	2	0.24	4.3	2.9	2.8	3.3
23218CKE4	100	105	150	138	2	0.32	3.2	2.1	2.1	4.51
21318EAKE4*	104	115	176	152	2.5	0.24	4.3	2.9	2.8	6.1
22318EAKE4*	104	115	176	163	2.5	0.33	3.1	2.1	2.0	8.56

- Remarks**
- The bearings denoted by an asterisk (*) are NSKHPS bearings and an oil groove and holes are standard for them.
 - When making a selection of the recommended fit (Tolerance of shaft) on Page A164, in case of NSKHPS bearings, the conditions are different.
The segmentations are: Light Loads ($< 0.05C$); Normal Loads (0.05 to $0.10C$); and Heavy Loads ($> 0.10C$).
 - For the dimensions of adapters and withdrawal sleeves, refer to Pages B376 – B379, and B384 – B385.



Spherical Roller Bearings

Bore Diameter 95 – 110 mm

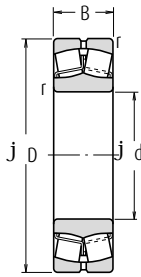

Cylindrical Bore
EA

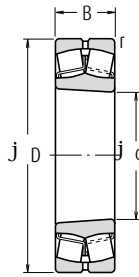

Tapered Bore
EA



Without an Oil Groove or Holes
CD

Boundary Dimensions (mm)				Basic Load Ratings (N)		Thermal Reference Speed	Speeds (min ⁻¹)		Bearing
d	D	B	r min.	C _r	C _{0r}		Limiting Speeds		
							Mechanical	Grease	
95	170	43.0	2.1	415 000	450 000	3 800	4 500	3 000	2219EAE4 [®]
	170	55.6	2.1	370 000	525 000	2 600	—	1 700	23219CAME4
	200	45.0	3.0	430 000	435 000	3 600	—	1 500	21319CAME4 [®]
	200	45.0	3.0	430 000	435 000	3 400	—	1 500	21319CE4
	200	67.0	3.0	735 000	780 000	2 600	3 000	2 200	22319EAE4 [®]
100	150	37.0	1.5	212 000	335 000	3 200	—	2 200	23020CDE4
	150	50.0	1.5	276 000	470 000	2 800	—	1 800	24020CE4
	165	52.0	2.0	345 000	530 000	2 800	—	1 700	23120CE4
	165	65.0	2.0	345 000	535 000	2 400	—	1 700	24120CAME4
	180	46.0	2.1	455 000	490 000	3 600	4 300	2 800	22220EAE4 [®]
	180	60.3	2.1	525 000	605 000	2 800	3 800	1 600	23220CAME4 [®]
	180	60.3	2.1	525 000	605 000	2 600	—	1 600	23220CE4
	215	47.0	3.0	495 000	485 000	3 400	4 500	1 400	21320CAME4 [®]
	215	47.0	3.0	495 000	485 000	3 200	—	1 400	21320CE4
	215	73.0	3.0	750 000	785 000	2 600	3 400	1 700	22320CAME4(2) [®]
110	170	45.0	2.0	293 000	465 000	3 200	—	2 000	23022CDE4
	170	60.0	2.0	380 000	645 000	2 600	—	1 600	24022CE4
	180	56.0	2.0	480 000	630 000	3 200	4 000	1 600	23122CAME4 [®]
	180	56.0	2.0	480 000	630 000	2 600	—	1 600	23122CE4
	180	69.0	2.0	575 000	750 000	2 200	3 400	1 600	24122CAME4 [®]
	180	69.0	2.0	575 000	750 000	2 000	—	1 600	24122CE4
	200	53.0	2.1	605 000	645 000	3 400	3 400	2 600	22222EAE4 [®]
	200	69.8	2.1	645 000	760 000	2 600	3 400	1 500	23222CAME4 [®]
	200	69.8	2.1	645 000	760 000	2 200	—	1 500	23222CE4
	240	50.0	3.0	450 000	545 000	3 000	—	1 300	21322CAE4
	240	50.0	3.0	565 000	545 000	3 000	4 300	1 300	21322CAME4 [®]
	240	80.0	3.0	1 030 000	1 120 000	2 200	—	1 500	22322EAE4 [®]
	240	80.0	3.0	925 000	980 000	2 200	3 000	1 500	22322CAME4(2) [®]

Notes

- (1) The suffix K or K30 represents bearings with tapered bores (taper 1 : 12 or 1 : 30).
- (2) EA is also available. Load rating of EA is around 10% higher than CAM's, please consult NSK.

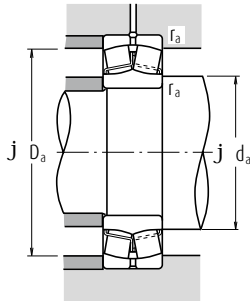

Dynamic Equivalent Load $P = X F_r + Y F_a$

$F_a/F_r \leq e$		$F_a/F_r > e$	
X	Y	X	Y
1	Y_3	0.67	Y_3

Static Equivalent Load

$$P_0 = F_r + Y_0 F_a$$

The values of e , Y_2 , Y_3 and Y_0 are given in the table below.

Numbers	Abutment and Fillet Dimensions (mm)					Constant	Axial Load Factors			Mass (kg)
	d_a		D_a		r_a		e	Y_2	Y_3	
Tapered Bore (1)	min.	max.	min.	max.	max.	approx.				
22219EAKE4*	107	115	158	152	2	0.24	4.3	2.9	2.8	4.04
23219CAMKE4	107	—	158	146	2	0.32	3.1	2.1	2.0	5.33
23219CAMKE4	109	127	186	172	2.5	0.22	4.6	3.1	3.0	6.92
21319CKE4	109	127	186	172	2.5	0.22	4.6	3.1	3.0	6.92
22319EAKE4	109	121	186	172	2.5	0.33	3.1	2.1	2.0	9.91
23020CDKE4	109	112	141	136	1.5	0.22	4.6	3.1	3.0	2.31
24020CK30E4	109	110	141	132	1.5	0.30	3.4	2.3	2.2	3.08
23120CKE4	110	113	155	144	2	0.30	3.4	2.3	2.2	4.38
24120CAMK30E4	110	—	155	143	2	0.35	2.9	1.9	1.9	5.42
22220EAKE4*	112	119	168	160	2	0.24	4.3	2.9	2.8	4.84
23220CAMKE4*	112	118	168	155	2	0.32	3.2	2.1	2.1	6.6
23220CKE4	112	118	168	155	2	0.32	3.2	2.1	2.1	6.6
21320CAMKE4*	114	133	201	184	2.5	0.23	4.4	3.0	2.9	8.46
21320CKE4	114	133	201	184	2.5	0.21	4.7	3.2	3.1	8.46
22320CAMKE4(2)*	114	130	201	184	2.5	0.35	2.9	1.9	1.9	12.7
23022CDKE4	120	124	160	153	2	0.24	4.2	2.8	2.8	3.76
24022CK30E4	120	121	160	148	2	0.32	3.1	2.1	2.1	4.96
23122CAMKE4*	120	127	170	158	2	0.28	3.5	2.4	2.3	5.7
23122CKE4	120	127	170	158	2	0.29	3.6	2.4	2.3	5.8
24122CAMK30E4*	120	123	170	154	2	0.36	2.8	1.9	1.8	6.84
24122CK30E4	120	123	170	154	2	0.37	2.9	1.9	1.8	6.85
22222EAKE4*	122	129	188	178	2	0.25	4.0	2.7	2.6	6.99
23222CAMKE4*	122	130	188	170	2	0.34	3.0	2.0	1.9	9.54
23222CKE4	122	130	188	170	2	0.35	3.1	2.1	1.10	9.55
21322CAKE4	124	—	226	206	2.5	0.22	4.6	3.1	3.0	11.2
21322CAMKE4*	124	—	226	206	2.5	0.22	4.6	3.1	3.0	11.2
22322EAKE4*	124	145	226	206	2.5	0.33	3.1	2.1	2.0	17.6
22322CAMKE4(2)*	124	145	226	206	2.5	0.33	3.1	2.1	2.0	17.6

- Remarks**
- The bearings denoted by an asterisk (*) are NSKHPS bearings and an oil groove and holes are standard for them.
 - When making a selection of the recommended fit (Tolerance of Shaft) on Page A164, in case of NSKHPS bearings, the conditions are different.
The segmentations are: Light Loads ($< 0.05C_0$); Normal Loads (0.05 to $0.10C_0$); and Heavy Loads ($> 0.10C_0$).
 - For the dimensions of adapters and withdrawal sleeves, refer to Pages **B379** and **B385**.

Spherical Roller Bearings

Bore Diameter 120 – 130 mm

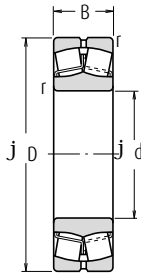

Cylindrical Bore
EA

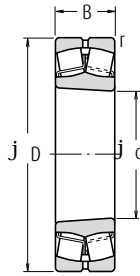

Tapered Bore
EA



Without an Oil Groove or Holes
CD

Boundary Dimensions (mm)				Basic Load Ratings (N)		Thermal Reference Speed	Speeds (min ⁻¹)		Bearing	
d	D	B	r min.	C _r	C _{0r}		Limiting Speeds			
							Mechanical	Grease		
120	180	46.0	2.0	395 000	525 000	3 200	4 500	1 800	23024CAME4 [⊕]	
	180	46.0	2.0	395 000	525 000	2 800	—	1 800	23024CDE4	
	180	60.0	2.0	480 000	680 000	2 600	3 600	1 500	24024CAME4 [⊕]	
	180	60.0	2.0	480 000	680 000	2 400	—	1 500	24024CE4	
	200	62.0	2.0	580 000	720 000	2 800	3 600	1 400	23124CAME4 [⊕]	
	200	62.0	2.0	580 000	720 000	2 400	—	1 400	23124CE4	
	200	80.0	2.0	695 000	905 000	2 000	3 000	1 400	24124CAME4 [⊕]	
	200	80.0	2.0	695 000	905 000	1 800	—	1 400	24124CE4	
	215	58.0	2.1	685 000	765 000	3 200	3 000	2 400	22224EAE4 [⊕]	
	215	76.0	2.1	790 000	970 000	2 200	3 000	1 300	23224CAME4 [⊕]	
	215	76.0	2.1	790 000	970 000	2 000	—	1 300	23224CE4	
	260	86.0	3.0	1 190 000	1 320 000	—	—	—	22324EAE4 [⊕]	
	260	86.0	3.0	1 060 000	1 120 000	2 000	2 800	1 400	22324CAME4 ⁽²⁾ ⊕	
	130	200	52.0	2.0	500 000	655 000	3 000	3 800	1 700	23026CAME4 [⊕]
		200	52.0	2.0	500 000	655 000	2 800	—	1 700	23026CDE4
		200	69.0	2.0	620 000	865 000	2 200	3 200	1 400	24026CAME4 [⊕]
200		69.0	2.0	620 000	865 000	2 200	—	1 400	24026CE4	
210		64.0	2.0	630 000	825 000	2 200	3 400	1 300	23126CAME4 [⊕]	
210		64.0	2.0	630 000	825 000	2 200	—	1 300	23126CE4	
210		80.0	2.0	735 000	1 010 000	1 800	2 800	1 300	24126CAME4 [⊕]	
210		80.0	2.0	735 000	1 010 000	1 600	—	1 300	24126CE4	
230		64.0	3.0	820 000	940 000	2 800	2 600	2 200	22226EAE4 [⊕]	
230		80.0	3.0	875 000	1 080 000	2 000	2 800	1 200	23226CAME4 [⊕]	
230		80.0	3.0	875 000	1 080 000	1 800	—	1 200	23226CE4	
280		93.0	4.0	1 240 000	1 350 000	1 800	2 600	1 300	22326CAME4 [⊕]	
280		93.0	4.0	1 240 000	1 350 000	1 900	—	1 300	22326CE4	

Notes

- (1) The suffix K or K30 represents bearings with tapered bores (taper 1 : 12 or 1 : 30).
 (2) EA is also available. Load rating of EA is around 10% higher than CAM's, please consult NSK.

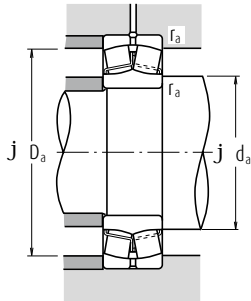

Dynamic Equivalent Load $P = XF_r + YF_a$

$F_a/F_r \leq e$		$F_a/F_r > e$	
X	Y	X	Y
1	Y_3	0.67	Y_3

Static Equivalent Load

$$P_0 = F_r + Y_0 F_a$$

The values of e , Y_2 , Y_3 and Y_0 are given in the table below.

Numbers	Abutment and Fillet Dimensions (mm)					Constant	Axial Load Factors			Mass (kg)
	d_a		D_a		r_a		e	Y_2	Y_3	
Tapered Bore (!)	min.	max.	min.	max.	max.	approx.				
23024CAMKE4 *	130	134	170	163	2	0.22	4.5	3.0	2.9	4.11
23024CDKE4	130	134	170	163	2	0.22	4.5	3.0	2.9	4.11
24024CAMK30E4 *	130	131	170	158	2	0.32	3.2	2.1	2.1	5.33
24024CK30E4	130	131	170	158	2	0.32	3.2	2.1	2.1	5.33
23124CAMKE4 *	130	138	190	175	2	0.29	3.5	2.4	2.3	7.85
23124CKE4	130	138	190	175	2	0.29	3.5	2.4	2.3	7.85
24124CAMK30E4 *	130	136	190	171	2	0.37	2.7	1.8	1.8	10
24124CK30E4	130	136	190	171	2	0.37	2.7	1.8	1.8	10
22224EAKE4 *	132	142	203	190	2	0.25	3.9	2.7	2.6	8.8
23224CAMKE4 *	132	140	203	182	2	0.35	2.9	1.9	1.9	12.1
23224CKE4	132	140	203	182	2	0.34	2.9	2.0	1.9	12.1
22324EAKE4 *	134	157	246	222	2.5	0.32	3.1	2.1	2.0	22.2
22324CAMKE4(2) *	134	157	246	222	2.5	0.32	3.1	2.1	2.0	22.2
23026CAMKE4 *	140	147	190	180	2	0.23	4.3	2.9	2.8	5.98
23026CDKE4	140	147	190	180	2	0.23	4.3	2.9	2.8	5.98
24026CAMK30E4 *	140	143	190	175	2	0.31	3.2	2.2	2.1	7.84
24026CK30E4	140	143	190	175	2	0.31	3.2	2.2	2.1	7.84
23126CAMKE4 *	140	149	200	184	2	0.28	3.6	2.4	2.4	8.69
23126CKE4	140	149	200	184	2	0.28	3.6	2.4	2.4	8.69
24126CAMK30E4 *	140	146	200	180	2	0.37	2.7	1.8	1.8	10.7
24126CK30E4	140	146	200	180	2	0.35	2.9	1.9	1.9	10.7
22226EAKE4 *	144	152	216	204	2.5	0.26	3.8	2.6	2.5	11
23226CAMKE4 *	144	150	216	196	2.5	0.34	2.9	2.0	1.9	14.3
23226CKE4	144	150	216	196	2.5	0.34	2.9	2.0	1.9	14.3
22326CAMKE4 *	148	166	262	236	3	0.34	2.9	2.0	1.9	28.1
22326CKE4	148	166	262	236	3	0.34	2.9	2.0	1.9	28.1

- Remarks**
- The bearings denoted by an asterisk (*) are NSKHPS bearings and an oil groove and holes are standard for them.
 - When making a selection of the recommended fit (Tolerance of Shaft) on Page A164, in case of NSKHPS bearings, the conditions are different.
The segmentations are: Light Loads ($< 0.05C$); Normal Loads (0.05 to $0.10C$); and Heavy Loads ($> 0.10C$).
 - For the dimensions of adapters and withdrawal sleeves, refer to Pages **B380** and **B385**.

Spherical Roller Bearings

Bore Diameter 140 – 150 mm

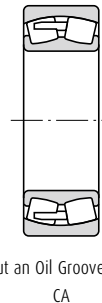
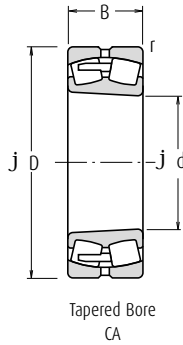
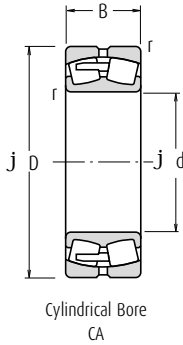

Boundary Dimensions (mm)				Basic Load Ratings (N)		Thermal Reference Speed	Speeds (min ⁻¹)		Bearing	
d	D	B	r min.	C _r	C _{0r}		Limiting Speeds			
							Mechanical	Grease		
140	210	53	2	525 000	715 000	2 800	3 800	1 600	23028CAME4 [†]	
	210	53	2	420 000	715 000	2 400	—	1 600	23028CDE4	
	210	69	2	635 000	905 000	2 200	3 000	1 300	24028CAME4 [†]	
	210	69	2	525 000	945 000	2 000	—	1 300	24028CE4	
	225	68	2.1	725 000	945 000	2 400	3 200	1 200	23128CAME4 [†]	
	225	68	2.1	580 000	945 000	2 000	—	1 200	23128CE4	
	225	85	2.1	835 000	1 160 000	1 600	2 600	1 200	24128CAME4 [†]	
	225	85	2.1	670 000	1 160 000	1 500	—	1 200	24128CE4	
	250	68	3	835 000	945 000	2 600	3 200	1 400	22228CAME4 [†]	
	250	68	3	645 000	930 000	2 400	—	1 400	22228CDE4	
	250	88	3	1 040 000	1 300 000	1 800	2 600	1 100	23228CAME4 [†]	
	250	88	3	835 000	1 300 000	1 600	—	1 100	23228CE4	
	300	102	4	1 450 000	1 590 000	1 700	2 400	1 200	22328CAME4 [†]	
	300	102	4	1 160 000	1 590 000	1 700	—	1 200	22328CE4	
	150	225	56	2.1	590 000	815 000	2 600	3 600	1 400	23030CAME4 [†]
		225	56	2.1	470 000	815 000	2 200	—	1 400	23030CDE4
225		75	2.1	740 000	1 090 000	1 900	3 000	1 200	24030CAME4 [†]	
225		75	2.1	590 000	1 090 000	1 800	—	1 200	24030CE4	
250		80	2.1	905 000	1 180 000	2 200	2 800	1 100	23130CAME4 [†]	
250		80	2.1	725 000	1 180 000	1 800	—	1 100	23130CE4	
250		100	2.1	1 070 000	1 450 000	1 400	2 400	1 100	24130CAME4 [†]	
250		100	2.1	890 000	1 530 000	1 300	—	1 100	24130CE4	
270		73	3	955 000	1 120 000	2 400	3 000	1 300	22230CAME4 [†]	
270		73	3	765 000	1 120 000	2 200	—	1 300	22230CDE4	
270		96	3	1 220 000	1 560 000	1 700	2 400	1 100	23230CAME4 [†]	
270		96	3	975 000	1 560 000	1 500	—	1 100	23230CE4	
320		108	4	1 530 000	1 690 000	1 600	2 200	1 100	22330CAME4 [†]	

Note (†) The suffix K or K30 represents bearings with tapered bores (taper 1 : 12 or 1 : 30).

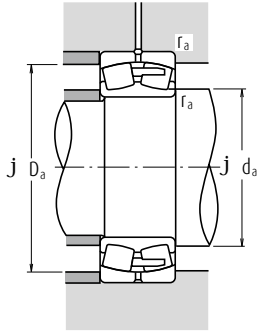

Dynamic Equivalent Load $P = XF_r + YF_a$

$F_a/F_r \leq e$		$F_a/F_r > e$	
X	Y	X	Y
1	Y_3	0.67	Y_3

Static Equivalent Load

$$P_0 = F_r + Y_0 F_a$$

The values of e , Y_2 , Y_3 and Y_0 are given in the table below.

Numbers	Abutment and Fillet Dimensions (mm)					Constant	Axial Load Factors			Mass (kg)
	d_a		D_a		r_a		e	Y_2	Y_3	
Tapered Bore (!)	min.	max.	min.	max.		approx.				
23028CAMKE4 *	150	157	200	190	2	0.22	4.5	3.0	2.9	6.49
23028CDKE4	150	157	200	190	2	0.22	4.5	3.0	2.9	6.49
24028CAMK30E4 *	150	154	200	186	2	0.31	3.4	2.3	2.2	8.37
24028CK30E4	150	154	200	186	2	0.29	3.4	2.3	2.2	8.37
23128CAMKE4 *	152	158	213	198	2	0.28	3.6	2.4	2.3	10.5
23128CKE4	152	158	213	198	2	0.28	3.6	2.4	2.3	10.5
24128CAMK30E4 *	152	156	213	193	2	0.37	2.7	1.8	1.8	13
24128CK30E4	152	156	213	193	2	0.35	2.9	1.9	1.9	13
22228CAMKE4 *	154	167	236	221	2.5	0.26	3.9	2.6	2.5	14.5
22228CDKE4	154	167	236	219	2.5	0.25	4.0	2.7	2.6	14.5
23228CAMKE4 *	154	163	236	213	2.5	0.35	2.9	1.9	1.9	18.8
23228CKE4	154	163	236	213	2.5	0.35	2.9	1.9	1.9	18.8
22328CAMKE4 *	158	177	282	253	3	0.35	2.9	1.9	1.9	35.4
22328CKE4	158	177	282	253	3	0.35	2.9	1.9	1.9	35.4
23030CAMKE4 *	162	168	213	203	2	0.22	4.6	3.1	3.0	7.9
23030CDKE4	162	168	213	203	2	0.22	4.6	3.1	3.0	7.9
24030CAMK30E4 *	162	165	213	198	2	0.30	3.4	2.3	2.2	10.5
24030CK30E4	162	165	213	198	2	0.30	3.4	2.3	2.2	10.5
23130CAMKE4 *	162	174	238	218	2	0.30	3.4	2.3	2.2	15.8
23130CKE4	162	174	238	218	2	0.30	3.4	2.3	2.2	15.8
24130CAMK30E4 *	162	169	238	212	2	0.38	2.6	1.8	1.7	19.8
24130CK30E4	162	169	238	212	2	0.38	2.6	1.8	1.7	19.8
22230CAMKE4 *	164	179	256	236	2.5	0.26	3.9	2.6	2.5	18.4
22230CDKE4	164	179	256	236	2.5	0.26	3.9	2.6	2.5	18.4
23230CAMKE4 *	164	176	256	230	2.5	0.35	2.9	1.9	1.9	24.2
23230CKE4	164	176	256	230	2.5	0.35	2.9	1.9	1.9	24.2
22330CAMKE4 *	164	—	302	270	3	0.35	2.9	1.9	1.9	41.5

- Remarks**
1. The bearings denoted by an asterisk (*) are NSKHPS bearings and an oil groove and holes are standard for them.
 2. When making a selection of the recommended fit (Tolerance of shaft) on Page A164, in case of NSKHPS bearings, the conditions are different.
The segmentations are: Light Loads ($< 0.05C_r$); Normal Loads (0.05 to $0.10C_r$); and Heavy Loads ($> 0.10C_r$).
 3. For the dimensions of adapters and withdrawal sleeves, refer to Pages **B380** and **B386**.

Spherical Roller Bearings

Bore Diameter 160 – 170 mm

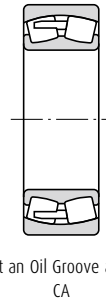
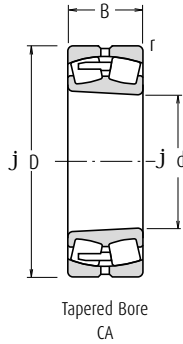
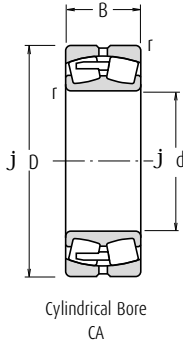

Boundary Dimensions (mm)				Basic Load Ratings (N)		Thermal Reference Speed	Speeds (min ⁻¹)		Bearing
d	D	B	r min.	C _r	C _{0r}		Limiting Speeds		
							Mechanical	Grease	
160	220	45	2	450 000	675 000	3 000	3 200	1 400	23932CAME4 *
	220	45	2	360 000	675 000	3 000	—	1 400	23932CAE4
	240	60	2.1	675 000	955 000	2 400	3 200	1 300	23032CAME4 *
	240	60	2.1	540 000	955 000	2 200	—	1 300	23032CE4
	240	80	2.1	845 000	1 260 000	1 800	2 800	1 100	24032CAME4 *
	240	80	2.1	680 000	1 260 000	1 700	—	1 100	24032CE4
	270	86	2.1	1 070 000	1 400 000	2 000	2 600	1 000	23132CAME4 *
	270	86	2.1	855 000	1 400 000	1 700	—	1 000	23132CE4
	270	109	2.1	1 240 000	1 670 000	1 300	2 200	1 000	24132CAME4 *
	270	109	2.1	1 040 000	1 760 000	1 200	—	1 000	24132CE4
	290	80	3	1 140 000	1 320 000	2 200	2 800	1 200	22232CAME4 *
	290	80	3	910 000	1 320 000	2 000	—	1 200	22232CE4
	290	104	3	1 370 000	1 770 000	1 500	2 200	1 000	23232CAME4 *
	290	104	3	1 100 000	1 770 000	1 500	—	1 000	23232CE4
	340	114	4	1 700 000	1 900 000	1 400	2 200	1 100	22332CAME4 *
	170	230	45	2	450 000	680 000	3 000	3 600	1 400
260		67	2.1	795 000	1 090 000	2 200	3 000	1 200	23034CAME4 *
260		67	2.1	640 000	1 090 000	2 000	—	1 200	23034CE4
260		90	2.1	1 030 000	1 520 000	1 600	2 400	1 000	24034CAME4 *
260		90	2.1	825 000	1 520 000	1 500	—	1 000	24034CE4
280		88	2.1	1 180 000	1 570 000	1 800	2 600	1 000	23134CAME4 *
280		88	2.1	940 000	1 570 000	1 500	—	1 000	23134CE4
280		109	2.1	1 280 000	1 770 000	1 200	2 200	1 000	24134CAME4 *
280		109	2.1	1 080 000	1 860 000	1 100	—	1 000	24134CE4
310		86	4	1 240 000	1 500 000	2 000	2 600	1 100	22234CAME4 *
310		86	4	990 000	1 500 000	1 800	—	1 100	22234CE4
310		110	4	1 500 000	1 910 000	1 400	2 200	900	23234CAME4 *
310	110	4	1 200 000	1 910 000	1 300	—	900	23234CE4	
360	120	4	1 970 000	2 110 000	1 300	2 000	1 000	22334CAME4 *	

Note (i) The suffix K or K30 represents bearings with tapered bores (taper 1 : 12 or 1 : 30).

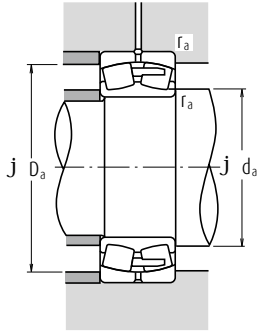

Dynamic Equivalent Load $P = XF_r + YF_a$

$F_a/F_r \leq e$		$F_a/F_r > e$	
X	Y	X	Y
1	Y_3	0.67	Y_3

Static Equivalent Load

$$P_0 = F_r + Y_0 F_a$$

The values of e , Y_2 , Y_3 and Y_0 are given in the table below.

Numbers	Abutment and Fillet Dimensions (mm)					Constant	Axial Load Factors			Mass (kg)
	d_a		D_a		r_a		e	Y_2	Y_3	
Tapered Bore (!)	min.	max.	max.	min.	max.	approx.				
23932CAMKE4 *	170	—	210	203	2	0.18	5.6	3.8	3.7	4.97
23932CAKE4	170	—	210	203	2	0.18	5.6	3.8	3.7	4.97
23032CAMKE4 *	172	179	228	216	2	0.22	4.5	3.0	2.9	9.66
23032CDKE4	172	179	228	216	2	0.22	4.5	3.0	2.9	9.66
24032CAMK30E4 *	172	177	228	212	2	0.30	3.4	2.3	2.2	12.7
24032CK30E4	172	177	228	212	2	0.30	3.4	2.3	2.2	12.7
23132CAMKE4 *	172	185	258	234	2	0.30	3.4	2.3	2.2	20.3
23132CKE4	172	185	258	234	2	0.30	3.4	2.3	2.2	20.3
24132CAMK30E4 *	172	179	258	229	2	0.39	2.6	1.7	1.7	25.4
24132CK30E4	172	179	258	229	2	0.39	2.6	1.7	1.7	25.4
22232CAMKE4 *	174	190	276	255	2.5	0.26	3.8	2.6	2.5	23.1
22232CDKE4	174	190	276	255	2.5	0.26	3.8	2.6	2.5	23.1
23232CAMKE4 *	174	189	276	245	2.5	0.34	2.9	2.0	1.9	30.5
23232CKE4	174	189	276	245	2.5	0.34	2.9	2.0	1.9	30.5
22332CAMKE4 *	178	—	322	287	3	0.35	2.9	1.9	1.9	49.3
23934CAMKE4 *	180	—	220	213	2	0.17	5.8	3.9	3.8	5.38
23034CAMKE4 *	182	191	248	233	2	0.23	4.3	2.9	2.8	13
23034CDKE4	182	191	248	233	2	0.23	4.3	2.9	2.8	13
24034CAMK30E4 *	182	188	248	228	2	0.31	3.2	2.2	2.1	17.3
24034CK30E4	182	188	248	228	2	0.31	3.2	2.2	2.1	17.3
23134CAMKE4 *	182	194	268	245	2	0.29	3.5	2.3	2.3	21.8
23134CKE4	182	194	268	245	2	0.29	3.5	2.3	2.3	21.8
24134CAMK30E4 *	182	190	268	239	2	0.38	2.7	1.8	1.7	26.6
24134CK30E4	182	190	268	239	2	0.37	2.7	1.8	1.8	26.6
22234CAMKE4 *	188	206	292	270	3	0.26	3.8	2.6	2.5	28.8
22234CDKE4	188	206	292	270	3	0.26	3.8	2.6	2.5	28.8
23234CAMKE4 *	188	201	292	261	3	0.35	2.9	1.9	1.9	36.4
23234CKE4	188	201	292	261	3	0.34	2.9	2.0	1.9	36.4
22334CAMKE4 *	188	—	342	304	3	0.35	2.9	1.9	1.9	57.9

- Remarks**
- The bearings denoted by an asterisk (*) are NSKHPS bearings and an oil groove and holes are standard for them.
 - When making a selection of the recommended fit (Tolerance of shaft) on Page A164, in case of NSKHPS bearings, the conditions are different.
The segmentations are: Light Loads ($< 0.05C$); Normal Loads (0.05 to $0.10C$); and Heavy Loads ($> 0.10C$).
 - For the dimensions of adapters and withdrawal sleeves, refer to Pages **B380** and **B386**.

Spherical Roller Bearings

Bore Diameter 180 – 190 mm

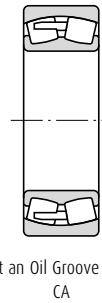
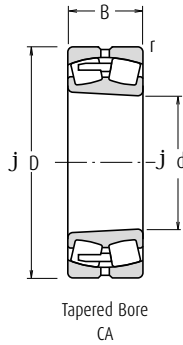
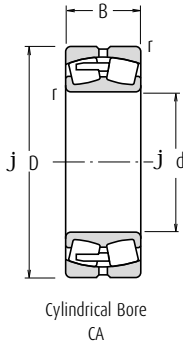

Boundary Dimensions (mm)				Basic Load Ratings (N)		Thermal Reference Speed	Speeds (min ⁻¹)		Bearing	
d	D	B	r min.	C _r	C _{0r}		Limiting Speeds			
							Mechanical	Grease		
180	250	52	2	470 000	890 000	2 600	—	1 200	23936CAE4	
	250	52	2	590 000	890 000	2 600	3 000	1 200	23936CAME4 *	
	280	74	2.1	935 000	1 270 000	2 000	2 800	1 200	23036CAME4 *	
	280	74	2.1	750 000	1 270 000	1 900	—	1 200	23036CDE4	
	280	100	2.1	1 210 000	1 750 000	1 500	2 200	950	24036CAME4 *	
	280	100	2.1	965 000	1 750 000	1 400	—	950	24036CE4	
	300	96	3	1 320 000	1 760 000	1 700	2 200	900	23136CAME4 *	
	300	96	3	1 050 000	1 760 000	1 400	—	900	23136CE4	
	300	118	3	1 490 000	2 040 000	1 100	2 000	900	24136CAME4 *	
	300	118	3	1 190 000	2 040 000	1 000	—	900	24136CE4	
	320	86	4	1 280 000	1 540 000	2 000	2 600	1 100	22236CAME4 *	
	320	86	4	1 020 000	1 540 000	1 800	—	1 100	22236CDE4	
	320	112	4	1 620 000	2 110 000	1 300	2 000	850	23236CAME4 *	
	320	112	4	1 300 000	2 110 000	1 200	—	850	23236CE4	
	380	126	4	2 170 000	2 340 000	1 200	2 000	950	22336CAME4 *	
	190	260	52	2	575 000	875 000	2 600	3 000	1 200	23938CAME4 *
		290	75	2.1	970 000	1 350 000	2 000	2 600	1 100	23038CAME4 *
		290	100	2.1	1 220 000	1 840 000	1 400	2 200	900	24038CAME4 *
290		100	2.1	975 000	1 840 000	1 400	—	900	24038CE4	
320		104	3	1 480 000	2 020 000	1 600	2 200	850	23138CAME4 *	
320		104	3	1 190 000	2 020 000	1 300	—	850	23138CE4	
320		128	3	1 710 000	2 330 000	1 000	1 900	850	24138CAME4 *	
320		128	3	1 370 000	2 330 000	950	—	850	24138CE4	
340		92	4	1 420 000	1 730 000	1 800	2 400	1 000	22238CAME4 *	
340		120	4	1 800 000	2 350 000	1 200	1 900	800	23238CAME4 *	
340		120	4	1 440 000	2 350 000	1 100	—	800	23238CE4	
400		132	5	2 370 000	2 590 000	1 200	1 900	900	22338CAME4 *	

Note (*) The suffix K or K30 represents bearings with tapered bores (taper 1 : 12 or 1 : 30).

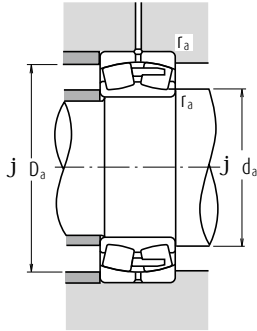

Dynamic Equivalent Load $P = X F_r + Y F_a$

$F_a/F_r \leq e$		$F_a/F_r > e$	
X	Y	X	Y
1	Y_3	0.67	Y_3

Static Equivalent Load

$$P_0 = F_r + Y_0 F_a$$

The values of e , Y_2 , Y_3 and Y_0 are given in the table below.

Numbers	Abutment and Fillet Dimensions (mm)					Constant	Axial Load Factors			Mass (kg)
	d_a		D_a		r_a		e	Y_2	Y_3	
Tapered Bore (!)	min.	max.	max.	min.	max.	approx.				
23936CAKE4	190	—	240	230	2	0.18	5.5	3.7	3.6	7.64
23936CAMKE4*	190	—	240	230	2	0.18	5.5	3.7	3.6	7.64
23036CAMKE4*	192	202	268	249	2	0.24	4.2	2.8	2.8	17.1
23036CDKE4	192	202	268	249	2	0.24	4.2	2.8	2.8	17.1
24036CAMK30E4*	192	200	268	245	2	0.32	3.1	2.1	2.0	22.7
24036CK30E4	192	200	268	245	2	0.32	3.1	2.1	2.0	22.7
23136CAMKE4*	194	206	286	260	2.5	0.31	3.3	2.2	2.2	27.5
23136CKE4	194	206	286	260	2.5	0.30	3.4	2.3	2.2	27.5
24136CAMK30E4*	194	202	286	255	2.5	0.37	2.7	1.8	1.8	33.1
24136CK30E4	194	202	286	255	2.5	0.37	2.7	1.8	1.8	33.1
22236CAMKE4*	198	212	302	278	3	0.26	3.9	2.6	2.6	30.2
22236CDKE4	198	212	302	278	3	0.26	3.9	2.6	2.6	30.2
23236CAMKE4*	198	211	302	274	3	0.35	2.9	1.9	1.9	38.9
23236CKE4	198	211	302	274	3	0.33	3.0	2.0	2.0	38.9
22336CAMKE4*	198	—	362	322	3	0.34	2.9	2.0	1.9	67
23938CAMKE4*	200	—	250	240	2	0.18	5.7	3.8	3.7	8.03
23038CAMKE4*	202	—	278	261	2	0.24	4.2	2.8	2.8	17.6
24038CAMK30E4*	202	210	278	253	2	0.32	3.1	2.1	2.0	24
24038CK30E4	202	210	278	253	2	0.31	3.2	2.2	2.1	24
23138CAMKE4*	204	219	306	276	2.5	0.31	3.2	2.2	2.1	34.5
23138CKE4	204	219	306	276	2.5	0.31	3.3	2.2	2.2	34.5
24138CAMK30E4*	204	211	306	269	2.5	0.40	2.5	1.7	1.6	41.5
24138CK30E4	204	211	306	269	2.5	0.40	2.5	1.7	1.6	41.5
22238CAMKE4*	208	—	322	296	3	0.26	3.8	2.6	2.5	35.5
23238CAMKE4*	208	222	322	288	3	0.35	2.8	1.9	1.9	47.6
23238CKE4	208	222	322	288	3	0.35	2.9	1.9	1.9	47.6
22338CAMKE4*	212	—	378	338	4	0.34	2.9	2.0	1.9	77.6

- Remarks**
- The bearings denoted by an asterisk (*) are NSKHP bearings and an oil groove and holes are standard for them.
 - When making a selection of the recommended fit (Tolerance of shaft) on Page A164, in case of NSKHP bearings, the conditions are different.
The segmentations are: Light Loads ($< 0.05C_r$); Normal Loads (0.05 to $0.10C_r$); and Heavy Loads ($> 0.10C_r$).
 - For the dimensions of adapters and withdrawal sleeves, refer to Pages **B381**, and **B386 - B387**.

Spherical Roller Bearings

Bore Diameter 200 – 220 mm

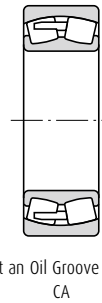
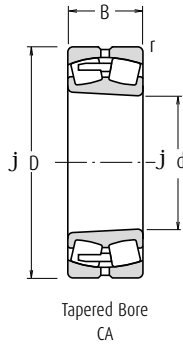
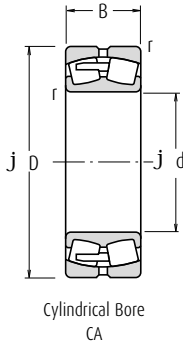

Boundary Dimensions (mm)				Basic Load Ratings (N)		Thermal Reference Speed	Speeds (min ⁻¹)		Bearing
d	D	B	r min.	C _r	C _{0r}		Limiting Speeds		
							Mechanical	Grease	
200	280	60	2.1	570 000	1 060 000	—	—	—	23940CAE4
	280	60	2.1	710 000	1 060 000	2 400	2 600	1 100	23940CAME4 *
	310	82	2.1	1 180 000	1 700 000	1 800	2 400	1 000	23040CAME4 *
	310	109	2.1	1 420 000	2 120 000	1 300	2 000	850	24040CAME4 *
	310	109	2.1	1 140 000	2 120 000	1 300	—	850	24040CE4
	340	112	3	1 700 000	2 330 000	1 500	2 000	800	23140CAME4 *
	340	112	3	1 360 000	2 330 000	1 200	—	800	23140CE4
	340	140	3	1 960 000	2 660 000	950	1 800	800	24140CAME4 *
	340	140	3	1 570 000	2 670 000	900	—	800	24140CE4
	360	98	4	1 620 000	2 010 000	1 700	2 200	950	22240CAME4 *
	360	128	4	2 070 000	2 750 000	1 100	1 800	750	23240CAME4 *
	360	128	4	1 660 000	2 750 000	1 000	—	750	23240CE4
	420	138	5	2 500 000	2 990 000	1 100	1 700	850	22340CAME4 *
	220	300	60	2.1	785 000	1 240 000	2 200	2 600	1 000
340		90	3	1 360 000	1 980 000	1 600	2 200	950	23044CAME4 *
340		118	3	1 640 000	2 490 000	1 200	1 900	750	24044CAME4 *
340		118	3	1 360 000	2 600 000	1 100	—	750	24044CE4
370		120	4	1 960 000	2 710 000	1 300	1 800	710	23144CAME4 *
370		120	4	1 570 000	2 710 000	1 100	—	710	23144CE4
370		150	4	2 250 000	3 200 000	850	1 600	710	24144CAME4 *
370		150	4	1 800 000	3 200 000	850	—	710	24144CE4
400		108	4	1 960 000	2 430 000	1 500	2 000	850	22244CAME4 *
400		144	4	2 520 000	3 400 000	1 000	1 600	670	23244CAME4 *
400		144	4	2 020 000	3 400 000	850	—	670	23244CE4
460	145	5	2 940 000	3 400 000	950	1 600	750	22344CAME4 *	

Note (1) The suffix K or K30 represents bearings with tapered bores (taper 1 : 12 or 1 : 30).

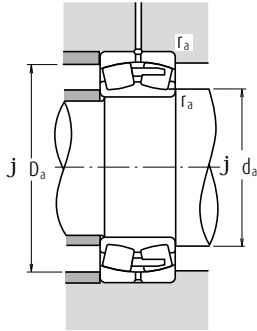

Dynamic Equivalent Load $P = X F_r + Y F_a$

$F_a/F_r \leq e$		$F_a/F_r > e$	
X	Y	X	Y
1	Y_3	0.67	Y_3

Static Equivalent Load

$$P_0 = F_r + Y_0 F_a$$

The values of e , Y_2 , Y_3 and Y_0 are given in the table below.

Numbers	Abutment and Fillet Dimensions (mm)					Constant	Axial Load Factors			Mass (kg)
	d_a		D_a		r_a		e	Y_2	Y_3	
Tapered Bore (!)	min.	max.	max.	min.	max.	approx.				
23940CAKE4	212	—	268	258	2	0.20	5.1	3.4	3.3	11
23940CAMKE4*	212	—	268	258	2	0.20	5.1	3.4	3.3	11
23040CAMKE4*	212	—	268	279	2	0.25	4.0	2.7	2.6	22.6
24040CAMK30E4*	212	223	298	271	2	0.33	3.0	2.0	2.0	30.4
24040CK30E4	212	223	298	271	2	0.32	3.1	2.1	2.0	30.4
23140CAMKE4*	214	232	326	293	2.5	0.30	3.2	2.1	2.1	42.7
23140CKE4	214	232	326	293	2.5	0.31	3.2	2.2	2.1	42.7
24140CAMK30E4*	214	226	326	290	2.5	0.39	2.5	1.7	1.7	51.3
24140CK30E4	214	226	326	290	2.5	0.39	2.6	1.8	1.7	51.3
22240CAMKE4*	218	—	342	315	3	0.26	3.8	2.6	2.5	42.6
23240CAMKE4*	218	237	342	307	3	0.35	2.9	1.9	1.9	57.1
23240CKE4	222	237	342	307	3	0.34	2.9	2.0	1.9	57.1
22340CAMKE4*	232	—	398	352	4	0.34	2.9	2.0	1.9	92.6
23944CAMKE4*	234	—	288	278	2	0.18	5.7	3.8	3.7	12.2
23044CAMKE4*	234	—	326	302	2.5	0.24	4.1	2.8	2.7	29.7
24044CAMK30E4*	234	244	326	296	2.5	0.32	3.2	2.1	2.1	40.5
24044CK30E4	238	244	326	296	2.5	0.31	3.2	2.1	2.1	40.5
23144CAMKE4*	238	254	352	320	3	0.31	3.3	2.2	2.2	53
23144CKE4	238	254	352	320	3	0.30	3.3	2.2	2.2	53
24144CAMK30E4*	238	—	352	313	3	0.39	2.6	1.7	1.7	66.7
24144CK30E4	238	248	352	313	3	0.39	2.6	1.7	1.7	66.7
22244CAMKE4*	238	—	382	348	3	0.27	3.7	2.5	2.4	59
23244CAMKE4*	238	260	382	337	3	0.36	2.8	1.9	1.8	80.4
23244CKE4	238	260	382	337	3	0.35	2.9	1.9	1.9	80.4
22344CAMKE4*	242	—	438	391	4	0.33	3.0	2.0	2.0	116

- Remarks**
- The bearings denoted by an asterisk (*) are NSKHPS bearings and an oil groove and holes are standard for them.
 - When making a selection of the recommended fit (Tolerance of shaft) on Page A164, in case of NSKHPS bearings, the conditions are different.
The segmentations are: Light Loads ($< 0.05C_0$); Normal Loads (0.05 to $0.10C_0$); and Heavy Loads ($> 0.10C_0$).
 - For the dimensions of adapters and withdrawal sleeves, refer to Pages **B381** and **B387**.

Spherical Roller Bearings

Bore Diameter 240 – 280 mm

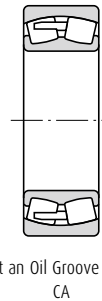
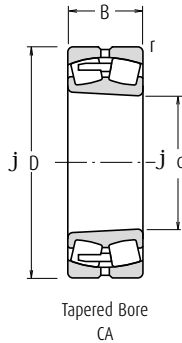
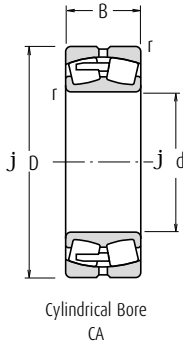

Boundary Dimensions (mm)				Basic Load Ratings (N)		Thermal Reference Speed	Speeds (min ⁻¹)		Bearing	
d	D	B	r min.	C _r	C _{0r}		Limiting Speeds			
							Mechanical	Grease		
240	320	60	2.1	635 000	1 300 000	1 900	2 600	950	23948CAE4	
	320	60	2.1	795 000	1 300 000	1 900	2 600	950	23948CAME4 ⁽¹⁾	
	360	92	3	1 450 000	2 140 000	1 500	2 200	850	23048CAME4 ⁽¹⁾	
	360	118	3	1 730 000	2 730 000	1 100	1 800	710	24048CAME4 ⁽¹⁾	
	360	118	3	1 390 000	2 730 000	1 000	—	710	24048CE4	
	400	128	4	2 230 000	3 100 000	1 200	1 700	670	23148CAME4 ⁽¹⁾	
	400	128	4	1 790 000	3 100 000	1 000	—	670	23148CE4	
	400	160	4	2 660 000	3 800 000	750	1 500	670	24148CAME4 ⁽¹⁾	
	400	160	4	2 130 000	3 800 000	670	—	670	24148CE4	
	440	120	4	2 340 000	2 890 000	1 400	1 800	750	22248CAME4 ⁽¹⁾	
	440	160	4	3 050 000	4 050 000	850	1 500	630	23248CAME4 ⁽¹⁾	
	500	155	5	3 250 000	3 800 000	850	1 500	670	22348CAME4 ⁽¹⁾	
	260	360	75	2.1	1 170 000	1 870 000	1 800	2 200	850	23952CAME4 ⁽¹⁾
		400	104	4	1 780 000	2 580 000	1 300	1 900	800	23052CAME4 ⁽¹⁾
		400	140	4	2 270 000	3 500 000	950	1 600	630	24052CAME4 ⁽¹⁾
440		144	4	2 700 000	3 750 000	1 100	1 500	600	23152CAME4 ⁽¹⁾	
440		180	4	3 200 000	4 700 000	630	1 300	600	24152CAME4 ⁽¹⁾	
480		130	5	2 720 000	3 400 000	1 200	1 700	670	22252CAME4 ⁽¹⁾	
280	480	174	5	3 400 000	4 550 000	800	1 400	560	23252CAME4 ⁽¹⁾	
	540	165	6	3 900 000	4 600 000	750	1 400	630	22352CAME4 ⁽¹⁾	
	380	75	2.1	1 160 000	1 950 000	1 600	2 000	800	23956CAME4 ⁽¹⁾	
	420	106	4	1 930 000	2 950 000	1 200	1 800	710	23056CAME4 ⁽¹⁾	
	420	140	4	2 350 000	3 800 000	850	1 500	600	24056CAME4 ⁽¹⁾	
	460	146	5	2 790 000	4 000 000	1 000	1 500	560	23156CAME4 ⁽¹⁾	
	460	180	5	3 300 000	5 000 000	600	1 300	560	24156CAME4 ⁽¹⁾	
	500	130	5	2 850 000	3 650 000	1 100	1 600	630	22256CAME4 ⁽¹⁾	
	500	176	5	3 600 000	4 900 000	750	1 300	530	23256CAME4 ⁽¹⁾	
	580	175	6	4 350 000	5 150 000	670	1 300	560	22356CAME4 ⁽¹⁾	

Note (1) The suffix K or K30 represents bearings with tapered bores (taper 1 : 12 or 1 : 30).

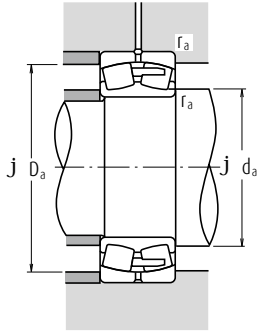

Dynamic Equivalent Load $P = XF_r + YF_a$

$F_a/F_r \leq e$		$F_a/F_r > e$	
X	Y	X	Y
1	Y_3	0.67	Y_3

Static Equivalent Load

$$P_0 = F_r + Y_0 F_a$$

The values of e , Y_2 , Y_3 and Y_0 are given in the table below.

Numbers	Abutment and Fillet Dimensions (mm)					Constant	Axial Load Factors			Mass (kg)
	d_a		D_a		r_a		e	Y_2	Y_3	
Tapered Bore (!)	min.	max.	max.	min.	max.	approx.				
23948CAKE4	252	—	308	298	2	0.17	6.0	4.0	3.9	13.3
23948CAMKE4*	253	—	308	298	2	0.18	6.1	4.1	3.10	13.4
23048CAMKE4*	254	—	346	324	2.5	0.24	4.2	2.8	2.7	32.6
24048CAMK30E4*	254	265	346	317	2.5	0.30	3.4	2.3	2.2	43.4
24048CK30E4	254	265	346	317	2.5	0.29	3.4	2.3	2.2	43.4
23148CAMKE4*	258	275	382	347	3	0.31	3.3	2.2	2.2	66.9
23148CKE4	258	275	382	347	3	0.30	3.3	2.2	2.2	66.9
24148CAMK30E4*	258	268	382	341	3	0.38	2.7	1.8	1.8	79.5
24148CK30E4	258	268	382	341	3	0.38	2.7	1.8	1.8	79.5
22248CAMKE4*	258	—	422	383	3	0.27	3.7	2.5	2.4	80.2
23248CAMKE4*	258	—	422	372	3	0.37	2.7	1.8	1.8	106
22348CAMKE4*	262	—	478	423	4	0.32	3.2	2.1	2.1	147
23952CAMKE4*	272	—	348	333	2	0.19	5.4	3.6	3.5	23
23052CAMKE4*	278	—	382	356	3	0.25	4.1	2.7	2.7	46.6
24052CAMK30E4*	278	—	382	348	3	0.32	3.1	2.1	2.1	62.6
23152CAMKE4*	278	—	422	380	3	0.32	3.2	2.1	2.1	88.2
24152CAMK30E4*	278	—	422	371	3	0.39	2.6	1.7	1.7	109
22252CAMKE4*	282	—	458	418	4	0.27	3.7	2.5	2.5	104
23252CAMKE4*	282	—	458	406	4	0.37	2.7	1.8	1.8	137
22352CAMKE4*	288	—	512	462	5	0.32	3.2	2.1	2.1	180
23956CAMKE4*	292	—	368	351	2	0.18	5.7	3.8	3.8	24.5
23056CAMKE4*	298	—	402	377	3	0.24	4.2	2.8	2.7	50.5
24056CAMK30E4*	298	—	402	369	3	0.31	3.3	2.2	2.2	66.4
23156CAMKE4*	302	—	438	400	4	0.30	3.3	2.2	2.2	94.3
24156CAMK30E4*	302	—	438	392	4	0.37	2.7	1.8	1.8	115
22256CAMKE4*	302	—	478	439	4	0.25	4.0	2.7	2.6	110
23256CAMKE4*	302	—	478	425	4	0.35	2.9	1.9	1.9	147
22356CAMKE4*	308	—	552	496	5	0.31	3.2	2.1	2.1	221

- Remarks**
- The bearings denoted by an asterisk (*) are NSKHPS bearings and an oil groove and holes are standard for them.
 - When making a selection of the recommended fit (Tolerance of shaft) on Page A164, in case of NSKHPS bearings, the conditions are different.
The segmentations are: Light Loads ($< 0.05C_r$); Normal Loads (0.05 to $0.10C_r$); and Heavy Loads ($> 0.10C_r$).
 - For the dimensions of adapters and withdrawal sleeves, refer to Pages **B381**, **B382** and **B387 - B388**.

Spherical Roller Bearings

Bore Diameter 300 – 380 mm

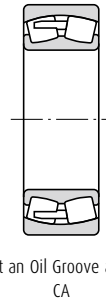
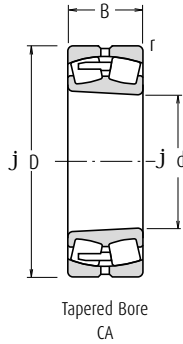
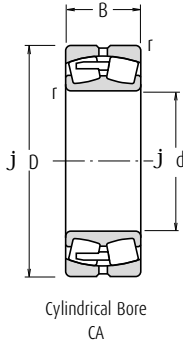

Boundary Dimensions (mm)				Basic Load Ratings (N)		Thermal Reference Speed	Speeds (min ⁻¹)		Bearing
d	D	B	r min.	C _r	C _{0r}		Limiting Speeds		
							Mechanical	Grease	
300	420	90	3	1 540 000	2 490 000	1 500	1 800	710	23960CAME4 ^o
	460	118	4	2 400 000	3 700 000	1 100	1 600	670	23060CAME4 ^o
	460	160	4	2 890 000	4 600 000	800	1 400	530	24060CAME4 ^o
	500	160	5	3 350 000	4 800 000	900	1 400	500	23160CAME4 ^o
	500	200	5	3 900 000	5 800 000	530	1 200	500	24160CAME4 ^o
	540	140	5	3 250 000	4 250 000	1 000	1 500	600	22260CAME4 ^o
	540	192	5	4 250 000	5 900 000	670	1 200	480	23260CAME4 ^o
320	440	90	3	1 620 000	2 750 000	1 400	1 700	670	23964CAME4 ^o
	480	121	4	2 450 000	3 850 000	1 000	1 600	630	23064CAME4 ^o
	480	160	4	3 050 000	5 050 000	710	1 300	500	24064CAME4 ^o
	540	176	5	3 850 000	5 500 000	800	1 300	480	23164CAME4 ^o
	540	218	5	4 400 000	6 650 000	480	1 100	480	24164CAME4 ^o
	580	150	5	3 750 000	4 850 000	950	1 400	530	22264CAME4 ^o
	580	208	5	4 850 000	6 900 000	600	1 100	450	23264CAME4 ^o
340	460	90	3	1 670 000	2 840 000	1 300	1 700	630	23968CAME4 ^o
	520	133	5	2 850 000	4 400 000	950	1 500	560	23068CAME4 ^o
	520	180	5	3 650 000	6 050 000	670	1 200	480	24068CAME4 ^o
	580	190	5	4 500 000	6 600 000	710	1 200	430	23168CAME4 ^o
	580	243	5	5 300 000	7 900 000	450	1 000	430	24168CAME4 ^o
	620	224	6	4 400 000	7 800 000	480	—	400	23268CAME4
360	480	90	3	1 730 000	3 050 000	1 200	1 700	600	23972CAME4 ^o
	540	134	5	2 990 000	4 700 000	900	1 400	530	23072CAME4 ^o
	540	180	5	3 650 000	6 100 000	630	1 200	450	24072CAME4 ^o
	600	192	5	4 800 000	7 100 000	670	1 100	400	23172CAME4 ^o
	600	243	5	5 250 000	8 000 000	430	1 000	400	24172CAME4 ^o
	600	232	6	4 800 000	8 550 000	450	—	380	23272CAME4
380	520	106	4	2 340 000	4 100 000	1 100	1 500	530	23976CAME4 ^o
	560	135	5	3 150 000	5 100 000	850	1 400	530	23076CAME4 ^o
	560	180	5	3 850 000	6 600 000	600	1 200	430	24076CAME4 ^o
	620	194	5	4 000 000	7 600 000	530	—	400	23176CAME4
	620	243	5	4 350 000	8 450 000	360	—	400	24176CAME4
	680	240	6	5 150 000	9 200 000	430	—	360	23276CAME4

Note (1) The suffix K or K30 represents bearings with tapered bores (taper 1 : 12 or 1 : 30).

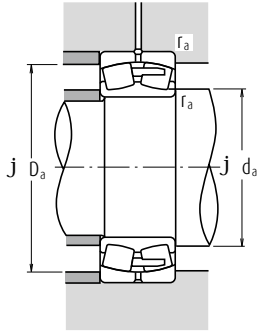

Dynamic Equivalent Load $P = XF_r + YF_a$

$F_a/F_r \leq e$		$F_a/F_r > e$	
X	Y	X	Y
1	Y_3	0.67	Y_3

Static Equivalent Load

$$P_0 = F_r + Y_0 F_a$$

The values of e , Y_2 , Y_3 and Y_0 are given in the table below.

Numbers	Abutment and Fillet Dimensions (mm)					Constant	Axial Load Factors			Mass (kg)
	d_a		D_a		r_a		e	Y_2	Y_3	
Tapered Bore (!)	min.	max.	min.	max.	max.	approx.				
23960CAMKE4*	314	—	406	386	2.5	0.19	5.2	3.5	3.4	38.2
23060CAMKE4*	318	—	442	413	3	0.24	4.2	2.8	2.7	70.5
24060CAMK30E4*	318	—	442	400	3	0.32	3.1	2.1	2.0	93.6
23160CAMKE4*	322	—	478	433	4	0.31	3.3	2.2	2.2	125
24160CAMK30E4*	322	—	478	423	4	0.38	2.6	1.8	1.7	152
22260CAMKE4*	322	—	518	473	4	0.25	4.0	2.7	2.6	139
23260CAMKE4*	322	—	518	458	4	0.35	2.9	1.9	1.9	189
23964CAMKE4*	334	—	426	406	2.5	0.18	5.5	3.7	3.6	40.6
23064CAMKE4*	338	—	462	432	3	0.24	4.2	2.8	2.8	75.6
24064CAMK30E4*	338	—	462	422	3	0.31	3.3	2.2	2.2	99.7
23164CAMKE4*	342	—	518	466	4	0.31	3.2	2.1	2.1	162
24164CAMK30E4*	342	—	518	456	4	0.39	2.6	1.7	1.7	196
22264CAMKE4*	342	—	558	508	4	0.26	3.9	2.6	2.6	174
23264CAMKE4*	342	—	558	488	4	0.36	2.8	1.9	1.8	239
23968CAMKE4*	354	—	446	427	2.5	0.18	5.7	3.8	3.7	42.4
23068CAMKE4*	362	—	498	465	4	0.24	4.2	2.8	2.8	101
24068CAMK30E4*	362	—	498	454	4	0.32	3.2	2.1	2.1	135
23168CAMKE4*	362	—	558	499	4	0.31	3.2	2.1	2.1	206
24168CAMK30E4*	362	—	558	489	4	0.40	2.5	1.7	1.7	257
23268CAMKE4*	368	—	592	521	5	0.36	2.8	1.9	1.8	295
23972CAMKE4*	374	—	466	447	2.5	0.17	6.0	4.1	4.0	44.7
23072CAMKE4*	382	—	518	485	4	0.24	4.2	2.8	2.8	106
24072CAMK30E4*	382	—	518	476	4	0.32	3.2	2.1	2.1	139
23172CAMKE4*	382	—	578	520	4	0.31	3.2	2.2	2.1	217
24172CAMK30E4*	382	—	578	507	4	0.40	2.5	1.7	1.7	264
23272CAMKE4*	388	—	622	549	5	0.36	2.8	1.9	1.8	342
23976CAMKE4*	398	—	502	482	3	0.18	5.5	3.7	3.6	65.4
23076CAMKE4*	402	—	538	506	4	0.22	4.5	3.0	3.0	113
24076CAMK30E4*	402	—	538	496	4	0.29	3.4	2.3	2.3	148
23176CAMKE4	402	—	598	540	4	0.30	3.3	2.2	2.2	229
24176CAMK30E4	402	—	598	529	4	0.38	2.6	1.8	1.7	275
23276CAMKE4	408	—	652	578	5	0.35	2.9	1.9	1.9	372

- Remarks**
- The bearings denoted by an asterisk (*) are NSKHPS bearings and an oil groove and holes are standard for them.
 - When making a selection of the recommended fit (Tolerance of shaft) on Page A164, in case of NSKHPS bearings, the conditions are different.
The segmentations are: Light Loads ($< 0.05C_0$); Normal Loads (0.05 to $0.10C_0$); and Heavy Loads ($> 0.10C_0$).
 - For the dimensions of adapters and withdrawal sleeves, refer to Pages **B382** and **B388**.

Spherical Roller Bearings

Bore Diameter 400 – 460 mm

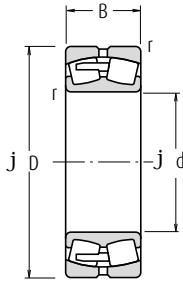

Cylindrical Bore
CA

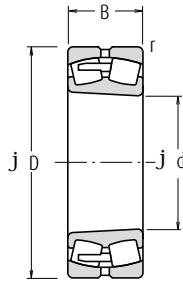

Tapered Bore
CA

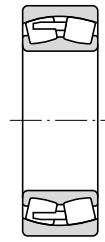

Without an Oil Groove and Holes
CA

Boundary Dimensions (mm)				Basic Load Ratings (N)		Thermal Reference Speed	Speeds (min ⁻¹)		Bearing
d	D	B	r min.	C _r	C _{0r}		Limiting Speeds		
							Mechanical	Grease	
400	540	106	4	2 370 000	4 250 000	1 000	1 400	530	23980CAME4 [†]
600	148	5	5	3 700 000	5 900 000	800	1 300	480	23080CAME4 [†]
600	200	5	5	4 500 000	7 600 000	550	1 100	400	24080CAME4 [†]
650	200	6	6	4 150 000	7 900 000	500	—	380	23180CAME4
650	250	6	6	4 950 000	10 100 000	320	—	380	24180CAME4
720	256	6	6	5 800 000	10 400 000	380	—	340	23280CAME4
420	560	106	4	2 340 000	4 250 000	1 000	1 400	500	23984CAME4 [†]
620	150	5	5	2 910 000	5 850 000	670	—	450	23084CAME4
620	200	5	5	3 750 000	8 100 000	480	—	380	24084CAME4
700	224	6	6	5 000 000	9 400 000	480	—	340	23184CAME4
700	280	6	6	6 000 000	12 000 000	280	—	340	24184CAME4
760	272	7.5	7.5	6 450 000	11 700 000	360	—	320	23284CAME4
440	600	118	4	2 190 000	4 800 000	630	—	450	23988CAME4
650	157	6	6	3 150 000	6 350 000	630	—	430	23088CAME4
650	212	6	6	4 150 000	9 100 000	450	—	360	24088CAME4
720	226	6	6	5 300 000	10 300 000	430	—	320	23188CAME4
720	280	6	6	6 000 000	12 100 000	280	—	320	24188CAME4
790	280	7.5	7.5	6 900 000	12 800 000	340	—	300	23288CAME4
460	620	118	4	2 220 000	4 950 000	600	—	430	23992CAME4
680	163	6	6	3 450 000	7 100 000	600	—	400	23092CAME4
680	218	6	6	4 500 000	9 950 000	430	—	340	24092CAME4
760	240	7.5	7.5	5 700 000	10 900 000	430	—	300	23192CAME4
760	300	7.5	7.5	6 300 000	12 400 000	280	—	300	24192CAME4
830	296	7.5	7.5	7 350 000	13 700 000	320	—	280	23292CAME4

Note (†) The suffix K or K30 represents bearings with tapered bores (taper 1 : 12 or 1 : 30).

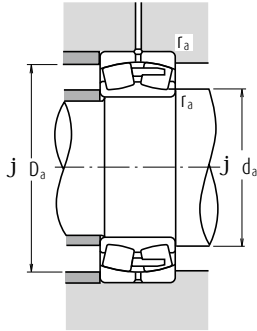

Dynamic Equivalent Load $P = X F_r + Y F_a$

$F_a/F_r \leq e$		$F_a/F_r > e$	
X	Y	X	Y
1	Y_3	0.67	Y_3

Static Equivalent Load

$$P_0 = F_r + Y_0 F_a$$

The values of e , Y_2 , Y_3 and Y_0 are given in the table below.

Numbers	Abutment and Fillet Dimensions (mm)					Constant	Axial Load Factors			Mass (kg)
	d_a		D_a		r_a		e	Y_2	Y_3	
Tapered Bore (!)	min.	max.	max.	min.	max.	approx.				
23980CAMKE4*	418	—	522	501	3	0.18	5.7	3.9	3.8	69.1
23080CAMKE4*	422	—	578	540	4	0.23	4.4	3.0	2.9	146
24080CAMK30E4*	422	—	578	527	4	0.31	3.3	2.2	2.2	193
23180CAMKE4	428	—	622	569	5	0.29	3.4	2.3	2.3	257
24180CAMK30E4	428	—	622	551	5	0.37	2.7	1.8	1.8	316
23280CAMKE4	428	—	692	610	5	0.36	2.8	1.9	1.9	449
23984CAMKE4*	438	—	542	521	3	0.17	6.0	4.0	3.9	71.6
23084CAMKE4	442	—	598	562	4	0.23	4.3	2.9	2.8	151
24084CAMK30E4	442	—	598	549	4	0.31	3.2	2.2	2.1	199
23184CAMKE4	448	—	672	607	5	0.31	3.3	2.2	2.2	341
24184CAMK30E4	448	—	672	598	5	0.38	2.6	1.8	1.7	421
23284CAMKE4	456	—	724	644	6	0.35	2.9	1.9	1.9	534
23988CAMKE4	458	—	582	555	3	0.18	5.7	3.9	3.8	96.3
23088CAMKE4	468	—	622	587	5	0.23	4.3	2.9	2.8	173
24088CAMK30E4	468	—	622	576	5	0.31	3.2	2.1	2.1	237
23188CAMKE4	468	—	692	627	5	0.3	3.3	2.2	2.2	360
24188CAMK30E4	468	—	692	617	5	0.37	2.7	1.8	1.8	433
23288CAMKE4	476	—	754	669	6	0.35	2.9	1.9	1.9	594
23992CAMKE4	478	—	602	575	3	0.17	5.9	4.0	3.9	100
23092CAMKE4	488	—	652	615	5	0.22	4.6	3.1	3.0	201
24092CAMK30E4	488	—	652	604	5	0.29	3.4	2.3	2.3	266
23192CAMKE4	496	—	724	661	6	0.31	3.3	2.2	2.2	423
24192CAMK30E4	496	—	724	646	6	0.39	2.6	1.7	1.7	512
23292CAMKE4	496	—	794	702	6	0.37	2.8	1.9	1.8	691

- Remarks**
- The bearings denoted by an asterisk (*) are NSKHPS bearings and an oil groove and holes are standard for them.
 - When making a selection of the recommended fit (Tolerance of shaft) on Page A164, in case of NSKHPS bearings, the conditions are different.
The segmentations are: Light Loads ($< 0.05C_0$); Normal Loads (0.05 to 0.10 C_0); and Heavy Loads ($> 0.10C_0$).
 - For the dimensions of adapters and withdrawal sleeves, refer to Pages **B382 - B383 and B389**.



Spherical Roller Bearings

Bore Diameter 480 – 560 mm

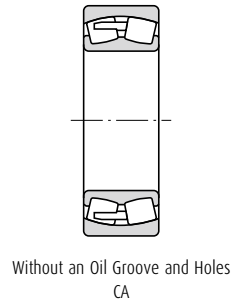
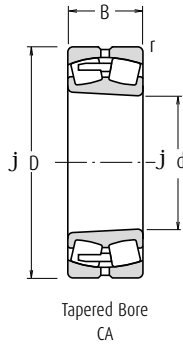
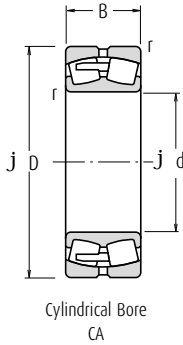

Boundary Dimensions (mm)				Basic Load Ratings (N)		Thermal Reference Speed	Speeds (min ⁻¹)		Bearing
d	D	B	r min.	C _r	C _{0r}		Limiting Speeds		
							Mechanical	Grease	
480	650	128	5	2 580 000	5 850 000	560	—	400	23996CAME4
	700	165	6	3 800 000	7 950 000	560	—	400	23096CAME4
	700	218	6	4 600 000	10 200 000	400	—	320	24096CAME4
	790	248	7.5	6 050 000	11 700 000	400	—	300	23196CAME4
	790	308	7.5	7 150 000	14 600 000	240	—	300	24196CAME4
	870	310	7.5	7 850 000	14 400 000	300	—	260	23296CAME4
500	670	128	5	2 460 000	5 550 000	560	—	400	239/500CAME4
	720	167	6	3 750 000	8 100 000	530	—	380	230/500CAME4
	720	218	6	4 450 000	9 900 000	400	—	300	240/500CAME4
	830	264	7.5	6 850 000	13 400 000	360	—	280	231/500CAME4
	830	325	7.5	8 000 000	16 000 000	220	—	280	241/500CAME4
	920	336	7.5	9 000 000	16 600 000	280	—	260	232/500CAME4
530	710	136	5	2 930 000	6 800 000	500	—	360	239/530CAME4
	780	185	6	4 440 000	9 200 000	500	—	340	230/530CAME4
	780	250	6	5 400 000	11 800 000	360	—	280	240/530CAME4
	870	272	7.5	7 150 000	14 100 000	340	—	260	231/530CAME4
	870	335	7.5	8 500 000	17 500 000	200	—	260	241/530CAME4
	980	355	9.5	10 100 000	18 800 000	260	—	240	232/530CAME4
560	750	140	5	3 100 000	7 250 000	480	—	340	239/560CAME4
	820	195	6	5 000 000	10 700 000	450	—	320	230/560CAME4
	820	258	6	5 950 000	13 300 000	340	—	260	240/560CAME4
	920	280	7.5	7 850 000	15 500 000	320	—	240	231/560CAME4
	920	355	7.5	9 400 000	19 600 000	190	—	240	241/560CAME4
	1 030	365	9.5	10 900 000	20 500 000	240	—	220	232/560CAME4

Note (1) The suffix K or K30 represents bearings with tapered bores (taper 1 : 12 or 1 : 30).

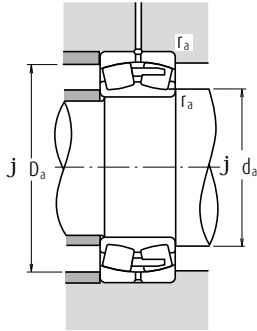

Dynamic Equivalent Load $P = X F_r + Y F_a$

$F_a/F_r \leq e$		$F_a/F_r > e$	
X	Y	X	Y
1	Y_3	0.67	Y_3

Static Equivalent Load

$$P_0 = F_r + Y_0 F_a$$

The values of e , Y_2 , Y_3 and Y_0 are given in the table below.

Numbers	Abutment and Fillet Dimensions (mm)					Constant	Axial Load Factors			Mass (kg)
	d_a		D_a		r_a		e	Y_2	Y_3	
Tapered Bore (1)	min.	max.	min.	max.	max.					
23996CAMKE4	502	—	628	602	4	0.18	5.7	3.8	3.7	121
23096CAMKE4	508	—	672	633	5	0.22	4.6	3.1	3.0	211
24096CAMK30E4	508	—	672	625	5	0.30	3.4	2.3	2.2	270
23196CAMKE4	516	—	754	688	6	0.31	3.3	2.2	2.2	475
24196CAMK30E4	516	—	754	670	6	0.37	2.6	1.7	1.7	567
23296CAMKE4	516	—	834	733	6	0.36	2.8	1.9	1.8	795
239/500CAMKE4	522	—	648	622	4	0.17	6.0	4.0	3.9	124
230/500CAMKE4	528	—	692	655	5	0.21	4.8	3.2	3.1	220
240/500CAMK30E4	528	—	692	643	5	0.30	3.4	2.3	2.2	276
231/500CAMKE4	536	—	794	720	6	0.31	3.2	2.2	2.1	567
241/500CAMK30E4	536	—	794	703	6	0.39	2.6	1.7	1.7	666
232/500CAMKE4	536	—	884	773	6	0.38	2.7	1.8	1.8	969
239/530CAMKE4	552	—	688	659	4	0.17	6.0	4.0	3.9	149
230/530CAMKE4	558	—	752	706	5	0.22	4.6	3.1	3.0	298
240/530CAMK30E4	558	—	752	690	5	0.31	3.3	2.2	2.2	390
231/530CAMKE4	566	—	834	758	6	0.30	3.3	2.2	2.2	628
241/530CAMK30E4	566	—	834	740	6	0.38	2.6	1.8	1.7	773
232/530CAMKE4	574	—	936	824	8	0.38	2.7	1.8	1.7	1 170
239/560CAMKE4	582	—	728	697	4	0.16	6.1	4.1	4.0	172
230/560CAMKE4	588	—	792	742	5	0.22	4.5	3.0	2.9	344
240/560CAMK30E4	588	—	792	729	5	0.30	3.3	2.2	2.2	440
231/560CAMKE4	596	—	884	804	6	0.30	3.4	2.3	2.2	727
241/560CAMK30E4	596	—	884	782	6	0.39	2.6	1.8	1.7	886
232/560CAMKE4	604	—	986	870	8	0.36	2.8	1.9	1.8	1 320

Remark For the dimensions of adapters ($d=470$ mm) and withdrawal sleeves, refer to Pages B383 and B389.



Spherical Roller Bearings

Bore Diameter 600 – 750 mm

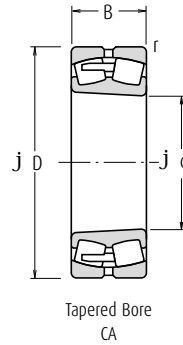
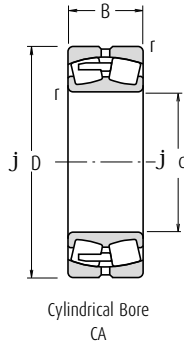

Boundary Dimensions (mm)				Basic Load Ratings (N)		Thermal Reference Speed	Speeds (min ⁻¹)		Bearing
d	D	B	r min.	C _r	C _{0r}		Limiting Speeds		
							Mechanical	Grease	
600	800	150	5	3 450 000	8 100 000	450	—	320	239/600CAME4
	870	200	6	5 450 000	12 200 000	400	—	300	230/600CAME4
	870	272	6	6 600 000	15 100 000	300	—	240	240/600CAME4
	980	300	7.5	8 750 000	17 500 000	280	—	220	231/600CAME4
	980	375	7.5	10 400 000	21 900 000	170	—	220	241/600CAME4
630	1 090	388	9.5	12 700 000	24 900 000	200	—	200	232/600CAME4
	850	165	6	4 000 000	9 350 000	400	—	300	239/630CAME4
	920	212	7.5	5 900 000	12 700 000	400	—	280	230/630CAME4
	920	290	7.5	7 550 000	17 700 000	280	—	220	240/630CAME4
	1 030	315	7.5	9 600 000	19 400 000	260	—	200	231/630CAME4
670	1 030	400	7.5	11 300 000	23 900 000	160	—	200	241/630CAME4
	1 150	412	12	13 400 000	25 600 000	200	—	180	232/630CAME4
	900	170	6	4 350 000	10 300 000	380	—	260	239/670CAME4
	980	230	7.5	6 850 000	15 000 000	360	—	240	230/670CAME4
	980	308	7.5	8 450 000	19 500 000	260	—	200	240/670CAME4
710	1 090	336	7.5	10 600 000	21 600 000	240	—	190	231/670CAME4
	1 090	412	7.5	12 400 000	26 500 000	150	—	190	241/670CAME4
	1 220	438	12	14 900 000	28 700 000	180	—	170	232/670CAME4
	950	180	6	4 800 000	11 700 000	360	—	240	239/710CAME4
	1 030	236	7.5	7 100 000	15 800 000	340	—	240	230/710CAME4
750	1 030	315	7.5	8 850 000	20 700 000	240	—	190	240/710CAME4
	1 150	438	9.5	13 900 000	30 500 000	130	—	170	241/710CAME4
	1 280	450	12	15 700 000	30 500 000	170	—	160	232/710CAME4
	1 000	185	6	5 250 000	12 800 000	320	—	220	239/750CAME4
	1 090	250	7.5	7 750 000	17 200 000	320	—	220	230/750CAME4
750	1 090	335	7.5	10 100 000	24 000 000	220	—	180	240/750CAME4
	1 360	475	15	17 700 000	35 500 000	150	—	140	232/750CAME4

Note (!) The suffix K or K30 represents bearings with tapered bores (taper 1 : 12 or 1 : 30).

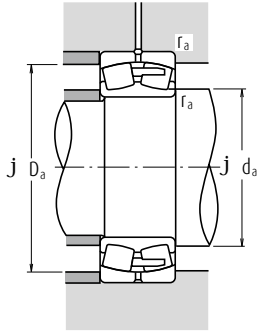

Dynamic Equivalent Load $P = XF_r + YF_a$

$F_a/F_r \leq e$		$F_a/F_r > e$	
X	Y	X	Y
1	Y_3	0.67	Y_3

Static Equivalent Load

$$P_0 = F_r + Y_0 F_a$$

The values of e , Y_2 , Y_3 and Y_0 are given in the table below.

Numbers	Abutment and Fillet Dimensions (mm)					Constant	Axial Load Factors			Mass (kg)
	d_a		D_a		r_a		e	Y_2	Y_3	
Tapered Bore (!)	min.	max.	max.	min.	max.	approx.				
239/600CAMKE4	622	—	778	745	4	0.17	5.9	3.9	3.9	205
230/600CAMKE4	628	—	842	794	5	0.21	4.8	3.3	3.2	389
240/600CAMK30E4	628	—	842	772	5	0.30	3.3	2.2	2.2	529
231/600CAMKE4	636	—	944	856	6	0.30	3.4	2.3	2.2	898
241/600CAMK30E4	636	—	944	836	6	0.39	2.6	1.8	1.7	1 050
232/600CAMKE4	644	—	1 046	923	8	0.36	2.8	1.9	1.8	1 590
239/630CAMKE4	658	—	822	786	5	0.18	5.6	3.8	3.7	259
230/630CAMKE4	666	—	884	835	6	0.22	4.7	3.1	3.1	468
240/630CAMK30E4	666	—	884	815	6	0.30	3.3	2.2	2.2	637
231/630CAMKE4	666	—	994	900	6	0.30	3.4	2.3	2.2	1 040
241/630CAMK30E4	666	—	994	876	6	0.38	2.7	1.8	1.7	1 250
232/630CAMKE4	684	—	1 096	970	10	0.37	2.8	1.9	1.8	1 850
239/670CAMKE4	698	—	872	836	5	0.17	5.8	3.9	3.8	300
230/670CAMKE4	706	—	944	891	6	0.22	4.7	3.1	3.1	571
240/670CAMK30E4	706	—	944	868	6	0.30	3.3	2.2	2.2	773
231/670CAMKE4	706	—	1 054	952	6	0.30	3.3	2.2	2.2	1 230
241/670CAMK30E4	706	—	1 054	934	6	0.37	2.7	1.8	1.8	1 440
232/670CAMKE4	724	—	1 166	1 024	10	0.37	2.7	1.8	1.8	2 210
239/710CAMKE4	738	—	922	883	5	0.17	5.8	3.9	3.8	352
230/710CAMKE4	746	—	994	936	6	0.22	4.6	3.1	3.0	647
240/710CAMK30E4	746	—	994	916	6	0.29	3.4	2.3	2.2	861
241/710CAMK30E4	754	—	1 106	981	8	0.38	2.6	1.8	1.7	1 730
232/710CAMKE4	764	—	1 226	1 080	10	0.36	2.8	1.9	1.8	2 470
239/750CAMKE4	778	—	972	931	5	0.17	6.0	4.1	4.0	398
230/750CAMKE4	786	—	1 054	990	6	0.22	4.6	3.1	3.0	768
240/750CAMK30E4	786	—	1 054	969	6	0.29	3.4	2.3	2.2	1 030
232/750CAMKE4	814	—	1 296	1 148	12	0.36	2.8	1.9	1.8	2 980



Spherical Roller Bearings

Bore Diameter 800 – 1400 mm

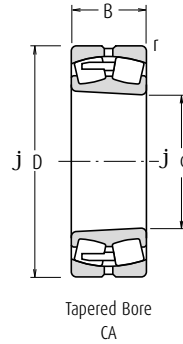
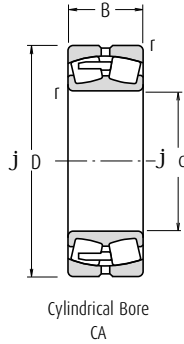

Boundary Dimensions (mm)				Basic Load Ratings (N)		Thermal Reference Speed	Speeds (min ⁻¹)		Bearing
d	D	B	r min.	C _r	C _{0r}		Limiting Speeds		
							Mechanical	Grease	
800	1 060	195	6	5 600 000	13 700 000	300	—	220	239/800CAME4
	1 150	258	7.5	8 350 000	19 100 000	300	—	200	230/800CAME4
	1 150	345	7.5	10 900 000	26 300 000	200	—	160	240/800CAME4
	1 280	375	9.5	13 800 000	29 200 000	190	—	150	231/800CAME4
850	1 420	488	15	20 300 000	41 000 000	130	—	130	232/800CAME4
	1 120	200	6	6 100 000	15 200 000	280	—	190	239/850CAME4
	1 220	272	7.5	9 300 000	21 400 000	280	—	180	230/850CAME4
	1 220	365	7.5	11 600 000	28 300 000	190	—	150	240/850CAME4
900	1 500	515	15	22 300 000	45 500 000	120	—	120	232/850CAME4
	1 180	206	6	6 660 000	16 700 000	260	—	180	239/900CAME4
	1 280	280	7.5	9 850 000	22 800 000	260	—	160	230/900CAME4
950	1 280	375	7.5	12 800 000	31 500 000	170	—	140	240/900CAME4
	1 580	515	15	23 400 000	47 500 000	120	—	110	232/900CAME4
	1 250	224	7.5	7 600 000	19 900 000	240	—	160	239/950CAME4
	1 360	300	7.5	11 300 000	26 500 000	240	—	150	230/950CAME4
1 000	1 360	412	7.5	14 500 000	36 500 000	160	—	120	240/950CAME4
	1 660	530	15	24 700 000	50 500 000	110	—	100	232/950CAME4
	1 320	236	7.5	8 200 000	21 700 000	220	—	150	239/1000CAME4
	1 420	308	7.5	11 900 000	28 100 000	220	—	140	230/1000CAME4
1 060	1 420	412	7.5	15 300 000	38 500 000	150	—	110	240/1000CAME4
	1 400	250	7.5	9 300 000	24 400 000	200	—	130	239/1060CAME4
	1 500	325	9.5	13 000 000	31 500 000	200	—	120	230/1060CAME4
1 120	1 500	438	9.5	16 800 000	43 000 000	140	—	100	240/1060CAME4
	1 580	345	9.5	15 400 000	38 000 000	180	—	110	230/1120CAME4
	1 580	462	9.5	18 700 000	49 500 000	120	—	95	240/1120CAME4
1 180	1 660	475	9.5	20 200 000	52 500 000	120	—	85	240/1180CAME4
1 250	1 750	500	9.5	21 000 000	59 500 000	110	—	75	240/1250CAME4
1 320	1 850	530	12	22 600 000	63 500 000	100	—	67	240/1320CAME4
1 400	1 950	545	12	24 500 000	65 000 000	95	—	60	240/1400CAME4

Note (1) The suffix K or K30 represents bearings with tapered bores (taper 1 : 12 or 1 : 30).

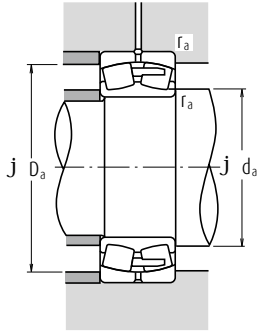

Dynamic Equivalent Load $P = X F_r + Y F_a$

$F_a/F_r \leq e$		$F_a/F_r > e$	
X	Y	X	Y
1	Y_3	0.67	Y_3

Static Equivalent Load

$$P_0 = F_r + Y_0 F_a$$

The values of e , Y_2 , Y_3 and Y_0 are given in the table below.

Numbers	Abutment and Fillet Dimensions (mm)					Constant	Axial Load Factors			Mass (kg)
	d_a		D_a		r_a		e	Y_2	Y_3	
Tapered Bore (!)	min.	max.	min.	max.	max.					
239/800CAMKE4	828	—	1 032	987	5	0.17	6.0	4.0	3.9	462
230/800CAMKE4	836	—	1 114	1 045	6	0.21	4.7	3.2	3.1	870
240/800CAMK30E4	836	—	1 114	1 029	6	0.27	3.7	2.5	2.5	1 130
231/800CAMKE4	844	—	1 236	1 127	8	0.28	3.6	2.4	2.3	1 870
232/800CAMKE4	864	—	1 356	1 208	12	0.35	2.8	1.9	1.9	3 250
239/850CAMKE4	878	—	1 092	1 046	5	0.16	6.2	4.2	4.1	523
230/850CAMKE4	886	—	1 184	1 109	6	0.21	4.8	3.2	3.1	1 020
240/850CAMK30E4	886	—	1 184	1 093	6	0.28	3.6	2.4	2.4	1 350
232/850CAMKE4	914	—	1 436	1 274	12	0.35	2.8	1.9	1.9	3 890
239/900CAMKE4	928	—	1 152	1 103	5	0.16	6.4	4.3	4.2	591
230/900CAMKE4	936	—	1 244	1 169	6	0.20	4.9	3.3	3.2	1 160
240/900CAMK30E4	936	—	1 244	1 147	6	0.28	3.6	2.4	2.4	1 520
232/900CAMKE4	964	—	1 516	1 354	12	0.33	3.0	2.0	2.0	4 300
239/950CAMKE4	986	—	1 214	1 169	6	0.16	6.3	4.2	4.1	732
230/950CAMKE4	986	—	1 324	1 241	6	0.21	4.8	3.2	3.2	1 400
240/950CAMK30E4	986	—	1 324	1 219	6	0.28	3.6	2.4	2.3	1 880
232/950CAMKE4	1 014	—	1 596	1 428	12	0.32	3.1	2.1	2.1	4 800
239/1000CAMKE4	1 036	—	1 284	1 229	6	0.16	6.4	4.3	4.2	881
230/1000CAMKE4	1 036	—	1 384	1 298	6	0.20	4.9	3.3	3.2	1 560
240/1000CAMK30E4	1 036	—	1 384	1 275	6	0.27	3.7	2.5	2.4	2 010
239/1060CAMKE4	1 096	—	1 384	1 302	6	0.16	6.1	4.1	4.0	1 030
230/1060CAMKE4	1 104	—	1 456	1 368	8	0.21	4.9	3.3	3.2	1 790
240/1060CAMK30E4	1 104	—	1 456	1 346	8	0.28	3.6	2.4	2.4	2 410
230/1120CAMKE4	1 164	—	1 536	1 444	8	0.20	5.0	3.4	3.3	2 120
240/1120CAMK30E4	1 164	—	1 536	1 421	8	0.27	3.7	2.5	2.5	2 790
240/1180CAMK30E4	1 224	—	1 616	1 494	8	0.27	3.7	2.5	2.4	3 180
240/1250CAMK30E4	1 294	—	1 706	1 579	8	0.25	4.0	2.7	2.6	3 700
240/1320CAMK30E4	1 374	—	1 796	1 656	10	0.26	3.9	2.6	2.6	4 400
240/1400CAMK30E4	1 454	—	1 896	1 767	10	0.25	4.0	2.7	2.6	4 900



Thrust Ball Bearings



8. THRUST BALL BEARINGS

Introduction.....	Page
	B 314

BEARINGS TABLE

SINGLE-DIRECTION THRUST BALL BEARINGS

With Flat Seat, Aligning Seat, or Aligning Seat Washer	Bore Dia.	Page
	10 - 360 mm.....	B 316

DOUBLE-DIRECTION THRUST BALL BEARINGS

With Flat Seat, Aligning Seat, or Aligning Seat Washer	Bore Dia.	Page
	10 - 190 mm.....	B 324



Thrust Ball Bearings

DESIGN, TYPES, AND FEATURES

THRUST BALL BEARINGS

Thrust ball bearings are classified into those with flat seats or aligning seats depending on the shape of the outer ring seat (housing washer). They can sustain axial loads but no radial loads.

The series of thrust ball bearings available are shown in Table 1.

For Single-Direction Thrust Ball Bearings, pressed steel cages and machined brass cages are usually used as shown in Table 2. The cages in Double-Direction Thrust Ball Bearings are the same as those in Single-Direction Thrust Ball Bearings of the same diameter series.

The basic load ratings listed in the bearing tables are based on the standard cage type shown in Table 2.

If the type of cage is different for bearings with the same number, the number of balls may vary, in such a case, the load rating will differ from the one listed in the bearing tables.

Table 1 Series of Thrust Ball Bearings

	W/Flat Seat	W/Aligning Seat	W/Aligning Seat Washer
Single-Direction	511	—	—
	512	532	532U
	513	533	533U
	514	534	534U
Double-Direction	522	542	542U
	523	543	543U
	524	544	544U

Table 2 Standard Cages for Thrust Ball Bearings

Pressed Steel	Machined Brass
51100 - 51152X	51156X - 51172X
51200 - 51236X	51238X - 51272X
51305 - 51336X	51338X - 51340X
51405 - 51418X	51420X - 51436X
53200 - 53236X	53238X - 53272X
53305 - 53336X	53338X - 53340X
53405 - 53418X	53420X - 53436X

TOLERANCES AND RUNNING ACCURACY

Thrust Ball Bearings

Table	Pages
7.6.....	A140 to A142

RECOMMENDED FITS

Thrust Ball Bearings

Table	Page
8.4.....	A164
8.6.....	A165

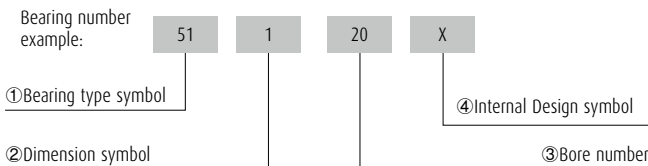

①Bearing type symbol: 51: single direction
52: double direction

②Dimension symbol: 1: 1 series
2: 2 series
3: 3 series
4: 4 series

③Bore number: Less than 03, Bearing bore 00 : 10 mm, 01 : 12 mm,
02 : 15 mm, 03 : 17 mm

Over 04, Bearing bore Bore number ×5 (mm)

④Internal Design symbol: see note (1) in bearing tables



MINIMUM AXIAL LOAD

It is necessary to apply some axial load to thrust bearings to prevent slippage between the rolling elements and raceways.
For more details, please refer to Page A198



Single-Direction Thrust Ball Bearings

Bore Diameter 10 – 50 mm

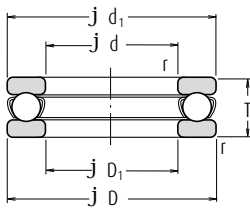

With Flat Seat

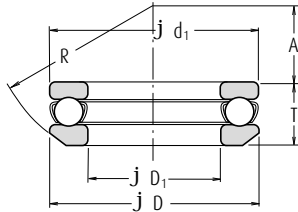

With Aligning Seat

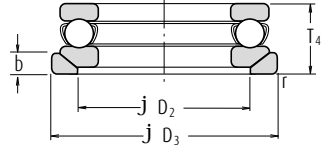

With Aligning Seat Washer

d	Boundary Dimensions (mm)					r min.	Basic Load Ratings (N)		Limiting Speeds (min ⁻¹)		With Flat Seat
	D	T	T ₃	T ₄	C _a		C _{0a}	Grease	Oil		
10	24	9	—	—	0.3	10 100	14 000	6 700	10 000	51100	
	26	11	11.6	13	0.6	12 800	17 100	6 000	9 000	51200	
12	26	9	—	—	0.3	10 400	15 400	6 700	10 000	51101	
	28	11	11.4	13	0.6	13 300	19 000	5 600	8 500	51201	
15	28	9	—	—	0.3	10 600	16 800	6 300	9 500	51102	
	32	12	13.3	15	0.6	16 700	24 800	5 000	7 500	51202	
17	30	9	—	—	0.3	11 400	19 500	6 000	9 000	51103	
	35	12	13.2	15	0.6	17 300	27 300	4 800	7 500	51203	
20	35	10	—	—	0.3	15 100	26 600	5 300	8 000	51104	
	40	14	14.7	17	0.6	22 500	37 500	4 300	6 300	51204	
25	42	11	—	—	0.6	19 700	37 000	4 800	7 100	51105	
	47	15	16.7	19	0.6	28 000	50 500	3 800	5 600	51205	
	52	18	19.8	22	1	36 000	61 500	3 200	5 000	51305	
30	60	24	26.4	29	1	56 000	89 500	2 600	4 000	51405	
	47	11	—	—	0.6	20 600	42 000	4 300	6 700	51106	
	52	16	17.8	20	0.6	29 500	58 000	3 400	5 300	51206	
35	60	21	22.6	25	1	43 000	78 500	2 800	4 300	51306	
	70	28	30.1	33	1	73 000	126 000	2 200	3 400	51406	
	52	12	—	—	0.6	22 100	49 500	4 000	6 000	51107	
40	62	18	19.9	22	1	39 500	78 000	3 000	4 500	51207	
	68	24	25.6	28	1	56 000	105 000	2 400	3 800	51307	
	80	32	34	37	1.1	87 500	155 000	2 000	3 000	51407	
45	60	13	—	—	0.6	27 100	63 000	3 600	5 300	51108	
	68	19	20.3	23	1	47 500	98 500	2 800	4 300	51208	
	78	26	28.5	31	1	70 000	135 000	2 200	3 400	51308	
50	90	36	38.2	42	1.1	103 000	188 000	1 700	2 600	51408	
	65	14	—	—	0.6	28 100	69 000	3 400	5 000	51109	
	73	20	21.3	24	1	48 000	105 000	2 600	4 000	51209	
50	85	28	30.1	33	1	80 500	163 000	2 000	3 000	51309	
	100	39	42.4	46	1.1	128 000	246 000	1 600	2 400	51409	
	70	14	—	—	0.6	29 000	75 500	3 200	4 800	51110	
50	78	22	23.5	26	1	49 000	111 000	2 400	3 600	51210	
	95	31	34.3	37	1.1	97 500	202 000	1 800	2 800	51310	
50	110	43	45.6	50	1.5	147 000	288 000	1 400	2 200	51410	

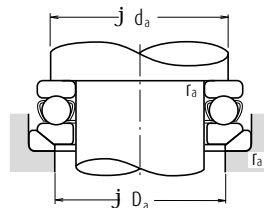
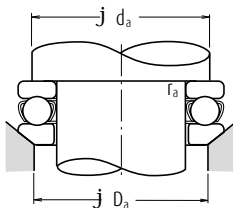
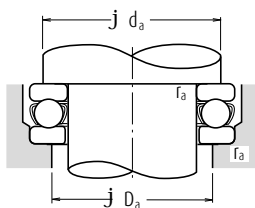

Bearing Numbers		Dimensions (mm)							Abutment and Fillet Dimensions (mm)			Mass (kg) approx.		
With Aligning Seat	With Aligning Seat Washer	d ₁	D ₁	D ₂	D ₃	b	A	R	d _a min.	D _a max.	r _a max.	With Flat Seat	With Aligning Seat	With Aligning Seat Washer
—	—	24	11	—	—	—	—	—	18	16	0.3	0.019	—	—
53200	53200 U	26	12	18	28	3.5	8.5	22	20	16	0.6	0.028	0.029	0.036
—	—	26	13	—	—	—	—	—	20	18	0.3	0.021	—	—
53201	53201 U	28	14	20	30	3.5	11.5	25	22	18	0.6	0.031	0.031	0.039
—	—	28	16	—	—	—	—	—	23	20	0.3	0.023	—	—
53202	53202 U	32	17	24	35	4	12	28	25	22	0.6	0.043	0.048	0.059
—	—	30	18	—	—	—	—	—	25	22	0.3	0.025	—	—
53203	53203 U	35	19	26	38	4	16	32	28	24	0.6	0.050	0.055	0.069
—	—	35	21	—	—	—	—	—	29	26	0.3	0.037	—	—
53204	53204 U	40	22	30	42	5	18	36	32	28	0.6	0.077	0.080	0.096
—	—	42	26	—	—	—	—	—	35	32	0.6	0.056	—	—
53205	53205 U	47	27	36	50	5.5	19	40	38	34	0.6	0.111	0.123	0.151
53305	53305 U	52	27	38	55	6	21	45	41	36	1	0.169	0.182	0.224
53405	53405 U	60	27	42	62	8	19	50	46	39	1	0.334	0.353	0.426
—	—	47	32	—	—	—	—	—	40	37	0.6	0.064	—	—
53206	53206 U	52	32	42	55	5.5	22	45	43	39	0.6	0.137	0.154	0.183
53306	53306 U	60	32	45	62	7	22	50	48	42	1	0.267	0.28	0.336
53406	53406 U	70	32	50	75	9	20	56	54	46	1	0.519	0.535	0.666
—	—	52	37	—	—	—	—	—	45	42	0.6	0.081	—	—
53207	53207 U	62	37	48	65	7	24	50	51	46	1	0.21	0.231	0.292
53307	53307 U	68	37	52	72	7.5	24	56	55	48	1	0.386	0.403	0.488
53407	53407 U	80	37	58	85	10	23	64	62	53	1	0.769	0.785	0.967
—	—	60	42	—	—	—	—	—	52	48	0.6	0.12	—	—
53208	53208 U	68	42	55	72	7	28.5	56	57	51	1	0.27	0.289	0.355
53308	53308 U	78	42	60	82	8.5	28	64	63	55	1	0.536	0.581	0.704
53408	53408 U	90	42	65	95	12	26	72	70	60	1	1.1	1.12	1.38
—	—	65	47	—	—	—	—	—	57	53	0.6	0.143	—	—
53209	53209 U	73	47	60	78	7.5	26	56	62	56	1	0.31	0.333	0.419
53309	53309 U	85	47	65	90	10	25	64	69	61	1	0.672	0.702	0.888
53409	53409 U	100	47	72	105	12.5	29	80	78	67	1	1.46	1.53	1.87
—	—	70	52	—	—	—	—	—	62	58	0.6	0.153	—	—
53210	53210 U	78	52	62	82	7.5	32.5	64	67	61	1	0.378	0.404	0.504
53310	53310 U	95	52	72	100	11	28	72	77	68	1	0.931	1.01	1.27
53410	53410 U	110	52	80	115	14	35	90	86	74	1.5	1.94	1.98	2.41



Single-Direction Thrust Ball Bearings

Bore Diameter 55 – 100 mm

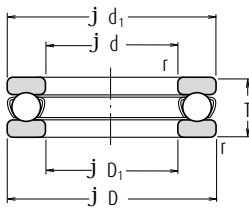

With Flat Seat

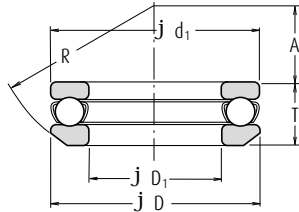

With Aligning Seat

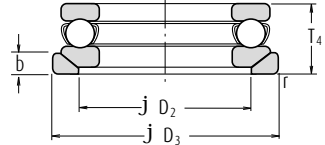

With Aligning Seat Washer

d	Boundary Dimensions (mm)					Basic Load Ratings (N)		Limiting Speeds (min ⁻¹)		With Flat Seat
	D	T	T ₃	T ₄	r min.	C _a	C _{0a}	Grease	Oil	
55	78	16	—	—	0.6	35 000	93 000	2 800	4 300	51111
	90	25	27.3	30	1	70 000	159 000	2 200	3 200	51211
	105	35	39.3	42	1.1	115 000	244 000	1 600	2 400	51311
60	120	48	50.5	55	1.5	181 000	350 000	1 300	1 900	51411
	85	17	—	—	1	41 500	113 000	2 600	4 000	51112
	95	26	28	31	1	71 500	169 000	2 000	3 000	51212
65	110	35	38.3	42	1.1	119 000	263 000	1 600	2 400	51312
	130	51	54	58	1.5	202 000	395 000	1 200	1 800	51412
	90	18	—	—	1	42 000	117 000	2 400	3 800	51113
70	100	27	28.7	32	1	75 500	189 000	1 900	2 800	51213
	115	36	39.4	43	1.1	123 000	282 000	1 500	2 400	51313
	140	56	60.2	65	2	234 000	495 000	1 100	1 700	51413
75	95	18	—	—	1	43 500	127 000	2 400	3 600	51114
	105	27	28.8	32	1	74 000	189 000	1 900	2 800	51214
	125	40	44.2	48	1.1	137 000	315 000	1 400	2 000	51314
80	150	60	63.6	69	2	252 000	555 000	1 000	1 500	51414
	100	19	—	—	1	43 500	131 000	2 200	3 400	51115
	110	27	28.3	32	1	78 000	209 000	1 800	2 800	51215
85	135	44	48.1	52	1.5	159 000	365 000	1 300	1 900	51315
	160	65	69	75	2	254 000	560 000	950	1 400	51415
	105	19	—	—	1	45 000	141 000	2 200	3 400	51116
90	115	28	29.5	33	1	79 000	218 000	1 800	2 600	51216
	140	44	47.6	52	1.5	164 000	395 000	1 300	1 900	51316
	170	68	72.2	78	2.1	272 000	620 000	900	1 300	51416
95	110	19	—	—	1	46 500	150 000	2 200	3 200	51117
	125	31	33.1	37	1	96 000	264 000	1 600	2 400	51217
	150	49	53.1	58	1.5	207 000	490 000	1 100	1 700	51317
100	180	72	77	83	2.1	310 000	755 000	850	1 300	51417 X
	120	22	—	—	1	60 000	190 000	1 900	3 000	51118
	135	35	38.5	42	1.1	114 000	310 000	1 400	2 200	51218
105	155	50	54.6	59	1.5	214 000	525 000	1 100	1 700	51318
	190	77	81.2	88	2.1	330 000	825 000	800	1 200	51418 X
	135	25	—	—	1	86 000	268 000	1 700	2 600	51120
110	150	38	40.9	45	1.1	135 000	375 000	1 300	2 000	51220
	170	55	59.2	64	1.5	239 000	595 000	1 000	1 500	51320
	210	85	90	98	3	370 000	985 000	710	1 100	51420 X

Note (1) The outside diameter d_1 of the shaft washers of all bearing numbers marked X is smaller than the outside diameter D of the housing washers.

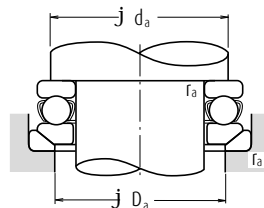
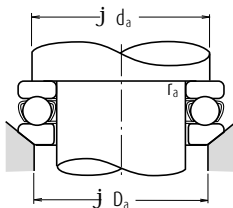
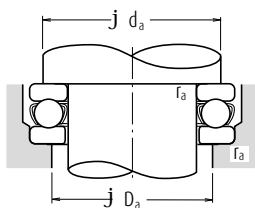

Bearing Numbers (1)		Dimensions (mm)							Abutment and Fillet Dimensions (mm)			Mass (kg) approx.		
With Aligning Seat	With Aligning Seat Washer	d ₁	D ₁	D ₂	D ₃	b	A	R	d _a min.	D _a max.	r _a max.	With Flat Seat	With Aligning Seat	With Aligning Seat Washer
—	—	78	57	—	—	—	—	—	69	64	0.6	0.227	—	—
53211	53211 U	90	57	72	95	9	35	72	76	69	1	0.599	0.656	0.819
53311	53311 U	105	57	80	110	11.5	30	80	85	75	1	1.31	1.45	1.78
53411	53411 U	120	57	88	125	15.5	28	90	94	81	1.5	2.58	2.59	3.16
—	—	85	62	—	—	—	—	—	75	70	1	0.281	—	—
53212	53212 U	95	62	78	100	9	32.5	72	81	74	1	0.673	0.731	0.897
53312	53312 U	110	62	85	115	11.5	41	90	90	80	1	1.4	1.51	1.83
53412	53412 U	130	62	95	135	16	34	100	102	88	1.5	3.16	3.2	3.91
—	—	90	67	—	—	—	—	—	80	75	1	0.324	—	—
53213	53213 U	100	67	82	105	9	40	80	86	79	1	0.756	0.812	0.989
53313	53313 U	115	67	90	120	12.5	38.5	90	95	85	1	1.54	1.67	2.04
53413	53413 U	140	68	100	145	17.5	40	112	110	95	2	4.1	4.22	5.13
—	—	95	72	—	—	—	—	—	85	80	1	0.346	—	—
53214	53214 U	105	72	88	110	9	38	80	91	84	1	0.793	0.866	1.05
53314	53314 U	125	72	98	130	13	43	100	103	92	1	2.0	2.2	2.64
53414	53414 U	150	73	110	155	19.5	34	112	118	102	2	5.05	5.12	6.21
—	—	100	77	—	—	—	—	—	90	85	1	0.389	—	—
53215	53215 U	110	77	92	115	9.5	49	90	96	89	1	0.845	1.27	1.11
53315	53315 U	135	77	105	140	15	37	100	111	99	1.5	2.6	2.8	3.42
53415	53415 U	160	78	115	165	21	42	125	125	110	2	6.15	6.23	7.58
—	—	105	82	—	—	—	—	—	95	90	1	0.417	—	—
53216	53216 U	115	82	98	120	10	46	90	101	94	1	0.931	1.01	1.23
53316	53316 U	140	82	110	145	15	50	112	116	104	1.5	2.74	2.94	3.55
53416	53416 U	170	83	125	175	22	36	125	133	117	2	7.21	7.33	8.9
—	—	110	87	—	—	—	—	—	100	95	1	0.44	—	—
53217	53217 U	125	88	105	130	11	52	100	109	101	1	1.22	1.35	1.63
53317	53317 U	150	88	115	155	17.5	43	112	124	111	1.5	3.57	3.78	4.67
53417 X	53417 XU	177	88	130	185	23	47	140	141	124	2	8.51	8.72	10.4
—	—	120	92	—	—	—	—	—	108	102	1	0.646	—	—
53218	53218 U	135	93	110	140	13.5	45	100	117	108	1	1.69	1.89	2.38
53318	53318 U	155	93	120	160	18	40	112	129	116	1.5	3.83	4.11	5.09
53418 X	53418 XU	187	93	140	195	25.5	40	140	149	131	2	10.2	10.3	12.4
—	—	135	102	—	—	—	—	—	121	114	1	0.96	—	—
53220	53220 U	150	103	125	155	14	52	112	130	120	1	2.25	2.49	3.03
53320	53320 U	170	103	135	175	18	46	125	142	128	1.5	4.98	5.31	6.37
53420 X	53420 XU	205	103	155	220	27	50	160	165	145	2.5	14.8	15	18.1



Single-Direction Thrust Ball Bearings

Bore Diameter 110 – 190 mm

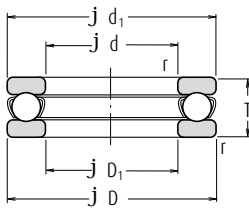

With Flat Seat

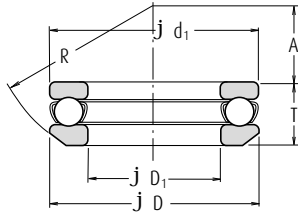

With Aligning Seat

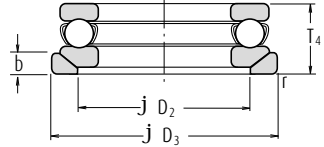

With Aligning Seat Washer

d	Boundary Dimensions (mm)					Basic Load Ratings (N)		Limiting Speeds (min ⁻¹)		With Flat Seat
	D	T	T ₃	T ₄	r min.	C _a	C _{0a}	Grease	Oil	
110	145	25	—	—	1	88 000	288 000	1 700	2 400	51122
	160	38	40.2	45	1.1	136 000	395 000	1 300	1 900	51222
	190	63	67.2	72	2	282 000	755 000	900	1 300	51322 X
120	230	95	99.7	109	3	415 000	1 150 000	630	950	51422 X
	155	25	—	—	1	90 000	310 000	1 600	2 400	51124
	170	39	40.8	46	1.1	141 000	430 000	1 200	1 800	51224
130	210	70	74.1	80	2.1	330 000	930 000	800	1 200	51324 X
	250	102	107.3	118	4	480 000	1 400 000	600	900	51424 X
	170	30	—	—	1	105 000	350 000	1 400	2 000	51126
140	190	45	47.9	53	1.5	183 000	550 000	1 100	1 600	51226 X
	225	75	80.3	86	2.1	350 000	1 030 000	750	1 100	51326 X
	270	110	115.2	128	4	525 000	1 590 000	530	800	51426 X
150	180	31	—	—	1	107 000	375 000	1 300	2 000	51128 X
	200	46	48.6	55	1.5	186 000	575 000	1 000	1 500	51228 X
	240	80	84.9	92	2.1	370 000	1 130 000	670	1 000	51328 X
160	280	112	117	131	4	550 000	1 750 000	530	800	51428 X
	190	31	—	—	1	110 000	400 000	1 300	1 900	51130 X
	215	50	53.3	60	1.5	238 000	735 000	950	1 400	51230 X
170	250	80	83.7	92	2.1	380 000	1 200 000	670	1 000	51330 X
	300	120	125.9	140	4	620 000	2 010 000	480	710	51430 X
	200	31	—	—	1	113 000	425 000	1 200	1 900	51132 X
180	225	51	54.7	61	1.5	249 000	805 000	900	1 400	51232 X
	270	87	91.7	100	3	475 000	1 570 000	600	900	51332 X
	320	130	135.3	150	5	650 000	2 210 000	450	670	51432 X
190	215	34	—	—	1.1	135 000	510 000	1 100	1 700	51134 X
	240	55	58.7	65	1.5	280 000	915 000	850	1 300	51234 X
	280	87	91.3	100	3	465 000	1 570 000	600	900	51334 X
180	340	135	141	156	5	715 000	2 480 000	430	630	51434 X
	225	34	—	—	1.1	136 000	530 000	1 100	1 700	51136 X
	250	56	58.2	66	1.5	284 000	955 000	800	1 200	51236 X
190	300	95	99.3	109	3	480 000	1 680 000	560	850	51336 X
	360	140	148.3	164	5	750 000	2 730 000	400	600	51436 X
	240	37	—	—	1.1	172 000	655 000	1 000	1 600	51138 X
190	270	62	65.7	73	2	320 000	1 110 000	750	1 100	51238 X
	320	105	111	121	4	550 000	1 960 000	500	750	51338 X

Note (1) The outside diameter d_1 of the shaft washers of all bearing numbers marked X is smaller than the outside diameter D of the housing washers.

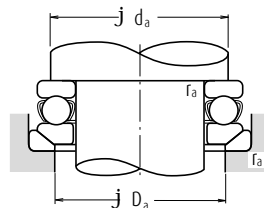
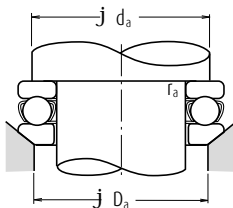
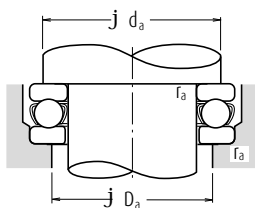

Bearing Numbers (1)		Dimensions (mm)							Abutment and Fillet Dimensions (mm)			Mass (kg) approx.		
With Aligning Seat	With Aligning Seat Washer	d ₁	D ₁	D ₂	D ₃	b	A	R	d _a min.	D _a max.	r _a max.	With Flat Seat	With Aligning Seat	With Aligning Seat Washer
—	—	145	112	—	—	—	—	—	131	124	1	1.04	—	—
53222	53222 U	160	113	135	165	14	65	125	140	130	1	2.42	2.65	3.2
53322 X	53322 XU	187	113	150	195	20.5	51	140	158	142	2	7.19	7.55	9.1
53422 X	53422 XU	225	113	170	240	29	59	180	181	159	2.5	20	20.5	24.3
—	—	155	122	—	—	—	—	—	141	134	1	1.12	—	—
53224	53224 U	170	123	145	175	15	61	125	150	140	1	2.7	2.94	3.58
53324 X	53324 XU	205	123	165	220	22	63	160	173	157	2	9.7	10.1	12.4
53424 X	53424 XU	245	123	185	260	32	70	200	196	174	3	26.2	26.5	31.3
—	—	170	132	—	—	—	—	—	154	146	1	1.68	—	—
53226 X	53226 XU	187	133	160	195	17	67	140	166	154	1.5	3.95	4.35	5.33
53326 X	53326 XU	220	134	177	235	26	53	160	186	169	2	12.1	12.7	15.8
53426 X	53426 XU	265	134	200	280	38	58	200	212	188	3	32.3	32.4	38.8
—	—	178	142	—	—	—	—	—	164	156	1	1.83	—	—
53228 X	53228 XU	197	143	170	210	17	87	160	176	164	1.5	4.3	4.74	5.89
53328 X	53328 XU	235	144	190	250	26	68	180	199	181	2	14.2	16.3	19.5
53428 X	53428 XU	275	144	206	290	38	83	225	222	198	3	34.7	34.8	41.4
—	—	188	152	—	—	—	—	—	174	166	1	1.95	—	—
53230 X	53230 XU	212	153	180	225	20.5	79	160	189	176	1.5	5.52	6.09	7.82
53330 X	53330 XU	245	154	200	260	26	89.5	200	209	191	2	15	17.3	20.5
53430 X	53430 XU	295	154	225	310	41	69	225	238	212	3	43.5	43.8	51.9
—	—	198	162	—	—	—	—	—	184	176	1	2.07	—	—
53232 X	53232 XU	222	163	190	235	21	74	160	199	186	1.5	6.04	6.78	8.7
53332 X	53332 XU	265	164	215	280	29	77	200	225	205	2.5	19.6	22.3	26.7
53432 X	53432 XU	315	164	240	330	41.5	84	250	254	226	4	52.7	52.9	62
—	—	213	172	—	—	—	—	—	197	188	1	2.72	—	—
53234 X	53234 XU	237	173	200	250	21.5	91	180	212	198	1.5	7.41	8.21	10.5
53334 X	53334 XU	275	174	220	290	29	105	225	235	215	2.5	20.3	23.2	28
53434 X	53434 XU	335	174	255	350	46	74	250	269	241	4	61.2	61.3	73
—	—	222	183	—	—	—	—	—	207	198	1	2.79	—	—
53236 X	53236 XU	247	183	210	260	21.5	112	200	222	208	1.5	7.94	8.57	10.8
53336 X	53336 XU	295	184	240	310	32	91	225	251	229	2.5	25.9	29.2	34.9
53436 X	53436 XU	355	184	270	370	46.5	97	280	285	255	4	70.5	72.1	84.9
—	—	237	193	—	—	—	—	—	220	210	1	3.6	—	—
53238 X	53238 XU	267	194	230	280	23	98	200	238	222	2	11.8	12.9	15.7
53338 X	53338 XU	315	195	255	330	33	104	250	266	244	3	36.5	38.1	44.7



Single-Direction Thrust Ball Bearings

Bore Diameter 200 – 360 mm

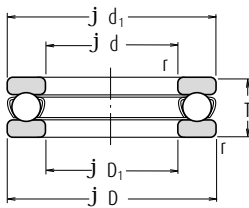

With Flat Seat

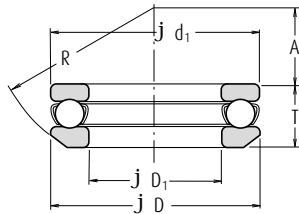

With Aligning Seat

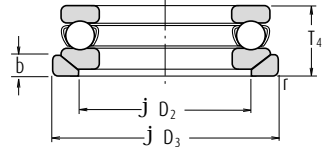

With Aligning Seat Washer

d	Boundary Dimensions (mm)					Basic Load Ratings (N)		Limiting Speeds (min ⁻¹)		With Flat Seat
	D	T	T ₃	T ₄	r min.	C _a	C _{0a}	Grease	Oil	
200	250	37	—	—	1.1	173 000	675 000	1 000	1 500	51140 X
	280	62	65.3	74	2	315 000	1 110 000	710	1 100	51240 X
	340	110	118.4	130	4	600 000	2 220 000	480	710	51340 X
220	270	37	—	—	1.1	179 000	740 000	950	1 500	51144 X
	300	63	65.6	75	2	325 000	1 210 000	670	1 000	51244 X
240	300	45	—	—	1.5	229 000	935 000	850	1 200	51148 X
	340	78	81.6	92	2.1	420 000	1 650 000	560	850	51248 X
260	320	45	—	—	1.5	233 000	990 000	800	1 200	51152 X
	360	79	82.8	93	2.1	435 000	1 800 000	560	850	51252 X
280	350	53	—	—	1.5	315 000	1 310 000	710	1 000	51156 X
	380	80	85	94	2.1	450 000	1 950 000	530	800	51256 X
300	380	62	—	—	2	360 000	1 560 000	600	900	51160 X
	420	95	100.5	112	3	540 000	2 410 000	450	670	51260 X
320	400	63	—	—	2	365 000	1 660 000	600	900	51164 X
	440	95	100.5	112	3	585 000	2 680 000	450	670	51264 X
340	420	64	—	—	2	375 000	1 760 000	560	850	51168 X
	460	96	100.3	113	3	595 000	2 800 000	430	630	51268 X
360	440	65	—	—	2	385 000	1 860 000	560	800	51172 X
	500	110	116.7	130	4	705 000	3 500 000	380	560	51272 X

Note (1) The outside diameter d_1 of the shaft washers of all bearing numbers marked X is smaller than the outside diameter D of the housing washers.

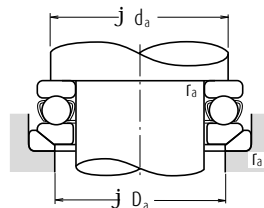
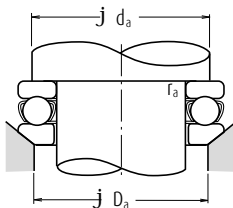
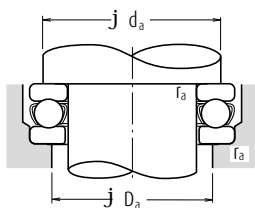

Bearing Numbers (1)		Dimensions (mm)							Abutment and Fillet Dimensions (mm)			Mass (kg) approx.		
With Aligning Seat	With Aligning Seat Washer	d ₁	D ₁	D ₂	D ₃	b	A	R	d _a min.	D _a max.	r _a max.	With Flat Seat	With Aligning Seat	With Aligning Seat Washer
—	—	247	203	—	—	—	—	—	230	220	1	3.75	—	—
53240 X	53240 XU	277	204	240	290	23	125	225	248	232	2	12.3	13.4	16.1
53340 X	53340 XU	335	205	270	350	38	92	250	282	258	3	43.6	46.2	54.8
—	—	267	223	—	—	—	—	—	250	240	1	4.09	—	—
53244 X	53244 XU	297	224	260	310	25	118	225	268	252	2	13.6	14.9	18
—	—	297	243	—	—	—	—	—	276	264	1.5	6.55	—	—
53248 X	53248 XU	335	244	290	350	30	122	250	299	281	2	23.7	25.6	30.7
—	—	317	263	—	—	—	—	—	296	284	1.5	7.01	—	—
53252 X	53252 XU	355	264	305	370	30	152	280	319	301	2	25.1	27.3	33.2
—	—	347	283	—	—	—	—	—	322	308	1.5	12	—	—
53256 X	53256 XU	375	284	325	390	31	143	280	339	321	2	27.1	30.3	37
—	—	376	304	—	—	—	—	—	348	332	2	17.2	—	—
53260 X	53260 XU	415	304	360	430	34	164	320	371	349	2.5	43.5	47.7	56.1
—	—	396	324	—	—	—	—	—	368	352	2	18.6	—	—
53264 X	53264 XU	435	325	380	450	36	157	320	391	369	2.5	45	49.9	59.4
—	—	416	344	—	—	—	—	—	388	372	2	19.9	—	—
53268 X	53268 XU	455	345	400	470	36	199	360	411	389	2.5	47.9	52.7	62
—	—	436	364	—	—	—	—	—	408	392	2	21.5	—	—
53272 X	53272 XU	495	365	430	510	43	172	360	442	418	3	68.8	76.3	90.9



Double-Direction Thrust Ball Bearings

Bore Diameter 10 – 55 mm

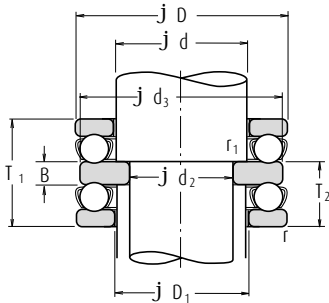

With Flat Seat

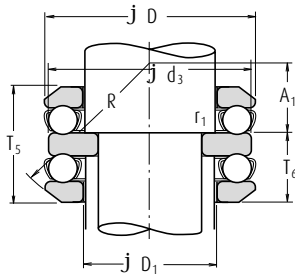

With Aligning Seat

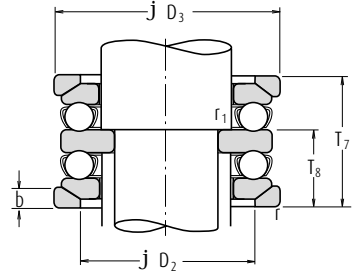

With Aligning Seat Washer

Boundary Dimensions (mm)								Basic Load Ratings (N)		Limiting Speeds (min ⁻¹)		Bearing Numbers	
d ₂	d	D	T ₁	T ₅	T ₇	r min.	r ₁ min.	C _a	C _{0a}	Grease	Oil	With Flat Seat	With Aligning Seat
10	15	32	22	24.6	28	0.6	0.3	16 700	24 800	4 800	7 100	52202	54202
15	20	40	26	27.4	32	0.6	0.3	22 500	37 500	4 000	6 000	52204	54204
	25	60	45	49.8	55	1	0.6	56 000	89 500	2 400	3 600	52405	54405
20	25	47	28	31.4	36	0.6	0.3	28 000	50 500	3 400	5 300	52205	54205
	25	52	34	37.6	42	1	0.3	36 000	61 500	3 000	4 500	52305	54305
30	30	70	52	56.2	62	1	0.6	73 000	126 000	2 200	3 200	52406	54406
	25	30	52	29	32.6	37	0.6	0.3	29 500	58 000	3 200	5 000	52206
30	30	60	38	41.2	46	1	0.3	43 000	78 500	2 600	4 000	52306	54306
	35	80	59	63	69	1.1	0.6	87 500	155 000	1 800	2 800	52407	54407
30	35	62	34	37.8	42	1	0.3	39 500	78 000	2 800	4 300	52207	54207
	35	68	44	47.2	52	1	0.3	56 000	105 000	2 400	3 600	52307	54307
40	40	68	36	38.6	44	1	0.6	47 500	98 500	2 600	3 800	52208	54208
	40	78	49	54	59	1	0.6	70 000	135 000	2 000	3 000	52308	54308
40	40	90	65	69.4	77	1.1	0.6	103 000	188 000	1 700	2 400	52408	54408
	35	45	73	37	39.6	45	1	0.6	48 000	105 000	2 400	3 600	52209
40	45	85	52	56.2	62	1	0.6	80 500	163 000	1 900	2 800	52309	54309
	45	100	72	78.8	86	1.1	0.6	128 000	246 000	1 500	2 200	52409	54409
40	50	78	39	42	47	1	0.6	49 000	111 000	2 400	3 400	52210	54210
	50	95	58	64.6	70	1.1	0.6	97 500	202 000	1 700	2 600	52310	54310
40	50	110	78	83.2	92	1.5	0.6	147 000	288 000	1 400	2 000	52410	54410
	45	55	90	45	49.6	55	1	0.6	70 000	159 000	2 000	3 000	52211
45	55	105	64	72.6	78	1.1	0.6	115 000	244 000	1 500	2 400	52311	54311
	55	120	87	92	101	1.5	0.6	181 000	350 000	1 200	1 800	52411	54411
50	60	95	46	50	56	1	0.6	71 500	169 000	1 900	3 000	52212	54212
	60	110	64	70.6	78	1.1	0.6	119 000	263 000	1 500	2 200	52312	54312
60	60	130	93	99	107	1.5	0.6	202 000	395 000	1 100	1 700	52412	54412
	65	140	101	109.4	119	2	1	234 000	495 000	1 000	1 600	52413	54413
55	65	100	47	50.4	57	1	0.6	75 500	189 000	1 900	2 800	52213	54213
	65	115	65	71.8	79	1.1	0.6	123 000	282 000	1 500	2 200	52313	54313
70	70	105	47	50.6	57	1	1	74 000	189 000	1 800	2 800	52214	54214
	70	125	72	80.4	88	1.1	1	137 000	315 000	1 300	2 000	52314	54314
70	150	107	114.2	125	2	1	252 000	555 000	1 000	1 500	52414	54414	

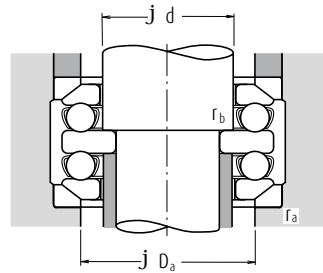
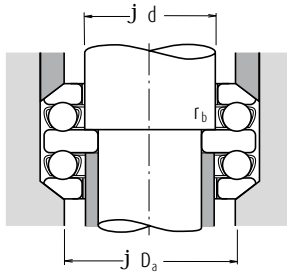
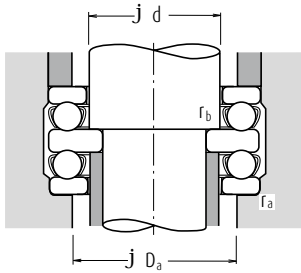

With Aligning Seat Washer	Dimensions (mm)											Abutment and Fillet Dimensions (mm)			Mass (kg) approx.		
	d ₃	D ₁	D ₂	D ₃	T ₂	T ₆	T ₈	B	b	A ₁	R	D _a max.	r _a max.	r _b max.	With Flat Seat	With Aligning Seat	With Aligning Seat Washer
54202 U	32	17	24	35	13.5	14.8	16.5	5	4	10.5	28	24	0.6	0.3	0.081	0.090	0.113
54204 U	40	22	30	42	16	16.7	19	6	5	16	36	30	0.6	0.3	0.148	0.151	0.185
54405 U	60	27	42	62	28	30.4	33	11	8	15	50	42	1	0.6	0.641	0.68	0.825
54205 U	47	27	36	50	17.5	19.2	21.5	7	5.5	16.5	40	36	0.6	0.3	0.213	0.236	0.293
54305 U	52	27	38	55	21	22.8	25	8	6	18	45	38	1	0.3	0.324	0.35	0.434
54406 U	70	32	50	75	32	34.1	37	12	9	16	56	50	1	0.6	0.978	1.01	1.27
54206 U	52	32	42	55	18	19.8	22	7	5.5	20	45	42	0.6	0.3	0.254	0.288	0.345
54306 U	60	32	45	62	23.5	25.1	27.5	9	7	19.5	50	45	1	0.3	0.483	0.511	0.621
54407 U	80	37	58	85	36.5	38.5	41.5	14	10	18.5	64	58	1	0.6	1.43	1.47	1.83
54207 U	62	37	48	65	21	22.9	25	8	7	21	50	48	1	0.3	0.406	0.447	0.57
54307 U	68	37	52	72	27	28.6	31	10	7.5	21	56	52	1	0.3	0.71	0.744	0.915
54208 U	68	42	55	72	22.5	23.8	26.5	9	7	25	56	55	1	0.6	0.543	0.581	0.713
54308 U	78	42	60	82	30.5	33	35.5	12	8.5	23.5	64	60	1	0.6	1.04	1.13	1.38
54408 U	90	42	65	95	40	42.2	46	15	12	22	72	65	1	0.6	1.98	2.02	2.54
54209 U	73	47	60	78	23	24.3	27	9	7.5	23	56	60	1	0.6	0.606	0.652	0.823
54309 U	85	47	65	90	32	34.1	37	12	10	21	64	65	1	0.6	1.28	1.34	1.71
54409 U	100	47	72	105	44.5	47.9	51.5	17	12.5	23.5	80	72	1	0.6	2.71	2.85	3.53
54210 U	78	52	62	82	24	25.5	28	9	7.5	30.5	64	62	1	0.6	0.697	0.75	0.949
54310 U	95	52	72	100	36	39.3	42	14	11	23	72	72	1	0.6	1.78	1.94	2.46
54410 U	110	52	80	115	48	50.6	55	18	14	30	90	80	1.5	0.6	3.51	3.59	4.45
54211 U	90	57	72	95	27.5	29.8	32.5	10	9	32.5	72	72	1	0.6	1.11	1.22	1.55
54311 U	105	57	80	110	39.5	43.8	46.5	15	11.5	25.5	80	80	1	0.6	2.43	2.7	3.35
54411 U	120	57	88	125	53.5	56	60.5	20	15.5	22.5	90	88	1.5	0.6	4.66	4.68	5.82
54212 U	95	62	78	100	28	30	33	10	9	30.5	72	78	1	0.6	1.22	1.33	1.66
54312 U	110	62	85	115	39.5	42.8	46.5	15	11.5	36.5	90	85	1	0.6	2.59	2.82	3.45
54412 U	130	62	95	135	57	60	64	21	16	28	100	95	1.5	0.6	5.74	5.82	7.24
54413 U	140	68	100	145	62	66.2	71	23	17.5	34	112	100	2	1	7.41	7.66	9.47
54213 U	100	67	82	105	28.5	30.2	33.5	10	9	38.5	80	82	1	0.6	1.34	1.45	1.81
54313 U	115	67	90	120	40	43.4	47	15	12.5	34.5	90	90	1	0.6	2.8	3.06	3.8
54214 U	105	72	88	110	28.5	30.3	33.5	10	9	36.5	80	88	1	1	1.44	1.59	1.95
54314 U	125	72	98	130	44	48.2	52	16	13	39	100	98	1	1	3.67	4.07	4.95
54414 U	150	73	110	155	65.5	69.1	74.5	24	19.5	28.5	112	110	2	1	8.99	9.12	11.3



Double-Direction Thrust Ball Bearings

Bore Diameter 60 – 130 mm

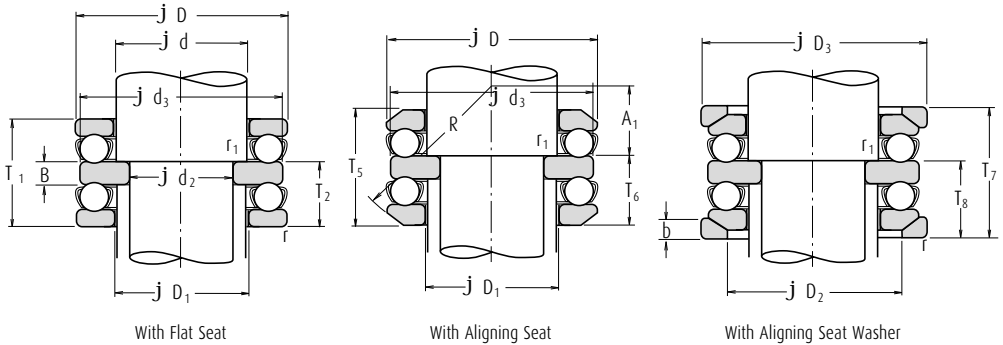

Boundary Dimensions (mm)							Basic Load Ratings (N)		Limiting Speeds (min ⁻¹)		Bearing Numbers ⁽¹⁾		
d ₂	d	D	T ₁	T ₅	T ₇	r min.	r ₁ min.	C _a	C _{0a}	Grease	Oil	With Flat Seat	With Aligning Seat
60	75	110	47	49.6	57	1	1	78 000	209 000	1 800	2 600	52215	54215
	75	135	79	87.2	95	1.5	1	159 000	365 000	1 200	1 800	52315	54315
75	160	115	123	135	2	1	254 000	560 000	900	1 400	52415	54415	
	80	115	48	51	58	1	1	79 000	218 000	1 700	2 600	52216	54216
65	80	140	79	86.2	95	1.5	1	164 000	395 000	1 200	1 800	52316	54316
	80	170	120	128.4	140	2.1	1	272 000	620 000	850	1 300	52416	54416
85	180	128	138	150	2.1	1.1	310 000	755 000	800	1 200	52417 X	54417 X	
	85	125	55	59.2	67	1	1	96 000	264 000	1 500	2 200	52217	54217
70	85	150	87	95.2	105	1.5	1	207 000	490 000	1 100	1 600	52317	54317
	90	190	135	143.4	157	2.1	1.1	330 000	825 000	750	1 100	52418 X	54418 X
75	90	135	62	69	76	1.1	1	114 000	310 000	1 400	2 000	52218	54218
	90	155	88	97.2	106	1.5	1	214 000	525 000	1 100	1 600	52318	54318
80	100	210	150	160	176	3	1.1	370 000	985 000	670	1 000	52420 X	54420 X
	85	100	150	67	72.8	81	1.1	1	135 000	375 000	1 300	1 900	52220
100	100	170	97	105.4	115	1.5	1	239 000	595 000	950	1 500	52320	54320
	110	230	166	—	—	3	1.1	415 000	1 150 000	600	900	52422 X	—
95	110	160	67	71.4	81	1.1	1	136 000	395 000	1 200	1 800	52222	54222
	110	190	110	118.4	128	2	1	282 000	755 000	850	1 300	52322 X	54322 X
120	120	250	177	—	—	4	1.5	515 000	1 540 000	560	850	52424 X	—
	100	120	170	68	71.6	82	1.1	1.1	141 000	430 000	1 200	1 800	52224
120	210	123	131.2	143	2.1	1.1	330 000	930 000	750	1 100	52324 X	54324 X	
	130	270	192	—	—	4	1.5	525 000	1 590 000	530	800	52426 X	—
110	130	190	80	85.8	96	1.5	1.1	183 000	550 000	1 000	1 500	52226 X	54226 X
	130	225	130	—	—	2.1	1.1	350 000	1 030 000	710	1 100	52326 X	—
140	280	196	—	—	—	4	1.5	550 000	1 750 000	500	750	52428 X	—
	120	140	200	81	86.2	99	1.5	1.1	186 000	575 000	1 000	1 500	52228 X
140	240	140	—	—	—	2.1	1.1	370 000	1 130 000	670	1 000	52328 X	—
	150	300	209	—	—	4	2	620 000	2 010 000	480	710	52430 X	—
130	150	215	89	95.6	109	1.5	1.1	238 000	735 000	900	1 300	52230 X	54230 X
	150	250	140	—	—	2.1	1.1	380 000	1 200 000	630	950	52330 X	—
160	320	226	—	—	—	5	2	650 000	2 210 000	430	630	52432 X	—

Note ⁽¹⁾ The outside diameter d_3 of the central washers of all bearing numbers marked X is smaller than the outside diameter D of the housing washers.

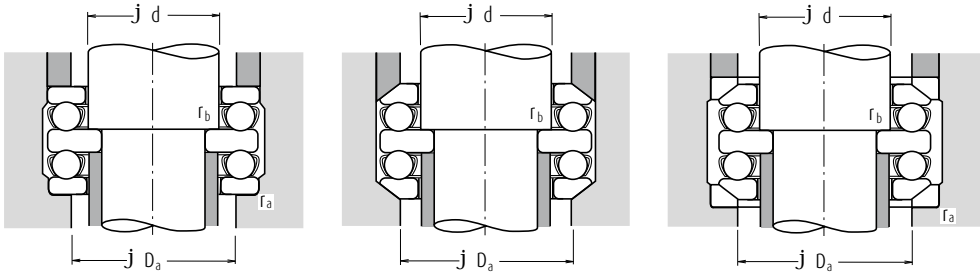

	Dimensions (mm)												Abutment and Fillet Dimensions (mm)			Mass (kg) approx.				
	With Aligning Seat Washer	d_3	D_1	D_2	D_3	T_2	T_6	T_8	B	b	A_1	R	D_a max.	r_a max.	r_b max.	With Flat Seat	With Aligning Seat	With Aligning Seat Washer		
54215 U	110	77	92	115	28.5	29.8	33.5	10	9.5	47.5	90	92	1	1	1.54	1.66	2.06			
54315 U	135	77	105	140	48.5	52.6	56.5	18	15	32.5	100	105	1.5	1	4.74	5.14	6.38			
54415 U	160	78	115	165	70.5	74.5	80.5	26	21	36.5	125	115	2	1	10.8	11	13.7			
54216 U	115	82	98	120	29	30.5	34	10	10	45	90	98	1	1	1.66	1.78	2.21			
54316 U	140	82	110	145	48.5	52.1	56.5	18	15	45.5	112	110	1.5	1	4.99	5.39	6.61			
54416 U	170	83	125	175	73.5	77.7	83.5	27	22	30.5	125	125	2	1	12.6	12.8	16			
54417 XU	179.5	88	130	185	78.5	83.5	89.5	29	23	40.5	140	130	2	1	15.4	15.8	19.5			
54217 U	125	88	105	130	33.5	35.6	39.5	12	11	49.5	100	105	1	1	2.26	2.45	3.02			
54317 U	150	88	115	155	53	57.1	62	19	17.5	39	112	115	1.5	1	6.38	6.8	10.5			
54418 XU	189.5	93	140	195	82.5	86.7	93.5	30	25.5	34.5	140	140	2	1	17.5	18.1	22.5			
54218 U	135	93	110	140	38	41.5	45	14	13.5	42	100	110	1	1	3.09	3.42	4.39			
54318 U	155	93	120	160	53.5	58.1	62.5	19	18	36.5	112	120	1.5	1	6.79	7.33	9.29			
54420 XU	209.5	103	155	220	91.5	96.5	104.5	33	27	43.5	160	155	2.5	1	26.8	27.2	33.4			
54220 U	150	103	125	155	41	43.9	48	15	14	49	112	125	1	1	4.08	4.54	5.64			
54320 U	170	103	135	175	59	63.2	68	21	18	42	125	135	1.5	1	8.82	9.47	11.6			
—	229	113	—	—	101.5	—	—	37	—	—	—	—	—	—	159	2.5	1	35.6	—	—
54222 U	160	113	135	165	41	43.2	48	15	14	62	125	135	1	1	4.39	4.83	5.94			
54322 XU	189.5	113	150	195	67	71.2	76	24	20.5	47	140	150	2	1	12.7	13.5	16.6			
—	249	123	—	—	108.5	—	—	40	—	—	—	—	—	—	174	3	1.5	47.6	—	—
54224 U	170	123	145	175	41.5	43.3	48.5	15	15	58.5	125	145	1	1	4.92	5.4	6.68			
54324 XU	209.5	123	165	220	75	79.1	85	27	22	58	160	165	2	1	17.6	16.4	22.9			
—	269	134	—	—	117	—	—	42	—	—	—	—	—	—	188	3	1.5	57.8	—	—
54226 XU	189.5	133	160	195	49	51.9	57	18	17	63	140	160	1.5	1	7.43	8.24	10.2			
—	224	134	—	—	80	—	—	30	—	—	—	—	—	—	169	2	1	21.5	—	—
—	279	144	—	—	120	—	—	44	—	—	—	—	—	—	198	3	1.5	62.4	—	—
54228 XU	199.5	143	170	210	49.5	52.1	58.5	18	17	83.5	160	170	1.5	1	8.01	8.87	11.2			
—	239	144	—	—	85.5	—	—	31	—	—	—	—	—	—	181	2	1	24.8	—	—
—	299	153	—	—	127.5	—	—	46	—	—	—	—	—	—	212	3	2	77.8	—	—
54230 XU	214.5	153	180	225	54.5	57.8	64.5	20	20.5	74.5	160	180	1.5	1	10.4	11.5	15			
—	249	154	—	—	85.5	—	—	31	—	—	—	—	—	—	191	2	1	30.3	—	—
—	319	164	—	—	138	—	—	50	—	—	—	—	—	—	226	4	2	93.6	—	—



Double-Direction Thrust Ball Bearings

Bore Diameter 135 – 190 mm

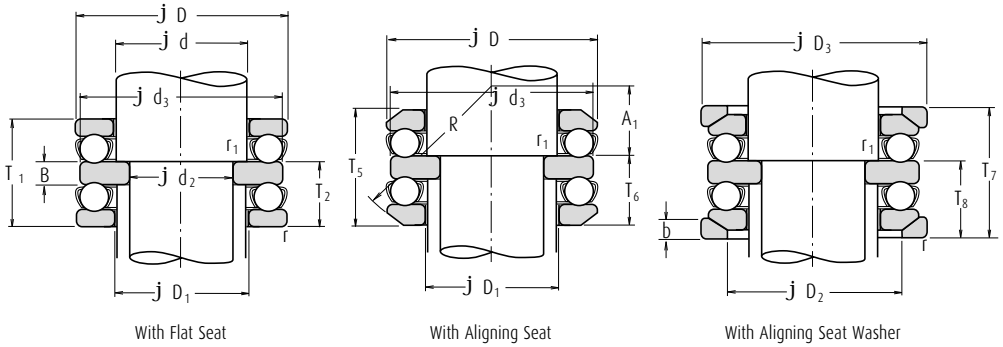

Boundary Dimensions (mm)								Basic Load Ratings (N)		Limiting Speeds (min ⁻¹)		Bearing Numbers ⁽¹⁾	
d ₂	d	D	T ₁	T ₅	T ₇	r min.	r ₁ min.	C _a	C _{0a}	Grease	Oil	With Flat Seat	With Aligning Seat
135	170	340	236	—	—	5	2.1	715 000	2 480 000	400	600	52434 X	—
140	160	225	90	97.4	110	1.5	1.1	249 000	805 000	850	1 300	52232 X	54232 X
	160	270	153	—	—	3	1.1	475 000	1 570 000	600	900	52332 X	—
	180	360	245	—	—	5	3	750 000	2 730 000	380	560	52436 X	—
150	170	240	97	104.4	117	1.5	1.1	280 000	915 000	800	1 200	52234 X	54234 X
	170	280	153	—	—	3	1.1	465 000	1 570 000	560	850	52334 X	—
	180	250	98	102.4	118	1.5	2	284 000	955 000	800	1 200	52236 X	54236 X
	180	300	165	—	—	3	3	480 000	1 680 000	530	800	52336 X	—
160	190	270	109	116.4	131	2	2	320 000	1 110 000	710	1 100	52238 X	54238 X
	190	320	183	—	—	4	2	550 000	1 960 000	480	710	52338 X	—
170	200	280	109	115.6	133	2	2	315 000	1 110 000	710	1 000	52240 X	54240 X
	200	340	192	—	—	4	2	600 000	2 220 000	450	670	52340 X	—
190	220	300	110	115.2	134	2	2	325 000	1 210 000	670	1 000	52244 X	54244 X

Note ⁽¹⁾ The outside diameter d_3 of the central washers of all bearing numbers marked X is smaller than the outside diameter D of the housing washers.

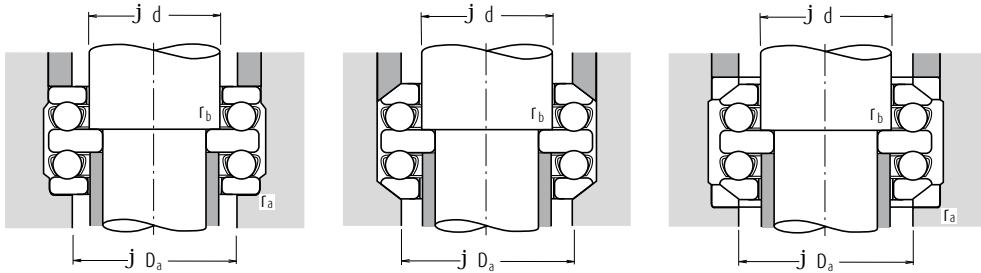

With Aligning Seat Washer	Dimensions (mm)												Abutment and Fillet Dimensions (mm)			Mass (kg) approx.		
	d_3	D_1	D_2	D_3	T_2	T_6	T_8	B	b	A_1	R	D_a max.	r_a max.	r_b max.	With Flat Seat	With Aligning Seat	With Aligning Seat Washer	
—	339	174	—	—	143	—	—	50	—	—	—	240	4	2	110	—	—	
54232 XU	224.5	163	190	235	55	58.7	65	20	21	70	160	190	1.5	1	11.2	12.7	16.5	
—	269	164	—	—	93	—	—	33	—	—	—	205	2.5	1	35.1	—	—	
—	359	184	—	—	148.5	—	—	52	—	—	—	254	4	2.5	126	—	—	
54234 XU	239.5	173	200	250	59	62.7	69	21	21.5	87	180	200	1.5	1	13.6	15.2	19.8	
—	279	174	—	—	93	—	—	33	—	—	—	215	2.5	1	40.8	—	—	
54236 XU	249	183	210	260	59.5	61.7	69.5	21	21.5	108.5	200	210	1.5	2	14.8	16.1	20.6	
—	299	184	—	—	101	—	—	37	—	—	—	229	2.5	2.5	46.3	—	—	
54238 XU	269	194	230	280	66.5	70.2	77.5	24	23	93.5	200	230	2	2	22.1	22.2	29.8	
—	319	195	—	—	111.5	—	—	40	—	—	—	244	3	2	113	—	—	
54240 XU	279	204	240	290	66.5	69.8	78.5	24	23	120.5	225	240	2	2	23.1	23.2	30.6	
—	339	205	—	—	117	—	—	42	—	—	—	258	3	2	78.4	—	—	
54244 XU	299	224	260	310	67	69.6	79	24	25	114	225	260	2	2	25.2	27.8	34.1	



Thrust Cylindrical Roller Bearings



9. THRUST CYLINDRICAL ROLLER BEARINGS

Introduction.....	Page B 332
-------------------	---------------

BEARINGS TABLE

THRUST CYLINDRICAL ROLLER BEARINGS

Bore Dia.	Page
35 - 320 mm.....	B 334



Thrust Cylindrical Roller Bearings

DESIGN, TYPES, AND FEATURES

THRUST CYLINDRICAL ROLLER BEARINGS

These are thrust bearings containing cylindrical rollers. They can sustain only axial loads, but they are suitable for heavy loads and have high axial rigidity. The cages are machined brass.

TOLERANCES AND RUNNING ACCURACY

Thrust Cylindrical Roller Bearings.....According to Table 7.6 (Pages A140 to A142)

RECOMMENDED FITS

Thrust Cylindrical Roller Bearings..... Table 8.4 (Page A164)
Table 8.6 (Page A165)

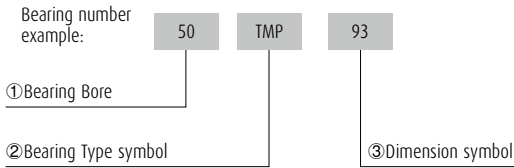



MINIMUM AXIAL LOAD

It is necessary to apply some axial load to thrust bearings to prevent slippage between the rolling elements and raceways. For more details, please contact NSK.



Thrust Cylindrical Roller Bearings

Bore Diameter 35 – 130 mm

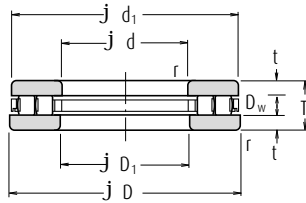

Boundary Dimensions (mm)				Basic Load Ratings (N)		Limiting Speeds (min ⁻¹)	
d	D	T	r min.	C _a	C _{0a}	Grease	Oil
35	80	32	1.1	95 000	247 000	1 000	3 000
40	78	22	1	63 000	194 000	1 200	3 600
45	65	14	0.6	33 000	100 000	1 700	5 000
	85	24	1	71 000	233 000	1 100	3 400
50	110	27	1.1	139 000	470 000	900	2 800
	95	27	1.1	113 000	350 000	1 000	3 000
55	105	30	1.1	134 000	450 000	900	2 600
60	95	26	1	99 000	325 000	1 000	3 000
	110	30	1.1	139 000	480 000	850	2 600
65	100	27	1	110 000	325 000	950	2 800
	115	30	1.1	145 000	515 000	850	2 600
70	150	36	2	259 000	935 000	670	2 000
	125	34	1.1	191 000	635 000	750	2 200
75	100	19	1	63 500	221 000	1 100	3 400
	135	36	1.5	209 000	735 000	710	2 200
80	115	28	1	120 000	420 000	900	2 600
	140	36	1.5	208 000	740 000	710	2 000
85	110	19	1	75 000	298 000	1 100	3 200
	125	31	1	151 000	485 000	800	2 400
90	150	39	1.5	257 000	995 000	630	1 900
	120	22	1	96 000	370 000	950	3 000
100	155	39	1.5	250 000	885 000	630	1 900
	170	42	1.5	292 000	1 110 000	560	1 700
110	160	38	1.1	228 000	855 000	630	1 900
	190	48	2	390 000	1 490 000	500	1 500
120	170	39	1.1	233 000	895 000	600	1 800
	210	54	2.1	505 000	1 930 000	450	1 400
130	190	45	1.5	300 000	1 090 000	530	1 600
	225	58	2.1	585 000	2 370 000	430	1 300
	270	85	4	895 000	3 300 000	320	950

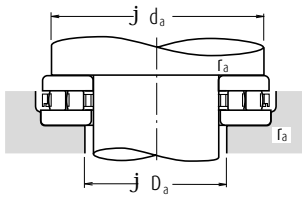

Bearing Numbers	Dimensions (mm)				Abutment and Fillet Dimensions (mm)			Mass (kg) approx.
	d_1	D_1	D_w	t	d_a min.	D_a max.	r_a max.	
35 TMP 14	80	37	12	10	71	46	1	0.97
40 TMP 93	78	42	8	7	71	48	1	0.525
45 TMP 11	65	47	6	4	60	49	0.6	0.144
45 TMP 93	85	47	8	8	78	53	1	0.665
50 TMP 74	109	52	11	8	100	61	1	1.52
50 TMP 93	93	52	11	8	89	57	1	0.94
55 TMP 93	105	55.2	11	9.5	98	63	1	1.28
60 TMP 12	95	62	10	8	88	67	1	0.735
60 TMP 93	110	62	11	9.5	103	68	1	1.36
65 TMP 12	100	67	12.5	7.25	93	71	1	0.805
65 TMP 93	115	65.2	11	9.5	108	73	1	1.44
70 TMP 74	149	72	15	10.5	137	84	2	3.8
70 TMP 93	125	72	14	10	117	78	1	1.95
75 TMP 11	100	77	8	5.5	96	79	1	0.41
75 TMP 93	135	77	14	11	125	84	1.5	2.42
80 TMP 12	115	82	11	8.5	109	86	1	1.02
80 TMP 93	138	82	14	11	130	91	1.5	2.54
85 TMP 11	110	87	7.5	5.75	105	89	1	0.46
85 TMP 12	125	88	14	8.5	118	92	1	1.36
85 TMP 93	148	87	14	12.5	140	95	1.5	3.2
90 TMP 11	119	91.5	9	6.5	114	95	1	0.725
90 TMP 93	155	90.2	16	11.5	144	101	1.5	3.3
100 TMP 93	170	103	16	13	159	110	1.5	4.25
110 TMP 12	160	113	15	11.5	150	119	1	2.66
110 TMP 93	190	113	19	14.5	179	120	2	6.15
120 TMP 12	170	123	15	12	160	129	1	2.93
120 TMP 93	210	123	22	16	199	129	2	8.55
130 TMP 12	187	133	19	13	177	142	1.5	4.5
130 TMP 93	225	133	22	18	214	140	2	10.4
130 TMP 94	270	133	32	26.5	254	150	3	26.2

Remark For cylindrical roller thrust bearings not listed above, please contact NSK.

Thrust Cylindrical Roller Bearings

Bore Diameter 140 – 320 mm

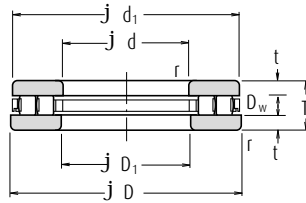

Boundary Dimensions (mm)				Basic Load Ratings (N)		Limiting Speeds (min ⁻¹)	
d	D	T	r min.	C _a	C _{0a}	Grease	Oil
140	200	46	2	285 000	1 120 000	500	1 500
	240	60	2.1	610 000	2 360 000	400	1 200
	280	85	4	990 000	3 800 000	300	900
150	215	50	2	375 000	1 500 000	480	1 400
	250	60	2.1	635 000	2 510 000	400	1 200
160	200	31	1	173 000	815 000	630	1 900
	270	67	3	745 000	3 150 000	360	1 100
170	240	55	1.5	485 000	1 960 000	430	1 300
	280	67	3	800 000	3 500 000	340	1 000
180	300	73	3	1 000 000	4 000 000	320	950
	360	109	5	1 640 000	6 200 000	240	710
190	270	62	3	705 000	2 630 000	360	1 100
	320	78	4	1 080 000	4 500 000	300	900
200	250	37	1.1	365 000	1 690 000	500	1 500
	340	85	4	1 180 000	5 150 000	280	800
220	270	37	1.1	385 000	1 860 000	480	1 500
	300	63	2	770 000	3 100 000	340	1 000
240	300	45	1.5	435 000	2 160 000	400	1 200
	340	78	2.1	965 000	4 100 000	280	850
260	320	45	1.5	460 000	2 350 000	400	1 200
	360	79	2.1	995 000	4 350 000	280	850
280	350	53	1.5	545 000	2 800 000	340	1 000
	380	80	2.1	1 050 000	4 750 000	260	800
300	380	62	2	795 000	4 000 000	300	900
	420	95	3	1 390 000	6 250 000	220	670
320	400	63	2	820 000	4 250 000	300	900
	440	95	3	1 420 000	6 550 000	220	670

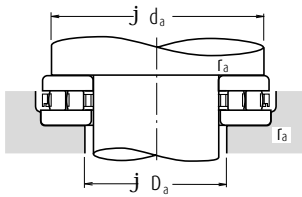

Bearing Numbers	Dimensions (mm)				Abutment and Fillet Dimensions (mm)			Mass (kg) approx.
	d_1	D_1	D_w	t	d_a min.	D_a max.	r_a max.	
140 TMP 12	197	143	17	14.5	188	153	2	4.85
140 TMP 93	240	143	25	17.5	226	154	2	12.2
140 TMP 94	280	143	32	26.5	262	158	3	27.5
150 TMP 12	215	153	19	15.5	202	163	2	6.15
150 TMP 93	250	153	25	17.5	236	165	2	12.8
160 TMP 11	200	162	11	10	191	168	1	2.21
160 TMP 93	265	164	25	21	255	173	2.5	16.9
170 TMP 12	237	173	22	16.5	227	182	1.5	8.2
170 TMP 93	280	173	25	21	265	183	2.5	17.7
180 TMP 93	300	185	32	20.5	284	194	2.5	22.5
180 TMP 94	354	189	45	32	335	205	4	58.2
190 TMP 12	266	195	30	16	255	200	2.5	11.8
190 TMP 93	320	195	32	23	303	205	3	27.6
200 TMP 11	247	203	17	10	242	207	1	4.1
200 TMP 93	340	205	32	26.5	322	218	3	34.5
220 TMP 11	267	223	17	10	262	227	1	4.5
220 TMP 12	297	224	30	16.5	287	232	2	13.5
240 TMP 11	297	243	18	13.5	288	251	1.5	7.2
240 TMP 12	335	244	32	23	322	258	2	23.3
260 TMP 11	317	263	18	13.5	308	272	1.5	7.75
260 TMP 12	355	264	32	23.5	342	276	2	25.2
280 TMP 11	347	283	20	16.5	335	294	1.5	11.6
280 TMP 12	375	284	32	24	362	296	2	27.2
300 TMP 11	376	304	25	18.5	365	315	2	16.7
300 TMP 12	415	304	38	28.5	398	322	2.5	42
320 TMP 11	396	324	25	19	385	335	2	18
320 TMP 12	435	325	38	28.5	418	340	2.5	44.5

Remark For cylindrical roller thrust bearings not listed above, please contact NSK.

Thrust Tapered Roller Bearings



10. THRUST TAPERED ROLLER BEARINGS

Introduction.....	Page B 340
-------------------	---------------

BEARINGS TABLE

THRUST TAPERED ROLLER BEARINGS

Bore Dia.	Page
101.600 – 600 mm	B 342



Thrust Tapered Roller Bearings

DESIGN, TYPES, AND FEATURES

THRUST TAPERED ROLLER BEARINGS

These are thrust bearings containing tapered rollers. TT-type bearings, which have a rib on the housing washer, can accurately guide the shaft in the radial direction. TTF-type bearings, which have no rib on the housing washer, can tolerate some eccentricity during operation.



Fig 1 TT, TTF Base Structure

TOLERANCES AND RUNNING ACCURACY

Thrust Tapered Roller Bearings..... Table 7.7 (Page A144)

RECOMMENDED FITS

Thrust Tapered Roller Bearings..... Table 8.4 (Pages A164)
Table 8.6 (Pages A165)

For inch design tapered roller thrust bearings, please contact NSK.

MINIMUM AXIAL LOAD

It is necessary to apply some axial load to thrust bearings to prevent slippage between the rolling elements and raceways. For more details, please contact NSK.

USAGE EXAMPLE

Typical structure of Heavy Duty Extruder is shown in Figure 2.

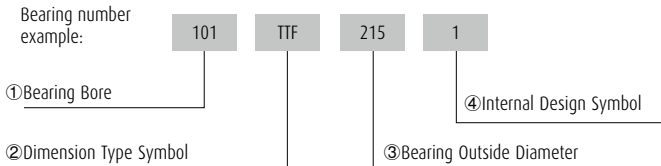

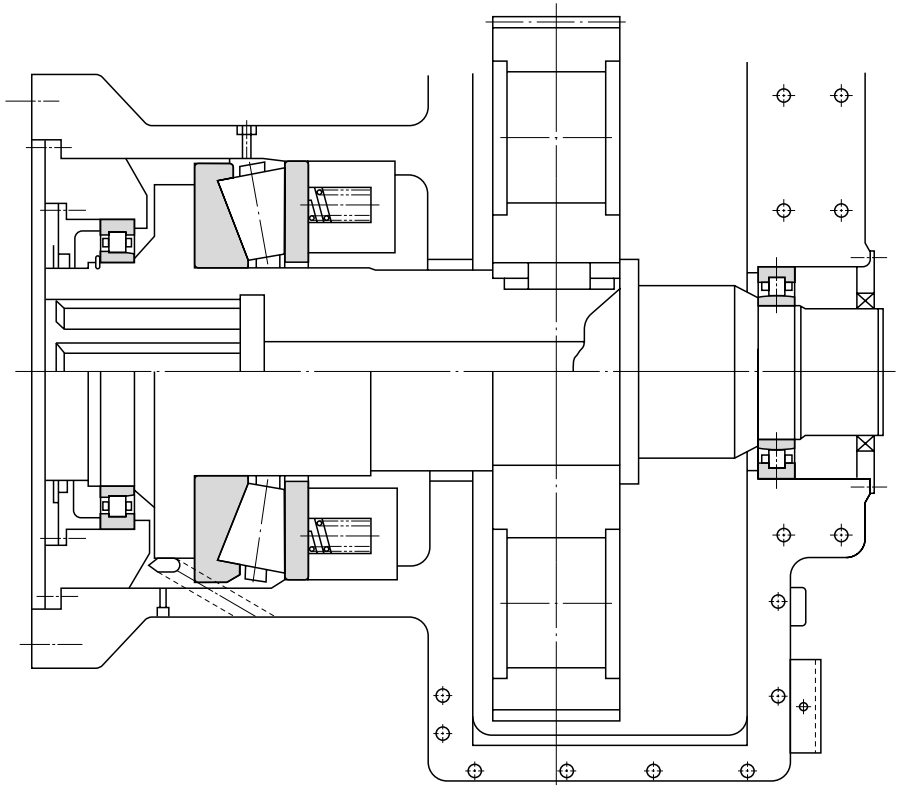
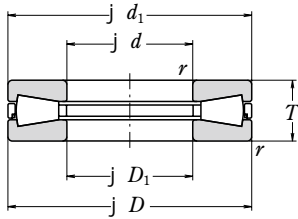

Figure 2 Thrust Tapered Roller Bearing in Heavy Duty Extruder

Thrust Tapered Roller Bearings

TT, TTF Types

Bore Diameter 101.600 – 168.275 mm



TT

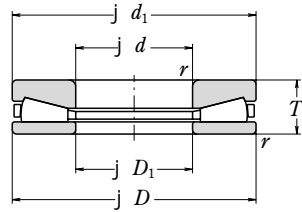

TTF

Boundary Dimensions (mm/inch)				Basic Load Ratings (kN)		Bearing Numbers
d	D	T	r min.	C _a	C _{0a}	
101.600	215.900	46.038	3.3	710	2 900	*101TT2151
4.0000	8.5000	1.8125	3.3	710	2 900	*101TT2151
111.760	223.520	55.880	3.3	790	2 920	*111TT2251
4.4000	8.8000	2.2000	3.3	790	2 920	*111TT2251
114.300	250.825	53.975	4.0	970	4 100	*114TT2551
4.5000	9.8750	2.1250	4.0	970	4 100	*114TT2551
127.000	266.700	58.738	4.8	1 040	4 350	*127TT2551
5.0000	10.5000	2.3125	4.8	1 040	4 350	*127TT2551
	266.700	58.738	4.8	1 030	4 500	*127TTF2651
	10.5000	2.3125	4.8	1 030	4 500	*127TTF2651
128.575	265.100	63.500	6.4	1 040	4 350	*128TT2651
5.0620	10.4370	2.5000	6.4	1 040	4 350	*128TT2651
130	250	70	2.1	1 100	4 100	130TTF2501
135	245	65	2.1	855	3 100	135TT2401
150	300	90	5	1 470	6 300	150TTF3001
152.400	317.500	69.850	6.4	1 470	6 330	*152TTF3151
6.0000	12.5000	2.7500	6.4	1 470	6 300	*152TTF3151
	317.500	69.850	6.4	1 550	6 700	*152TT3152
	12.2500	2.7500	6.4	1 550	6 700	*152TT3152
165.100	311.150	88.900	6.4	1 560	5 250	*165TT3151
6.5000	12.2500	3.5000	6.4	1 560	5 250	*165TT3151
168.275	304.800	69.850	6.4	1 230	5 000	*168TTF3051
6.6250	12.0000	2.7500	6.4	1 230	5 000	*168TTF3051

Dimensions (mm)		Corner Radius of Shaft or Housing	Mass (kg)
D ₁	d ₁	r _a	approx.
103.200	214.300	3.3	8.9
103.200	214.300	3.3	8.9
113.300	221.900	3.3	11.2
113.300	221.900	3.3	11.2
114.500	250.825	4.0	14.4
114.500	250.825	4.0	14.4
128.600	265.100	4.8	17.3
128.600	265.100	4.8	17.3
128.600	265.100	4.8	17.3
128.600	265.100	4.8	17.3
128.900	265.100	6.4	18.2
128.900	265.100	6.4	18.2
130.3	250	2	17
135.3	245	2	14.5
152	306	4	34.2
152.700	315.900	6.4	28.9
152.700	315.900	6.4	28.9
152.400	317.500	6.4	28.9
152.400	317.500	6.4	28.9
165.400	311.150	6.4	33
165.400	311.150	6.4	33
169.000	302.500	6.4	24.1
169.000	302.500	6.4	24.1

Note * Bearings marked * are inch design.



Thrust Tapered Roller Bearings

TT, TTF Types
Bore Diameter 170 - 241.300 mm

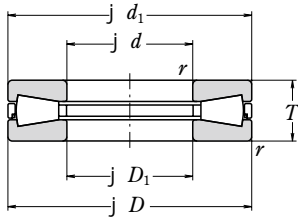

TT

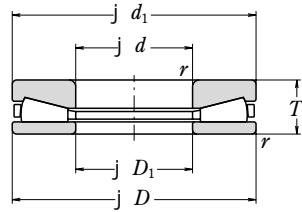

TTF

Boundary Dimensions (mm/inch)				Basic Load Ratings (kN)		Bearing Numbers
d	D	T	r min.	C _a	C _{0a}	
170	320	100	5	1 650	5 550	170TT3201
174.625	358.775	82.550	6.4	1 740	7 400	*174TT3551
6.8750	14.1250	3.2500	6.4	1 740	7 400	*174TT3551
	358.775	82.550	6.4	1 740	7 400	*174TTF3551
	14.1250	3.2500	6.4	1 740	7 400	*174TTF3551
177.800	368.300	82.550	8.0	1 900	8 250	*177TT3651
7.0000	14.5000	3.2500	8.0	1 900	8 250	*177TT3651
203.200	419.100	92.075	9.7	2 530	11 300	*203TT4151
8.0000	16.5000	3.6250	9.7	2 530	11 300	*203TT4151
	419.100	92.075	9.7	2 530	11 300	*203TTF4153A
	16.5000	3.6250	9.7	2 530	11 300	*203TTF4153A
	419.100	120.650	9.7	2 530	11 300	*203TT4152
	16.5000	4.7500	9.7	2 530	11 300	*203TT4152
	419.100	120.650	9.7	2 530	11 300	*203TTF4152
	16.5000	4.7500	9.7	2 530	11 300	*203TTF4152
206.375	419.100	120.370	C10	2 590	11 700	*206TT4151
8.1250	16.5000	4.7390	C10	2 590	11 700	*206TT4151
228.600	482.600	104.775	11.2	3 350	16 400	*228TT4851
9.0000	19.0000	4.1250	11.2	3 350	16 400	*228TT4851
	482.600	104.775	11.2	3 350	16 400	*228TTF4851
	19.0000	4.1250	11.2	3 350	16 400	*228TTF4851
234.950	546.100	127.000	15.9	4 600	21 400	*234TT5451
9.2500	21.5000	5.0000	15.9	4 600	21 400	*234TT5451
241	404	110	4	2 200	8 650	241TTF4002
241.300	496.888	129.000	C8	3 450	16 700	*241TT4952
9.5000	19.5625	5.0787	C8	3 450	16 700	*241TT4952

Dimensions (mm)		Corner Radius of Shaft or Housing	Mass (kg)
D ₁	d ₁	r _a	approx.
170.5	320	4	39.3
174.625	358.775	6.4	43.3
174.625	358.775	6.4	43.3
174.625	358.775	6.4	43.3
174.625	358.775	6.4	43.3
180.400	365.800	8.0	45.9
180.400	365.800	8.0	45.9
205.600	416.700	9.7	66.1
205.600	416.700	9.7	66.1
203.200	419.100	9.7	66.1
203.200	419.100	9.7	66.1
205.600	416.700	9.7	86.6
205.600	416.700	9.7	86.6
205.600	416.700	9.7	86.6
205.600	416.700	9.7	86.6
206.375	419.100	6	85.5
206.375	419.100	6	85.5
228.900	482.600	11.2	101
228.900	482.600	11.2	101
230.600	480.600	11.2	101
230.600	480.600	11.2	101
237.000	544.000	15.9	165
237.000	544.000	15.9	165
241	404	3	61.8
241.300	496.888	5	130
241.300	496.888	5	130

Note * Bearings marked * are inch design.



Thrust Tapered Roller Bearings

TT, TTF Types

Bore Diameter 254.000 – 600 mm

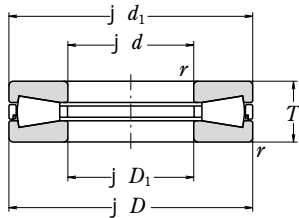

TT

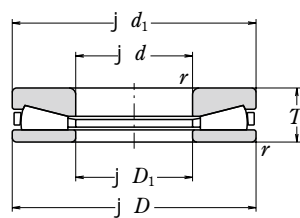

TTF

Boundary Dimensions (mm/inch)				Basic Load Ratings (kN)		Bearing Numbers
d	D	T	r min.	C_a	C_{0a}	
254.000	539.750	117.475	11.2	3 950	18 600	*254TTF5351
10.0000	21.2500	4.6250	11.2	3 950	18 600	*254TTF5351
260	360	75	2.1	1 110	1 110	260TTF3601
273.050	552.450	133.350	C8	4 400	20 700	*273TTF5551
10.7500	21.7500	5.2500	C8	4 400	20 700	*273TTF5551
279.400	603.250	136.525	11.2	5 400	25 200	*279TTF6051
11.0000	23.7500	5.3750	11.2	5 400	25 200	*279TTF6051
330	440	85	3	1 300	6 300	330TTF4401
340	460	96	3	1 690	7 750	340TTF4603
350	460	85	2	1 370	6 600	350TTF4602A(1)
360	470	85	4	1 440	6 950	360TTF4701
360	600	120	4	3 700	20 100	360TTF6201
380	550	110	4	2 760	12 100	380TTF5501
406.400	711.200	146.050	9.7	5 900	28 600	*406TT7151
16.0000	28.0000	5.7500	9.7	5 900	28 600	*406TT7151
	838.200	177.800	12.7	8 950	46 500	*406TT8351
	33.0000	7.0000	12.7	8 950	46 500	*406TT8351
431.800	863.600	228.600	10.4	15 100	69 500	*431TTF8651
17.0000	34.0000	9.0000	10.4	15 100	69 500	*431TTF8651
440	600	105	4	2 720	13 900	440TTF6001
450	570	100	3	2 170	10 500	450TTF5701
460	580	90	3	1 890	9 550	460TTF5801
500	630	82	3	2 020	11 600	500TTF6301
508	730.25	120.65	6	4 900	26 100	508TT7301
508.000	990.600	196.850	12.7	12 000	65 000	*508TT9951
20.0000	39.0000	7.7500	12.7	12 000	65 000	*508TT9951
558	780	120	9.5	4 800	25 500	558TT7801
558.800	1 066.800	285.750	10.4	21 100	94 500	*558TTF1051
22.0000	42.0000	11.2500	10.4	21 100	94 500	*558TTF1051
560	670	85	3	1 950	10 700	560TTF6701
600	710	86	3	1 900	10 700	600TTF7101

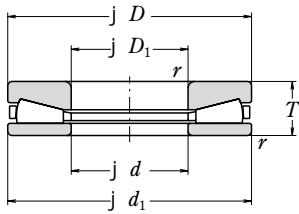

TTF-1

Dimensions (mm)		Corner Radius of Shaft or Housing	Mass (kg)
D_1	d_1	r_a	approx.
254.000	539.750	11.2	142
254.000	539.750	11.2	142
260.3	360	2	24.8
273.050	552.450	5	164
273.050	552.450	5	164
279.700	603.250	11.2	208
279.700	603.250	11.2	208
331	440	2.5	38.5
340	460	2.5	49.2
351	450	2	40.4
360.4	470	3	41.4
366	620	3	148
381	550	3	92.9
406.800	711.200	9.7	266
406.800	711.200	9.7	266
406.800	837.800	12.7	510
406.800	837.800	12.7	510
435.000	862.000	10.4	683
435.000	862.000	10.4	683
440	600	3	93.3
455	569	2.5	65.4
465	579	2.5	60
505	628	2.5	64.3
509	730.25	5	177
508.000	990.600	12.7	760
508.000	990.600	12.7	760
558	780	8	190
561.980	1 065.219	10.4	1 260
561.980	1 065.219	10.4	1 260
565	668	2.5	61.4
604	710	2.5	66.2

Note * Bearings marked * are inch design.

(!) For this bearing, the dimensional symbols are defined by Figure TTF-1.



Thrust Spherical Roller Bearings

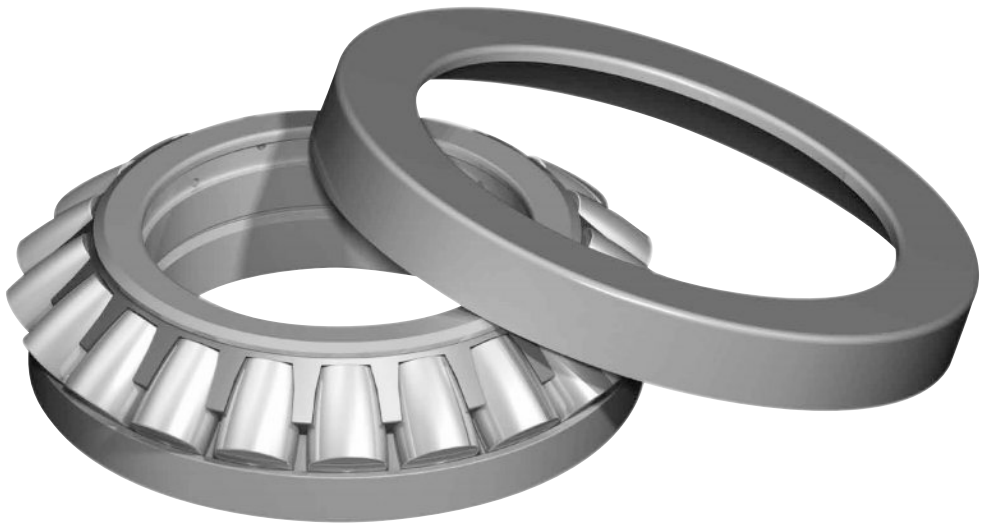

11. THRUST SPHERICAL ROLLER BEARINGS

Introduction.....	Page
	B 350

BEARINGS TABLE

THRUST TAPERED ROLLER BEARINGS

Bore Dia.	Page
60 - 500 mm.....	B 352



Thrust Spherical Roller Bearings

DESIGN, TYPES, AND FEATURES

THRUST SPHERICAL ROLLER BEARINGS

These are thrust bearings containing convex rollers. They have a selfaligning capability and are free of any influence of mounting error or shaft deflection. Besides the original type, the E type with pressed cages for high load capacity is also available. Their bearing numbers are suffixed by E. For horizontal shaft or high speed application, machined brass cages are recommended. For details, contact NSK. Since there are several places where lubrication is difficult, such as the area between the roller heads and inner ring rib, the sliding surfaces between cage and guide sleeve, etc., oil lubrication should be used even at low speed. The cages in the original type are machined brass.

TOLERANCES AND RUNNING ACCURACY

Thrust Spherical Roller Bearings..... Table 7.8 (Page A145)

RECOMMENDED FITS

Thrust Spherical Roller Bearings..... Table 8.4 (Page A164)
..... Table 8.6 (Page A165)

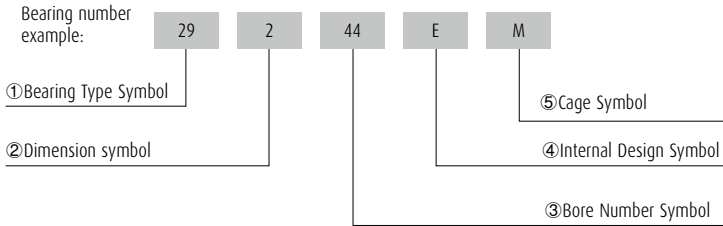

Dimensions related to Mounting

The dimensions related to mounting of thrust spherical roller bearings are listed in the Bearing Table. If the bearing load is heavy, it is necessary to design the shaft shoulder with ample strength in order to provide sufficient support for the shaft washer.

Permissible Misalignment

The permissible misalignment of thrust spherical roller bearings varies depending on the size, but it is approximately 0.018 to 0.036 radian (1° to 2°) with average loads.

Minimum axial load

It is necessary to apply some axial load to thrust bearings to prevent slippage between the rolling elements and raceways. For more details, please refer to Page A198.



Thrust Spherical Roller Bearings

Bore Diameter 60 – 200 mm

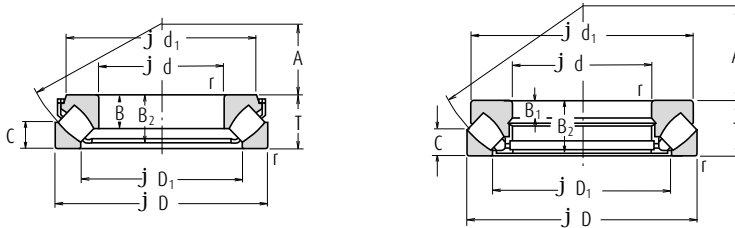

Boundary Dimensions (mm)				Basic Load Ratings (N)		Limiting Speeds (min ⁻¹)	Bearing Numbers
d	D	T	r min.	C _a	C _{0a}	Oil	
60	130	42	1.5	330 000	885 000	2 600	29412 E
65	140	45	2	405 000	1 100 000	2 400	29413 E
70	150	48	2	450 000	1 240 000	2 400	29414 E
75	160	51	2	515 000	1 430 000	2 200	29415 E
80	170	54	2.1	575 000	1 600 000	2 000	29416 E
85	150	39	1.5	330 000	1 040 000	2 400	29317 E
	180	58	2.1	630 000	1 760 000	1 900	29417 E
90	155	39	1.5	350 000	1 080 000	2 200	29318 E
	190	60	2.1	695 000	1 950 000	1 800	29418 E
100	170	42	1.5	410 000	1 280 000	2 000	29320 E
	210	67	3	840 000	2 400 000	1 600	29420 E
110	190	48	2	530 000	1 710 000	1 800	29322 E
	230	73	3	1 010 000	2 930 000	1 500	29422 E
120	210	54	2.1	645 000	2 100 000	1 600	29324 E
	250	78	4	1 160 000	3 400 000	1 400	29424 E
130	225	58	2.1	740 000	2 450 000	1 500	29326 E
	270	85	4	1 330 000	3 900 000	1 200	29426 E
140	240	60	2.1	840 000	2 810 000	1 400	29328 E
	280	85	4	1 370 000	4 200 000	1 200	29428 E
150	250	60	2.1	870 000	2 900 000	1 400	29330 E
	300	90	4	1 580 000	4 900 000	1 100	29430 E
160	270	67	3	1 010 000	3 400 000	1 300	29332 E
	320	95	5	1 740 000	5 400 000	1 100	29432 E
170	280	67	3	1 050 000	3 500 000	1 200	29334 E
	340	103	5	1 680 000	5 800 000	1 000	29434
180	300	73	3	1 230 000	4 200 000	1 100	29336 E
	360	109	5	1 870 000	6 500 000	900	29436
190	320	78	4	1 370 000	4 700 000	1 100	29338 E
	380	115	5	2 100 000	7 450 000	850	29438
200	280	48	2	540 000	2 310 000	1 500	29240
	340	85	4	1 570 000	5 450 000	1 000	29340 E
	400	122	5	2 290 000	8 150 000	800	29440

Note (1) For heavy load applications, a d_0 value should be chosen which is large enough to support the shaft washer rib.

Dynamic Equivalent Load

$$P = 1.2 F_r + F_a$$

Static Equivalent Load

$$P_0 = 2.8 F_r + F_a$$

However, $F_r/F_a \leq 0.55$ must be satisfied.

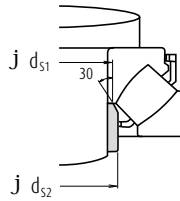
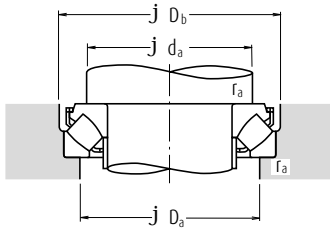

Dimensions (mm)						Spacer Sleeve Dimensions (mm)		Abutment and Fillet Dimensions (mm)			Mass (kg)	
d ₁	D ₁	B, B ₁	B ₂	C	A	d _{s1} max.	d _{s2} max.	d _a (l) min.	D _a max.	D _b min.	r _a max.	approx.
114.5	89	27	38	20	38	67	67	90	108	133	1.5	2.55
121.5	93	29.5	40.5	22	42	72	72	100	115	143	2	3.2
131.5	102	31	43	24	44	78	78	105	125	153	2	3.9
138	107	33.5	46	25	47	83	83	115	132	163	2	4.65
148	114.5	35	48.5	27	50	89	89	120	140	173	2	5.55
134.5	112	24.5	35.5	19	50	91	91	115	135	153	1.5	2.7
156.5	124	37	51.5	28	54	95	95	130	150	183	2	6.55
139.5	118	24.5	35	19	52	97	97	120	140	158	1.5	2.83
165.5	129.5	39	54.5	29	56	100	100	135	157	193	2	7.55
152	128	26.2	38	20.8	58	107	107	130	150	173	1.5	3.6
185	144	43	59.5	33	62	111	111	150	175	214	2.5	10.3
169.5	142.5	30.3	43.5	24	64	117	117	145	165	193	2	5.25
200	157	47	64.5	36	69	121	129	165	190	234	2.5	13.3
187.5	156.5	34	48.5	27	70	130	130	160	180	214	2	7.3
215	171	50.5	69.5	38	74	132	142	180	205	254	3	16.6
203.5	168.5	37	53.5	28	76	141	143	170	195	229	2	8.95
235	185	54	74.5	42	81	143	153	195	225	275	3	21.1
216.5	179	38.5	54	30	82	148	154	185	205	244	2	10.4
244.5	195.5	54	74.5	42	86	153	162	205	235	285	3	22.2
224	190	38	54.5	29	87	158	163	195	215	254	2	10.8
266	209	58	81	44	92	164	175	220	250	306	3	27.3
243	203	42	60	33	92	169	176	210	235	275	2.5	14.3
278	224.5	60.5	84.5	46	99	175	189	230	265	326	4	32.1
252	214.5	42.2	60.5	32	96	178	188	220	245	285	2.5	14.8
310	243	37	99	50	104	—	—	245	285	—	4	43.5
270	227	46	65.5	36	103	189	195	235	260	306	2.5	19
330	255	39	105	52	110	—	—	260	300	—	4	52
288.5	244	49	69	38	110	200	211	250	275	326	3	23
345	271	41	111	55	117	—	—	275	320	—	4	60
266	236	15	46	24	108	—	—	235	255	—	2	8.55
306.5	257	53.5	75	41	116	211	224	265	295	346	3	28.5
365	280	43	117	59	122	—	—	290	335	—	4	69



Thrust Spherical Roller Bearings

Bore Diameter 220 – 420 mm

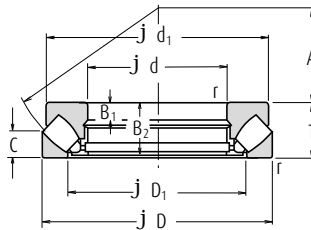

Boundary Dimensions (mm)				Basic Load Ratings (N)		Limiting Speeds (min ⁻¹)	Bearing Numbers
d	D	T	r min.	C _a	C _{0a}	Oil	
220	300	48	2	560 000	2 500 000	1 400	29244
	360	85	4	1 340 000	5 200 000	950	29344
	420	122	6	2 350 000	8 650 000	800	29444
240	340	60	2.1	800 000	3 450 000	1 200	29248
	380	85	4	1 360 000	5 400 000	950	29348
	440	122	6	2 420 000	9 100 000	750	29448
260	360	60	2.1	855 000	3 850 000	1 200	29252
	420	95	5	1 700 000	6 800 000	800	29352
	480	132	6	2 820 000	10 700 000	710	29452
280	380	60	2.1	885 000	4 100 000	1 100	29256
	440	95	5	1 830 000	7 650 000	800	29356
	520	145	6	3 400 000	13 100 000	630	29456
	520	145	6	3 950 000	14 900 000	630	29456 EM
300	420	73	3	1 160 000	5 150 000	950	29260
	480	109	5	2 190 000	9 100 000	710	29360
	540	145	6	3 500 000	13 700 000	630	29460
320	440	73	3	1 190 000	5 450 000	950	29264
	500	109	5	2 230 000	9 400 000	670	29364
	580	155	7.5	3 650 000	14 600 000	560	29464
340	460	73	3	1 230 000	5 750 000	900	29268
	540	122	5	2 640 000	11 200 000	630	29368
	620	170	7.5	4 400 000	17 400 000	530	29468
360	500	85	4	1 550 000	7 300 000	800	29272
	560	122	5	2 670 000	11 500 000	600	29372
	640	170	7.5	4 200 000	17 200 000	500	29472
380	640	170	7.5	5 450 000	20 400 000	500	29472 EM
	520	85	4	1 620 000	7 800 000	800	29276
	600	132	6	3 300 000	14 500 000	560	29376
400	670	175	7.5	4 800 000	19 500 000	480	29476
	540	85	4	1 640 000	8 000 000	750	29280
	620	132	6	3 250 000	14 500 000	530	29380
420	710	185	7.5	5 400 000	22 100 000	450	29480
	580	95	5	2 010 000	9 800 000	670	29284
	650	140	6	3 500 000	15 700 000	500	29384
	730	185	7.5	5 650 000	23 500 000	450	29484

Note (1) For heavy load applications, a d_g value should be chosen which is large enough to support the shaft washer rib.

Dynamic Equivalent Load
 $P = 1.2 F_r + F_a$

Static Equivalent Load
 $P_0 = 2.8 F_r + F_a$
 However, $F_r / F_a \leq 0.55$ must be satisfied.

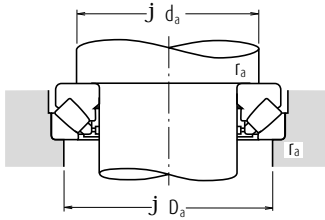

Dimensions (mm)						Abutment and Fillet Dimensions (mm)			Mass (kg)
d_1	D_1	B_1	B_2	C	A	d_a (') min.	D_a max.	r_a max.	approx.
285	254	15	46	24	117	260	275	2	9.2
335	280	29	81	41	125	285	315	3	33
385	308	43	117	58	132	310	355	5	74
325	283	19	57	30	130	285	305	2	16.5
355	300	29	81	41	135	300	330	3	35.5
405	326	43	117	59	142	330	375	5	79
345	302	19	57	30	139	305	325	2	18
390	329	32	91	45	148	330	365	4	48.5
445	357	48	127	64	154	360	405	5	105
365	323	19	57	30	150	325	345	2	19
410	348	32	91	46	158	350	390	4	52.5
480	384	52	140	68	166	390	440	5	132
480	380	52	140	70	166	410	445	5	134
400	353	21	69	38	162	355	380	2.5	30
450	379	37	105	50	168	380	420	4	74
500	402	52	140	70	175	410	460	5	140
420	372	21	69	38	172	375	400	2.5	32.5
470	399	37	105	53	180	400	440	4	77
555	436	55	149	75	191	435	495	6	175
440	395	21	69	37	183	395	420	2.5	33.5
510	428	41	117	59	192	430	470	4	103
590	462	61	164	82	201	465	530	6	218
480	423	25	81	44	194	420	455	3	51
525	448	41	117	59	202	450	495	4	107
610	480	61	164	82	210	485	550	6	228
580	474	61	164	83	210	495	550	6	220
496	441	27	81	42	202	440	475	3	52
568	477	44	127	63	216	480	525	5	140
640	504	63	168	85	230	510	575	6	254
517	460	27	81	42	212	460	490	3	55
590	494	44	127	64	225	500	550	5	150
680	536	67	178	89	236	540	610	6	306
553	489	30	91	46	225	490	525	4	72
620	520	48	135	68	235	525	575	5	170
700	556	67	178	89	244	560	630	6	323

Thrust Spherical Roller Bearings

Bore Diameter 440 – 500 mm

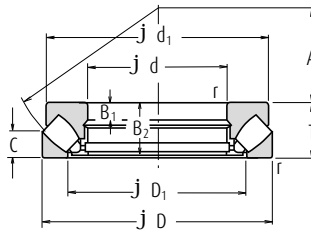

Boundary Dimensions (mm)				Basic Load Ratings (N)		Limiting Speeds (min ⁻¹)	Bearing Numbers
d	D	T	r min.	C _a	C _{0a}	Oil	
440	600	95	5	2 030 000	10 100 000	670	29288
	680	145	6	3 750 000	16 700 000	480	29388
	780	206	9.5	6 550 000	27 200 000	400	29488
460	780	206	9.5	8 000 000	31 500 000	400	29488 EM
	620	95	5	2 060 000	10 300 000	670	29292
480	710	150	6	4 100 000	18 400 000	450	29392
	800	206	9.5	6 750 000	28 600 000	380	29492
	650	103	5	2 370 000	12 100 000	600	29296
500	730	150	6	4 150 000	19 000 000	450	29396
	850	224	9.5	7 200 000	31 000 000	360	29496
	670	103	5	2 390 000	12 400 000	600	292/500
500	750	150	6	4 350 000	20 400 000	450	293/500
	870	224	9.5	7 850 000	33 000 000	340	294/500

Note (1) For heavy load applications, a d_3 value should be chosen which is large enough to support the shaft washer rib.

Dynamic Equivalent Load

$$P = 1.2 F_r + F_a$$

Static Equivalent Load

$$P_0 = 2.8 F_r + F_a$$

However, $F_r/F_a \leq 0.55$ must be satisfied.

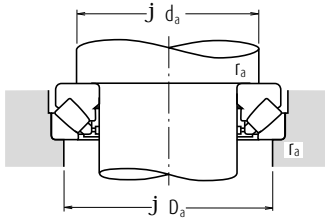

Dimensions (mm)						Abutment and Fillet Dimensions (mm)			Mass (kg)
d_1	D_1	B_1	B_2	C	A	d_a (°) min.	D_a max.	r_a max.	approx.
575	508	30	91	49	235	510	545	4	77
645	548	49	140	70	245	550	600	5	190
745	588	74	199	100	260	595	670	8	407
710	577	74	199	101	257	605	675	8	402
592	530	30	91	46	245	530	570	4	80
666	567	51	144	72	257	575	630	5	210
765	608	74	199	100	272	615	690	8	420
624	556	33	99	55	259	555	595	4	97
690	590	51	144	72	270	595	650	5	215
810	638	81	216	108	280	645	730	8	545
645	574	33	99	55	268	575	615	4	100
715	611	51	144	74	280	615	670	5	220
830	661	81	216	107	290	670	750	8	560



Ball Bearing Units



12. BALL BEARING UNITS

DESIGN AND TYPES

For ball bearing units, there are many designs and types.
Please refer to specified Catalog below, for more detailed information.
Specified Catalog

Ball Bearing Units CAT.No. E1154

Ball Bearing Units Steel Series CAT.No. E1232

Ball Bearing Units with Ductile Cast Iron Housing CAT.No. E1233

Triple-Sealed Bearings for Ball Bearing Units CAT.No. E1234

Ball Bearings Units Stainless Series CAT.No. E1235

Ball Bearing Units Hand book CAT.No. E1155



Plummer Blocks

SNN SERIES AND SD SERIES



Plummer Blocks SNN 500 - 600 Series

Plummer Blocks SD 3100 Serie

20 - 65 mm	B 368
70 - 140 mm	B 370
150 - 380 mm	B 372

Housing Features - Designation

The plummer block housings detailed in this brochure are manufactured in accordance with ISO/R113 standards.

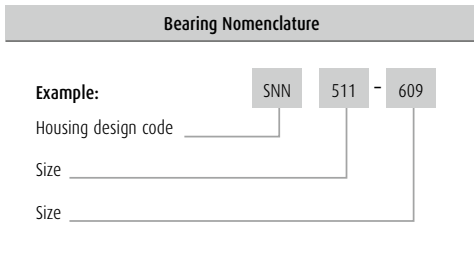

Housings Features

- > Colour: RAL 7001, Pantone 444C
- > Housing Material: Cast Iron Grade 200
- > Cap bolts: Mild steel AISI1010 Grade 8.8
- > Metal plugs: Mild steel AISI 1010
- > Tolerance of bearing seating: H7
- > The bearing seating is protected against corrosion, all the non machined internal parts are primed.
- > Each housing is supplied with a straight grease nipple (see dimensions in the lubrication section).
- > Each SNN housing is supplied with 2 lubrication holes on the cap and 1 drain hole on the base.

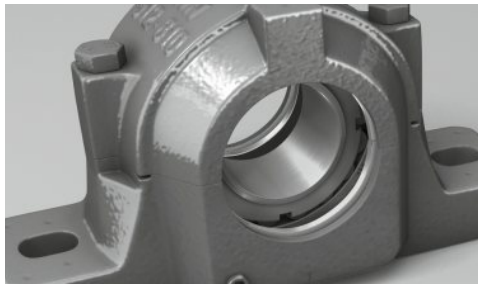

Housings Designation

500 Series

for light series bearings with tapered bore
1200K, 2200K, 22200K, 23200K

600 Series

for medium series bearings with tapered bore
1300K, 2300K, 21300K, 22300K

The SNN 500 and 600 series comprise a number of housings which, when combined with different seal options and ball or spherical roller bearings, provide an answer for most plummer block applications with shaft diameters ranging from 20 mm to 140 mm.

Plummer Blocks

Plummer blocks typical arrangement

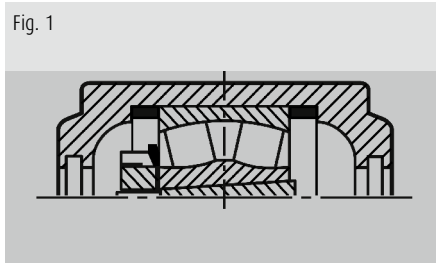

Fig. 1:
In the fixed plummer block, to prevent axial displacement of the bearing, 2 locating rings are installed, one on either side of the bearing.

Locating Rings are manufactured in aluminium.

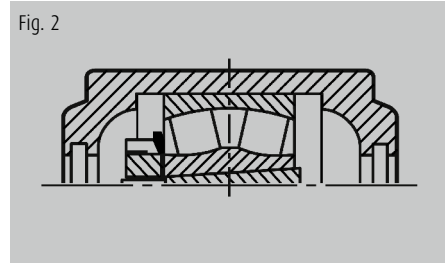

Fig. 2:
One bearing should be free to move axially. This plummer block should not be assembled with locating rings.

How to order SNN complete Plummer Blocks from NSK

Example 1 – Application with 2 plummer blocks

Free end

Through shaft diam 50 mm, equipped with 1 spherical roller bearing 22211EAK, double lip seals on both sides.

Parts required:

- > 1 NSK housing SNN511-609
- > 1 NSK bearing 22211EAKE4
- > 1 NSK adapter sleeve H311
- > 1 seal pack G511-KIT (2 seals included)

Fixed end

Shaft end, diam 50 mm, equipped with 1 spherical roller bearing 22211EAK, double lip seal on 1 side.

Parts required:

- > 1 NSK housing SNN511-609
- > 1 NSK bearing 22211EAKE4
- > 1 NSK adapter sleeve H311
- > 1 locating ring kit SR100/9.5-KIT (2 rings included)
- > 1 seal pack G511-KIT (2 seals included)
- > 1 end cover 511A

Example 2 – Application with 2 plummer blocks

Free end

Through shaft diam 75 mm, equipped with 1 spherical roller bearing 22217EAK, labyrinth seals on both sides.

Parts required:

- > 1 NSK housing SNN517
- > 1 NSK bearing 22217EAKE4
- > 1 NSK adapter sleeve H317
- > 2 seals TS517U (the kit includes 1 labyrinth and o-ring)

Fixed end

Shaft end, diam 75 mm, equipped with 1 spherical roller bearing 22217EAK, labyrinth seal on 1 side.

Parts required:

- > 1 NSK housing SNN517
- > 1 NSK bearing 22217EAKE4
- > 1 NSK adapter sleeve H317
- > 1 locating ring kit SR150/12.5-KIT (2 rings included)
- > 1 seal TS517U (the kit includes 1 labyrinth and o-ring)
- > 1 end cover 517A



Plummer Blocks

Breaking Loads for SNN Housings

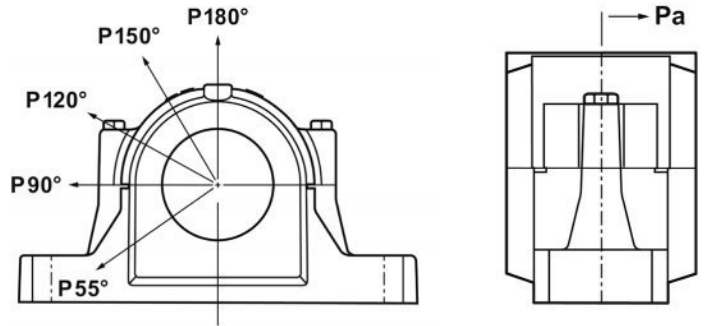

Housing No.	Breaking Load (kN)						Max. Loads of the two cap bolts (kN)
	Pa	P55°	P90°	P120°	P150°	P180°	
SNN 505	52	155	95	70	60	80	25
SNN 506-605	55	170	100	80	65	85	25
SNN 507-606	60	190	115	85	80	95	25
SNN 508-607	70	215	130	95	85	110	25
SNN 509	75	230	140	100	90	115	25
SNN 510-608	85	265	155	120	110	130	25
SNN 511-609	90	275	170	125	115	140	40
SNN 512-610	100	300	180	130	120	150	40
SNN 513-611	110	340	205	150	130	170	40
SNN 515-612	135	410	250	185	160	205	40
SNN 516-613	140	430	260	190	175	215	40
SNN 517	155	480	290	205	190	240	40
SNN 518-615	180	550	340	250	215	275	85
SNN 519-616	190	580	350	260	230	290	85
SNN 520-617	200	620	370	280	250	310	130
SNN 522-619	220	680	410	310	275	340	130
SNN 524-620	260	790	470	350	320	400	130
SNN 526	295	900	540	410	360	450	190
SNN 528	345	1050	630	470	430	530	190
SNN 530	390	1200	730	540	480	600	190
SNN 532	470	1450	860	640	570	720	190

Cap bolt material: Grade 8.8
Reference values only

Cap & Fixing Bolts Sizes – Recommended Tightening Torques

SNN Housing	Cap Bolt Size Grade 8.8	Recommended max. Tightening Torque	Base Bolts Size Grade 8.8	Recommended max. Tightening Torque
		Nm		Nm
SNN505	M10	50	M12	80
SNN506-605	M10	50	M12	80
SNN507-606	M10	50	M12	80
SNN508-607	M10	50	M12	80
SNN509	M10	50	M12	80
SNN510-608	M10	50	M12	80
SNN511-609	M12	80	M16	200
SNN512-610	M12	80	M16	200
SNN513-609	M12	80	M16	200
SNN515-612	M12	80	M16	200
SNN516-613	M16	150	M20	385
SNN517	M16	150	M20	385
SNN518-615	M16	150	M20	385
SNN519-616	M16	150	M20	385
SNN520-617	M20	200	M24	665
SNN522-619	M20	200	M24	665
SNN524-620	M20	200	M24	665
SNN526	M24	350	M24	665
SNN528	M24	350	M30	1310
SNN530	M24	350	M30	1310
SNN532	M24	350	M30	1310



Plummer Blocks SD 3100 Series

BOLT SIZE AND BREAKING LOADS



Plummer blocks of series SD3100 are used with large spherical roller bearings of series 23100 with tapered bore on adapter sleeves.

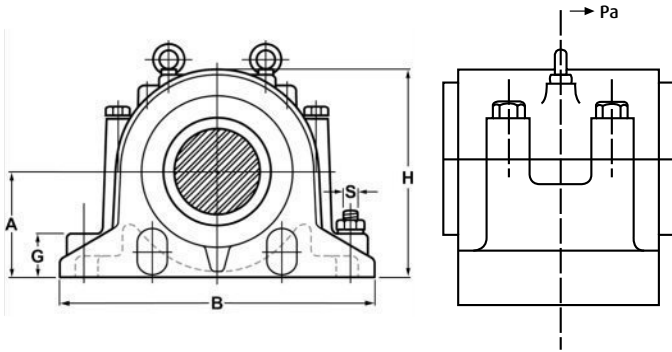

Material: Cast Iron Grade 200

Colour: Dark Blue 533C

Cap bolts grade: 8.8
(size: see table below)

Supplied with 1 straight grease nipple

Tolerance of bearing seating: H7

Draining hole: 1/4PT

SD 3100 Bolt Size

Housing	Bolt Size
SD3134TS/TAC	M20 [°] 2.5P [°] 140LG
SD3136TS/TAC	M24 [°] 3.0P [°] 140LG
SD3138TS/TAC	M24 [°] 3.0P [°] 140LG
SD3140TS/TAC	M24 [°] 3.0P [°] 170LG
SD3144TS/TAC	M24 [°] 3.0P [°] 170LG
SD3148TS/TAC	M30 [°] 3.5P [°] 200LG
SD3152TS/TAC	M30 [°] 3.5P [°] 200LG
SD3156TS/TAC	M30 [°] 3.5P [°] 210LG
SD3160TS/TAC	M30 [°] 3.5P [°] 220LG
SD3164TS/TAC	M30 [°] 3.5P [°] 220LG
SD3168TS/TAC	M36 [°] 4.0P [°] 260LG
SD3172TS/TAC	M36 [°] 4.0P [°] 280LG
SD3176TS/TAC	M36 [°] 4.0P [°] 280LG
SD3180TS/TAC	M36 [°] 4.0P [°] 310LG

Breaking Loads of SD Housings

Housing No.	Breaking Load (kN)					Max. Load of Cap Bolts (kN)
	P55°	P90°	P120°	P150°	P180°	
SD 3134	2273	1016	762	747	846	380
SD 3136	2540	1150	850	835	946	380
SD 3138	2941	1300	1020	966	1095	380
SD 3140	3476	1600	1165	1143	1296	380
SD 3144	4280	1900	1435	1407	1594	380
SD 3148	4548	2000	1524	1495	1694	620
SD 3152	5083	2300	1703	1670	1893	620
SD 3156	5350	2400	1810	1760	1993	620
SD 3160	6420	2900	2215	2110	2390	620
SD 3164	7490	3400	2525	2400	2790	620
SD 3168	9320	4200	3260	3050	3490	800
SD 3172	9750	4400	3370	3200	3690	800
SD 3176	10230	4550	3500	3320	3710	800
SD 3180	10720	4800	3770	3560	4000	800

Reference values only

Note Housings for Tacnite seals (TAC) on request

Plummer Blocks SNN 500 - 600 Series

Shaft Diameter 20 - 65 mm

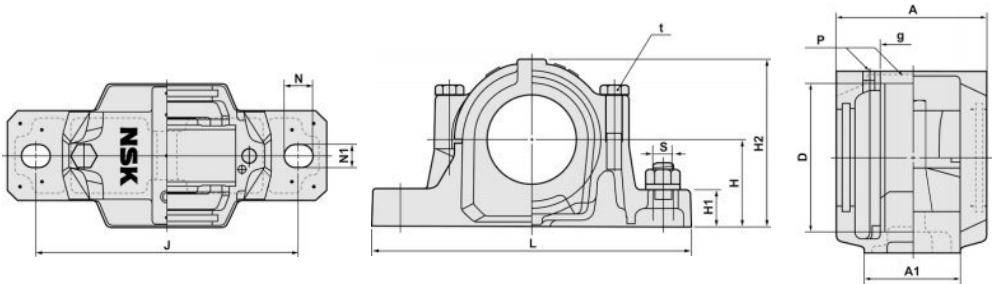

Shaft Diam. D (mm)	Bearing		Adapter Sleeve	Locating Ring Kit (2 rings)	Housing Designation	D (mm)	H (mm)	J (mm)	A (mm)	L (mm)	A1 (mm)	H1 (mm)	H2 (mm)
	Ball	Roller											
20	1205K	-	H205	SR52x5	SNN505	52	40	130	70	165	46	22	73
	2205K	22205K	H305	SR52x3.5	SNN505	52	40	130	70	165	46	22	73
	1305K	21305K	H305	SR62x7.5	SNN506-605	62	50	150	80	185	52	22	88
	2305K	-	H2305	SR62x4	SNN506-605	62	50	150	80	185	52	22	88
25	1206K	-	H206	SR62x8	SNN506-605	62	50	150	80	185	52	22	88
	2206K	22206K	H306	SR62x6	SNN506-605	62	50	150	80	185	52	22	88
	1306K	21306K	H306	SR72x7.5	SNN507-606	72	50	150	85	185	52	22	93
	2306K	-	H2306	SR72x3.5	SNN507-606	72	50	150	85	185	52	22	93
30	1207K	-	H207	SR72x8.5	SNN507-606	72	50	150	85	185	52	22	93
	2207K	22207K	H307	SR72x5.5	SNN507-606	72	50	150	85	185	52	22	93
	1307K	21307K	H307	SR80x9	SNN508-607	80	60	170	90	205	60	25	107
	2307K	-	H2307	SR80x4	SNN508-607	80	60	170	90	205	60	25	107
35	1208K	-	H208	SR80x10.5	SNN508-607	80	60	170	90	205	60	25	107
	2208K	22208K	H308	SR80x8	SNN508-607	80	60	170	90	205	60	25	107
	1308K	21308K	H308	SR90x9	SNN510-608	90	60	170	95	205	60	25	113
	2308K	22308K	H2308	SR90x4	SNN510-608	90	60	170	95	205	60	25	113
40	1209K	-	H209	SR85x5.5	SNN509	85	60	170	90	205	60	25	111
	2209K	22209K	H309	SR85x3.5	SNN509	85	60	170	90	205	60	25	111
	1309K	21309K	H309	SR100x9.5	SNN511-609	100	70	210	100	255	70	28	129
	2309K	22309K	H2309	SR100x4	SNN511-609	100	70	210	100	255	70	28	129
45	1210K	-	H310	SR90x10.5	SNN510-608	90	60	170	95	205	60	25	113
	2210K	22210K	H310	SR90x9	SNN510-608	90	60	170	95	205	60	25	113
	1310K	21310K	H310	SR110x10.5	SNN512-610	110	70	210	110	255	70	30	134
	2310K	22310K	H2310	SR110x4	SNN512-610	110	70	210	110	255	70	30	134
50	1211K	-	H211	SR100x11.5	SNN511-609	100	70	210	100	255	70	28	129
	2211K	22211K	H311	SR100x9.5	SNN511-609	100	70	210	100	255	70	28	129
	1311K	21311K	H311	SR120x11	SNN513-611	120	80	230	115	275	80	30	150
	2311K	22311K	H2311	SR120x4	SNN513-611	120	80	230	115	275	80	30	150
55	1212K	-	H212	SR110x13	SNN512-610	110	70	210	110	255	70	30	134
	2212K	22212K	H312	SR110x10	SNN512-610	110	70	210	110	255	70	30	134
	1312K	21312K	H312	SR130x12.5	SNN515-612	130	80	230	120	280	80	30	155
	2312K	22312K	H2312	SR130x5	SNN515-612	130	80	230	120	280	80	30	155
60	1213K	-	H213	SR120x14	SNN513-611	120	80	230	115	275	80	30	150
	2213K	22213K	H313	SR120x10	SNN513-611	120	80	230	115	275	80	30	150
	1313K	21313K	H313	SR140x12.5	SNN516-613	140	95	260	130	315	90	32	175
	2313K	22313K	H2313	SR140x5	SNN516-613	140	95	260	130	315	90	32	175
65	1215K	-	H215	SR130x15.5	SNN515-612	130	80	230	120	280	80	30	155
	2215K	22215K	H315	SR130x12.5	SNN515-612	130	80	230	120	280	80	30	155
	1315K	21315K	H315	SR160x14	SNN518-615	160	100	290	145	345	100	35	193
	2315K	22315K	H2315	SR160x5	SNN518-615	160	100	290	145	345	100	35	193

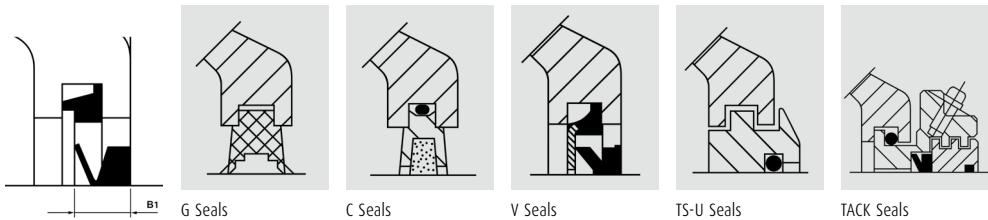

g (mm)	t (mm)	N (mm)	N1 (mm)	s (mm)	P	G Seals KIT	C Seals KIT	V Seals KIT (B1: Fitted Width)	TS-U Seals	TACK Seals	End Cover	Mass (kg)
25	M10	20	15	M12	R1/8	G505-KIT	C505-KIT	V505-KIT (6 ±0.8)	TS505U	TACK505	505A	1.45
25	M10	20	15	M12	R1/8	G505-KIT	C505-KIT	V505-KIT (6 ±0.8)	TS505U	TACK505	505A	1.45
32	M10	20	15	M12	R1/8	G605-KIT	C605-KIT	V605-KIT (6 ±0.8)	TS605U	TACK605	505A	2.00
32	M10	20	15	M12	R1/8	G605-KIT	C605-KIT	V605-KIT (6 ±0.8)	TS605U	TACK605	505A	2.00
32	M10	20	15	M12	R1/8	G506-KIT	C506-KIT	V506-KIT (6 ±0.8)	TS506U	TACK506	506A	2.00
32	M10	20	15	M12	R1/8	G506-KIT	C506-KIT	V506-KIT (6 ±0.8)	TS506U	TACK506	506A	2.00
34	M10	20	15	M12	R1/8	G606-KIT	C606-KIT	V606-KIT (6 ±0.8)	TS606U	TACK606	507A	2.20
34	M10	20	15	M12	R1/8	G606-KIT	C606-KIT	V606-KIT (6 ±0.8)	TS606U	TACK606	507A	2.20
34	M10	20	15	M12	R1/8	G507-KIT	C507-KIT	V507-KIT (6 ±0.8)	TS507U	TACK507	507A	2.20
34	M10	20	15	M12	R1/8	G507-KIT	C507-KIT	V507-KIT (6 ±0.8)	TS507U	TACK507	507A	2.20
39	M10	20	15	M12	R1/8	G607-KIT	C607-KIT	V607-KIT (6 ±0.8)	TS607U	TACK607	508A	2.90
39	M10	20	15	M12	R1/8	G607-KIT	C607-KIT	V607-KIT (6 ±0.8)	TS607U	TACK607	508A	2.90
39	M10	20	15	M12	R1/8	G508-KIT	C508-KIT	V508-KIT (6 ±0.8)	TS508U	TACK508	508A	2.90
39	M10	20	15	M12	R1/8	G508-KIT	C508-KIT	V508-KIT (6 ±0.8)	TS508U	TACK508	508A	2.90
41	M10	20	15	M12	R1/8	G608-KIT	C608-KIT	V608-KIT (6 ±0.8)	TS608U	TACK608	510A	3.10
41	M10	20	15	M12	R1/8	G608-KIT	C608-KIT	V608-KIT (6 ±0.8)	TS608U	TACK608	510A	3.10
30	M10	20	15	M12	R1/8	G509-KIT	C509-KIT	V509-KIT (7 ±1)	TS509U	TACK509	509A	3.00
30	M10	20	15	M12	R1/8	G509-KIT	C509-KIT	V509-KIT (7 ±1)	TS509U	TACK509	509A	3.00
44	M12	24	18	M16	R1/8	G609-KIT	C609-KIT	V609-KIT (7 ±1)	TS609U	TACK609	511A	4.80
44	M12	24	18	M16	R1/8	G609-KIT	C609-KIT	V609-KIT (7 ±1)	TS609U	TACK609	511A	4.80
41	M10	20	15	M12	R1/8	G510-KIT	C510-KIT	V510-KIT (7 ±1)	TS510U	TACK510	510A	3.10
41	M10	20	15	M12	R1/8	G510-KIT	C510-KIT	V510-KIT (7 ±1)	TS510U	TACK510	510A	3.10
48	M12	24	18	M16	R1/8	G610-KIT	C610-KIT	V610-KIT (7 ±1)	TS610U	TACK610	512A	5.40
48	M12	24	18	M16	R1/8	G610-KIT	C610-KIT	V610-KIT (7 ±1)	TS610U	TACK610	512A	5.40
44	M12	24	18	M16	R1/8	G511-KIT	C511-KIT	V511-KIT (7 ±1)	TS511U	TACK511	511A	4.80
44	M12	24	18	M16	R1/8	G511-KIT	C511-KIT	V511-KIT (7 ±1)	TS511U	TACK511	511A	4.80
51	M12	24	18	M16	R1/8	G611-KIT	C611-KIT	V611-KIT (7 ±1)	TS611U	TACK611	513A	6.60
51	M12	24	18	M16	R1/8	G611-KIT	C611-KIT	V611-KIT (7 ±1)	TS611U	TACK611	513A	6.60
48	M12	24	18	M16	R1/8	G512-KIT	C512-KIT	V512-KIT (7 ±1)	TS512U	TACK512	512A	5.40
48	M12	24	18	M16	R1/8	G512-KIT	C512-KIT	V512-KIT (7 ±1)	TS512U	TACK512	512A	5.40
56	M12	24	18	M16	R1/8	G612-KIT	C612-KIT	V612-KIT (7 ±1)	TS612U	TACK612	515A	6.80
56	M12	24	18	M16	R1/8	G612-KIT	C612-KIT	V612-KIT (7 ±1)	TS612U	TACK612	515A	6.80
51	M12	24	18	M16	R1/8	G513-KIT	C513-KIT	V513-KIT (7 ±1)	TS513U	TACK513	513A	6.60
51	M12	24	18	M16	R1/8	G513-KIT	C513-KIT	V513-KIT (7 ±1)	TS513U	TACK513	513A	6.60
58	M16	28	22	M20	R1/4	G613-KIT	C613-KIT	V613-KIT (7 ±1)	TS613U	TACK613	516A	10.20
58	M16	28	22	M20	R1/4	G613-KIT	C613-KIT	V613-KIT (7 ±1)	TS613U	TACK613	516A	10.20
56	M12	24	18	M16	R1/8	G515-KIT	C515-KIT	V515-KIT (7 ±1)	TS515U	TACK515	515A	6.80
56	M12	24	18	M16	R1/8	G515-KIT	C515-KIT	V515-KIT (7 ±1)	TS515U	TACK515	515A	6.80
65	M16	28	22	M20	R1/4	G615-KIT	C615-KIT	V615-KIT (7 ±1)	TS615U	TACK615	518A	13.00
65	M16	28	22	M20	R1/4	G615-KIT	C615-KIT	V615-KIT (7 ±1)	TS615U	TACK615	518A	13.00



Plummer Blocks SNN 500 - 600 Series

Shaft Diameter 70 - 140 mm

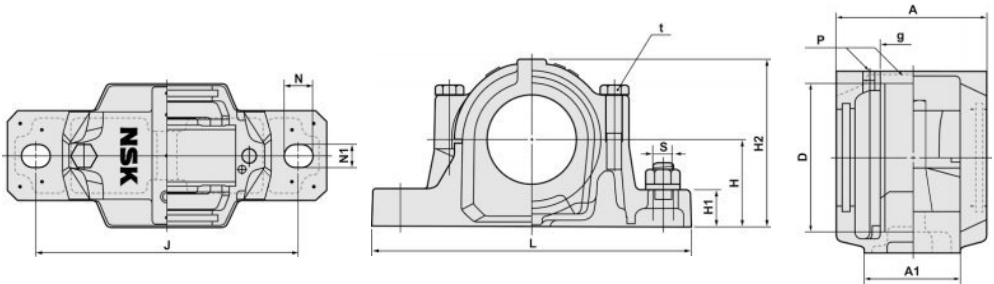

Shaft Diam. D (mm)	Bearing		Adapter Sleeve	Locating Ring Kit (2 rings)	Housing Designation	D (mm)	H (mm)	J (mm)	A (mm)	L (mm)	A1 (mm)	H1 (mm)	H2 (mm)
	Ball	Roller											
70	1216K	-	H216	SR140x16	SNN516-613	140	95	260	130	315	90	32	175
	2216K	22216K	H316	SR140x12.5	SNN516-613	140	95	260	130	315	90	32	175
	1316K	21316K	H316	SR170x14.5	SNN519-616	170	112	290	145	345	100	35	210
	2316K	22316K	H2316	SR170x5	SNN519-616	170	112	290	145	345	100	35	210
75	1217K	-	H217	SR150x16.5	SNN517	150	95	260	135	320	90	32	183
	2217K	22217K	H317	SR150x12.5	SNN517	150	95	260	135	320	90	32	183
	1317K	21317K	H317	SR180x14.5	SNN520-617	180	112	320	160	380	110	40	215
	2317K	22317K	H2317	SR180x5	SNN520-617	180	112	320	160	380	110	40	215
80	1218K	-	H218	SR160x17.5	SNN518-615	160	100	290	145	345	100	35	193
	2218K	22218K	H318	SR160x12.5	SNN518-615	160	100	290	145	345	100	35	193
	-	23218K	H2318	SR160x6.25	SNN518-615	160	100	290	145	345	100	35	193
85	1219K	-	H219	SR170x18	SNN519-616	170	112	290	145	345	100	35	210
	2219K	22219K	H319	SR170x12.5	SNN519-616	170	112	290	145	345	100	35	210
	1319K	21319K	H319	SR200x17.5	SNN522-619	200	125	350	175	410	120	45	240
	2319K	22319K	H2319	SR200x6.5	SNN522-619	200	125	350	175	410	120	45	240
90	1220K	-	H220	SR180x18	SNN520-617	180	112	320	160	380	110	40	215
	2220K	22220K	H320	SR180x12	SNN520-617	180	112	320	160	380	110	40	215
	-	23220K	H2320	SR180x4.75	SNN520-617	180	112	320	160	380	110	40	215
	1320K	21320K	H320	SR215x19.5	SNN524-620	215	140	350	185	410	120	45	271
2320K	22320K	H2320	SR215x6.5	SNN524-620	215	140	350	185	410	120	45	271	
	-	23220K	H2320	SR200x21	SNN522-619	200	125	350	175	410	120	45	240
100	2222K	-	H222	SR200x13.5	SNN522-619	200	125	350	175	410	120	45	240
	-	23222K	H2322	SR200x5	SNN522-619	200	125	350	175	410	120	45	240
110	-	22224K	H3124	SR215x14	SNN524-620	215	140	350	185	410	120	45	271
	-	23224K	H2324	SR215x5	SNN524-620	215	140	350	185	410	120	45	271
	-	22226K	H3126	SR230x13	SNN526	230	150	380	190	445	130	50	288
115	-	23226K	H2326	SR230x5	SNN526	230	150	380	190	445	130	50	288
	-	22228K	H3128	SR250x15	SNN528	250	150	420	205	500	150	50	298
125	-	23228K	H2328	SR250x5	SNN528	250	150	420	205	500	150	50	298
	-	22230K	H3130	SR270x16.5	SNN530	270	160	450	220	530	160	60	322
135	-	23230K	H2330	SR270x5	SNN530	270	160	450	220	530	160	60	322
	-	22232K	H3132	SR290x17	SNN532	290	170	470	235	550	160	60	342
140	-	23232K	H2332	SR290x5	SNN532	290	170	470	235	550	160	60	342
	-	23232K	H2332	SR290x5	SNN532	290	170	470	235	550	160	60	342

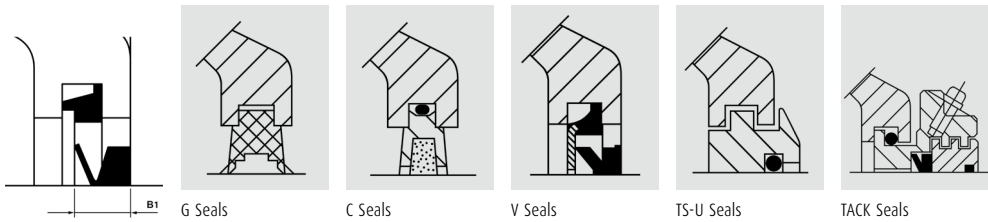

g (mm)	t (mm)	N (mm)	N1 (mm)	s (mm)	P	G Seals KIT	C Seals KIT	V Seals KIT (B1: Fitted Width)	TS-U Seals	TACK Seals	End Cover	Mass (kg)
58	M16	28	22	M20	R1/4	G516-KIT	C516-KIT	V516-KIT (9 ±1.2)	TS516U	TACK516	516A	10.20
58	M16	28	22	M20	R1/4	G516-KIT	C516-KIT	V516-KIT (9 ±1.2)	TS516U	TACK516	516A	10.20
68	M16	28	22	M20	R1/4	G616-KIT	C616-KIT	V616-KIT (9 ±1.2)	TS616U	TACK616	519A	14.50
68	M16	28	22	M20	R1/4	G616-KIT	C616-KIT	V616-KIT (9 ±1.2)	TS616U	TACK616	519A	14.50
61	M16	28	22	M20	R1/4	G517-KIT	C517-KIT	V517-KIT (9 ±1.2)	TS517U	TACK517	517A	11.20
61	M16	28	22	M20	R1/4	G517-KIT	C517-KIT	V517-KIT (9 ±1.2)	TS517U	TACK517	517A	11.20
70	M20	32	26	M24	R1/4	G617-KIT	C617-KIT	V617-KIT (9 ±1.2)	TS617U	TACK617	520A	18.30
70	M20	32	26	M24	R1/4	G617-KIT	C617-KIT	V617-KIT (9 ±1.2)	TS617U	TACK617	520A	18.30
65	M16	28	22	M20	R1/4	G518-KIT	C518-KIT	V518-KIT (9 ±1.2)	TS518U	TACK518	518A	13.00
65	M16	28	22	M20	R1/4	G518-KIT	C518-KIT	V518-KIT (9 ±1.2)	TS518U	TACK518	518A	13.00
65	M16	28	22	M20	R1/4	G518-KIT	C518-KIT	V518-KIT (9 ±1.2)	TS518U	TACK518	518A	13.00
68	M16	28	22	M20	R1/4	G519-KIT	C519-KIT	V519-KIT (9 ±1.2)	TS519U	TACK519	519A	14.50
68	M16	28	22	M20	R1/4	G519-KIT	C519-KIT	V519-KIT (9 ±1.2)	TS519U	TACK519	519A	14.50
80	M20	32	26	M24	R1/4	G619-KIT	C619-KIT	V619-KIT (9 ±1.2)	TS619U	TACK619	522A	24.00
80	M20	32	26	M24	R1/4	G619-KIT	C619-KIT	V619-KIT (9 ±1.2)	TS619U	TACK619	522A	24.00
70	M20	32	26	M24	R1/4	G520-KIT	C520-KIT	V520-KIT (9 ±1.2)	TS520U	TACK520	520A	18.30
70	M20	32	26	M24	R1/4	G520-KIT	C520-KIT	V520-KIT (9 ±1.2)	TS520U	TACK520	520A	18.30
70	M20	32	26	M24	R1/4	G520-KIT	C520-KIT	V520-KIT (9 ±1.2)	TS520U	TACK520	520A	18.30
86	M20	32	26	M24	R3/8	G620-KIT	C620-KIT	V620-KIT (9 ±1.2)	TS620U	TACK620	524A	26.20
86	M20	32	26	M24	R3/8	G620-KIT	C620-KIT	V620-KIT (9 ±1.2)	TS620U	TACK620	524A	26.20
80	M20	32	26	M24	R1/4	G522-KIT	C522-KIT	V522-KIT (9 ±1.2)	TS522U	TACK522	522A	24.00
80	M20	32	26	M24	R1/4	G522-KIT	C522-KIT	V522-KIT (9 ±1.2)	TS522U	TACK522	522A	24.00
80	M20	32	26	M24	R1/4	G522-KIT	C522-KIT	V522-KIT (9 ±1.2)	TS522U	TACK522	522A	24.00
86	M20	32	26	M24	R3/8	G524-KIT	C524-KIT	V524-KIT (9 ±1.2)	TS524U	TACK524	524A	26.20
86	M20	32	26	M24	R3/8	G524-KIT	C524-KIT	V524-KIT (9 ±1.2)	TS524U	TACK524	524A	26.20
90	M24	35	28	M24	R3/8	G526-KIT	C526-KIT	V526-KIT (9 ±1.2)	TS526U	TACK526	526A	33.00
90	M24	35	28	M24	R3/8	G526-KIT	C526-KIT	V526-KIT (9 ±1.2)	TS526U	TACK526	526A	33.00
98	M24	42	35	M30	R3/8	G528-KIT	C528-KIT	V528-KIT (9 ±1.2)	TS528U	TACK528	528A	40.00
98	M24	42	35	M30	R3/8	G528-KIT	C528-KIT	V528-KIT (9 ±1.2)	TS528U	TACK528	528A	40.00
106	M24	42	35	M30	R3/8	G530-KIT	C530-KIT	V530-KIT (9 ±1.2)	TS530U	TACK530	530A	49.00
106	M24	42	35	M30	R3/8	G530-KIT	C530-KIT	V530-KIT (9 ±1.2)	TS530U	TACK530	530A	49.00
114	M24	42	35	M30	R3/8	G532-KIT	C532-KIT	V532-KIT (9 ±1.2)	TS532U	TACK532	532A	55.00
114	M24	42	35	M30	R3/8	G532-KIT	C532-KIT	V532-KIT (9 ±1.2)	TS532U	TACK532	532A	55.00



Plummer Blocks SD 3100 Series

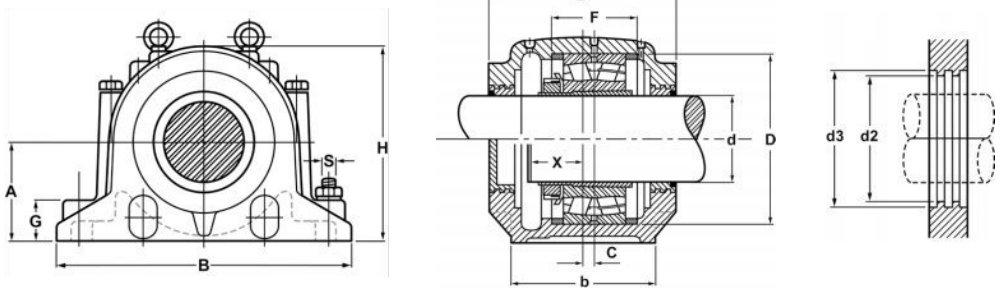

Housing	Shaft Diameter (d)		Dimensions mm																		
			d2		d3																
			D	(H12)	(H12)	A	B	F	E	b	G	H	L	C	E1	X	T	Z	U	V	
Metric	Inch																				
SD3134	150	6	280	187	197	170	510	108	430	180	70	335	230	14	100	76	154	120	28	35	
SD3136	160	6.1/2	300	195	205	180	530	116	450	190	75	355	240	15	110	81	159	130	30	38	
SD3138	170	6.3/4	320	217	230	190	560	124	480	210	80	375	260	10	120	86	168	140	35	48	
SD3140	180	7	340	222	237	210	610	132	510	230	85	410	280	10	130	91	178	150	35	42	
SD3144	200	8	370	246	265	220	640	140	540	240	90	435	290	12	140	96	184	155	36	46	
SD3148	220	9	400	265	285	240	700	148	600	260	95	475	310	12	150	102	194	160	38	46	
SD3152	240	9.1/2	440	285	305	260	770	164	650	280	100	515	320	13	160	112	200	170	45	60	
SD3156	260	10	460	307	327	280	790	166	670	280	105	550	330	16	160	115	200	170	45	60	
SD3160	280	11	500	325	345	300	830	180	710	310	110	590	350	22	190	124	213	190	45	64	
SD3164	300	-	540	345	365	320	880	196	750	330	115	630	370	23	200	135	224	200	45	72	
SD3168	320	-	580	368	390	340	965	210	840	380	120	670	390	25	240	155	244	220	52	70	
SD3172	340	-	600	388	408	360	1040	212	890	390	130	720	400	22	255	159	249	225	60	77	
SD3176	360	-	620	408	428	380	1120	214	980	400	135	750	405	22	255	162	260	240	68	88	
SD3180	380	-	650	428	448	400	1245	220	1050	420	140	790	425	22	270	167	276	260	75	96	

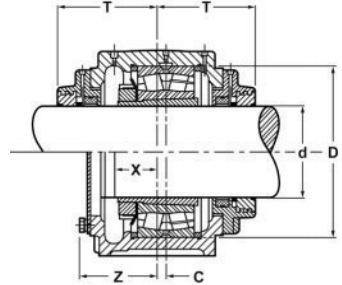
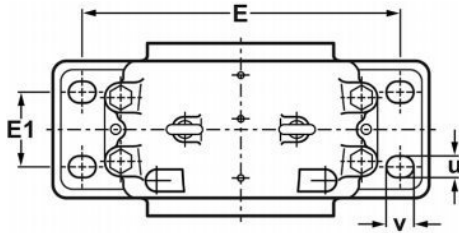

Bolt Diameter	Spherical Roller Bearing	Adapter Sleeve		Weight	Locating Ring	Housing	Labyrinth Seal	End Cover
		Metric	Inch					
s				kg	Dim.			
M24	23134K	H3134	HE3134	66	280x10	SD3134	TS34	TSA34
M24	23136K	H3136	HE3136	75	300x10	SD3136	TS36	TSA36
M24	23138K	H3138	HE3138	87	320x10	SD3138	TS38	TSA38
M30	23140K	H3140	HE3140	113	340x10	SD3140	TS40	TSA40
M30	23144K	H3144	-	129	370x10	SD3144	TS44	TSA44
M30	23148K	H3148	-	163	400x10	SD3148	TS48	TSA48
M36	23152K	H3152	-	199	440x10	SD3152	TS52	TSA52
M36	23156K	H3156	-	226	460x10	SD3156	TS56	TSA56
M36	23160K	H3160	-	283	500x10	SD3160	TS60	TSA60
M36	23164K	H3164	-	346	540x10	SD3164	TS64	TSA64
M36	23168K	H3168	-	514	580x10	SD3168	TS68	TSA68
M48	23172K	H3172	-	594	600x10	SD3172	TS72	TSA72
M56	23176K	H3176	-	702	620x10	SD3176	TS76	TSA76
M64	23180K	H3180	-	740	650x10	SD3180	TS80	TSA80





13. ACCESSORIES FOR ROLLING BEARINGS

ADAPTERS FOR ROLLING BEARINGS

Shaft Dia.	Page
17 - 470 mm	B 376

WITHDRAWAL SLEEVES FOR ROLLING BEARINGS

Shaft Dia.	Page
35 - 480 mm	B 384

Nuts for Rolling Bearings.....	B 390
Stoppers for Nuts	B 395
Lock-Washers for Rolling Bearings	B 396



Adapters for Rolling Bearings

Shaft Diameter 17 – 40 mm

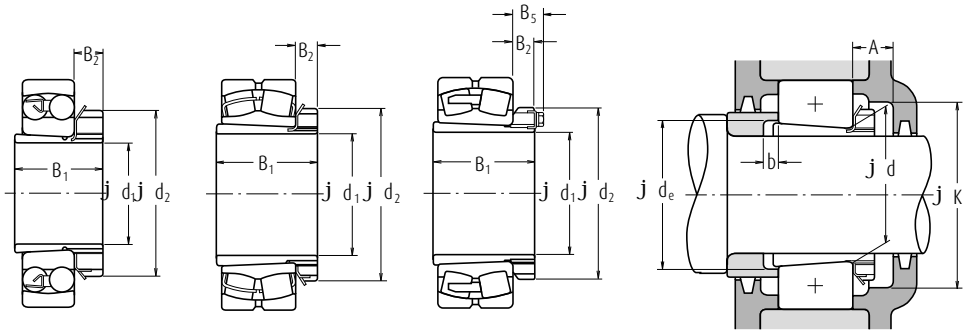

Shaft Diameter (mm)	Nominal Bearing Bore Dia. (mm)	Nominal Numbers Applicable Bearings	Dimensions (mm)				Adapter Sleeve Numbers	Abutment Dimensions (mm)				Mass (kg) approx.
			B ₁	d ₂	B ₂	B ₅		A min.	K min.	d _e min.	b min.	
17	20	1204K + H204X	24	32	7	—	A204X	14	39	23	5	0.045
	20	2204K + H304X	28	32	7	—	A304X	14	39	24	5	0.045
	20	1304K + H304X	28	32	7	—	A304X	14	39	24	8	0.045
	20	2304K + H2304X	31	32	7	—	A2304X	14	39	24	5	0.050
20	25	1205K + H205X	26	38	8	—	A205X	15	45	28	5	0.065
	25	2205K + H305X	29	38	8	—	A305X	15	45	29	5	0.075
	25	1305K + H305X	29	38	8	—	A305X	15	45	29	6	0.075
	25	21305C DKE4 + H305X	29	38	8	—	A305X	15	45	29	6	0.075
25	25	2305K + H2305X	35	38	8	—	A2305X	15	45	29	5	0.090
	30	1206K + H206X	27	45	8	—	A206X	15	50	33	5	0.10
	30	2206K + H306X	31	45	8	—	A306X	15	50	34	5	0.11
	30	1306K + H306X	31	45	8	—	A306X	15	50	34	6	0.11
30	30	21306C DKE4 + H306X	31	45	8	—	A306X	15	50	34	6	0.11
	30	2306K + H2306X	38	45	8	—	A2306X	15	50	35	5	0.125
	35	1207K + H207X	29	52	9	—	A207X	17	58	38	5	0.125
	35	2207K + H307X	35	52	9	—	A307X	17	58	39	5	0.145
35	35	1307K + H307X	35	52	9	—	A307X	17	58	39	7	0.145
	35	21307C DKE4 + H307X	35	52	9	—	A307X	17	58	39	7	0.145
	35	2307K + H2307X	43	52	9	—	A2307X	17	58	40	5	0.16
	40	1208K + H208X	31	58	10	—	A208X	17	65	44	5	0.175
40	40	2208K + H308X	36	58	10	—	A308X	17	65	44	5	0.19
	40	1308K + H308X	36	58	10	—	A308X	17	65	44	5	0.19
	40	21308E AKE4 + H308X	36	58	10	—	A308X	17	65	44	5	0.19
	40	2308K + H2308X	46	58	10	—	A2308X	17	65	45	5	0.225
40	40	22308E AKE4 + H2308X	46	58	10	—	A2308X	17	65	45	5	0.225
	45	1209K + H209X	33	65	11	—	A209X	17	72	49	5	0.225
	45	2209K + H309X	39	65	11	—	A309X	17	72	49	8	0.26
	45	1309K + H309X	39	65	11	—	A309X	17	72	49	5	0.26
45	45	21309E AKE4 + H309X	39	65	11	—	A309X	17	72	49	5	0.26
	45	2309K + H2309X	50	65	11	—	A2309X	17	72	50	5	0.30
	45	22309E AKE4 + H2309X	50	65	11	—	A2309X	17	72	50	5	0.30

Remark The suffix X represents adapter sleeves having narrow slits, for which washers with straight tabs should be used.

Shaft Diameter 45 – 60 mm

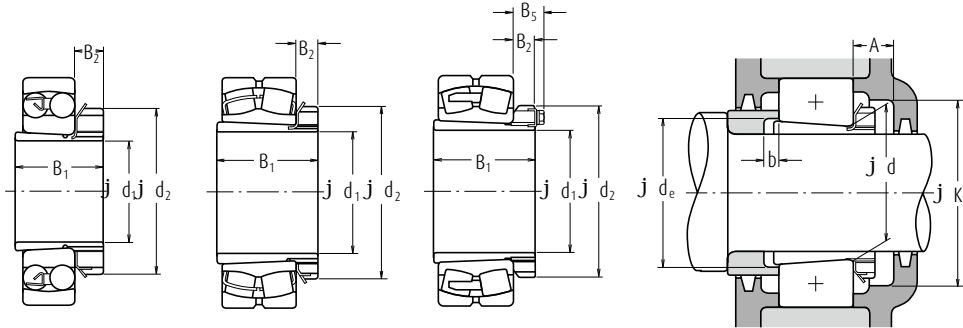

Shaft Diameter (mm)	Nominal Bearing Bore Dia. (mm)	Nominal Numbers	Dimensions (mm)				Adapter Sleeve Numbers	Abutment Dimensions (mm)				Mass (kg)
			Applicable Bearings	B ₁	d ₂	B ₂		B ₃	A min.	K min.	d _e min.	
45	50	1210K + H210X	35	70	12	—	A210X	19	76	53	5	0.275
	50	2210K + H310X	42	70	12	—	A310X	19	76	54	10	0.30
	50	1310K + H310X	42	70	12	—	A310X	19	76	54	5	0.30
	50	2130E AKE4 + H310X	42	70	12	—	A310X	19	76	54	5	0.30
	50	2310K + H2310X	55	70	12	—	A2310X	19	76	56	5	0.35
	50	22310E AKE4 + H2310X	55	70	12	—	A2310X	19	76	56	5	0.35
50	55	1211K + H211X	37	75	12	—	A211X	19	85	60	6	0.305
	55	2211K + H311X	45	75	12	—	A311X	19	85	60	11	0.35
	55	22211E AKE4 + H311X	45	75	12	—	A311X	19	85	60	11	0.35
	55	1311K + H311X	45	75	12	—	A311X	19	85	60	6	0.35
	55	21311E AKE4 + H311X	45	75	12	—	A311X	19	85	60	6	0.35
	55	2311K + H2311X	59	75	12	—	A2311X	19	85	61	6	0.40
55	55	22311E AKE4 + H2311X	59	75	12	—	A2311X	19	85	61	6	0.40
	60	1212K + H212X	38	80	13	—	A212X	20	90	64	5	0.365
	60	2212K + H312X	47	80	13	—	A312X	20	90	65	9	0.40
	60	22212E AKE4 + H312X	47	80	13	—	A312X	20	90	65	9	0.40
	60	1312K + H312X	47	80	13	—	A312X	20	90	65	5	0.40
	60	21312E AKE4 + H312X	47	80	13	—	A312X	20	90	65	5	0.40
60	60	2312K + H2312X	62	80	13	—	A2312X	20	90	66	5	0.45
	60	22312E AKE4 + H2312X	62	80	13	—	A2312X	20	90	66	5	0.45
	65	1213K + H213X	40	85	14	—	A213X	21	96	70	5	0.40
	65	2213K + H313X	50	85	14	—	A313X	21	96	70	8	0.45
	65	22213E AKE4 + H313X	50	85	14	—	A313X	21	96	70	8	0.45
	65	1313K + H313X	50	85	14	—	A313X	21	96	70	5	0.45
65	65	21313E AKE4 + H313X	50	85	14	—	A313X	21	96	70	5	0.45
	65	2313K + H2313X	65	85	14	—	A2313X	21	96	72	5	0.55
	65	22313E AKE4 + H2313X	65	85	14	—	A2313X	21	96	72	5	0.55
	70	22214E AKE4 + H314X	52	92	14	—	A314X	21	96	70	8	0.65
	70	21314E AKE4 + H314X	52	92	14	—	A314X	21	96	70	5	0.65
	70	22314E AKE4 + H2314X	68	92	14	—	A2314X	21	96	72	5	0.80

Remark The suffix X represents adapter sleeves having narrow slits, for which washers with straight tabs should be used.



Adapters for Rolling Bearings

Shaft Diameter 65 – 80 mm

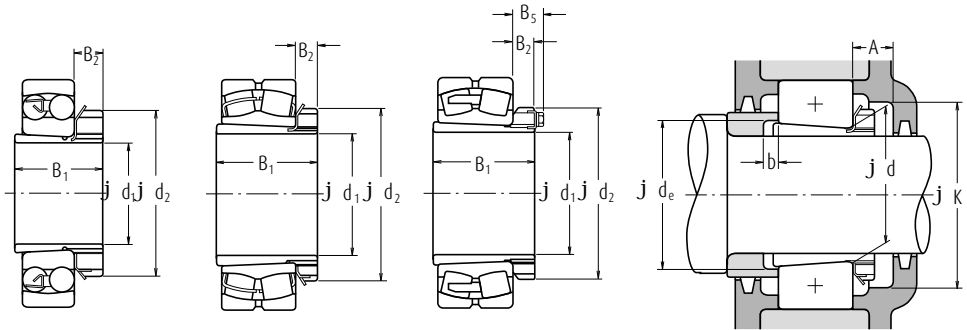

Shaft Diameter (mm)	Nominal Bearing Bore Dia. (mm)	Nominal Numbers Applicable Bearings	Dimensions (mm)				Adapter Sleeve Numbers	Abutment Dimensions (mm)				Mass (kg) approx.
			B ₁	d ₂	B ₂	B ₅		A min.	K min.	d _e min.	b min.	
65	75	1215K + H215X	43	98	15	—	A215X	23	110	80	5	0.70
	75	2215K + H315X	55	98	15	—	A315X	23	110	80	12	0.85
	75	22215E AKE4 + H315X	55	98	15	—	A315X	23	110	80	12	0.85
	75	1315K + H315X	55	98	15	—	A315X	23	110	80	5	0.85
	75	21315E AKE4 + H315X	55	98	15	—	A315X	23	110	80	5	0.85
	75	2315K + H2315X	73	98	15	—	A2315X	23	110	82	5	1.05
70	75	22315E AKE4 + H2315X	73	98	15	—	A2315X	23	110	82	5	1.05
	80	1216K + H216X	46	105	17	—	A216X	25	120	85	5	0.85
	80	2216K + H316X	59	105	17	—	A316X	25	120	86	12	1.05
	80	22216E AKE4 + H316X	59	105	17	—	A316X	25	120	86	12	1.05
	80	1316K + H316X	59	105	17	—	A316X	25	120	86	5	1.05
	80	21316E AKE4 + H316X	59	105	17	—	A316X	25	120	86	5	1.05
75	80	2316K + H2316X	78	105	17	—	A2316X	25	120	87	5	1.3
	80	22316E AKE4 + H2316X	78	105	17	—	A2316X	25	120	87	5	1.3
	85	1217K + H217X	50	110	18	—	A217X	27	128	90	6	1.0
	85	2217K + H317X	63	110	18	—	A317X	27	128	91	12	1.2
	85	22217E AKE4 + H317X	63	110	18	—	A317X	27	128	91	12	1.2
	85	1317K + H317X	63	110	18	—	A317X	27	128	91	6	1.2
80	85	21317E AKE4 + H317X	63	110	18	—	A317X	27	128	91	6	1.2
	85	2317K + H2317X	82	110	18	—	A2317X	27	128	94	6	1.45
	85	22317E AKE4 + H2317X	82	110	18	—	A2317X	27	128	94	6	1.45
	90	1218K + H218X	52	120	18	—	A218X	28	139	95	6	1.15
	90	2218K + H318X	65	120	18	—	A318X	28	139	96	10	1.4
	90	22218E AKE4 + H318X	65	120	18	—	A318X	28	139	96	10	1.4
80	90	1318K + H318X	65	120	18	—	A318X	28	139	96	6	1.4
	90	21318E AKE4 + H318X	65	120	18	—	A318X	28	139	96	6	1.4
	90	2318K + H2318X	86	120	18	—	A2318X	28	139	99	6	1.7
	90	23218C KE4 + H2318X	86	120	18	—	A2318X	28	139	99	6	1.7
	90	22318E AKE4 + H2318X	86	120	18	—	A2318X	28	139	99	6	1.7

Remark The suffix X represents adapter sleeves having narrow slits, for which washers with straight tabs should be used.

Shaft Diameter 85 – 115 mm

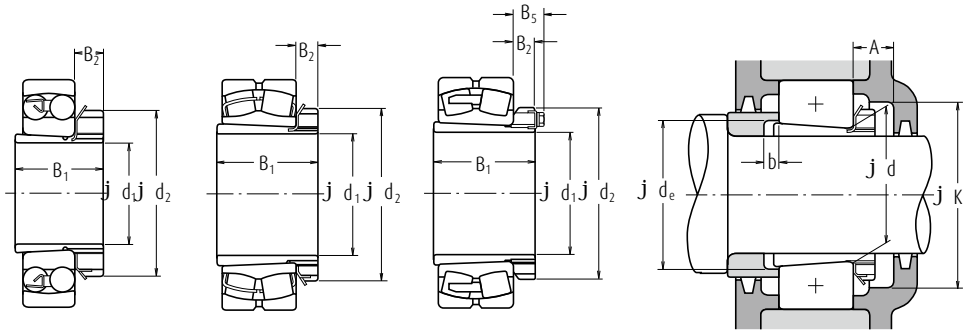

Shaft Diameter (mm) d_1	Nominal Bearing Bore Dia. (mm) d	Nominal Numbers Applicable Bearings	Dimensions (mm)				Adapter Sleeve Numbers	Abutment Dimensions (mm)				Mass (kg) approx.
			B_1	d_2	B_2	B_3		A min.	K min.	d_e min.	b min.	
85	95	1219K + H219X	55	125	19	—	A219X	29	145	101	7	1.35
	95	2219K + H319X	68	125	19	—	A319X	29	145	102	9	1.55
	95	22219E AKE4 + H319X	68	125	19	—	A319X	29	145	102	9	1.55
	95	1319K + H319X	68	125	19	—	A319X	29	145	102	7	1.55
	95	21319C KE4 + H319X	68	125	19	—	A319X	29	145	102	7	1.55
	95	2319K + H2319X	90	125	19	—	A2319X	29	145	105	7	1.9
90	95	22319E AKE4 + H2319X	90	125	19	—	A2319X	29	145	105	7	1.9
	100	1220K + H220X	58	130	20	—	A220X	30	150	106	7	1.45
	100	2220K + H320X	71	130	20	—	A320X	30	150	107	8	1.7
	100	22220E AKE4 + H320X	71	130	20	—	A320X	30	150	107	8	1.7
	100	1320K + H320X	71	130	20	—	A320X	30	150	107	7	1.7
	100	21320C KE4 + H320X	71	130	20	—	A320X	30	150	107	7	1.7
100	100	2320K + H2320X	97	130	20	—	A2320X	30	150	110	7	2.15
	100	23220C KE4 + H2320X	97	130	20	—	A2320X	30	150	110	7	2.15
	100	22320E AKE4 + H2320X	97	130	20	—	A2320X	30	150	110	7	2.15
	110	23122C KE4 + H3122X	81	145	21	—	A3122X	32	170	117	7	2.25
	110	1222K + H222X	63	145	21	—	A222X	32	170	116	7	1.95
	110	2222K + H322X	77	145	21	—	A322X	32	170	117	6	2.3
110	110	22222E AKE4 + H322X	77	145	21	—	A322X	32	170	117	6	2.3
	110	1322K + H322X	77	145	21	—	A322X	32	170	117	9	2.3
	110	2322K + H2322X	105	145	21	—	A2322X	32	170	121	7	2.75
	110	23222C KE4 + H2322X	105	145	21	—	A2322X	32	170	121	17	2.75
	110	22322E AKE4 + H2322X	105	145	21	—	A2322X	32	170	121	7	2.75
	110	23024C DKE4 + H3024	72	145	22	—	A3024	33	180	127	7	1.95
110	120	23124C KE4 + H3124	88	155	22	—	A3124	33	180	128	7	2.65
	120	22224E AKE4 + H3124	88	155	22	—	A3124	33	180	128	11	2.65
	120	23224C KE4 + H2324	112	155	22	—	A2324	33	180	131	17	3.2
	120	22324E AKE4 + H2324	112	155	22	—	A2324	33	180	131	7	3.2
115	130	23026C DKE4 + H3026	80	155	23	—	A3026	34	190	137	8	2.85
	130	23126C KE4 + H3126	92	165	23	—	A3126	34	190	138	8	3.65
	130	22226E AKE4 + H3126	92	165	23	—	A3126	34	190	138	8	3.65
	130	23226C KE4 + H2326	121	165	23	—	A2326	34	190	142	21	4.6
		22326C KE4 + H2326	121	165	23	—	A2326	34	190	142	8	4.6

Remark

The suffix X represents adapter sleeves having narrow slits, for which washers with straight tabs should be used.



Adapters for Rolling Bearings

Shaft Diameter 125 – 170 mm

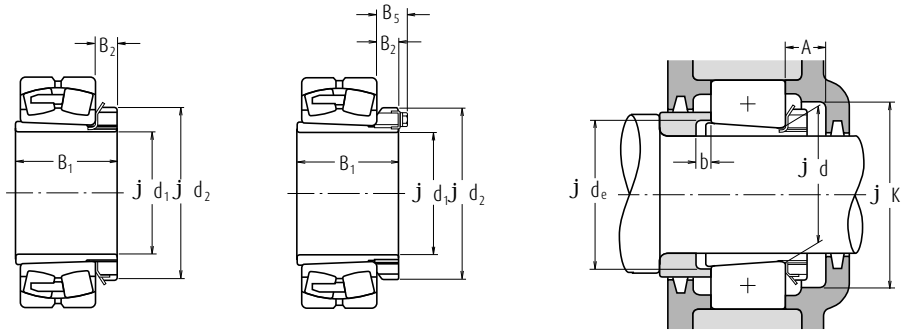

Shaft Diameter (mm)	Nominal Bearing Bore Dia. (mm)	Nominal Numbers	Dimensions (mm)				Adapter Sleeve Numbers	Abutment Dimensions (mm)				Mass (kg)
			Applicable Bearings	B_1	d_2	B_2		B_5	A min.	K min.	d_e min.	
125	140	23028C DKE4 + H3028	82	165	24	—	A3028	36	205	147	8	3.15
	140	23128C KE4 + H3128	97	180	24	—	A3128	36	205	149	8	4.35
	140	22228C DKE4 + H3128	97	180	24	—	A3128	36	205	149	8	4.35
	140	23228C KE4 + H2328	131	180	24	—	A2328	36	205	152	22	5.55
135	140	22328C KE4 + H2328	131	180	24	—	A2328	36	205	152	8	5.55
	150	23030C DKE4 + H3030	87	180	26	—	A3030	37	220	158	8	3.9
	150	23130C KE4 + H3130	111	195	26	—	A3130	37	220	160	8	5.5
	150	22230C DKE4 + H3130	111	195	26	—	A3130	37	220	160	15	5.5
140	150	23230C KE4 + H2330	139	195	26	—	A2330	37	220	163	20	6.6
	150	22330C AKE4 + H2330	139	195	26	—	A2330	37	220	163	8	6.6
	160	23932C AKE4 + H3932	78	190	28	—	A3932	39	205	168	8	4.64
	160	23032C DKE4 + H3032	93	190	28	—	A3032	39	230	168	8	5.2
140	160	23132C KE4 + H3132	119	210	28	—	A3132	39	230	170	8	7.65
	160	22232C DKE4 + H3132	119	210	28	—	A3132	39	230	170	14	7.65
	160	23232C KE4 + H2332	147	210	28	—	A2332	39	230	174	18	9.15
	160	22332C AKE4 + H2332	147	210	28	—	A2332	39	230	174	8	9.15
150	170	23934B CAKE4 + H3934	79	200	29	—	A3934	40	215	179	8	5.07
	170	23034C DKE4 + H3034	101	200	29	—	A3034	40	250	179	8	6.0
	170	23134C KE4 + H3134	122	220	29	—	A3134	40	250	180	8	8.4
	170	22234C DKE4 + H3134	122	220	29	—	A3134	40	250	180	10	8.4
150	170	23234C KE4 + H2334	154	220	29	—	A2334	40	250	185	18	10
	170	22334C AKE4 + H2334	154	220	29	—	A2334	40	250	185	8	10
	180	23936C AKE4 + H3936	87	210	30	—	A3936	41	230	189	8	5.87
	180	23036C DKE4 + H3036	109	210	30	—	A3036	41	260	189	8	6.85
150	180	23136C KE4 + H3136	131	230	30	—	A3136	41	260	191	8	9.5
	180	22236C DKE4 + H3136	131	230	30	—	A3136	41	260	191	18	9.5
	180	23236C KE4 + H2336	161	230	30	—	A2336	41	260	195	22	11.5
	180	22336C AKE4 + H2336	161	230	30	—	A2336	41	260	195	8	11.5
170	190	23938C AKE4 + H3938	89	220	31	—	A3938	43	240	199	9	6.35
	190	23038C AKE4 + H3038	112	220	31	—	A3038	43	270	199	9	7.45
	190	23138C KE4 + H3138	141	240	31	—	A3138	43	270	202	9	11
	190	22238C AKE4 + H3138	141	240	31	—	A3138	43	270	202	21	11
170	190	23238C KE4 + H2338	169	240	31	—	A2338	43	270	206	21	12.5
	190	22338C AKE4 + H2338	169	240	31	—	A2338	43	270	206	9	12.5

Shaft Diameter 180 - 260 mm

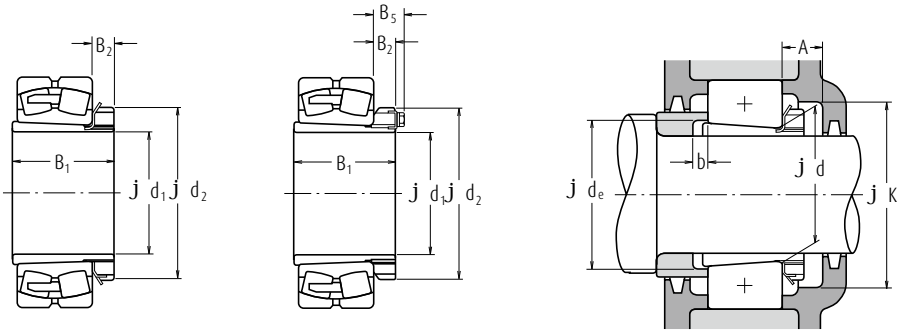

Shaft Diameter (mm)	Nominal Bearing Bore Dia. (mm)	Nominal Numbers	Dimensions (mm)				Adapter Sleeve Numbers	Abutment Dimensions (mm)				Mass (kg)
			B ₁	d ₂	B ₂	B ₅		A min.	K min.	d _e min.	b min.	
180	200	23940C AKE4 + H3940	98	240	32	—	A3940	46	260	210	10	8.0
	200	23040C AKE4 + H3040	120	240	32	—	A3040	46	280	210	10	9.2
	200	23140C KE4 + H3140	150	250	32	—	A3140	46	280	212	10	12
	200	22240C AKE4 + H3140	150	250	32	—	A3140	46	280	212	24	12
	200	23240C KE4 + H2340	176	250	32	—	A2340	46	280	216	20	14
	200	22340C AKE4 + H2340	176	250	32	—	A2340	46	280	216	10	14
200	220	23944C AKE4 + H3944	96	260	30	41	A3944	55	280	231	10	8.32
	220	23044C AKE4 + H3044	128	260	30	41	A3044	55	320	231	12	10.5
	220	23144C KE4 + H3144	158	280	32	44	A3144	55	320	233	10	14.5
	220	22244C AKE4 + H3144	158	280	32	44	A3144	55	320	233	22	14.5
	220	23244C KE4 + H2344	183	280	32	44	A2344	55	320	236	11	16.5
	220	22344C AKE4 + H2344	183	280	32	44	A2344	55	320	236	10	16.5
220	240	23948C AKE4 + H3948	101	290	34	46	A3948	60	300	251	11	11.2
	240	23048C AKE4 + H3048	133	290	34	46	A3048	60	340	251	11	13
	240	23148C KE4 + H3148	169	300	34	46	A3148	60	340	254	11	17.5
	240	22248C AKE4 + H3148	169	300	34	46	A3148	60	340	254	19	17.5
	240	23248C AKE4 + H2348	196	300	34	46	A2348	60	340	257	6	19.5
	240	22348C AKE4 + H2348	196	300	34	46	A2348	60	340	257	11	19.5
240	260	23952C AKE4 + H3952	116	310	34	46	A3952	60	330	272	11	13.4
	260	23052C AKE4 + H3052	147	310	34	46	A3052	60	370	272	13	15.5
	260	23152C AKE4 + H3152	187	330	36	49	A3152	60	370	276	11	22
	260	22252C AKE4 + H3152	187	330	36	49	A3152	60	370	276	25	22
	260	23252C AKE4 + H2352	208	330	36	49	A2352	60	370	278	2	24
	260	22352C AKE4 + H2352	208	330	36	49	A2352	60	370	278	11	24
260	280	23956C AKE4 + H3956	121	330	38	50	A3956	65	350	292	12	15.5
	280	23056C AKE4 + H3056	152	330	38	50	A3056	65	390	292	12	17.5
	280	23156C AKE4 + H3156	192	350	38	51	A3156	65	390	296	12	24.5
	280	22256C AKE4 + H3156	192	350	38	51	A3156	65	390	296	28	24.5
	280	23256C AKE4 + H2356	221	350	38	51	A2356	65	390	299	11	28
	280	22356C AKE4 + H2356	221	350	38	51	A2356	65	390	299	12	28



Adapters for Rolling Bearings

Shaft Diameter 280 – 410 mm

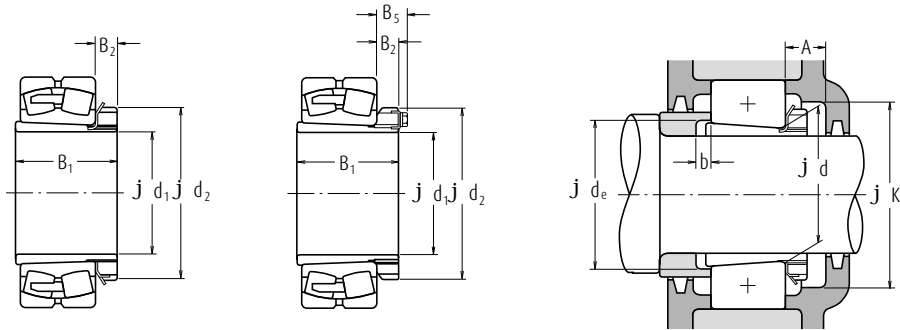

Shaft Diameter (mm)	Nominal Bearing Bore Dia. (mm)	Nominal Numbers Applicable Bearings	Dimensions (mm)				Adapter Sleeve Numbers	Abutment Dimensions (mm)				Mass (kg) approx.
			B ₁	d ₂	B ₂	B ₅		A min.	K min.	d _e min.	b min.	
280	300	23960C AKE4 + H3960	140	360	42	54	A3960	69	380	313	12	20.7
	300	23060C AKE4 + H3060	168	360	42	54	A3060	69	430	313	12	23
	300	23160C AKE4 + H3160	208	380	40	53	A3160	69	430	317	12	30
	300	22260C AKE4 + H3160	208	380	40	53	A3160	69	430	317	32	30
300	300	23260C AKE4 + H3260	240	380	40	53	A3260	69	430	321	12	34
	320	23964C AKE4 + H3964	140	380	42	55	A3964	72	400	334	13	21.8
	320	23064C AKE4 + H3064	171	380	42	55	A3064	72	450	334	13	24.5
	320	23164C AKE4 + H3164	226	400	42	56	A3164	72	450	339	13	35
	320	22264C AKE4 + H3164	226	400	42	56	A3164	72	450	339	39	35
	320	23264C AKE4 + H3264	258	400	42	56	A3264	72	450	343	13	39.5
320	340	23968C AKE4 + H3968	144	400	45	58	A3968	75	430	354	14	24.6
	340	23068C AKE4 + H3068	187	400	45	58	A3068	75	490	355	14	28.5
	340	23168C AKE4 + H3168	254	440	55	72	A3168	75	490	360	14	49.5
340	340	23268C AKE4 + H3268	288	440	55	72	A3268	75	490	364	14	54.5
	360	23972C AKE4 + H3972	144	420	45	58	A3972	75	450	374	14	25.7
	360	23072C AKE4 + H3072	188	420	45	58	A3072	75	510	375	14	30.5
360	360	23172C AKE4 + H3172	259	460	58	75	A3172	75	510	380	14	54
	360	23272C AKE4 + H3272	299	460	58	75	A3272	75	510	385	14	60.5
	380	23976C AKE4 + H3976	164	450	48	62	A3976	82	480	396	15	31.9
	380	23076C AKE4 + H3076	193	450	48	62	A3076	82	540	396	15	36
380	380	23176C AKE4 + H3176	264	490	60	77	A3176	82	540	401	15	61.5
	380	23276C AKE4 + H3276	310	490	60	77	A3276	82	540	405	15	69.5
	400	23980C AKE4 + H3980	168	470	52	66	A3980	86	500	417	15	35.2
	400	23080C AKE4 + H3080	210	470	52	66	A3080	86	580	417	15	41.5
400	400	23180C AKE4 + H3180	272	520	62	82	A3180	86	580	421	15	70.5
	400	23280C AKE4 + H3280	328	520	62	82	A3280	86	580	427	15	81
	420	23984C AKE4 + H3984	168	490	52	66	A3984	86	520	437	16	36.6
	420	23084C AKE4 + H3084	212	490	52	66	A3084	86	600	437	16	43.5
410	420	23184C AKE4 + H3184	304	540	70	90	A3184	86	600	443	16	84
	420	23284C AKE4 + H3284	352	540	70	90	A3284	86	600	448	16	94
	440	23988C AKE4 + H3988	189	520	60	77	A3988	99	550	458	17	58.6
	440	23088C AKE4 + H3088	228	520	60	77	A3088	99	620	458	17	65
440	440	23188C AKE4 + H3188	307	560	70	90	A3188	99	620	464	17	104
	440	23288C AKE4 + H3288	361	560	70	90	A3288	99	620	469	17	118

Shaft Diameter 430 – 470 mm

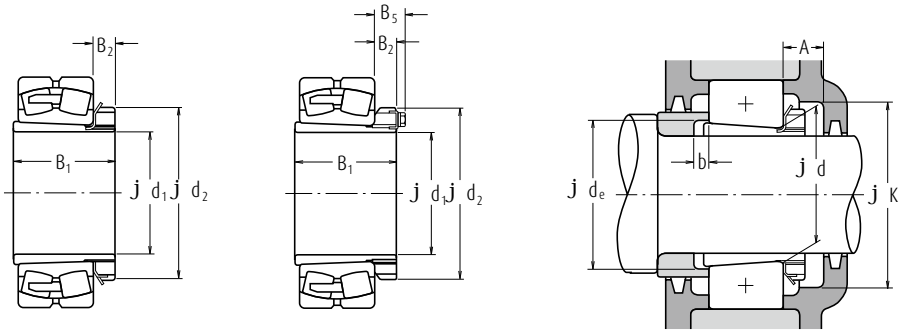

Shaft Diameter (mm)	Nominal Bearing Bore Dia. (mm)	Nominal Numbers	Dimensions (mm)				Adapter Sleeve Numbers	Abutment Dimensions (mm)				Mass (kg)
			B ₁	d ₂	B ₂	B ₅		A min.	K min.	d _e min.	b min.	
430	460	23992C AKE4 + H3992	189	540	60	77	A3992	99	570	478	17	62
	460	23092C AKE4 + H3092	234	540	60	77	A3092	99	650	478	17	69.5
	460	23192C AKE4 + H3192	326	580	75	95	A3192	99	650	485	17	116
	460	23292C AKE4 + H3292	382	580	75	95	A3292	99	650	491	17	132
450	480	23996C AKE4 + H3996	200	560	60	77	A3996	99	600	499	18	67.5
	480	23096C AKE4 + H3096	237	560	60	77	A3096	99	690	499	18	73.5
	480	23196C AKE4 + H3196	335	620	75	95	A3196	99	690	505	18	133
	480	23296C AKE4 + H3296	397	620	75	95	A3296	99	690	512	18	152
470	500	239/500C AKE4 + H39/500	208	580	68	85	A39/500	109	620	519	18	74.6
	500	230/500C AKE4 + H30/500	247	580	68	85	A30/500	109	700	519	18	82
	500	231/500C AKE4 + H31/500	356	630	80	100	A31/500	109	700	527	18	143
	500	232/500C AKE4 + H32/500	428	630	80	100	A32/500	109	700	534	18	166



Withdrawal Sleeves for Rolling Bearings

Shaft Diameter 35 – 85 mm

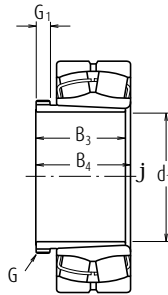

Shaft Diameter (mm)	Nominal Bearing Bore Dia. (mm)	Nominal Numbers	Screw Thread	Dimensions (mm)			Mass (kg)
				B ₃	G ₁	B ₄	
d ₁	d	Applicable Bearings	G	B ₃	G ₁	B ₄	approx.
35	40	21308EAKE4 + AH308	M 45 × 1.5	29	6	32	0.09
	40	22308EAKE4 + AH2308	M 45 × 1.5	40	7	43	0.13
40	45	21309EAKE4 + AH309	M 50 × 1.5	31	6	34	0.11
	45	22309EAKE4 + AH2309	M 50 × 1.5	44	7	47	0.165
45	50	21310EAKE4 + AHX310	M 55 × 2	35	7	38	0.16
	50	22310EAKE4 + AHX2310	M 55 × 2	50	9	53	0.235
50	55	22211EAKE4 + AHX311	M 60 × 2	37	7	40	0.19
	55	21311EAKE4 + AHX311	M 60 × 2	37	7	40	0.19
	55	22311EAKE4 + AHX2311	M 60 × 2	54	10	57	0.285
55	60	22212EAKE4 + AHX312	M 65 × 2	40	8	43	0.215
	60	21312EAKE4 + AHX312	M 65 × 2	40	8	43	0.215
	60	22312EAKE4 + AHX2312	M 65 × 2	58	11	61	0.34
60	65	22213EAKE4 + AH313	M 75 × 2	42	8	45	0.255
	65	21313EAKE4 + AH313	M 75 × 2	42	8	45	0.255
	65	22313EAKE4 + AH2313	M 75 × 2	61	12	64	0.395
65	70	22214EAKE4 + AH314	M 80 × 2	43	8	47	0.28
	70	21314EAKE4 + AH314	M 80 × 2	43	8	47	0.28
	70	22314EAKE4 + AHX2314	M 80 × 2	64	12	68	0.53
70	75	22215EAKE4 + AH315	M 85 × 2	45	8	49	0.315
	75	21315EAKE4 + AH315	M 85 × 2	45	8	49	0.315
	75	22315EAKE4 + AHX2315	M 85 × 2	68	12	72	0.605
75	80	22216EAKE4 + AH316	M 90 × 2	48	8	52	0.365
	80	21316EAKE4 + AH316	M 90 × 2	48	8	52	0.365
	80	22316EAKE4 + AHX2316	M 90 × 2	71	12	75	0.665
80	85	22217EAKE4 + AHX317	M 95 × 2	52	9	56	0.48
	85	21317EAKE4 + AHX317	M 95 × 2	52	9	56	0.48
	85	22317EAKE4 + AHX2317	M 95 × 2	74	13	78	0.745
85	90	22218EAKE4 + AHX318	M 100 × 2	53	9	57	0.52
	90	21318EAKE4 + AHX318	M 100 × 2	53	9	57	0.52
	90	23218CKE4 + AHX3218	M 100 × 2	63	10	67	0.58
	90	22318EAKE4 + AHX2318	M 100 × 2	79	14	83	0.845

Shaft Diameter 90 – 135 mm

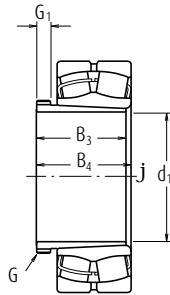

Shaft Diameter (mm)	Nominal Bearing Bore Dia. (mm)	Nominal Numbers	Screw Thread	Dimensions (mm)			Mass (kg)
				d_1	B_3	G_1	
90	95	22219EAKE4 + AHX319	M 105 × 2	57	10	61	0.595
	95	21319CKE4 + AHX319	M 105 × 2	57	10	61	0.595
95	95	22319EAKE4 + AHX2319	M 105 × 2	85	16	89	0.89
	100	21320CKE4 + AHX3120	M 110 × 2	64	11	68	0.70
95	100	22220EAKE4 + AHX320	M 110 × 2	59	10	63	0.66
	100	21320CKE4 + AHX320	M 110 × 2	59	10	63	0.66
	100	23220CKE4 + AHX3220	M 110 × 2	73	11	77	0.77
	100	22320EAKE4 + AHX2320	M 110 × 2	90	16	94	1.0
	110	23122CKE4 + AHX3122	M 120 × 2	68	11	72	0.76
105	110	22222EAKE4 + AHX3122	M 120 × 2	68	11	72	0.76
	110	24122CK30E4 + AH24122	M 115 × 2	82	13	91	0.73
	110	23222CKE4 + AHX3222	M 125 × 2	82	11	86	1.04
	110	22322EAKE4 + AHX2322	M 125 × 2	98	16	102	1.35
115	120	23024CKE4 + AHX3024	M 130 × 2	60	13	64	0.75
	120	24024CK30E4 + AH24024	M 125 × 2	73	13	82	0.70
	120	23124CKE4 + AHX3124	M 130 × 2	75	12	79	0.95
	120	22224EAKE4 + AHX3124	M 130 × 2	75	12	79	0.95
	120	24124CK30E4 + AH24124	M 130 × 2	93	13	102	1.02
	120	23224CKE4 + AHX3224	M 135 × 2	90	13	94	1.3
	120	22324EAKE4 + AHX2324	M 135 × 2	105	17	109	1.6
	125	23026CKE4 + AHX3026	M 140 × 2	67	14	71	0.95
125	130	24026CK30E4 + AH24026	M 135 × 2	83	14	93	0.89
	130	23126CKE4 + AHX3126	M 140 × 2	78	12	82	1.08
	130	22226EAKE4 + AHX3126	M 140 × 2	78	12	82	1.08
	130	24126CK30E4 + AH24126	M 140 × 2	94	14	104	1.14
	130	23226CKE4 + AHX3226	M 145 × 2	98	15	102	1.58
135	130	22326CKE4 + AHX2326	M 145 × 2	115	19	119	1.97
	140	23028CKE4 + AHX3028	M 150 × 2	68	14	73	1.01
	140	24028CK30E4 + AH24028	M 145 × 2	83	14	93	0.96
	140	23128CKE4 + AHX3128	M 150 × 2	83	14	88	1.28
	140	22228CKE4 + AHX3128	M 150 × 2	83	14	88	1.28
	140	24128CK30E4 + AH24128	M 150 × 2	99	14	109	1.3
	140	23228CKE4 + AHX3228	M 155 × 3	104	15	109	1.84
	140	22328CKE4 + AHX2328	M 155 × 3	125	20	130	2.33



Withdrawal Sleeves for Rolling Bearings

Shaft Diameter 145 – 180 mm

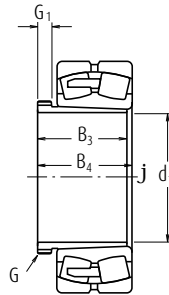

Shaft Diameter (mm)	Nominal Bearing Bore Dia. (mm)	Nominal Numbers		Screw Thread	Dimensions (mm)			Mass (kg)	
		Applicable Bearings			G	B ₃	G ₁		B ₄
d ₁	d							approx.	
145	150	23030CDKE4	+ AHX3030	M 160 × 3	72	15	77	1.15	
	150	24030CK30E4	+ AH24030	M 155 × 3	90	15	101	1.11	
	150	23130CKE4	+ AHX3130	M 165 × 3	96	15	101	1.79	
	150	22230CDKE4	+ AHX3130	M 165 × 3	96	15	101	1.79	
	150	24130CK30E4	+ AH24130	M 160 × 3	115	15	126	1.63	
	150	23230CKE4	+ AHX3230	M 165 × 3	114	17	119	2.22	
	150	22330CAKE4	+ AHX2330	M 165 × 3	135	24	140	2.82	
	150	160	23032CDKE4	+ AH3032	M 170 × 3	77	16	82	2.05
		160	24032CK30E4	+ AH24032	M 170 × 3	95	15	106	2.28
		160	23132CKE4	+ AH3132	M 180 × 3	103	16	108	3.2
160		22232CDKE4	+ AH3132	M 180 × 3	103	16	108	3.2	
160		24132CK30E4	+ AH24132	M 170 × 3	124	15	135	3.03	
160		23232CKE4	+ AH3232	M 180 × 3	124	20	130	4.1	
160		22332CAKE4	+ AH2332	M 180 × 3	140	24	146	4.7	
160		170	23034CDKE4	+ AH3034	M 180 × 3	85	17	90	2.45
		170	24034CK30E4	+ AH24034	M 180 × 3	106	16	117	2.74
		170	23134CKE4	+ AH3134	M 190 × 3	104	16	109	3.4
	170	22234CDKE4	+ AH3134	M 190 × 3	104	16	109	3.4	
	170	24134CK30E4	+ AH24134	M 180 × 3	125	16	136	3.26	
	170	23234CKE4	+ AH3234	M 190 × 3	134	24	140	4.8	
	170	22334CAKE4	+ AH2334	M 190 × 3	146	24	152	5.25	
	170	180	23036CDKE4	+ AH3036	M 190 × 3	92	17	98	2.8
		180	24036CK30E4	+ AH24036	M 190 × 3	116	16	127	3.19
		180	23136CKE4	+ AH3136	M 200 × 3	116	19	122	4.2
180		24136CK30E4	+ AH24136	M 190 × 3	134	16	145	3.74	
180		22236CDKE4	+ AH2236	M 200 × 3	105	17	110	3.75	
180		23236CKE4	+ AH3236	M 200 × 3	140	24	146	5.3	
180		22336CAKE4	+ AH2336	M 200 × 3	154	26	160	5.85	
180		190	23038CAKE4	+ AH3038	Tr 205 × 4	96	18	102	3.35
		190	24038CK30E4	+ AH24038	M 200 × 3	118	18	131	3.47
		190	23138CKE4	+ AH3138	Tr 210 × 4	125	20	131	4.9
	190	24138CK30E4	+ AH24138	M 200 × 3	146	18	159	4.38	
	190	22238CAKE4	+ AH2238	Tr 210 × 4	112	18	117	4.25	
	190	23238CKE4	+ AH3238	Tr 210 × 4	145	25	152	5.9	
	190	22338CAKE4	+ AH2338	Tr 210 × 4	160	26	167	6.65	

Shaft Diameter 190 – 260 mm

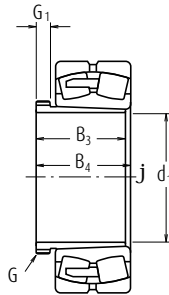

Shaft Diameter (mm)	Nominal Bearing Bore Dia. (mm)	Nominal Numbers	Screw Thread	Dimensions (mm)			Mass (kg)
				d_1	B_3	B_4	
190	200	23040CAKE4 + AH3040	Tr 215 × 4	102	19	108	3.8
	200	24040CK30E4 + AH24040	Tr 210 × 4	127	18	140	3.92
	200	23140CKE4 + AH3140	Tr 220 × 4	134	21	140	5.5
	200	24140CK30E4 + AH24140	Tr 210 × 4	158	18	171	5.0
	200	22240CAKE4 + AH2240	Tr 220 × 4	118	19	123	4.7
	200	23240CKE4 + AH3240	Tr 220 × 4	153	25	160	6.7
200	200	22340CAKE4 + AH2340	Tr 220 × 4	170	30	177	7.55
	220	23044CAKE4 + AH3044	Tr 235 × 4	111	20	117	7.4
	220	24044CK30E4 + AH24044	Tr 230 × 4	138	20	152	8.23
	220	23144CKE4 + AH3144	Tr 240 × 4	145	23	151	10.5
	220	24144CK30E4 + AH24144	Tr 230 × 4	170	20	184	10.3
	220	22244CAKE4 + AH2244	Tr 240 × 4	130	20	136	9.1
220	220	23244CKE4 + AH2344	Tr 240 × 4	181	30	189	13.5
	220	22344CAKE4 + AH2344	Tr 240 × 4	181	30	189	13.5
	240	23048CAKE4 + AH3048	Tr 260 × 4	116	21	123	8.75
	240	24048CK30E4 + AH24048	Tr 250 × 4	138	20	153	9.0
	240	23148CKE4 + AH3148	Tr 260 × 4	154	25	161	12
	240	24148CK30E4 + AH24148	Tr 260 × 4	180	20	195	12.6
240	240	22248CAKE4 + AH2248	Tr 260 × 4	144	21	150	11
	240	23248CKE4 + AH2348	Tr 260 × 4	189	30	197	15.5
	240	22348CAKE4 + AH2348	Tr 260 × 4	189	30	197	15.5
	260	23052CAKE4 + AH3052	Tr 280 × 4	128	23	135	10.5
	260	24052CAK30E4 + AH24052	Tr 270 × 4	162	22	178	11.7
	260	23152CAKE4 + AH3152	Tr 290 × 4	172	26	179	16
260	260	24152CAK30E4 + AH24152	Tr 280 × 4	202	22	218	15.5
	260	22252CAKE4 + AH2252	Tr 290 × 4	155	23	161	14
	260	23252CAKE4 + AH2352	Tr 290 × 4	205	30	213	19.5
	260	22352CAKE4 + AH2352	Tr 290 × 4	205	30	213	19.5
	280	23056CAKE4 + AH3056	Tr 300 × 4	131	24	139	12
	280	24056CAK30E4 + AH24056	Tr 290 × 4	162	22	179	12.6
280	280	23156CAKE4 + AH3156	Tr 310 × 5	175	28	183	17.5
	280	24156CAK30E4 + AH24156	Tr 300 × 4	202	22	219	16.8
	280	22256CAKE4 + AH2256	Tr 310 × 5	155	24	163	15
	280	23256CAKE4 + AH2356	Tr 310 × 5	212	30	220	21.5
	280	22356CAKE4 + AH2356	Tr 310 × 5	212	30	220	21.5



Withdrawal Sleeves for Rolling Bearings

Shaft Diameter 280 – 380 mm

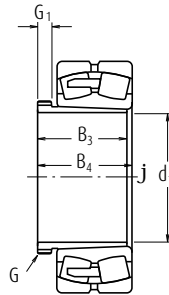

Shaft Diameter (mm)	Nominal Bearing Bore Dia. (mm)	Nominal Numbers	Screw Thread	Dimensions (mm)			Mass (kg)
				B ₃	G ₁	B ₄	
d ₁	d	Applicable Bearings	G	B ₃	G ₁	B ₄	approx.
280	300	23060CAKE4 + AH3060	Tr 320 × 5	145	26	153	14.5
	300	24060CAK30E4 + AH24060	Tr 310 × 5	184	24	202	15.5
	300	23160CAKE4 + AH3160	Tr 330 × 5	192	30	200	21
	300	24160CAK30E4 + AH24160	Tr 320 × 5	224	24	242	20.3
	300	22260CAKE4 + AH2260	Tr 330 × 5	170	26	178	18
300	300	23260CAKE4 + AH3260	Tr 330 × 5	228	34	236	20
	320	23064CAKE4 + AH3064	Tr 345 × 5	149	27	157	16
	320	24064CAK30E4 + AH24064	Tr 330 × 5	184	24	202	16.4
	320	23164CAKE4 + AH3164	Tr 350 × 5	209	31	217	24.5
	320	24164CAK30E4 + AH24164	Tr 340 × 5	242	24	260	23.5
320	320	23264CAKE4 + AH3264	Tr 350 × 5	246	36	254	25
	340	23068CAKE4 + AH3068	Tr 365 × 5	162	28	171	19.5
	340	24068CAK30E4 + AH24068	Tr 360 × 5	206	26	225	21.2
	340	23168CAKE4 + AH3168	Tr 370 × 5	225	33	234	29
	340	24168CAK30E4 + AH24168	Tr 360 × 5	269	26	288	28.3
340	340	23268CAKE4 + AH3268	Tr 370 × 5	264	38	273	35.5
	360	23072CAKE4 + AH3072	Tr 385 × 5	167	30	176	21
	360	24072CAK30E4 + AH24072	Tr 380 × 5	206	26	226	22.5
	360	23172CAKE4 + AH3172	Tr 400 × 5	229	35	238	33
	360	24172CAK30E4 + AH24172	Tr 380 × 5	269	26	289	30
360	360	23272CAKE4 + AH3272	Tr 400 × 5	274	40	283	41.5
	380	23076CAKE4 + AH3076	Tr 410 × 5	170	31	180	23.5
	380	24076CAK30E4 + AH24076	Tr 400 × 5	208	28	228	24.1
	380	23176CAKE4 + AH3176	Tr 420 × 5	232	36	242	35.5
	380	24176CAK30E4 + AH24176	Tr 400 × 5	271	28	291	32.1
380	380	23276CAKE4 + AH3276	Tr 420 × 5	284	42	294	45.5
	400	23080CAKE4 + AH3080	Tr 430 × 5	183	33	193	27.5
	400	24080CAK30E4 + AH24080	Tr 420 × 5	228	28	248	28
	400	23180CAKE4 + AH3180	Tr 440 × 5	240	38	250	39.5
	400	24180CAK30E4 + AH24180	Tr 420 × 5	278	28	298	34.8
	400	23280CAKE4 + AH3280	Tr 440 × 5	302	44	312	51.5

Shaft Diameter 400 – 480 mm

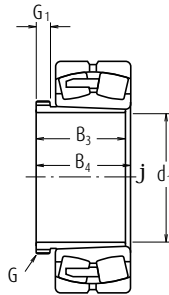

Shaft Diameter (mm)	Nominal Bearing Bore Dia. (mm)	Nominal Numbers		Screw Thread	Dimensions (mm)			Mass (kg)
		d_1	d		Applicable Bearings	G	B_3	
400	420	23084CAKE4	+ AH3084	Tr 450 × 5	186	34	196	29
	420	24084CAK30E4	+ AH24084	Tr 440 × 5	230	30	252	29.8
	420	23184CAKE4	+ AH3184	Tr 460 × 5	266	40	276	46.5
	420	24184CAK30E4	+ AH24184	Tr 440 × 5	310	30	332	41.4
	420	23284CAKE4	+ AH3284	Tr 460 × 5	321	46	331	59
420	440	23088CAKE4	+ AHX3088	Tr 470 × 5	194	35	205	42
	440	24088CAK30E4	+ AH24088	Tr 460 × 5	242	30	264	33
	440	23188CAKE4	+ AHX3188	Tr 480 × 5	270	42	281	50
	440	24188CAK30E4	+ AH24188	Tr 460 × 5	310	30	332	43.5
	440	23288CAKE4	+ AHX3288	Tr 480 × 5	330	48	341	64
440	460	23092CAKE4	+ AHX3092	Tr 490 × 5	202	37	213	46
	460	24092CAK30E4	+ AH24092	Tr 480 × 5	250	32	273	35.9
	460	23192CAKE4	+ AHX3192	Tr 510 × 6	285	43	296	58
	460	24192CAK30E4	+ AH24192	Tr 480 × 5	332	32	355	49.7
	460	23292CAKE4	+ AHX3292	Tr 510 × 6	349	50	360	74.5
460	480	23096CAKE4	+ AHX3096	Tr 520 × 6	205	38	217	51
	480	24096CAK30E4	+ AH24096	Tr 500 × 5	250	32	273	37.5
	480	23196CAKE4	+ AHX3196	Tr 530 × 6	295	45	307	63
	480	24196CAK30E4	+ AH24196	Tr 500 × 5	340	32	363	53
	480	23296CAKE4	+ AHX3296	Tr 530 × 6	364	52	376	82
480	500	230/500CAKE4	+ AHX30/500	Tr 540 × 6	209	40	221	54.5
	500	240/500CAK30E4	+ AH240/500	Tr 530 × 6	253	35	276	41.9
	500	231/500CAKE4	+ AHX31/500	Tr 550 × 6	313	47	325	71
	500	241/500CAK30E4	+ AH241/500	Tr 530 × 6	360	35	383	61.2
	500	232/500CAKE4	+ AHX32/500	Tr 550 × 6	393	54	405	94.5



Nuts for Rolling Bearings

(For Adapters and Shafts)

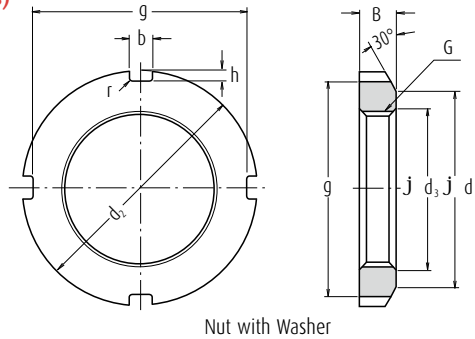

Nut with Washer

Units : mm

Nominal Numbers	Nut Series AN									Reference			
	Screw Threads	Basic Dimensions							Mass (kg) approx.	Adapter (1) Sleeve Bore Dia. Numbers	Washer Numbers	Shaft Dia.	
		G	d ₂	d ₁	g	b	h	d ₃					B
AN 02	M 15×1	25	21	21	4	2	15.5	5	0.4	0.010	—	AW 02 X	15
AN 03	M 17×1	28	24	24	4	2	17.5	5	0.4	0.013	—	AW 03 X	17
AN 04	M 20×1	32	26	28	4	2	20.5	6	0.4	0.019	04	AW 04 X	20
AN 05	M 25×1.5	38	32	34	5	2	25.8	7	0.4	0.025	05	AW 05 X	25
AN 06	M 30×1.5	45	38	41	5	2	30.8	7	0.4	0.043	06	AW 06 X	30
AN 07	M 35×1.5	52	44	48	5	2	35.8	8	0.4	0.053	07	AW 07 X	35
AN 08	M 40×1.5	58	50	53	6	2.5	40.8	9	0.5	0.085	08	AW 08 X	40
AN 09	M 45×1.5	65	56	60	6	2.5	45.8	10	0.5	0.119	09	AW 09 X	45
AN 10	M 50×1.5	70	61	65	6	2.5	50.8	11	0.5	0.148	10	AW 10 X	50
AN 11	M 55×2	75	67	69	7	3	56	11	0.5	0.158	11	AW 11 X	55
AN 12	M 60×2	80	73	74	7	3	61	11	0.5	0.174	12	AW 12 X	60
AN 13	M 65×2	85	79	79	7	3	66	12	0.5	0.203	13	AW 13 X	65
AN 14	M 70×2	92	85	85	8	3.5	71	12	0.5	0.242	14	AW 14 X	70
AN 15	M 75×2	98	90	91	8	3.5	76	13	0.5	0.287	15	AW 15 X	75
AN 16	M 80×2	105	95	98	8	3.5	81	15	0.6	0.395	16	AW 16 X	80
AN 17	M 85×2	110	102	103	8	3.5	86	16	0.6	0.45	17	AW 17 X	85
AN 18	M 90×2	120	108	112	10	4	91	16	0.6	0.555	18	AW 18 X	90
AN 19	M 95×2	125	113	117	10	4	96	17	0.6	0.66	19	AW 19 X	95
AN 20	M 100×2	130	120	122	10	4	101	18	0.6	0.70	20	AW 20 X	100
AN 21	M 105×2	140	126	130	12	5	106	18	0.7	0.845	21	AW 21 X	105
AN 22	M 110×2	145	133	135	12	5	111	19	0.7	0.965	22	AW 22 X	110
AN 23	M 115×2	150	137	140	12	5	116	19	0.7	1.01	—	AW 23	115
AN 24	M 120×2	155	138	145	12	5	121	20	0.7	1.08	24	AW 24	120
AN 25	M 125×2	160	148	150	12	5	126	21	0.7	1.19	—	AW 25	125

Note (1) Applicable to adapter sleeve Series A31, A2, A3, and A23.

Remark The basic design and dimensions of screw threads are in accordance with JIS B 0205.

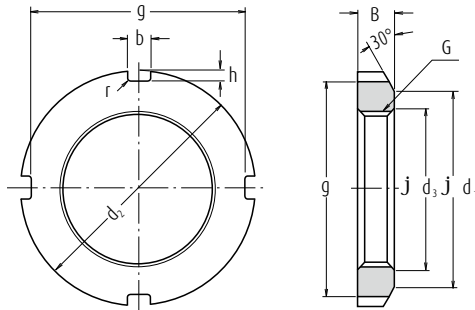

Nut with Washer

Units : mm

Nominal Numbers	Nut Series AN										Reference		
	Screw Threads	Basic Dimensions								Mass (kg) approx.	Adapter (1) Sleeve Bore Dia. Numbers	Washer Numbers	Shaft Dia.
		G	d ₂	d ₁	g	b	h	d ₃	B				
AN 26	M 130×2	165	149	155	12	5	131	21	0.7	1.25	26	AW 26	130
AN 27	M 135×2	175	160	163	14	6	136	22	0.7	1.55	—	AW 27	135
AN 28	M 140×2	180	160	168	14	6	141	22	0.7	1.56	28	AW 28	140
AN 29	M 145×2	190	172	178	14	6	146	24	0.7	2.0	—	AW 29	145
AN 30	M 150×2	195	171	183	14	6	151	24	0.7	2.03	30	AW 30	150
AN 31	M 155×3	200	182	186	16	7	156.5	25	0.7	2.21	—	—	—
AN 32	M 160×3	210	182	196	16	7	161.5	25	0.7	2.59	32	AW 32	160
AN 33	M 165×3	210	193	196	16	7	166.5	26	0.7	2.43	—	—	—
AN 34	M 170×3	220	193	206	16	7	171.5	26	0.7	2.8	34	AW 34	170
AN 36	M 180×3	230	203	214	18	8	181.5	27	0.7	3.05	36	AW 36	180
AN 38	M 190×3	240	214	224	18	8	191.5	28	0.7	3.4	38	AW 38	190
AN 40	M 200×3	250	226	234	18	8	201.5	29	0.7	3.7	40	AW 40	200
Nut Series ANL													
ANL 24	M 120×2	145	133	135	12	5	121	20	0.7	0.78	24	AWL 24	120
ANL 26	M 130×2	155	143	145	12	5	131	21	0.7	0.88	26	AWL 26	130
ANL 28	M 140×2	165	151	153	14	6	141	22	0.7	0.99	28	AWL 28	140
ANL 30	M 150×2	180	164	168	14	6	151	24	0.7	1.38	30	AWL 30	150
ANL 32	M 160×3	190	174	176	16	7	161.5	25	0.7	1.56	32	AWL 32	160
ANL 34	M 170×3	200	184	186	16	7	171.5	26	0.7	1.72	34	AWL 34	170
ANL 36	M 180×3	210	192	194	18	8	181.5	27	0.7	1.95	36	AWL 36	180
ANL 38	M 190×3	220	202	204	18	8	191.5	28	0.7	2.08	38	AWL 38	190
ANL 40	M 200×3	240	218	224	18	8	201.5	29	0.7	2.98	40	AWL 40	200

Note (1) Series AN is applicable to adapter sleeve Series A31 and A23.
Series ANL is applicable to adapter sleeve Series A30.

Remark The basic design and dimensions of screw threads are in accordance with JIS B 0205.



Sleeves

Nuts for Rolling Bearings

(For Adapters and Shafts)

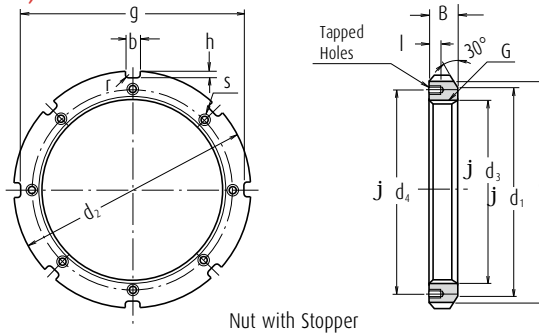

Nut with Stopper

Units : mm

Nominal Numbers	Nut Series AN												Reference			
	Screw Threads	Basic Dimensions							Tapped Holes				Mass (kg) approx.	Adapter (1) Sleeve Bore Dia. Numbers	Stopper Numbers	Shaft Dia.
		G	d ₂	d ₁	g	b	h	d ₃	B	r max.	l	Screw Threads (S)				
AN 44	Tr 220×4	280	250	260	20	10	222	32	0.8	15	M 8×1.25	238	5.2	44	AL 44	220
AN 48	Tr 240×4	300	270	280	20	10	242	34	0.8	15	M 8×1.25	258	5.95	48	AL 44	240
AN 52	Tr 260×4	330	300	306	24	12	262	36	0.8	18	M 10×1.5	281	8.05	52	AL 52	260
AN 56	Tr 280×4	350	320	326	24	12	282	38	0.8	18	M 10×1.5	301	9.05	56	AL 52	280
AN 60	Tr 300×4	380	340	356	24	12	302	40	0.8	18	M 10×1.5	326	11.8	60	AL 60	300
AN 64	Tr 320×5	400	360	376	24	12	322.5	42	0.8	18	M 10×1.5	345	13.1	64	AL 64	320
AN 68	Tr 340×5	440	400	410	28	15	342.5	55	1	21	M 12×1.75	372	23.1	68	AL 68	340
AN 72	Tr 360×5	460	420	430	28	15	362.5	58	1	21	M 12×1.75	392	25.1	72	AL 68	360
AN 76	Tr 380×5	490	450	454	32	18	382.5	60	1	21	M 12×1.75	414	31	76	AL 76	380
AN 80	Tr 400×5	520	470	484	32	18	402.5	62	1	27	M 16×2	439	37	80	AL 80	400
AN 84	Tr 420×5	540	490	504	32	18	422.5	70	1	27	M 16×2	459	43.5	84	AL 80	420
AN 88	Tr 440×5	560	510	520	36	20	442.5	70	1	27	M 16×2	477	45	88	AL 88	440
AN 92	Tr 460×5	580	540	540	36	20	462.5	75	1	27	M 16×2	497	50.5	92	AL 88	460
AN 96	Tr 480×5	620	560	580	36	20	482.5	75	1	27	M 16×2	527	62	96	AL 96	480
AN 100	Tr 500×5	630	580	584	40	23	502.5	80	1	27	M 16×2	539	63.5	/500	AL 100	500
Nut Series ANL																
ANL 44	Tr 220×4	260	242	242	20	9	222	30	0.8	12	M 6×1	229	3.1	44	ALL 44	220
ANL 48	Tr 240×4	290	270	270	20	10	242	34	0.8	15	M 8×1.25	253	5.15	48	ALL 48	240
ANL 52	Tr 260×4	310	290	290	20	10	262	34	0.8	15	M 8×1.25	273	5.65	52	ALL 48	260
ANL 56	Tr 280×4	330	310	310	24	10	282	38	0.8	15	M 8×1.25	293	6.8	56	ALL 56	280
ANL 60	Tr 300×4	360	336	336	24	12	302	42	0.8	15	M 8×1.25	316	9.6	60	ALL 60	300
ANL 64	Tr 320×5	380	356	356	24	12	322.5	42	0.8	15	M 8×1.25	335	9.95	64	ALL 64	320
ANL 68	Tr 340×5	400	376	376	24	12	342.5	45	1	15	M 8×1.25	355	11.7	68	ALL 64	340
ANL 72	Tr 360×5	420	394	394	28	13	362.5	45	1	15	M 8×1.25	374	12	72	ALL 72	360
ANL 76	Tr 380×5	450	422	422	28	14	382.5	48	1	18	M 10×1.5	398	14.9	76	ALL 76	380
ANL 80	Tr 400×5	470	442	442	28	14	402.5	52	1	18	M 10×1.5	418	16.9	80	ALL 76	400
ANL 84	Tr 420×5	490	462	462	32	14	422.5	52	1	18	M 10×1.5	438	17.4	84	ALL 84	420
ANL 88	Tr 440×5	520	490	490	32	15	442.5	60	1	21	M 12×1.75	462	26.2	88	ALL 88	440
ANL 92	Tr 460×5	540	510	510	32	15	462.5	60	1	21	M 12×1.75	482	28	92	ALL 88	460
ANL 96	Tr 480×5	560	530	530	36	15	482.5	60	1	21	M 12×1.75	502	29.5	96	ALL 96	480
ANL 100	Tr 500×5	580	550	550	36	15	502.5	68	1	21	M 12×1.75	522	33.5	/500	ALL 96	500

Note (1) Series AN is applicable to adapter sleeve Series A31, A32 and A23. Series ANL is applicable to adapter sleeve Series A30.

- Remarks**
1. The basic design and dimensions of screw threads are in accordance with JIS B 0216.
 2. The basic design and dimensions of threads in tapped holes are in accordance with JIS B 0205.

(For Withdrawal Sleeves)

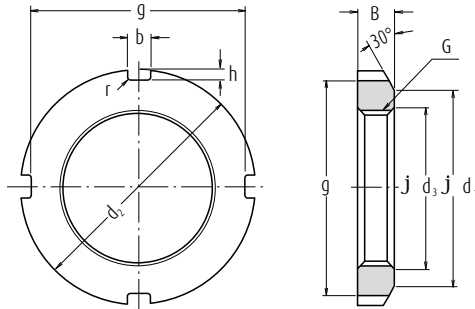

Units : mm

Nominal Numbers	Nut Series HN									Reference				
	Screw Threads	Basic Dimensions							Mass (kg) approx.	Withdrawal Sleeve Numbers				
		G	d ₂	d ₁	g	b	h	d ₃		B	r max.	AH 31	AH 22	AH 32
HN 42	Tr 210×4	270	238	250	20	10	212	30	0.8	4.75	AH 3138	AH 2238	AH 3238	AH 2338
HN 44	Tr 220×4	280	250	260	20	10	222	32	0.8	5.35	AH 3140	AH 2240	AH 3240	AH 2340
HN 48	Tr 240×4	300	270	280	20	10	242	34	0.8	6.2	AH 3144	AH 2244	—	AH 2344
HN 52	Tr 260×4	330	300	306	24	12	262	36	0.8	8.55	AH 3148	AH 2248	—	AH 2348
HN 58	Tr 290×4	370	330	346	24	12	292	40	0.8	11.8	AH 3152	AH 2252	—	AH 2352
HN 62	Tr 310×5	390	350	366	24	12	312.5	42	0.8	13.4	AH 3156	AH 2256	—	AH 2356
HN 66	Tr 330×5	420	380	390	28	15	332.5	52	1	20.4	AH 3160	AH 2260	AH 3260	—
HN 70	Tr 350×5	450	410	420	28	15	352.5	55	1	25.2	AH 3164	AH 2264	AH 3264	—
HN 74	Tr 370×5	470	430	440	28	15	372.5	58	1	28.2	AH 3168	—	AH 3268	—
HN 80	Tr 400×5	520	470	484	32	18	402.5	62	1	40	AH 3172	—	AH 3272	—
HN 84	Tr 420×5	540	490	504	32	18	422.5	70	1	46.9	AH 3176	—	AH 3276	—
HN 88	Tr 440×5	560	510	520	36	20	442.5	70	1	48.5	AH 3180	—	AH 3280	—
HN 92	Tr 460×5	580	540	540	36	20	462.5	75	1	55	AH 3184	—	AH 3284	—
HN 96	Tr 480×5	620	560	580	36	20	482.5	75	1	67	AHX 3188	—	AHX 3288	—
HN 102	Tr 510×6	650	590	604	40	23	513	80	1	75	AHX 3192	—	AHX 3292	—
HN 106	Tr 530×6	670	610	624	40	23	533	80	1	78	AHX 3196	—	AHX 3296	—
HN 110	Tr 550×6	700	640	654	40	23	553	80	1	92.5	AHX 31/500	—	AHX 32/500	—
		Nut Series HNL									AH 30	AH 2		
HNL 41	Tr 205×4	250	232	234	18	8	207	30	0.8	3.45	AH 3038	AH 238		
HNL 43	Tr 215×4	260	242	242	20	9	217	30	0.8	3.7	AH 3040	AH 240		
HNL 47	Tr 235×4	280	262	262	20	9	237	34	0.8	4.6	AH 3044	AH 244		
HNL 52	Tr 260×4	310	290	290	20	10	262	34	0.8	5.8	AH 3048	AH 248		
HNL 56	Tr 280×4	330	310	310	24	10	282	38	0.8	6.7	AH 3052	AH 252		
HNL 60	Tr 300×4	360	336	336	24	12	302	42	0.8	9.6	AH 3056	AH 256		
HNL 64	Tr 320×5	380	356	356	24	12	322.5	42	1	10.3	AH 3060	—		
HNL 69	Tr 345×5	410	384	384	28	13	347.5	45	1	11.5	AH 3064	—		
HNL 73	Tr 365×5	430	404	404	28	13	367.5	48	1	14.2	AH 3068	—		
HNL 77	Tr 385×5	450	422	422	28	14	387.5	48	1	15	AH 3072	—		
HNL 82	Tr 410×5	480	452	452	32	14	412.5	52	1	19	AH 3076	—		
HNL 86	Tr 430×5	500	472	472	32	14	432.5	52	1	19.8	AH 3080	—		
HNL 90	Tr 450×5	520	490	490	32	15	452.5	60	1	23.8	AH 3084	—		
HNL 94	Tr 470×5	540	510	510	32	15	472.5	60	1	25	AHX 3088	—		
HNL 98	Tr 490×5	580	550	550	36	15	492.5	60	1	34	AHX 3092	—		
HNL 104	Tr 520×6	600	570	570	36	15	523	68	1	37	AHX 3096	—		
HNL 108	Tr 540×6	630	590	590	40	20	543	68	1	43.5	AHX 30/500	—		

- Remarks**
1. The basic design and dimensions of screw threads are in accordance with JIS B 0216.
 2. The number of notches in the nut may be bigger than that shown in the above figure.



Nuts for Rolling Bearings

(Combination of Withdrawal Sleeves and Nuts)

Nominal Numbers	Reference						
	Withdrawal Sleeve Numbers						
	AH 30	AH 31	AH 2	AH 22	AH 32	AH 3	AH 23
AN 09	—	—	AH 208	—	—	AH 308	AH 2308
AN 10	—	—	AH 209	—	—	AH 309	AH 2309
AN 11	—	—	AH 210	—	—	AHX 310	AHX 2310
AN 12	—	—	AH 211	—	—	AHX 311	AHX 2311
AN 13	—	—	AH 212	—	—	AHX 312	AHX 2312
AN 14	—	—	—	—	—	—	—
AN 15	—	—	AH 213	—	—	AH 313	AH 2313
AN 16	—	—	AH 214	—	—	AH 314	AHX 2314
AN 17	—	—	AH 215	—	—	AH 315	AHX 2315
AN 18	—	—	AH 216	—	—	AH 316	AHX 2316
AN 19	—	—	AH 217	—	—	AHX 317	AHX 2317
AN 20	—	—	AH 218	—	AHX 3218	AHX 318	AHX 2318
AN 21	—	—	AH 219	—	—	AHX 319	AHX 2319
AN 22	—	—	AH 220	—	AHX 3220	AHX 320	AHX 2320
AN 23	—	—	AH 221	—	—	AHX 321	—
AN 24	—	AHX 3122	AH 222	—	—	AHX 322	—
AN 25	—	—	—	—	AHX 3222	—	AHX 2322
AN 26	AHX 3024	AHX 3124	AH 224	—	—	AHX 324	—
AN 27	—	—	—	—	AHX 3224	—	AHX 2324
AN 28	AHX 3026	AHX 3126	AH 226	—	—	AHX 326	—
AN 29	—	—	—	—	AHX 3226	—	AHX 2326
AN 30	AHX 3028	AHX 3128	AH 228	—	—	AHX 328	—
AN 31	—	—	—	—	AHX 3228	—	AHX 2328
AN 32	AHX 3030	—	AH 230	—	—	—	—
AN 33	—	AHX 3130	—	—	AHX 3230	AHX 330	AHX 2330
AN 34	AH 3032	—	AH 232	—	—	—	—
AN 36	AH 3034	AH 3132	AH 234	—	AH 3232	AH 332	AH 2332
AN 38	AH 3036	AH 3134	AH 236	—	AH 3234	AH 334	AH 2334
AN 40	—	AH 3136	—	AH 2236	AH 3236	—	AH 2336

Stoppers for Nuts

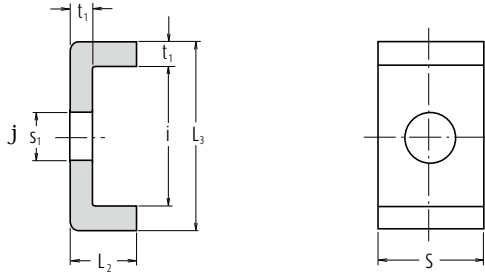

Units : mm

Nominal Numbers	Stopper Series AL							Reference
	Basic Dimensions						Mass (kg) per 100 pcs	Nut Numbers
	t ₁	S	L ₂	s ₁	i	L ₃	approx.	
AL 44	4	20	12	9	22.5	30.5	2.6	AN 44, AN 48
AL 52	4	24	12	12	25.5	33.5	3.4	AN 52, AN 56
AL 60	4	24	12	12	30.5	38.5	3.8	AN 60
AL 64	5	24	15	12	31	41	5.35	AN 64
AL 68	5	28	15	14	38	48	6.65	AN 68, AN 72
AL 76	5	32	15	14	40	50	7.95	AN 76
AL 80	5	32	15	18	45	55	8.2	AN 80, AN 84
AL 88	5	36	15	18	43	53	9.0	AN 88, AN 92
AL 96	5	36	15	18	53	63	10.4	AN 96
AL 100	5	40	15	18	45	55	10.5	AN 100
Stopper Series ALL								
ALL 44	4	20	12	7	13.5	21.5	2.12	ANL 44
ALL 48	4	20	12	9	17.5	25.5	2.29	ANL 48, ANL 52
ALL 56	4	24	12	9	17.5	25.5	2.92	ANL 56
ALL 60	4	24	12	9	20.5	28.5	3.15	ANL 60
ALL 64	5	24	15	9	21	31	4.55	ANL 64, ANL 68
ALL 72	5	28	15	9	20	30	5.05	ANL 72
ALL 76	5	28	15	12	24	34	5.3	ANL 76, ANL 80
ALL 84	5	32	15	12	24	34	6.1	ANL 84
ALL 88	5	32	15	14	28	38	6.45	ANL 88, ANL 92
ALL 96	5	36	15	14	28	38	7.3	ANL 96, ANL 100



Lock-Washers for Rolling Bearings

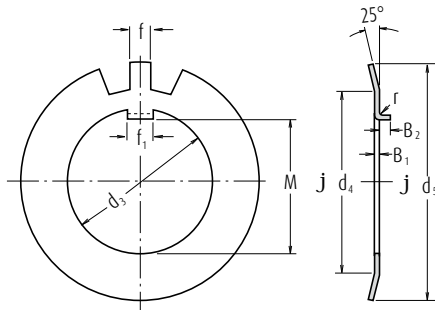

Bent-Tab

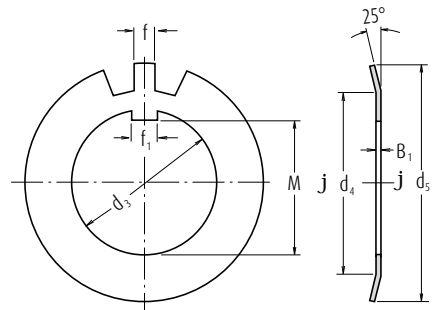

Straight-Tab

Units : mm

Nominal Numbers		Lock-washer Series AW										Reference			
		Basic Dimensions										No. of Teeth	Mass (kg) per 100 pcs approx.	Adapter (1) Sleeve Bore Dia. Numbers	Nut Numbers
Bent-Tab	Straight-Tab	d ₃	M	f ₁	B ₁	f	d ₄	d ₅	Bent-Tab r	B ₂					
AW 02	AW 02 X	15	13.5	4	1	4	21	28	1	2.5	13	0.253	—	AN 02	15
AW 03	AW 03 X	17	15.5	4	1	4	24	32	1	2.5	13	0.315	—	AN 03	17
AW 04	AW 04 X	20	18.5	4	1	4	26	36	1	2.5	13	0.35	04	AN 04	20
AW 05	AW 05 X	25	23	5	1.2	5	32	42	1	2.5	13	0.64	05	AN 05	25
AW 06	AW 06 X	30	27.5	5	1.2	5	38	49	1	2.5	13	0.78	06	AN 06	30
AW 07	AW 07 X	35	32.5	6	1.2	5	44	57	1	2.5	15	1.04	07	AN 07	35
AW 08	AW 08 X	40	37.5	6	1.2	6	50	62	1	2.5	15	1.23	08	AN 08	40
AW 09	AW 09 X	45	42.5	6	1.2	6	56	69	1	2.5	17	1.52	09	AN 09	45
AW 10	AW 10 X	50	47.5	6	1.2	6	61	74	1	2.5	17	1.6	10	AN 10	50
AW 11	AW 11 X	55	52.5	8	1.2	7	67	81	1	4	17	1.96	11	AN 11	55
AW 12	AW 12 X	60	57.5	8	1.5	7	73	86	1.2	4	17	2.53	12	AN 12	60
AW 13	AW 13 X	65	62.5	8	1.5	7	79	92	1.2	4	19	2.9	13	AN 13	65
AW 14	AW 14 X	70	66.5	8	1.5	8	85	98	1.2	4	19	3.35	14	AN 14	70
AW 15	AW 15 X	75	71.5	8	1.5	8	90	104	1.2	4	19	3.55	15	AN 15	75
AW 16	AW 16 X	80	76.5	10	1.8	8	95	112	1.2	4	19	4.65	16	AN 16	80
AW 17	AW 17 X	85	81.5	10	1.8	8	102	119	1.2	4	19	5.25	17	AN 17	85
AW 18	AW 18 X	90	86.5	10	1.8	10	108	126	1.2	4	19	6.25	18	AN 18	90
AW 19	AW 19 X	95	91.5	10	1.8	10	113	133	1.2	4	19	6.7	19	AN 19	95
AW 20	AW 20 X	100	96.5	12	1.8	10	120	142	1.2	6	19	7.65	20	AN 20	100
AW 21	AW 21 X	105	100.5	12	1.8	12	126	145	1.2	6	19	8.25	21	AN 21	105
AW 22	AW 22 X	110	105.5	12	1.8	12	133	154	1.2	6	19	9.4	22	AN 22	110
AW 23	AW 23 X	115	110.5	12	2	12	137	159	1.5	6	19	10.8	—	AN 23	115
AW 24	AW 24 X	120	115	14	2	12	138	164	1.5	6	19	10.5	24	AN 24	120
AW 25	AW 25 X	125	120	14	2	12	148	170	1.5	6	19	11.8	—	AN 25	125

Note (1) Applicable to adapter sleeve Series A31, A2, A3, and A23.

Remark Lock-washers with straight tabs shall be used with adapter sleeves having narrow slits. For adapter sleeves having wide slits, either type of lock-washer may be used.

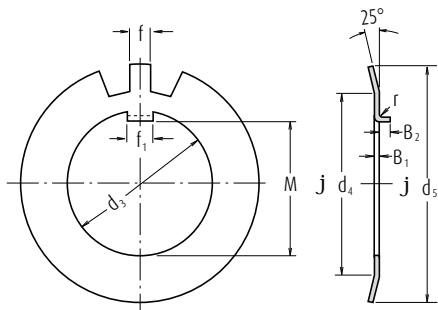

Bent-Tab

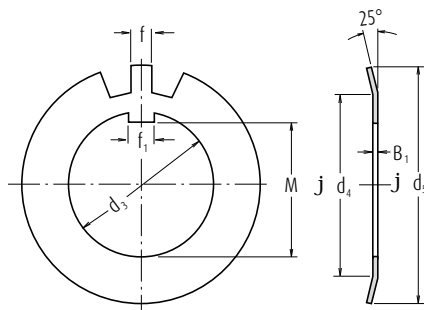

Straight-Tab

Units : mm

Nominal Numbers		Lock-washer Series AW										Reference			
Bent-Tab	Straight-Tab	Basic Dimensions									No. of Teeth	Mass (kg) per 100 pcs approx.	Adapter (1) Sleeve Bore Dia. Numbers	Nut Numbers	Shaft Dia.
		d ₃	M	f ₁	B ₁	f	d ₄	d ₅	Bent-Tab r	B ₂					
AW 26	AW 26 X	130	125	14	2	12	149	175	1.5	6	19	11.3	26	AN 26	130
AW 27	AW 27 X	135	130	14	2	14	160	185	1.5	6	19	14.4	—	AN 27	135
AW 28	AW 28 X	140	135	16	2	14	160	192	1.5	8	19	14.2	28	AN 28	140
AW 29	AW 29 X	145	140	16	2	14	172	202	1.5	8	19	16.8	—	AN 29	145
AW 30	AW 30 X	150	145	16	2	14	171	205	1.5	8	19	15.9	30	AN 30	150
AW 31	AW 31 X	155	147.5	16	2.5	16	182	212	1.5	8	19	20.9	—	AN 31	155
AW 32	AW 32 X	160	154	18	2.5	16	182	217	1.5	8	19	22.2	32	AN 32	160
AW 33	AW 33 X	165	157.5	18	2.5	16	193	222	1.5	8	19	24.1	—	AN 33	165
AW 34	AW 34 X	170	164	18	2.5	16	193	232	1.5	8	19	24.7	34	AN 34	170
AW 36	AW 36 X	180	174	20	2.5	18	203	242	1.5	8	19	26.8	36	AN 36	180
AW 38	AW 38 X	190	184	20	2.5	18	214	252	1.5	8	19	27.8	38	AN 38	190
AW 40	AW 40 X	200	194	20	2.5	18	226	262	1.5	8	19	29.3	40	AN 40	200
		Washer Series AWL													
AWL 24	AWL 24 X	120	115	14	2	12	133	155	1.5	6	19	7.7	24	ANL 24	120
AWL 26	AWL 26 X	130	125	14	2	12	143	165	1.5	6	19	8.7	26	ANL 26	130
AWL 28	AWL 28 X	140	135	16	2	14	151	175	1.5	8	19	10.9	28	ANL 28	140
AWL 30	AWL 30 X	150	145	16	2	14	164	190	1.5	8	19	11.3	30	ANL 30	150
AWL 32	AWL 32 X	160	154	18	2.5	16	174	200	1.5	8	19	16.2	32	ANL 32	160
AWL 34	AWL 34 X	170	164	18	2.5	16	184	210	1.5	8	19	19	34	ANL 34	170
AWL 36	AWL 36 X	180	174	20	2.5	18	192	220	1.5	8	19	18	36	ANL 36	180
AWL 38	AWL 38 X	190	184	20	2.5	18	202	230	1.5	8	19	20.5	38	ANL 38	190
AWL 40	AWL 40 X	200	194	20	2.5	18	218	250	1.5	8	19	21.4	40	ANL 40	200

Note (1) Series AW is applicable to adapter sleeve Series A31 and A23. Series AWL is applicable to adapter sleeve Series A30.

Remark Lock-washers with straight tabs shall be used with adapter sleeves having narrow slits. For adapter sleeves having wide slits, either type of lock-washer may be used.



APPENDICES

Appendix Table 1	Conversion Table from SI (International Units) System	C 002
Appendix Table 2	N – kgf Force Conversion Table.....	C 004
Appendix Table 3	kg – lb Mass Conversion Table.....	C 005
Appendix Table 4	°C – °F Temperature Conversion Table.....	C 006
Appendix Table 5	Viscosity Conversion Table.....	C 007
Appendix Table 6	inch – mm Conversion Table	C 008
Appendix Table 7	Hardness Conversion Table.....	C 010
Appendix Table 8	Physical and Mechanical Properties of Materials	C 011
Appendix Table 9	Tolerances for Shaft Diameters.....	C 012
Appendix Table 10	Tolerances for Housing Bore Diameters.....	C 014
Appendix Table 11	Values of Standard Tolerance Grades IT.....	C 016
Appendix Table 12	Speed Factor f_n	C 018
Appendix Table 13	Fatigue Life Factor f_n and Fatigue Life $L - L_h$	C 019
Appendix Table 14	Index of Inch Design Tapered Roller Bearings.....	C 020

Appendices

**Appendix Table 1 Conversion Table from SI (International Units) System
Comparison of SI, CGS, and Engineering Units**

Units Unit System	Length	Mass	Time	Temp.	Acceleration	Force	Stress	Pressure	Energy	Power
SI	m	kg	s	K, °C	m/s ²	N	Pa	Pa	J	W
CGS System	cm	g	s	°C	Gal	dyn	dyn/cm ²	dyn/cm ²	erg	erg/s
Engineering Unit System	m	kgf · s ² /m	s	°C	m/s ²	kgf	kgf/m ²	kgf/m ²	kgf · m	kgf · m/s

Conversion Factors from SI Units

Parameter	SI Units		Units other than SI		Conversion Factors from SI Units
	Names of Units	Symbols	Name of Units	Symbols	
Angle	Radian	rad	Degree	°	180/π
			Minute	'	10 800/π
			Second	"	648 000/π
Length	Meter	m	Micron	μ	10 ⁶
			Angstrom	Å	10 ¹⁰
Area	Square meter	m ²	Are	a	10 ⁻²
			Hectare	ha	10 ⁻⁴
Volume	Cubic meter	m ³	Liter	l, L	10 ³
			Deciliter	dl, dL	10 ⁴
Time	Second	s	Minute	min	1/60
			Hour	h	1/3 600
			Day	d	1/86 400
Frequency	Hertz	Hz	Cycle	s ⁻¹	1
Speed of Rotation	Revolution per second	s ⁻¹	Revolution per minute	rpm	60
Speed	Meter per second	m/s	Kilometer per hour	km/h	3 600/1 000
			Knot	kn	3 600/1 852
Acceleration	Meter per second per second	m/s ²	Gal	Gal	10 ²
			g	G	1/9.806 65
Mass	Kilogram	kg	Ton	t	10 ⁻³
Force	Newton	N	Kilogram-force	kgf	1/9.806 65
			Ton-force	tf	1/ (9.806 65×10 ³)
			Dyne	dyn	10 ⁵
Torque or Moment	Newton · meter	N · m	Kilogram-force meter	kgf · m	1/9.806 65
Stress	Pascal	Pa (N/m ²)	Kilogram-force per square centimeter	kgf/cm ²	1/ (9.806 65×10 ⁴)
			Kilogram-force per square millimeter	kgf/mm ²	1/ (9.806 65×10 ⁶)

Prefixes Used In SI System

Multiples	Prefix	Symbols	Multiples	Prefix	Symbols
10^{18}	Exa	E	10^{-1}	Deci	d
10^{15}	Peta	P	10^{-2}	Centi	c
10^{12}	Tera	T	10^{-3}	Milli	m
10^9	Giga	G	10^{-6}	Micro	μ
10^6	Mega	M	10^{-9}	Nano	n
10^3	Kilo	k	10^{-12}	Pico	p
10^2	Hecto	h	10^{-15}	Femto	f
10	Deca	da	10^{-18}	Ato	a

Conversion Factors from SI Units (Continued)

Parameter	SI Units		Units other than SI		Conversion Factors from SI Units
	Names of Units	Symbols	Names of Units	Units	
Pressure	Pascal (Newton per square meter)	Pa (N/m ²)	Kilogram-force per square meter	kgf/m ²	1/9.806 65
			Water Column	mmH ₂ O	1/(9.806 65×10 ³)
			Mercury Column	mmHg	760/(1.013 25×10 ⁵)
			Torr	Torr	760/(1.013 25×10 ⁵)
			Bar	bar	10 ⁵
			Atmosphere	atm	1/(1.013 25×10 ⁵)
Energy	Joule (Newton · meter)	J (N · m)	Erg	erg	10 ⁷
			Calorie (International)	cal _{IT}	1/4.186 8
			Kilogram-force meter	kgf · m	1/9.806 65
			Kilowatt hour	kW · h	1/(3.6×10 ⁶)
			French horse power hour	PS · h	≈ 3.776 72×10 ⁻⁷
Work	Watt (Joule per second)	W (J/s)	Kilogram-force meter per second	kgf · m/s	1/9.806 65
			Kilocalorie per hour	kcal/h	1/1.163
			French horse power	PS	≈ 1/735.498 8
Viscosity, Viscosity Index	Pascal second Square meter per second	Pa · s m ² /s	Poise	P	10
			Stokes	St	10 ⁴
Kinematic Viscosity, Kinematic Viscosity Index			Centistokes	cSt	10 ⁶
Temperature	Kelvin, Degree celsius	K, °C	Degree	°C	(See note (1))
Electric Current, Magnetomotive Force	Ampere	A	Ampere	A	1
Voltage, Electromotive Force	Volt	V	(Watts per ampere)	(W/A)	1
Magnetic Field Strength	Ampere per meter	A/m	Oersted	Oe	4 π /10 ³
Magnetic Flux	Tesla	T	Gauss	Gs	10 ⁴
Density			Gamma	γ	10 ⁹
Electrical Resistance	Ohm	Ω	(Volts per ampere)	(V/A)	1

Note (1) The conversion from TK into $\theta^\circ\text{C}$ is $\theta = T - 273.15$ but for a temperature difference, it is $\Delta T = \Delta \theta$. However, ΔT and $\Delta \theta$ represent temperature differences measured using the Kelvin and Celsius scales respectively.

Remarks The names and symbols in () are equivalent to those directly above them or on their left.
Example of conversion $1\text{N} = 1/9.806\ 65\text{kgf}$

Appendices

Appendix Table 2 N - kgf Force Conversion Table

[Method of using this table] For example, to convert 10 N into kgf, read the figure in the right kgf column adjacent to the 10 in the center column in the 1st block. This means that 10 N is 1.0197 kgf. To convert 10 kgf into N, read the figure in the left N column of the same row, which indicates that the answer is 98.066 N.

$$1 \text{ N} = 0.1019716 \text{ kgf}$$

$$1 \text{ kgf} = 9.80665 \text{ N}$$

N		kgf
9.8066	1	0.1020
19.613	2	0.2039
29.420	3	0.3059
39.227	4	0.4079
49.033	5	0.5099
58.840	6	0.6118
68.647	7	0.7138
78.453	8	0.8158
88.260	9	0.9177
98.066	10	1.0197
107.87	11	1.1217
117.68	12	1.2237
127.49	13	1.3256
137.29	14	1.4276
147.10	15	1.5296
156.91	16	1.6315
166.71	17	1.7335
176.52	18	1.8355
186.33	19	1.9375
196.13	20	2.0394
205.94	21	2.1414
215.75	22	2.2434
225.55	23	2.3453
235.36	24	2.4473
245.17	25	2.5493
254.97	26	2.6513
264.78	27	2.7532
274.59	28	2.8552
284.39	29	2.9572
294.20	30	3.0591
304.01	31	3.1611
313.81	32	3.2631
323.62	33	3.3651

N		kgf
333.43	34	3.4670
343.23	35	3.5690
353.04	36	3.6710
362.85	37	3.7729
372.65	38	3.8749
382.46	39	3.9769
392.27	40	4.0789
402.07	41	4.1808
411.88	42	4.2828
421.69	43	4.3848
431.49	44	4.4868
441.30	45	4.5887
451.11	46	4.6907
460.91	47	4.7927
470.72	48	4.8946
480.53	49	4.9966
490.33	50	5.0986
500.14	51	5.2006
509.95	52	5.3025
519.75	53	5.4045
529.56	54	5.5065
539.37	55	5.6084
549.17	56	5.7104
558.98	57	5.8124
568.79	58	5.9144
578.59	59	6.0163
588.40	60	6.1183
598.21	61	6.2203
608.01	62	6.3222
617.82	63	6.4242
627.63	64	6.5262
637.43	65	6.6282
647.24	66	6.7301

N		kgf
657.05	67	6.8321
666.85	68	6.9341
676.66	69	7.0360
686.47	70	7.1380
696.27	71	7.2400
706.08	72	7.3420
715.89	73	7.4439
725.69	74	7.5459
735.50	75	7.6479
745.31	76	7.7498
755.11	77	7.8518
764.92	78	7.9538
774.73	79	8.0558
784.53	80	8.1577
794.34	81	8.2597
804.15	82	8.3617
813.95	83	8.4636
823.76	84	8.5656
833.57	85	8.6676
843.37	86	8.7696
853.18	87	8.8715
862.99	88	8.9735
872.79	89	9.0755
882.60	90	9.1774
892.41	91	9.2794
902.21	92	9.3814
912.02	93	9.4834
921.83	94	9.5853
931.63	95	9.6873
941.44	96	9.7893
951.25	97	9.8912
961.05	98	9.9932
970.86	99	10.095

Appendix Table 3 kg - lb Mass Conversion Table

[Method of using this table] For example, to convert 10 kg into lb, read the figure in the right lb column adjacent to the 10 in the center column in the 1st block. This means that 10 kg is 22.046 lb. To convert 10 lb into kg, read the figure in the left kg column of the same row, which indicates that the answer is 4.536 kg.

$$1 \text{ kg} = 2.2046226 \text{ lb}$$

$$1 \text{ lb} = 0.45359237 \text{ kg}$$

kg		lb
0.454	1	2.205
0.907	2	4.409
1.361	3	6.614
1.814	4	8.818
2.268	5	11.023
2.722	6	13.228
3.175	7	15.432
3.629	8	17.637
4.082	9	19.842
4.536	10	22.046
4.990	11	24.251
5.443	12	26.455
5.897	13	28.660
6.350	14	30.865
6.804	15	33.069
7.257	16	35.274
7.711	17	37.479
8.165	18	39.683
8.618	19	41.888
9.072	20	44.092
9.525	21	46.297
9.979	22	48.502
10.433	23	50.706
10.886	24	52.911
11.340	25	55.116
11.793	26	57.320
12.247	27	59.525
12.701	28	61.729
13.154	29	63.934
13.608	30	66.139
14.061	31	68.343
14.515	32	70.548
14.969	33	72.753

kg		lb
15.422	34	74.957
15.876	35	77.162
16.329	36	79.366
16.783	37	81.571
17.237	38	83.776
17.690	39	85.980
18.144	40	88.185
18.597	41	90.390
19.051	42	92.594
19.504	43	94.799
19.958	44	97.003
20.412	45	99.208
20.865	46	101.41
21.319	47	103.62
21.772	48	105.82
22.226	49	108.03
22.680	50	110.23
23.133	51	112.44
23.587	52	114.64
24.040	53	116.84
24.494	54	119.05
24.948	55	121.25
25.401	56	123.46
25.855	57	125.66
26.308	58	127.87
26.762	59	130.07
27.216	60	132.28
27.669	61	134.48
28.123	62	136.69
28.576	63	138.89
29.030	64	141.10
29.484	65	143.30
29.937	66	145.51

kg		lb
30.391	67	147.71
30.844	68	149.91
31.298	69	152.12
31.751	70	154.32
32.205	71	156.53
32.659	72	158.73
33.112	73	160.94
33.566	74	163.14
34.019	75	165.35
34.473	76	167.55
34.927	77	169.76
35.380	78	171.96
35.834	79	174.17
36.287	80	176.37
36.741	81	178.57
37.195	82	180.78
37.648	83	182.98
38.102	84	185.19
38.555	85	187.39
39.009	86	189.60
39.463	87	191.80
39.916	88	194.01
40.370	89	196.21
40.823	90	198.42
41.277	91	200.62
41.730	92	202.83
42.184	93	205.03
42.638	94	207.23
43.091	95	209.44
43.545	96	211.64
43.998	97	213.85
44.452	98	216.05
44.906	99	218.26

Appendices

Appendix Table 4 °C - °F Temperature Conversion Table

[Method of using this table] For example, to convert 38 °C into °F, read the figure in the right °F column adjacent to the 38 in the center column in the 2nd block. This means that 38 °C is 100.4 °F. To convert 38 °F into °C, read the figure in the left °C column of the same row, which indicates that the answer is 3.3 °C.

$$C = \frac{5}{9}(F-32)$$

$$F = 32 + \frac{9}{5}C$$

°C	°F		°C	°F		°C	°F		°C	°F	
-73.3	-100	-148.0	0.0	32	89.6	21.7	71	159.8	43.3	110	230
-62.2	-80	-112.0	0.6	33	91.4	22.2	72	161.6	46.1	115	239
-51.1	-60	-76.0	1.1	34	93.2	22.8	73	163.4	48.9	120	248
-40.0	-40	-40.0	1.7	35	95.0	23.3	74	165.2	51.7	125	257
-34.4	-30	-22.0	2.2	36	96.8	23.9	75	167.0	54.4	130	266
-28.9	-20	-4.0	2.8	37	98.6	24.4	76	168.8	57.2	135	275
-23.3	-10	14.0	3.3	38	100.4	25.0	77	170.6	60.0	140	284
-17.8	0	32.0	3.9	39	102.2	25.6	78	172.4	65.6	150	302
-17.2	1	33.8	4.4	40	104.0	26.1	79	174.2	71.1	160	320
-16.7	2	35.6	5.0	41	105.8	26.7	80	176.0	76.7	170	338
-16.1	3	37.4	5.6	42	107.6	27.2	81	177.8	82.2	180	356
-15.6	4	39.2	6.1	43	109.4	27.8	82	179.6	87.8	190	374
-15.0	5	41.0	6.7	44	111.2	28.3	83	181.4	93.3	200	392
-14.4	6	42.8	7.2	45	113.0	28.9	84	183.2	98.9	210	410
-13.9	7	44.6	7.8	46	114.8	29.4	85	185.0	104.4	220	428
-13.3	8	46.4	8.3	47	116.6	30.0	86	186.8	110.0	230	446
-12.8	9	48.2	8.9	48	118.4	30.6	87	188.6	115.6	240	464
-12.2	10	50.0	9.4	49	120.2	31.1	88	190.4	121.1	250	482
-11.7	11	51.8	10.0	50	122.0	31.7	89	192.2	148.9	300	572
-11.1	12	53.6	10.6	51	123.8	32.2	90	194.0	176.7	350	662
-10.6	13	55.4	11.1	52	125.6	32.8	91	195.8	204	400	752
-10.0	14	57.2	11.7	53	127.4	33.3	92	197.6	232	450	842
-9.4	15	59.0	12.2	54	129.2	33.9	93	199.4	260	500	932
-8.9	16	60.8	12.8	55	131.0	34.4	94	201.2	288	550	1022
-8.3	17	62.6	13.3	56	132.8	35.0	95	203.0	316	600	1112
-7.8	18	64.4	13.9	57	134.6	35.6	96	204.8	343	650	1202
-7.2	19	66.2	14.4	58	136.4	36.1	97	206.6	371	700	1292
-6.7	20	68.0	15.0	59	138.2	36.7	98	208.4	399	750	1382
-6.1	21	69.8	15.6	60	140.0	37.2	99	210.2	427	800	1472
-5.6	22	71.6	16.1	61	141.8	37.8	100	212.0	454	850	1562
-5.0	23	73.4	16.7	62	143.6	38.3	101	213.8	482	900	1652
-4.4	24	75.2	17.2	63	145.4	38.9	102	215.6	510	950	1742
-3.9	25	77.0	17.8	64	147.2	39.4	103	217.4	538	1000	1832
-3.3	26	78.8	18.3	65	149.0	40.0	104	219.2	593	1100	2012
-2.8	27	80.6	18.9	66	150.8	40.6	105	221.0	649	1200	2192
-2.2	28	82.4	19.4	67	152.6	41.1	106	222.8	704	1300	2372
-1.7	29	84.2	20.0	68	154.4	41.7	107	224.6	760	1400	2552
-1.1	30	86.0	20.6	69	156.2	42.2	108	226.4	816	1500	2732
-0.6	31	87.8	21.1	70	158.0	42.8	109	228.2	871	1600	2912

Appendix Table 5 Viscosity Conversion Table

Kinematic Viscosity mm ² /s	Saybolt Universal SUS (sec)		No.1 Type Redwood R (sec)		Engler E (degree)
	100 °F	210 °F	50 °C	100 °C	
2	32.6	32.8	30.8	31.2	1.14
3	36.0	36.3	33.3	33.7	1.22
4	39.1	39.4	35.9	36.5	1.31
5	42.3	42.6	38.5	39.1	1.40
6	45.5	45.8	41.1	41.7	1.48
7	48.7	49.0	43.7	44.3	1.56
8	52.0	52.4	46.3	47.0	1.65
9	55.4	55.8	49.1	50.0	1.75
10	58.8	59.2	52.1	52.9	1.84
11	62.3	62.7	55.1	56.0	1.93
12	65.9	66.4	58.2	59.1	2.02
13	69.6	70.1	61.4	62.3	2.12
14	73.4	73.9	64.7	65.6	2.22
15	77.2	77.7	68.0	69.1	2.32
16	81.1	81.7	71.5	72.6	2.43
17	85.1	85.7	75.0	76.1	2.54
18	89.2	89.8	78.6	79.7	2.64
19	93.3	94.0	82.1	83.6	2.76
20	97.5	98.2	85.8	87.4	2.87
21	102	102	89.5	91.3	2.98
22	106	107	93.3	95.1	3.10
23	110	111	97.1	98.9	3.22
24	115	115	101	103	3.34
25	119	120	105	107	3.46
26	123	124	109	111	3.58
27	128	129	112	115	3.70
28	132	133	116	119	3.82
29	137	138	120	123	3.95
30	141	142	124	127	4.07
31	145	146	128	131	4.20
32	150	150	132	135	4.32
33	154	155	136	139	4.45
34	159	160	140	143	4.57

Kinematic Viscosity mm ² /s	Saybolt Universal SUS (sec)		No.1 Type Redwood R (sec)		Engler E (degree)
	100 °F	210 °F	50 °C	100 °C	
35	163	164	144	147	4.70
36	168	170	148	151	4.83
37	172	173	153	155	4.96
38	177	178	156	159	5.08
39	181	183	160	164	5.21
40	186	187	164	168	5.34
41	190	192	168	172	5.47
42	195	196	172	176	5.59
43	199	201	176	180	5.72
44	204	205	180	185	5.85
45	208	210	184	189	5.98
46	213	215	188	193	6.11
47	218	219	193	197	6.24
48	222	224	197	202	6.37
49	227	228	201	206	6.50
50	231	233	205	210	6.63
55	254	256	225	231	7.24
60	277	279	245	252	7.90
65	300	302	266	273	8.55
70	323	326	286	294	9.21
75	346	349	306	315	9.89
80	371	373	326	336	10.5
85	394	397	347	357	11.2
90	417	420	367	378	11.8
95	440	443	387	399	12.5
100	464	467	408	420	13.2
120	556	560	490	504	15.8
140	649	653	571	588	18.4
160	742	747	653	672	21.1
180	834	840	734	757	23.7
200	927	933	816	841	26.3
250	1159	1167	1020	1051	32.9
300	1391	1400	1224	1241	39.5

Remark 1 mm²/s = 1 cSt

Appendices

Appendix Table 6 inch - mm Conversion Table

1" = 25.4mm

inch		0	1	2	3	4	5	6	7	8	9	10
Fraction	Decimal	mm										
0	0.000000	0.000	25.400	50.800	76.200	101.600	127.000	152.400	177.800	203.200	228.600	254.000
1/64	0.015625	0.397	25.797	51.197	76.597	101.997	127.397	152.797	178.197	203.597	228.997	254.397
1/32	0.031250	0.794	26.194	51.594	76.994	102.394	127.794	153.194	178.594	203.994	229.394	254.794
3/64	0.046875	1.191	26.591	51.991	77.391	102.791	128.191	153.591	178.991	204.391	229.791	255.191
1/16	0.062500	1.588	26.988	52.388	77.788	103.188	128.588	153.988	179.388	204.788	230.188	255.588
5/64	0.078125	1.984	27.384	52.784	78.184	103.584	128.984	154.384	179.784	205.184	230.584	255.984
3/32	0.093750	2.381	27.781	53.181	78.581	103.981	129.381	154.781	180.181	205.581	230.981	256.381
7/64	0.109375	2.778	28.178	53.578	78.978	104.378	129.778	155.178	180.578	205.978	231.378	256.778
1/8	0.125000	3.175	28.575	53.975	79.375	104.775	130.175	155.575	180.975	206.375	231.775	257.175
9/64	0.140625	3.572	28.972	54.372	79.772	105.172	130.572	155.972	181.372	206.772	232.172	257.572
5/32	0.156250	3.969	29.369	54.769	80.169	105.569	130.969	156.369	181.769	207.169	232.569	257.969
11/64	0.171875	4.366	29.766	55.166	80.566	105.966	131.366	156.766	182.166	207.566	232.966	258.366
3/16	0.187500	4.762	30.162	55.562	80.962	106.362	131.762	157.162	182.562	207.962	233.362	258.762
13/64	0.203125	5.159	30.559	55.959	81.359	106.759	132.159	157.559	182.959	208.359	233.759	259.159
7/32	0.218750	5.556	30.956	56.356	81.756	107.156	132.556	157.956	183.356	208.756	234.156	259.556
15/64	0.234375	5.953	31.353	56.753	82.153	107.553	132.953	158.353	183.753	209.153	234.553	259.953
1/4	0.250000	6.350	31.750	57.150	82.550	107.950	133.350	158.750	184.150	209.550	234.950	260.350
17/64	0.265625	6.747	32.147	57.547	82.947	108.347	133.747	159.147	184.547	209.947	235.347	260.747
9/32	0.281250	7.144	32.544	57.944	83.344	108.744	134.144	159.544	184.944	210.344	235.744	261.144
19/64	0.296875	7.541	32.941	58.341	83.741	109.141	134.541	159.941	185.341	210.741	236.141	261.541
5/16	0.312500	7.938	33.338	58.738	84.138	109.538	134.938	160.338	185.738	211.138	236.538	261.938
21/64	0.328125	8.334	33.734	59.134	84.534	109.934	135.334	160.734	186.134	211.534	236.934	262.334
11/32	0.343750	8.731	34.131	59.531	84.931	110.331	135.731	161.131	186.531	211.931	237.331	262.731
23/64	0.359375	9.128	34.528	59.928	85.328	110.728	136.128	161.528	186.928	212.328	237.728	263.128
3/8	0.375000	9.525	34.925	60.325	85.725	111.125	136.525	161.925	187.325	212.725	238.125	263.525
25/64	0.390625	9.922	35.322	60.722	86.122	111.522	136.922	162.322	187.722	213.122	238.522	263.922
13/32	0.406250	10.319	35.719	61.119	86.519	111.919	137.319	162.719	188.119	213.519	238.919	264.319
27/64	0.421875	10.716	36.116	61.516	86.916	112.316	137.716	163.116	188.516	213.916	239.316	264.716
7/16	0.437500	11.112	36.512	61.912	87.312	112.712	138.112	163.512	188.912	214.312	239.712	265.112
29/64	0.453125	11.509	36.909	62.309	87.709	113.109	138.509	163.909	189.309	214.709	240.109	265.509
15/32	0.468750	11.906	37.306	62.706	88.106	113.506	138.906	164.306	189.706	215.106	240.506	265.906
31/64	0.484375	12.303	37.703	63.103	88.503	113.903	139.303	164.703	190.103	215.503	240.903	266.303
1/2	0.500000	12.700	38.100	63.500	88.900	114.300	139.700	165.100	190.500	215.900	241.300	266.700
33/64	0.515625	13.097	38.497	63.897	89.297	114.697	140.097	165.497	190.897	216.297	241.697	267.097
17/32	0.531250	13.494	38.894	64.294	89.694	115.094	140.494	165.894	191.294	216.694	242.094	267.494
35/64	0.546875	13.891	39.291	64.691	90.091	115.491	140.891	166.291	191.691	217.091	242.491	267.891
9/16	0.562500	14.288	39.688	65.088	90.488	115.888	141.288	166.688	192.088	217.488	242.888	268.288
37/64	0.578125	14.684	40.084	65.484	90.884	116.284	141.684	167.084	192.484	217.884	243.284	268.684
19/32	0.593750	15.081	40.481	65.881	91.281	116.681	142.081	167.481	192.881	218.281	243.681	269.081
39/64	0.609375	15.478	40.878	66.278	91.678	117.078	142.478	167.878	193.278	218.678	244.078	269.478
5/8	0.625000	15.875	41.275	66.675	92.075	117.475	142.875	168.275	193.675	219.075	244.475	269.875
41/64	0.640625	16.272	41.672	67.072	92.472	117.872	143.272	168.672	194.072	219.472	244.872	270.272
21/32	0.656250	16.669	42.069	67.469	92.869	118.269	143.669	169.069	194.469	219.869	245.269	270.669
43/64	0.671875	17.066	42.466	67.866	93.266	118.666	144.066	169.466	194.866	220.266	245.666	271.066
11/16	0.687500	17.462	42.862	68.262	93.662	119.062	144.462	169.862	195.262	220.662	246.062	271.462
45/64	0.703125	17.859	43.259	68.659	94.059	119.459	144.859	170.259	195.659	221.059	246.459	271.859
23/32	0.718750	18.256	43.656	69.056	94.456	119.856	145.256	170.656	196.056	221.456	246.856	272.256
47/64	0.734375	18.653	44.053	69.453	94.853	120.253	145.653	171.053	196.453	221.853	247.253	272.653
3/4	0.750000	19.050	44.450	69.850	95.250	120.650	146.050	171.450	196.850	222.250	247.650	273.050
49/64	0.765625	19.447	44.847	70.247	95.647	121.047	146.447	171.847	197.247	222.647	248.047	273.447
25/32	0.781250	19.844	45.244	70.644	96.044	121.444	146.844	172.244	197.644	223.044	248.444	273.844
51/64	0.796875	20.241	45.641	71.041	96.441	121.841	147.241	172.641	198.041	223.441	248.841	274.241
13/16	0.812500	20.638	46.038	71.438	96.838	122.238	147.638	173.038	198.438	223.838	249.238	274.638
53/64	0.828125	21.034	46.434	71.834	97.234	122.634	148.034	173.434	198.834	224.234	249.634	275.034
27/32	0.843750	21.431	46.831	72.231	97.631	123.031	148.431	173.831	199.231	224.631	250.031	275.431
55/64	0.859375	21.828	47.228	72.628	98.028	123.428	148.828	174.228	199.628	225.028	250.428	275.828
7/8	0.875000	22.225	47.625	73.025	98.425	123.825	149.225	174.625	200.025	225.425	250.825	276.225
57/64	0.890625	22.622	48.022	73.422	98.822	124.222	149.622	175.022	200.422	225.822	251.222	276.622
29/32	0.906250	23.019	48.419	73.819	99.219	124.619	150.019	175.419	200.819	226.219	251.619	277.019
59/64	0.921875	23.416	48.816	74.216	99.616	125.016	150.416	175.816	201.216	226.616	252.016	277.416
15/16	0.937500	23.812	49.212	74.612	100.012	125.412	150.812	176.212	201.612	227.012	252.412	277.812
61/64	0.953125	24.209	49.609	75.009	100.409	125.809	151.209	176.609	202.009	227.409	252.809	278.209
31/32	0.968750	24.606	50.006	75.406	100.806	126.206	151.606	177.006	202.406	227.806	253.206	278.606
63/64	0.984375	25.003	50.403	75.803	101.203	126.603	152.003	177.403	202.803	228.203	253.603	279.003

1" = 25.4mm

inch		11	12	13	14	15	16	17	18	19	20
Fraction	Decimal	mm									
0	0.0000	279.400	304.800	330.200	355.600	381.000	406.400	431.800	457.200	482.600	508.000
1/16	0.0625	280.988	306.388	331.788	357.188	382.588	407.988	433.388	458.788	484.188	509.588
1/8	0.1250	282.575	307.975	333.375	358.775	384.175	409.575	434.975	460.375	485.775	511.175
3/16	0.1875	284.162	309.562	334.962	360.362	385.762	411.162	436.562	461.962	487.362	512.762
1/4	0.2500	285.750	311.150	336.550	361.950	387.350	412.750	438.150	463.550	488.950	514.350
5/16	0.3125	287.338	312.738	338.138	363.538	388.938	414.338	439.738	465.138	490.538	515.938
3/8	0.3750	288.925	314.325	339.725	365.125	390.525	415.925	441.325	466.725	492.125	517.525
7/16	0.4375	290.512	315.912	341.312	366.712	392.112	417.512	442.912	468.312	493.712	519.112
1/2	0.5000	292.100	317.500	342.900	368.300	393.700	419.100	444.500	469.900	495.300	520.700
9/16	0.5625	293.688	319.088	344.488	369.888	395.288	420.688	446.088	471.488	496.888	522.288
5/8	0.6250	295.275	320.675	346.075	371.475	396.875	422.275	447.675	473.075	498.475	523.875
11/16	0.6875	296.862	322.262	347.662	373.062	398.462	423.862	449.262	474.662	500.062	525.462
3/4	0.7500	298.450	323.850	349.250	374.650	400.050	425.450	450.850	476.250	501.650	527.050
13/16	0.8125	300.038	325.438	350.838	376.238	401.638	427.038	452.438	477.838	503.238	528.638
7/8	0.8750	301.625	327.025	352.425	377.825	403.225	428.625	454.025	479.425	504.825	530.225
15/16	0.9375	303.212	328.612	354.012	379.412	404.812	430.212	455.612	481.012	506.412	531.812

1" = 25.4mm

inch		21	22	23	24	25	26	27	28	29	30
Fraction	Decimal	mm									
0	0.0000	533.400	558.800	584.200	609.600	635.000	660.400	685.800	711.200	736.600	762.000
1/16	0.0625	534.988	560.388	585.788	611.188	636.588	661.988	687.388	712.788	738.188	763.588
1/8	0.1250	536.575	561.975	587.375	612.775	638.175	663.575	688.975	714.375	739.775	765.175
3/16	0.1875	538.162	563.562	588.962	614.362	639.762	665.162	690.562	715.962	741.362	766.762
1/4	0.2500	539.750	565.150	590.550	615.950	641.350	666.750	692.150	717.550	742.950	768.350
5/16	0.3125	541.338	566.738	592.138	617.538	642.938	668.338	693.738	719.138	744.538	769.938
3/8	0.3750	542.925	568.325	593.725	619.125	644.525	669.925	695.325	720.725	746.125	771.525
7/16	0.4375	544.512	569.912	595.312	620.712	646.112	671.512	696.912	722.312	747.712	773.112
1/2	0.5000	546.100	571.500	596.900	622.300	647.700	673.100	698.500	723.900	749.300	774.700
9/16	0.5625	547.688	573.088	598.488	623.888	649.288	674.688	700.088	725.488	750.888	776.288
5/8	0.6250	549.275	574.675	600.075	625.475	650.875	676.275	701.675	727.075	752.475	777.875
11/16	0.6875	550.862	576.262	601.662	627.062	652.462	677.862	703.262	728.662	754.062	779.462
3/4	0.7500	552.450	577.850	603.250	628.650	654.050	679.450	704.850	730.250	755.650	781.050
13/16	0.8125	554.038	579.438	604.838	630.238	655.638	681.038	706.438	731.838	757.238	782.638
7/8	0.8750	555.625	581.025	606.425	631.825	657.225	682.625	708.025	733.425	758.825	784.225
15/16	0.9375	557.212	582.612	608.012	633.412	658.812	684.212	709.612	735.012	760.412	785.812

1"=25.4mm

inch		31	32	33	34	35	36	37	38	39	40
Fraction	Decimal	mm									
0	0.0000	787.400	812.800	838.200	863.600	889.000	914.400	939.800	965.200	990.600	1016.000
1/16	0.0625	788.988	814.388	839.788	865.188	890.588	915.988	941.388	966.788	992.188	1017.588
1/8	0.1250	790.575	815.975	841.375	866.775	892.175	917.575	942.975	968.375	993.775	1019.175
3/16	0.1875	792.162	817.562	842.962	868.362	893.762	919.162	944.562	969.962	995.362	1020.762
1/4	0.2500	793.750	819.150	844.550	869.950	895.350	920.750	946.150	971.550	996.950	1022.350
5/16	0.3125	795.338	820.738	846.138	871.538	896.938	922.338	947.738	973.138	998.538	1023.938
3/8	0.3750	796.925	822.325	847.725	873.125	898.525	923.925	949.325	974.725	1000.125	1025.525
7/16	0.4375	798.512	823.912	849.312	874.712	900.112	925.512	950.912	976.312	1001.712	1027.112
1/2	0.5000	800.100	825.500	850.900	876.300	901.700	927.100	952.500	977.900	1003.300	1028.700
9/16	0.5625	801.688	827.088	852.488	877.888	903.288	928.688	954.088	979.488	1004.888	1030.288
5/8	0.6250	803.275	828.675	854.075	879.475	904.875	930.275	955.675	981.075	1006.475	1031.875
11/16	0.6875	804.862	830.262	855.662	881.062	906.462	931.862	957.262	982.662	1008.062	1033.462
3/4	0.7500	806.450	831.850	857.250	882.650	908.050	933.450	958.850	984.250	1009.650	1035.050
13/16	0.8125	808.038	833.438	858.838	884.238	909.638	935.038	960.438	985.838	1011.238	1036.638
7/8	0.8750	809.625	835.025	860.425	885.825	911.225	936.625	962.025	987.425	1012.825	1038.225
15/16	0.9375	811.212	836.612	862.012	887.412	912.812	938.212	963.621	989.012	1014.412	1039.812

Appendices

Appendix Table 7 Hardness Conversion Table (Reference)

Rockwell C Scale Hardness (1 471 N) {150 kgf}	Vickers Hardness	Brinell Hardness		Rockwell Hardness		Shore Hardness
		Standard Ball	Tungsten Carbide Ball	A Scale	B Scale	
				Load 588.4 N {60 kgf} Brale Indenter	Load 980.7 N {100 kgf} 1.588 mm (1/16 in) Ball	
68	940	-	-	85.6	-	97
67	900	-	-	85.0	-	95
66	865	-	-	84.5	-	92
65	832	-	739	83.9	-	91
64	800	-	722	83.4	-	88
63	772	-	705	82.8	-	87
62	746	-	688	82.3	-	85
61	720	-	670	81.8	-	83
60	697	-	654	81.2	-	81
59	674	-	634	80.7	-	80
58	653	-	615	80.1	-	78
57	633	-	595	79.6	-	76
56	613	-	577	79.0	-	75
55	595	-	560	78.5	-	74
54	577	-	543	78.0	-	72
53	560	-	525	77.4	-	71
52	544	500	512	76.8	-	69
51	528	487	496	76.3	-	68
50	513	475	481	75.9	-	67
49	498	464	469	75.2	-	66
48	484	451	455	74.7	-	64
47	471	442	443	74.1	-	63
46	458	432	432	73.6	-	62
45	446	421	421	73.1	-	60
44	434	409	409	72.5	-	58
43	423	400	400	72.0	-	57
42	412	390	390	71.5	-	56
41	402	381	381	70.9	-	55
40	392	371	371	70.4	-	54
39	382	362	362	69.9	-	52
38	372	353	353	69.4	-	51
37	363	344	344	68.9	-	50
36	354	336	336	68.4	(109.0)	49
35	345	327	327	67.9	(108.5)	48
34	336	319	319	67.4	(108.0)	47
33	327	311	311	66.8	(107.5)	46
32	318	301	301	66.3	(107.0)	44
31	310	294	294	65.8	(106.0)	43
30	302	286	286	65.3	(105.5)	42
29	294	279	279	64.7	(104.5)	41
28	286	271	271	64.3	(104.0)	41
27	279	264	264	63.8	(103.0)	40
26	272	258	258	63.3	(102.5)	38
25	266	253	253	62.8	(101.5)	38
24	260	247	247	62.4	(101.0)	37
23	254	243	243	62.0	100.0	36
22	248	237	237	61.5	99.0	35
21	243	231	231	61.0	98.5	35
20	238	226	226	60.5	97.8	34
(18)	230	219	219	-	96.7	33
(16)	222	212	212	-	95.5	32
(14)	213	203	203	-	93.9	31
(12)	204	194	194	-	92.3	29
(10)	196	187	187	-	90.7	28
(8)	188	179	179	-	89.5	27
(6)	180	171	171	-	87.1	26
(4)	173	165	165	-	85.5	25
(2)	166	158	158	-	83.5	24
(0)	160	152	152	-	81.7	24

Appendix Table 8 Physical and Mechanical Properties of Materials

Materials	Specific Gravity	Coefficient of Linear Expansion (0° to 100°C) (K ⁻¹)	Hardness (Brinell)	Young's modulus (MPa) {kgf/mm ² }	Tensile Strength (MPa) {kgf/mm ² }	Yield Point (MPa) {kgf/mm ² }	Elongation (%)
Bearing Steel (hardened)	7.83	12.5×10 ⁻⁶	650 to 740	208 000 {21 200}	1 570 to 1 960 {160 to 200}	-	-
Martensitic Stainless Steel SUS 440C	7.68	10.1×10 ⁻⁶	580	200 000 {20 400}	1 960 {200}	1 860 {190}	-
Mild Steel (C=0.12~0.20%)	7.86	11.6×10 ⁻⁶	100 to 130	206 000 {21 000}	373 to 471 {38 to 48}	216 to 294 {22 to 30}	24 to 36
Hard Steel (C=0.3~0.5%)	7.84	11.3×10 ⁻⁶	160 to 200	206 000 {21 000}	539 to 686 {55 to 70}	333 to 451 {34 to 46}	14 to 26
Austenitic Stainless Steel SUS 304	8.03	16.3×10 ⁻⁶	150	193 000 {19 700}	588 {60}	245 {25}	60
Cast Iron	Gray Iron FC200	7.3	10.4×10 ⁻⁶	98 100 {10 000}	More than 200 {20}	-	-
	Spheroidal graphite Iron FCD400	7.0	11.7×10 ⁻⁶	169 000 {17 200}	More than 400 {41}	-	More than 12
Aluminium	2.69	23.7×10 ⁻⁶	15 to 26	70 600 {7 200}	78 {8}	34 {3.5}	35
Zinc	7.14	31×10 ⁻⁶	30 to 60	92 200 {9 400}	147 {15}	-	30 to 40
Copper	8.93	16.2×10 ⁻⁶	50	123 000 {12 500}	196 {20}	69 {7}	15 to 20
Brass	(Annealed)	8.5	45	103 000 {10 500}	294 to 343 {30 to 35}	-	65 to 75
	(Machined)		85 to 130		363 to 539 {37 to 55}		15 to 50

Remark The hardness of hardened bearing steel and martensitic stainless steel is usually expressed using the Rockwell C Scale. For comparison, it is converted into Brinell hardness.

Appendices

Appendix Table 9 Tolerances for Shaft Diameters

Diameter Classification (mm)		Single Plane Mean B.D. Deviation (Normal) & dmp	d6	e6	f6	g5	g6	h5	h6	h7	h8	h9	h10	js5	js6
over	incl.														
3	6	0 - 8	- 30 - 38	- 20 - 28	-10 -18	- 4 - 9	- 4 -12	0 - 5	0 - 8	0 -12	0 -18	0 -30	0 -48	±2.5	±4
6	10	0 - 8	- 40 - 49	- 25 - 34	-13 -22	- 5 -11	- 5 -14	0 - 6	0 - 9	0 -15	0 -22	0 -36	0 -58	±3	±4.5
10	18	0 - 8	- 50 - 61	- 32 - 43	-16 -27	- 6 -14	- 6 -17	0 - 8	0 -11	0 -18	0 -27	0 -43	0 -70	±4	±5.5
18	30	0 -10	- 65 - 78	- 40 - 53	-20 -33	- 7 -16	- 7 -20	0 - 9	0 -13	0 -21	0 -33	0 -52	0 -84	±4.5	±6.5
30	50	0 -12	- 80 - 96	- 53 - 66	-25 -41	- 9 -20	- 9 -25	0 -11	0 -16	0 -25	0 -39	0 -62	0 -100	±5.5	±8
50	80	0 -15	-100 -119	- 60 - 79	-30 -49	-10 -23	-10 -29	0 -13	0 -19	0 -30	0 -46	0 -74	0 -120	±6.5	±9.5
80	120	0 -20	-120 -142	- 72 - 94	-36 -58	-12 -27	-12 -34	0 -15	0 -22	0 -35	0 -54	0 -87	0 -140	±7.5	±11
120	180	0 -25	-145 -170	- 85 -110	- 43 - 68	-14 -32	-14 -39	0 -18	0 -25	0 -40	0 -63	0 -100	0 -160	±9	±12.5
180	250	0 -30	-170 -199	-100 -129	- 50 - 79	-15 -35	-15 -44	0 -20	0 -29	0 -46	0 -72	0 -115	0 -185	±10	±14.5
250	315	0 -35	-190 -222	-110 -142	- 56 - 88	-17 -40	-17 -49	0 -23	0 -32	0 -52	0 -81	0 -130	0 -210	±11.5	±16
315	400	0 -40	-210 -246	-125 -161	- 62 - 98	-18 -43	-18 -54	0 -25	0 -36	0 -57	0 -89	0 -140	0 -230	±12.5	±18
400	500	0 -45	-230 -270	-135 -175	- 68 -108	-20 -47	-20 -60	0 -27	0 -40	0 -63	0 -97	0 -155	0 -250	±13.5	±20
500	630	0 -50	-260 -304	-145 -189	- 76 -120	-	- 22 - 66	-	0 -44	0 -70	0 -110	0 -175	0 -280	-	±22
630	800	0 -75	-290 -340	-160 -210	- 80 -130	-	- 24 - 74	-	0 -50	0 -80	0 -125	0 -200	0 -320	-	±25
800	1 000	0 -100	-320 -376	-170 -226	- 86 -142	-	- 26 - 82	-	0 -56	0 -90	0 -140	0 -230	0 -360	-	±28
1 000	1 250	0 -125	-350 -416	-195 -261	- 98 -164	-	- 28 - 94	-	0 -66	0 -105	0 -165	0 -260	0 -420	-	±33
1 250	1 600	0 -160	-390 -468	-220 -298	-110 -188	-	- 30 -108	-	0 -78	0 -125	0 -195	0 -310	0 -500	-	±39
1 600	2 000	0 -200	-430 -522	-240 -332	-120 -212	-	- 32 -124	-	0 -92	0 -150	0 -230	0 -370	0 -600	-	±46

Units : μm

j5	j6	j7	k5	k6	k7	m5	m6	n6	p6	r6	r7	Diameter Classification (mm)	
												over	incl.
+ 3	+ 6	+ 8	+ 6	+ 9	+ 13	+ 9	+ 12	+ 16	+ 20	+ 23	+ 27	3	6
- 2	- 2	- 4	+ 1	+ 1	+ 1	+ 4	+ 4	+ 8	+ 12	+ 15	+ 15		
+ 4	+ 7	+ 10	+ 7	+ 10	+ 16	+ 12	+ 15	+ 19	+ 24	+ 28	+ 34	6	10
- 2	- 2	- 5	+ 1	+ 1	+ 1	+ 6	+ 6	+ 10	+ 15	+ 19	+ 19		
+ 5	+ 8	+ 12	+ 9	+ 12	+ 19	+ 15	+ 18	+ 23	+ 29	+ 34	+ 41	10	18
- 3	- 3	- 6	+ 1	+ 1	+ 1	+ 7	+ 7	+ 12	+ 18	+ 23	+ 23		
+ 5	+ 9	+ 13	+ 11	+ 15	+ 23	+ 17	+ 21	+ 28	+ 35	+ 41	+ 49	18	30
- 4	- 4	- 8	+ 2	+ 2	+ 2	+ 8	+ 8	+ 15	+ 22	+ 28	+ 28		
+ 6	+ 11	+ 15	+ 13	+ 18	+ 27	+ 20	+ 25	+ 33	+ 42	+ 50	+ 59	30	50
- 5	- 5	- 10	+ 2	+ 2	+ 2	+ 9	+ 9	+ 17	+ 26	+ 34	+ 34		
+ 6	+ 12	+ 18	+ 15	+ 21	+ 32	+ 24	+ 30	+ 39	+ 51	+ 60	+ 71	50	65
- 7	- 7	- 12	+ 2	+ 2	+ 2	+ 11	+ 11	+ 20	+ 32	+ 41	+ 41		
+ 6	+ 13	+ 20	+ 18	+ 25	+ 38	+ 28	+ 35	+ 45	+ 59	+ 62	+ 73	80	100
- 9	- 9	- 15	+ 3	+ 3	+ 3	+ 13	+ 13	+ 23	+ 37	+ 43	+ 43		
+ 7	+ 14	+ 22	+ 21	+ 28	+ 43	+ 33	+ 40	+ 52	+ 68	+ 73	+ 86	100	120
- 11	- 11	- 18	+ 3	+ 3	+ 3	+ 15	+ 15	+ 27	+ 43	+ 51	+ 51		
+ 7	+ 16	+ 25	+ 24	+ 33	+ 50	+ 37	+ 46	+ 60	+ 79	+ 88	+ 103	120	140
- 13	- 13	- 21	+ 4	+ 4	+ 4	+ 17	+ 17	+ 31	+ 50	+ 63	+ 63		
+ 7	+ 14	+ 22	+ 21	+ 28	+ 43	+ 33	+ 40	+ 52	+ 68	+ 90	+ 105	140	160
- 11	- 11	- 18	+ 3	+ 3	+ 3	+ 15	+ 15	+ 27	+ 43	+ 65	+ 65		
+ 7	+ 16	+ 25	+ 24	+ 33	+ 50	+ 37	+ 46	+ 60	+ 79	+ 93	+ 108	160	180
- 13	- 13	- 21	+ 4	+ 4	+ 4	+ 17	+ 17	+ 31	+ 50	+ 68	+ 68		
+ 7	+ 16	+ 25	+ 24	+ 33	+ 50	+ 37	+ 46	+ 60	+ 79	+ 106	+ 123	180	200
- 13	- 13	- 21	+ 4	+ 4	+ 4	+ 17	+ 17	+ 31	+ 50	+ 77	+ 77		
+ 7	+ 16	+ 25	+ 24	+ 33	+ 50	+ 37	+ 46	+ 60	+ 79	+ 109	+ 126	200	225
- 13	- 13	- 21	+ 4	+ 4	+ 4	+ 17	+ 17	+ 31	+ 50	+ 80	+ 80		
+ 7	+ 16	+ 25	+ 24	+ 33	+ 50	+ 37	+ 46	+ 60	+ 79	+ 113	+ 130	225	250
- 13	- 13	- 21	+ 4	+ 4	+ 4	+ 17	+ 17	+ 31	+ 50	+ 84	+ 84		
+ 7	+ 16	+ 25	+ 24	+ 33	+ 50	+ 37	+ 46	+ 60	+ 79	+ 126	+ 146	250	280
- 13	- 13	- 21	+ 4	+ 4	+ 4	+ 17	+ 17	+ 31	+ 50	+ 94	+ 94		
+ 7	+ 16	+ 25	+ 24	+ 33	+ 50	+ 37	+ 46	+ 60	+ 79	+ 130	+ 150	280	315
- 13	- 13	- 21	+ 4	+ 4	+ 4	+ 17	+ 17	+ 31	+ 50	+ 98	+ 98		
+ 7	+ 16	+ 25	+ 24	+ 33	+ 50	+ 37	+ 46	+ 60	+ 79	+ 144	+ 165	315	355
- 13	- 13	- 21	+ 4	+ 4	+ 4	+ 17	+ 17	+ 31	+ 50	+ 108	+ 108		
+ 7	+ 16	+ 25	+ 24	+ 33	+ 50	+ 37	+ 46	+ 60	+ 79	+ 150	+ 171	355	400
- 13	- 13	- 21	+ 4	+ 4	+ 4	+ 17	+ 17	+ 31	+ 50	+ 114	+ 114		
+ 7	+ 16	+ 25	+ 24	+ 33	+ 50	+ 37	+ 46	+ 60	+ 79	+ 166	+ 189	400	450
- 13	- 13	- 21	+ 4	+ 4	+ 4	+ 17	+ 17	+ 31	+ 50	+ 126	+ 126		
+ 7	+ 16	+ 25	+ 24	+ 33	+ 50	+ 37	+ 46	+ 60	+ 79	+ 172	+ 195	450	500
- 13	- 13	- 21	+ 4	+ 4	+ 4	+ 17	+ 17	+ 31	+ 50	+ 132	+ 132		
-	-	-	-	+44	+ 70	-	+ 70	+ 88	+ 122	+ 194	+ 220	500	560
-	-	-	-	0	0	-	+ 26	+ 44	+ 78	+ 150	+ 150		
-	-	-	-	+50	+ 80	-	+ 80	+ 100	+ 138	+ 199	+ 225	560	630
-	-	-	-	0	0	-	+ 30	+ 50	+ 88	+ 155	+ 155		
-	-	-	-	+56	+ 90	-	+ 90	+ 112	+ 156	+ 225	+ 255	630	710
-	-	-	-	0	0	-	+ 34	+ 56	+ 100	+ 175	+ 175		
-	-	-	-	+66	+ 105	-	+ 106	+ 132	+ 186	+ 235	+ 265	710	800
-	-	-	-	0	0	-	+ 40	+ 66	+ 120	+ 185	+ 185		
-	-	-	-	+78	+ 125	-	+ 126	+ 156	+ 218	+ 266	+ 300	800	900
-	-	-	-	0	0	-	+ 48	+ 78	+ 140	+ 210	+ 210		
-	-	-	-	+92	+ 150	-	+ 150	+ 184	+ 262	+ 276	+ 310	900	1 000
-	-	-	-	0	0	-	+ 58	+ 92	+ 170	+ 220	+ 220		
-	-	-	-	+92	+ 150	-	+ 150	+ 184	+ 262	+ 316	+ 355	1 000	1 120
-	-	-	-	0	0	-	+ 58	+ 92	+ 170	+ 250	+ 250		
-	-	-	-	+92	+ 150	-	+ 150	+ 184	+ 262	+ 326	+ 365	1 120	1 250
-	-	-	-	0	0	-	+ 58	+ 92	+ 170	+ 260	+ 260		
-	-	-	-	+92	+ 150	-	+ 150	+ 184	+ 262	+ 378	+ 425	1 250	1 400
-	-	-	-	0	0	-	+ 58	+ 92	+ 170	+ 300	+ 300		
-	-	-	-	+92	+ 150	-	+ 150	+ 184	+ 262	+ 408	+ 455	1 400	1 600
-	-	-	-	0	0	-	+ 58	+ 92	+ 170	+ 330	+ 330		
-	-	-	-	+92	+ 150	-	+ 150	+ 184	+ 262	+ 462	+ 520	1 600	1 800
-	-	-	-	0	0	-	+ 58	+ 92	+ 170	+ 370	+ 370		
-	-	-	-	+92	+ 150	-	+ 150	+ 184	+ 262	+ 492	+ 550	1 800	2 000
-	-	-	-	0	0	-	+ 58	+ 92	+ 170	+ 400	+ 400		

Appendices

Appendix Table 10 Tolerances for Housing Bore Diameters

Diameter Classification (mm)		Single Plane Mean B.D. Deviation (Normal) & Dmp	E6	F6	F7	G6	G7	H6	H7	H8	J6	J7	JS6	JS7
over	incl.													
10	18	0 - 8	+ 43 + 32	+ 27 + 16	+ 34 + 16	+ 17 + 6	+ 24 + 6	+ 11 0	+ 18 0	+ 27 0	+ 6 - 5	+10 - 8	±5.5	±9
18	30	0 - 9	+ 53 + 40	+ 33 + 20	+ 41 + 20	+ 20 + 7	+ 28 + 7	+ 13 0	+ 21 0	+ 33 0	+ 8 - 5	+12 - 9	±6.5	±10.5
30	50	0 - 11	+ 66 + 50	+ 41 + 25	+ 50 + 25	+ 25 + 9	+ 34 + 9	+ 16 0	+ 25 0	+ 39 0	+10 - 6	+14 -11	±8	±12.5
50	80	0 - 13	+ 79 + 60	+ 49 + 30	+ 60 + 30	+ 29 + 10	+ 40 + 10	+ 19 0	+ 30 0	+ 46 0	+13 - 6	+18 -12	±9.5	±15
80	120	0 - 15	+ 94 + 72	+ 58 + 36	+ 71 + 36	+ 34 + 12	+ 47 + 12	+ 22 0	+ 35 0	+ 54 0	+16 - 6	+22 -13	±11	±17.5
120	150	0 - 18	+110 + 85	+ 68 + 43	+ 83 + 43	+ 39 + 14	+ 54 + 14	+ 25 0	+ 40 0	+ 63 0	+18 - 7	+26 -14	±12.5	±20
150	180	0 - 25												
180	250	0 - 30	+129 +100	+ 79 + 50	+ 96 + 50	+ 44 + 15	+ 61 + 15	+ 29 0	+ 46 0	+ 72 0	+22 - 7	+30 -16	±14.5	±23
250	315	0 - 35	+142 +110	+ 88 + 56	+108 + 56	+ 49 + 17	+ 69 + 17	+ 32 0	+ 52 0	+ 81 0	+25 - 7	+36 -16	±16	±26
315	400	0 - 40	+161 +125	+ 98 + 62	+119 + 62	+ 54 + 18	+ 75 + 18	+ 36 0	+ 57 0	+ 89 0	+29 - 7	+39 -18	±18	±28.5
400	500	0 - 45	+175 +135	+108 + 68	+131 + 68	+ 60 + 20	+ 83 + 20	+ 40 0	+ 63 0	+ 97 0	+33 - 7	+43 -20	±20	±31.5
500	630	0 - 50	+189 +145	+120 + 76	+146 + 76	+ 66 + 22	+ 92 + 22	+ 44 0	+ 70 0	+110 0	-	-	±22	±35
630	800	0 - 75	+210 +160	+130 + 80	+160 + 80	+ 74 + 24	+104 + 24	+ 50 0	+ 80 0	+125 0	-	-	±25	±40
800	1 000	0 -100	+226 +170	+142 + 86	+176 + 86	+ 82 + 26	+116 + 26	+ 56 0	+ 90 0	+140 0	-	-	±28	±45
1 000	1 250	0 -125	+261 +195	+164 + 98	+203 + 98	+ 94 + 28	+133 +28	+ 66 0	+105 0	+165 0	-	-	±33	±52.5
1 250	1 600	0 -160	+298 +220	+188 +110	+235 +110	+108 + 30	+155 + 30	+ 78 0	+125 0	+195 0	-	-	±39	±62.5
1 600	2 000	0 -200	+332 +240	+212 +120	+270 +120	+124 + 32	+182 + 32	+ 92 0	+150 0	+230 0	-	-	±46	±75
2 000	2 500	0 -250	+370 +260	+240 +130	+305 +130	+144 + 34	+209 + 34	+110 0	+175 0	+280 0	-	-	±55	±87.5

Units : μm

K5	K6	K7	M5	M6	M7	N5	N6	N7	P6	P7	Diameter Classification (mm)	
											over	incl.
+ 2 - 6	+ 2 - 9	+ 6 - 12	- 4 -12	- 4 - 15	0 - 18	- 9 -17	- 9 - 20	- 5 - 23	- 15 - 26	- 11 - 29	10	18
+ 1 - 8	+ 2 - 11	+ 6 - 15	- 5 -14	- 4 - 17	0 - 21	-12 -21	- 11 - 24	- 7 - 28	- 18 - 31	-14 - 35	18	30
+ 2 - 9	+ 3 - 13	+ 7 - 18	- 5 -16	- 4 - 20	0 - 25	-13 -24	- 12 - 28	- 8 - 33	- 21 - 37	- 17 - 42	30	50
+ 3 -10	+ 4 - 15	+ 9 - 21	- 6 -19	- 5 - 24	0 -30	-15 -28	- 14 - 33	- 9 - 39	- 26 - 45	- 21 - 51	50	80
+ 2 -13	+ 4 - 18	+ 10 - 25	- 8 -23	- 6 - 28	0 - 35	-18 -33	- 16 - 38	- 10 - 45	- 30 - 52	- 24 - 59	80	120
+ 3 -15	+ 4 - 21	+ 12 - 28	- 9 -27	- 8 - 33	0 - 40	-21 -39	- 20 - 45	- 12 - 52	- 36 - 61	- 28 - 68	120	180
+ 2 -18	+ 5 - 24	+ 13 - 33	-11 -31	- 8 - 37	0 - 46	-25 -45	- 22 - 51	- 14 - 60	- 41 - 70	- 33 - 79	180	250
+ 3 -20	+ 5 - 27	+ 16 - 36	-13 -36	- 9 - 41	0 - 52	-27 -50	- 25 - 57	- 14 - 66	- 47 - 79	- 36 - 88	250	315
+ 3 -22	+ 7 - 29	+ 17 - 40	-14 -39	- 10 - 46	0 - 57	-30 -55	- 26 - 62	- 16 - 73	- 51 - 87	- 41 - 98	315	400
+ 2 -25	+ 8 - 32	+ 18 - 45	-16 -43	- 10 - 50	0 - 63	-33 -60	- 27 - 67	- 17 - 80	- 55 - 95	- 45 -108	400	500
-	0 - 44	0 - 70	-	- 26 - 70	- 26 - 96	-	- 44 - 88	- 44 -114	- 78 -122	- 78 -148	500	630
-	0 - 50	0 - 80	-	- 30 - 80	- 30 -110	-	- 50 -100	- 50 -130	- 88 -138	- 88 -168	630	800
-	0 - 56	0 - 90	-	- 34 - 90	- 34 -124	-	- 56 -112	- 56 -146	-100 -156	-100 -190	800	1 000
-	0 - 66	0 -105	-	- 40 -106	- 40 -145	-	- 66 -132	- 66 -171	-120 -186	-120 -225	1 000	1 250
-	0 - 78	0 -125	-	- 48 -126	- 48 -173	-	- 78 -156	- 78 -203	-140 -218	-140 -265	1 250	1 600
-	0 - 92	0 -150	-	- 58 -150	- 58 -208	-	- 92 -184	- 92 -242	-170 -262	-170 -320	1 600	2 000
-	0 -110	0 -175	-	- 68 -178	- 68 -243	-	-110 -220	-110 -285	-195 -305	-195 -370	2 000	2 500

Appendices

Appendix Table 11 Values of Standard Tolerance Grades IT

Basic Size (mm)		Standard Grades										
		IT1	IT2	IT3	IT4	IT5	IT6	IT7	IT8	IT9	IT10	IT11
over	incl.	Tolerances (µm)										
-	3	0.8	1.2	2	3	4	6	10	14	25	40	60
3	6	1	1.5	2.5	4	5	8	12	18	30	48	75
6	10	1	1.5	2.5	4	6	9	15	22	36	58	90
10	18	1.2	2	3	5	8	11	18	27	43	70	110
18	30	1.5	2.5	4	6	9	13	21	33	52	84	130
30	50	1.5	2.5	4	7	11	16	25	39	62	100	160
50	80	2	3	5	8	13	19	30	46	74	120	190
80	120	2.5	4	6	10	15	22	35	54	87	140	220
120	180	3.5	5	8	12	18	25	40	63	100	160	250
180	250	4.5	7	10	14	20	29	46	72	115	185	290
250	315	6	8	12	16	23	32	52	81	130	210	320
315	400	7	9	13	18	25	36	57	89	140	230	360
400	500	8	10	15	20	27	40	63	97	155	250	400
500	630	9	11	16	22	32	44	70	110	175	280	440
630	800	10	13	18	25	36	50	80	125	200	320	500
800	1 000	11	15	21	28	40	56	90	140	230	360	560
1 000	1 250	13	18	24	33	47	66	105	165	260	420	660
1 250	1 600	15	21	29	39	55	78	125	195	310	500	780
1 600	2 000	18	25	35	46	65	92	150	230	370	600	920
2 000	2 500	22	30	41	55	78	110	175	280	440	700	1 100
2 500	3 150	26	36	50	68	96	135	210	330	540	860	1 350

- Remarks**
- Standard tolerance grades IT14 to IT18 shall not be used for basic sizes less than or equal to 1 mm.
 - Values for standard tolerance grades IT1 to IT5 for basic sizes over 500 mm are included for experimental use.

Standard Grades							Basic Size (mm)	
IT12	IT13	IT14	IT15	IT16	IT17	IT18		
Tolerances (mm)							over	incl.
0.10	0.14	0.25	0.40	0.60	1.00	1.40	-	3
0.12	0.18	0.30	0.48	0.75	1.20	1.80	3	6
0.15	0.22	0.36	0.58	0.90	1.50	2.20	6	10
0.18	0.27	0.43	0.70	1.10	1.80	2.70	10	18
0.21	0.33	0.52	0.84	1.30	2.10	3.30	18	30
0.25	0.39	0.62	1.00	1.60	2.50	3.90	30	50
0.30	0.46	0.74	1.20	1.90	3.00	4.60	50	80
0.35	0.54	0.87	1.40	2.20	3.50	5.40	80	120
0.40	0.63	1.00	1.60	2.50	4.00	6.30	120	180
0.46	0.72	1.15	1.85	2.90	4.60	7.20	180	250
0.52	0.81	1.30	2.10	3.20	5.20	8.10	250	315
0.57	0.89	1.40	2.30	3.60	5.70	8.90	315	400
0.63	0.97	1.55	2.50	4.00	6.30	9.70	400	500
0.70	1.10	1.75	2.80	4.40	7.00	11.00	500	630
0.80	1.25	2.00	3.20	5.00	8.00	12.50	630	800
0.90	1.40	2.30	3.60	5.60	9.00	14.00	800	1 000
1.05	1.65	2.60	4.20	6.60	10.50	16.50	1 000	1 250
1.25	1.95	3.10	5.00	7.80	12.50	19.50	1 250	1 600
1.50	2.30	3.70	6.00	9.20	15.00	23.00	1 600	2 000
1.75	2.80	4.40	7.00	11.00	17.50	28.00	2 000	2 500
2.10	3.30	5.40	8.60	13.50	21.00	33.00	2 500	3 150

Appendices

Appendix Table 12 Speed Factor f_n

Ball Bearings $f_n = (0.03 n)^{-1/3}$
 Roller Bearings $f_n = (0.03 n)^{-3/10}$

Speed n (min ⁻¹)	Speed Factor f_n		Speed n (min ⁻¹)	Speed Factor f_n		Speed n (min ⁻¹)	Speed Factor f_n	
	Ball Bearings	Roller Bearings		Ball Bearings	Roller Bearings		Ball Bearings	Roller Bearings
10	1.49	1.44	180	0.570	0.603	3 000	0.223	0.259
11	1.45	1.39	190	0.560	0.593	3 200	0.218	0.254
12	1.41	1.36	200	0.550	0.584	3 400	0.214	0.250
13	1.37	1.33	220	0.533	0.568	3 600	0.210	0.245
14	1.34	1.30	240	0.518	0.553	3 800	0.206	0.242
15	1.30	1.27	260	0.504	0.540	4 000	0.203	0.238
16	1.28	1.25	280	0.492	0.528	4 200	0.199	0.234
17	1.25	1.22	300	0.481	0.517	4 400	0.196	0.231
18	1.23	1.20	320	0.471	0.507	4 600	0.194	0.228
19	1.21	1.18	340	0.461	0.498	4 800	0.191	0.225
20	1.19	1.17	360	0.452	0.490	5 000	0.188	0.222
21	1.17	1.15	380	0.444	0.482	5 200	0.186	0.220
22	1.15	1.13	400	0.437	0.475	5 400	0.183	0.217
23	1.13	1.12	420	0.430	0.468	5 600	0.181	0.215
24	1.12	1.10	440	0.423	0.461	5 800	0.179	0.213
25	1.10	1.09	460	0.417	0.455	6 000	0.177	0.211
26	1.09	1.08	480	0.411	0.449	6 200	0.175	0.209
27	1.07	1.07	500	0.405	0.444	6 400	0.173	0.207
28	1.06	1.05	550	0.393	0.431	6 600	0.172	0.205
29	1.05	1.04	600	0.382	0.420	6 800	0.170	0.203
30	1.04	1.03	650	0.372	0.410	7 000	0.168	0.201
31	1.02	1.02	700	0.362	0.401	7 200	0.167	0.199
32	1.01	1.01	750	0.354	0.393	7 400	0.165	0.198
33.3	1.00	1.00	800	0.347	0.385	7 600	0.164	0.196
34	0.993	0.994	850	0.340	0.378	7 800	0.162	0.195
36	0.975	0.977	900	0.333	0.372	8 000	0.161	0.193
38	0.957	0.961	950	0.327	0.366	8 500	0.158	0.190
40	0.941	0.947	1 000	0.322	0.360	9 000	0.155	0.186
42	0.926	0.933	1 050	0.317	0.355	9 500	0.152	0.183
44	0.912	0.920	1 100	0.312	0.350	10 000	0.149	0.181
46	0.898	0.908	1 150	0.307	0.346	11 000	0.145	0.176
48	0.886	0.896	1 200	0.303	0.341	12 000	0.141	0.171
50	0.874	0.885	1 250	0.299	0.337	13 000	0.137	0.167
55	0.846	0.861	1 300	0.295	0.333	14 000	0.134	0.163
60	0.822	0.838	1 400	0.288	0.326	15 000	0.130	0.160
65	0.800	0.818	1 500	0.281	0.319	16 000	0.128	0.157
70	0.781	0.800	1 600	0.275	0.313	17 000	0.125	0.154
75	0.763	0.784	1 700	0.270	0.307	18 000	0.123	0.151
80	0.747	0.769	1 800	0.265	0.302	19 000	0.121	0.149
85	0.732	0.755	1 900	0.260	0.297	20 000	0.119	0.147
90	0.718	0.742	2 000	0.255	0.293	22 000	0.115	0.143
95	0.705	0.730	2 100	0.251	0.289	24 000	0.112	0.139
100	0.693	0.719	2 200	0.247	0.285	26 000	0.109	0.136
110	0.672	0.699	2 300	0.244	0.281	28 000	0.106	0.133
120	0.652	0.681	2 400	0.240	0.277	30 000	0.104	0.130
130	0.635	0.665	2 500	0.237	0.274	32 000	0.101	0.127
140	0.620	0.650	2 600	0.234	0.271	34 000	0.099	0.125
150	0.606	0.637	2 700	0.231	0.268	36 000	0.097	0.123
160	0.593	0.625	2 800	0.228	0.265	38 000	0.096	0.121
170	0.581	0.613	2 900	0.226	0.262	40 000	0.094	0.119

Appendix Table 13 Fatigue Life Factor f_h and Fatigue Life $L \cdot L_h$

Ball Bearings $L = (C/P)^3$ $L_h = 500 f_h^3$

Roller Bearings $L = (C/P)^{10/3}$ $L_h = 500 f_h^{10/3}$

C/P or f_h	Ball Bearing Life		Roller Bearing Life	
	L (10 ⁶ rev)	L_h (h)	L (10 ⁶ rev)	L_h (h)
0.70	0.34	172	0.30	152
0.75	0.42	211	0.38	192
0.80	0.51	256	0.48	238
0.85	0.61	307	0.58	291
0.90	0.73	365	0.70	352
0.95	0.86	429	0.84	421
1.00	1.00	500	1.00	500
1.05	1.16	579	1.18	588
1.10	1.33	665	1.37	687
1.15	1.52	760	1.59	797
1.20	1.73	864	1.84	918
1.25	1.95	977	2.10	1 050
1.30	2.20	1 100	2.40	1 200
1.35	2.46	1 230	2.72	1 360
1.40	2.74	1 370	3.07	1 530
1.45	3.05	1 520	3.45	1 730
1.50	3.38	1 690	3.86	1 930
1.55	3.72	1 860	4.31	2 150
1.60	4.10	2 050	4.79	2 400
1.65	4.49	2 250	5.31	2 650
1.70	4.91	2 460	5.86	2 930
1.75	5.36	2 680	6.46	3 230
1.80	5.83	2 920	7.09	3 550
1.85	6.33	3 170	7.77	3 890
1.90	6.86	3 430	8.50	4 250
1.95	7.41	3 710	9.26	4 630
2.00	8.00	4 000	10.1	5 040
2.05	8.62	4 310	10.9	5 470
2.10	9.26	4 630	11.9	5 930
2.15	9.94	4 970	12.8	6 410
2.20	10.6	5 320	13.8	6 920
2.25	11.4	5 700	14.9	7 460
2.30	12.2	6 080	16.1	8 030
2.35	13.0	6 490	17.3	8 630
2.40	13.8	6 910	18.5	9 250
2.45	14.7	7 350	19.8	9 910
2.50	15.6	7 810	21.2	10 600
2.55	16.6	8 290	22.7	11 300
2.60	17.6	8 790	24.2	12 100
2.65	18.6	9 300	25.8	12 900
2.70	19.7	9 840	27.4	13 700
2.75	20.8	10 400	29.1	14 600
2.80	22.0	11 000	30.9	15 500
2.85	23.1	11 600	32.8	16 400
2.90	24.4	12 200	34.8	17 400
2.95	25.7	12 800	36.8	18 400
3.00	27.0	13 500	38.9	19 500
3.05	28.4	14 200	41.1	20 600
3.10	29.8	14 900	43.4	21 700
3.15	31.3	15 600	45.8	22 900
3.20	32.8	16 400	48.3	24 100
3.25	34.3	17 200	50.8	25 400
3.30	35.9	18 000	53.5	26 800
3.35	37.6	18 800	56.3	28 100
3.40	39.3	19 700	59.1	29 600

C/P or f_h	Ball Bearing Life		Roller Bearing Life	
	L (10 ⁶ rev)	L_h (h)	L (10 ⁶ rev)	L_h (h)
3.45	41.1	20 500	62.0	31 000
3.50	42.9	21 400	65.1	32 500
3.55	44.7	22 400	68.2	34 100
3.60	46.7	23 300	71.5	35 800
3.65	48.6	24 300	74.9	37 400
3.70	50.7	25 300	78.3	39 200
3.75	52.7	26 400	81.9	41 000
3.80	54.9	27 400	85.6	42 800
3.85	57.1	28 500	89.4	44 700
3.90	59.3	29 700	93.4	46 700
3.95	61.6	30 800	97.4	48 700
4.00	64.0	32 000	102	50 800
4.05	66.4	33 200	106	52 900
4.10	68.9	34 500	110	55 200
4.15	71.5	35 700	115	57 400
4.20	74.1	37 000	120	59 800
4.25	76.8	38 400	124	62 200
4.30	79.5	39 800	129	64 600
4.35	82.3	41 200	134	67 200
4.40	85.2	42 600	140	69 800
4.45	88.1	44 100	145	72 500
4.50	91.1	45 600	150	75 200
4.55	94.2	47 100	156	78 000
4.60	97.3	48 700	162	80 900
4.65	101	50 300	168	83 900
4.70	104	51 900	174	87 000
4.75	107	53 600	180	90 100
4.80	111	55 300	187	93 300
4.85	114	57 000	193	96 600
4.90	118	58 800	200	99 900
4.95	121	60 600	207	103 000
5.00	125	62 500	214	107 000
5.10	133	66 300	228	114 000
5.20	141	70 300	244	122 000
5.30	149	74 400	260	130 000
5.40	157	78 700	276	138 000
5.50	166	83 200	294	147 000
5.60	176	87 800	312	156 000
5.70	185	92 600	331	165 000
5.80	195	97 600	351	175 000
5.90	205	103 000	371	186 000
6.00	216	108 000	392	196 000
6.50	275	137 000	513	256 000
7.00	343	172 000	656	328 000
7.50	422	211 000	826	413 000
8.00	512	256 000	1 020	512 000
8.50	614	307 000	1 250	627 000
9.00	729	365 000	1 520	758 000
9.50	857	429 000	1 820	908 000
10.0	1 000	-	2 150	-
11.0	1 330	-	2 960	-
12.0	1 730	-	3 960	-
13.0	2 200	-	5 170	-
14.0	2 740	-	6 610	-
15.0	3 380	-	8 320	-

Appendices

Appendix Table 14 Index of Inch Design Tapered Roller Bearings

Bearing No. CONE, CUP	Nominal Dimension (mm) d:CONE (Bore Dia.) D:CUP (Outside Dia.)	Pages	Bearing No. CONE, CUP	Nominal Dimension (mm) d:CONE (Bore Dia.) D:CUP (Outside Dia.)	Pages
332	D 80.000	B232, B236, B238	497	d 85.725	B254
336	d 41.275	B238	498	d 84.138	B254
342	d 41.275	B238	522	D 101.600	B240, B242
342 S	d 42.875	B238	528	d 47.625	B240
344	d 40.000	B236	529	d 50.800	B242
344 A	d 40.000	B236	529 X	d 50.800	B242
346	d 31.750	B232	532 X	D 107.950	B244
354 A	D 85.000	B240	539	d 53.975	B244
359 S	d 46.038	B240	552 A	D 123.825	B244, B246, B248
362 A	D 88.900	B240, B242	553 X	D 122.238	B246, B248
366	d 50.000	B242	555 S	d 57.150	B244
368	d 50.800	B242	557 S	d 53.975	B244
368 A	d 50.800	B242	558	d 60.325	B246
369 A	d 47.625	B240	559	d 63.500	B246
372	D 100.000	B242	560	d 66.675	B248
374	D 93.264	B240	560 S	d 68.262	B248
376	d 45.000	B240	563	D 127.000	B246, B248, B250
377	d 52.388	B242	563 X	D 127.000	B248
382	D 98.425	B244	565	d 63.500	B246
382 A	D 96.838	B244	566	d 69.850	B248
382 S	D 96.838	B244	567	d 73.025	B250
385	d 55.000	B244	567 A	d 71.438	B250
387	d 57.150	B244	567 S	d 71.438	B250
387A	d 57.150	B244	568	d 73.817	B250
388 A	d 57.531	B244	569	d 64.963	B246
390 A	d 63.500	B246	570	d 68.262	B248
394 A	D 110.000	B246, B248	572	D 139.992	B250, B252
395	d 63.500	B246	572 X	D 139.700	B252
395 A	d 66.675	B248	575	d 76.200	B250
395 S	d 66.675	B248	580	d 82.550	B252
397	d 60.000	B246	581	d 80.962	B252
399 A	d 68.262	B248	582	d 82.550	B252
414	D 88.501	B236	590 A	d 76.200	B250
418	d 38.100	B236	592	D 152.400	B256
432	D 95.250	B238	592 A	D 152.400	B250, B254, B256
432 A	D 95.250	B240	593	d 88.900	B254
436	d 46.038	B240	594	d 95.250	B256
438	d 44.450	B238	596	d 85.725	B254
453 A	D 107.950	B240	597	d 93.662	B256
453 X	D 104.775	B244	598	d 92.075	B256
460	d 44.450	B240	598 A	d 92.075	B256
462	d 57.150	B244	614 X	D 115.000	B244
469	d 57.150	B244	622 X	d 55.000	B244
472	D 120.000	B248, B250	632	D 136.525	B246, B250
472 A	D 120.000	B248	633	D 130.175	B246, B248, B250
478	d 65.000	B248	637	d 60.325	B246
480	d 68.262	B248	639	d 63.500	B246
484	d 70.000	B250	643	d 69.850	B248
492 A	D 133.350	B252, B254	644	d 71.438	B250
493	D 136.525	B250, B252, B254	645	d 71.438	B250
495	d 82.550	B252	652	D 152.400	B250, B252
495 A	d 76.200	B250	653	D 146.050	B248, B250, B252, B254
495 AX	d 76.200	B250	653 X	D 150.000	B250
496	d 80.962	B252	655	d 69.850	B248

Bearing No. BONE, CUP	Nominal Dimension (mm) d:BONE (Bore Dia.) D:CUP (Outside Dia.)	Pages
657	d 73.025	B250
658	d 74.612	B250
659	d 76.200	B250
661	d 79.375	B252
663	d 82.550	B252
664	d 84.138	B254
665	d 85.725	B254
665 A	d 85.725	B254
672	D 168.275	B254, B256, B258
677	d 85.725	B254
681	d 92.075	B256
683	d 95.250	B256
685	d 98.425	B256
687	d 101.600	B258
742	D 150.089	B248, B252, B254
743	D 150.000	B252
745 A	d 69.850	B248
749	d 85.026	B254
749 A	d 82.550	B252
749 S	d 85.026	B254
750	d 79.375	B252
752	D 161.925	B252, B254
753	D 168.275	B252, B254
757	d 82.550	B252
758	d 85.725	B254
759	d 88.900	B254
760	d 90.488	B254
766	d 88.900	B254
772	D 180.975	B256, B258
776	d 95.250	B256
779	d 98.425	B256
780	d 101.600	B258
782	d 104.775	B258
787	d 104.775	B258
792	D 206.375	B260
795	d 120.650	B260
797	d 130.000	B260
799	d 128.588	B260
799 A	d 130.175	B260
832	D 168.275	B252, B254
837	d 76.200	B252
842	d 82.550	B252
843	d 76.200	B252
850	d 88.900	B254
854	D 190.500	B254, B256, B258
855	d 88.900	B254
857	d 92.075	B256
861	d 101.600	B258
864	d 95.250	B256
866	d 98.425	B256
932	D 212.725	B258
938	d 114.300	B258
1220	D 57.150	B228
1280	d 22.225	B228

Bearing No. BONE, CUP	Nominal Dimension (mm) d:BONE (Bore Dia.) D:CUP (Outside Dia.)	Pages
1328	D 52.388	B228
1329	D 53.975	B228
1380	d 22.225	B228
1620	D 66.675	B234
1680	d 33.338	B234
1729	D 56.896	B228, B230
1755	d 22.225	B228
1779	d 23.812	B230
1922	D 57.150	B230
1988	d 28.575	B230
1997 X	d 26.988	B230
A2047	d 12.000	B228
A2126	D 31.991	B228
2523	D 69.850	B232, B234
2558	d 30.162	B232
2559	d 30.162	B232
2580	d 31.750	B232
2582	d 31.750	B232
2585	d 33.338	B234
2631	D 66.421	B232
2690	d 29.367	B232
2720	D 76.200	B236
2729	D 76.200	B236
2735 X	D 73.025	B236
2788	d 38.100	B236
2789	d 39.688	B236
2820	D 73.025	B234
2877	d 34.925	B234
2924	D 85.000	B240
2984	d 46.038	B240
3120	D 72.626	B232, B234
3188	d 31.750	B232
3197	d 33.338	B234
3320	D 80.167	B236
3386	d 39.688	B236
3420	D 79.375	B234, B236
3478	d 34.925	B234
3479	d 36.512	B236
3490	d 38.100	B236
3525	D 87.312	B238
3576	d 41.275	B238
3578	d 44.450	B238
3720	D 93.264	B238
3730	D 93.264	B242
3775	d 50.800	B242
3780	d 50.800	B242
3782	d 44.450	B238
3820	D 85.725	B238
3877	d 41.275	B238
3920	D 112.712	B246, B248
3926	D 112.712	B244, B246
3981	d 58.738	B244
3982	d 63.500	B246
3984	d 66.675	B248

Appendices

Bearing No. CONE, CUP	Nominal Dimension (mm) d:CONE (Bore Dia.) D:CUP (Outside Dia.)	Pages
3994	d 66.675	B248
A4050	d 12.700	B228
A4059	d 15.000	B228
A4138	D 34.988	B228
4335	D 90.488	B238
4388	d 41.275	B238
4535	D 104.775	B244
4595	d 53.975	B244
A5069	d 17.455	B228
A5144	D 36.525	B228
5335	D 103.188	B240
5356	d 44.450	B240
5535	D 122.238	B244, B246
5566	d 55.562	B244
5582	d 60.325	B246
5584	d 63.500	B246
5735	D 135.733	B250, B252
5760	d 76.200	B250
5795	d 77.788	B252
A6062	d 15.875	B228
A6067	d 16.993	B228
A6075	d 19.050	B228
A6157	D 39.992	B228
6220	D 127.000	B242, B244
6279	d 50.800	B242
6280	d 53.975	B244
6320	D 135.755	B246, B248
6376	d 60.325	B246
6379	d 65.088	B248
6420	D 149.225	B244, B248, B250
6454	d 69.850	B248
6455	d 57.150	B244
6460	d 73.025	B250
6461	d 76.200	B250
6535	D 161.925	B250, B252, B254
6536	D 161.925	B250
6559	d 82.550	B252
6575	d 76.200	B250
6576	d 76.200	B250
6580	d 88.900	B254
9121	D 152.400	B246, B248
9180	d 61.912	B246
9185	d 68.262	B248
9220	D 161.925	B250
9285	d 76.200	B250
9320	D 177.800	B252
9321	D 171.450	B252, B254
9378	d 76.200	B252
9380	d 76.200	B252
9385	d 84.138	B254
02420	D 68.262	B230, B232
02473	d 25.400	B230
02474	d 28.575	B230
02475	d 31.750	B232

Bearing No. CONE, CUP	Nominal Dimension (mm) d:CONE (Bore Dia.) D:CUP (Outside Dia.)	Pages
02820	D 73.025	B230, B234
02872	d 28.575	B230
02878	d 34.925	B234
03062	d 15.875	B228
03162	D 41.275	B228
05062	d 15.875	B228
05068	d 17.462	B228
05075	d 19.050	B228
05079	d 19.990	B228
05175	D 44.450	B228
05185	D 47.000	B228
07079	d 20.000	B228
07087	d 22.225	B228
07097	d 25.000	B230
07098	d 24.981	B230
07100	d 25.400	B230
07100SA	d 25.400	B230
07196	D 50.005	B228, B230
07204	D 51.994	B228, B230
07205	D 52.001	B230
08118	d 30.162	B232
08125	d 31.750	B232
08231	D 58.738	B232
09062	d 15.875	B228
09067	d 19.050	B228
09074	d 19.050	B228
09078	d 19.050	B228
09081	d 20.625	B228
09194	D 49.225	B228
09195	D 49.225	B228
09196	D 49.225	B228
11162	d 41.275	B238
11300	D 76.200	B238
11520	D 42.862	B228
11590	d 15.875	B228
LM11710	D 39.878	B228
LM11749	d 17.462	B228
LM11910	D 45.237	B228
LM11949	d 19.050	B228
12168	d 42.862	B238
12303	D 76.992	B238
12520	D 49.225	B228
12580	d 20.638	B228
M12610	D 50.005	B228
M12648	d 22.225	B228
M12649	d 21.430	B228
LM12710	D 45.237	B228
LM12711	D 45.975	B228
LM12749	d 22.000	B228
13175	d 44.450	B238
13181	d 46.038	B240
13318	D 80.962	B238, B240
13620	D 69.012	B236
13621	D 69.012	B236

Bearing No. BONE, CUP	Nominal Dimension (mm) d: BONE (Bore Dia.) D: CUP (Outside Dia.)	Pages
13685	d 38.100	B236
13687	d 38.100	B236
13830	D 63.500	B236
13889	d 38.100	B236
14123 A	d 31.750	B232
14125 A	d 31.750	B232
14130	d 33.338	B234
14131	d 33.338	B234
14137 A	d 34.925	B234
14138 A	d 34.925	B234
14139	d 34.976	B234
14274	D 69.012	B232, B234
14276	D 69.012	B232, B234
14283	D 72.085	B234
15100	d 25.400	B230
15101	d 25.400	B230
15106	d 26.988	B230
15112	d 28.575	B230
15113	d 28.575	B230
15116	d 30.112	B232
15117	d 30.000	B232
15118	d 30.213	B232
15119	d 30.213	B232
15120	d 30.213	B232
15123	d 31.750	B232
15125	d 31.750	B232
15126	d 31.750	B232
15245	D 62.000	B230, B232
15250	D 63.500	B232
15250 X	D 63.500	B230
15520	D 57.150	B230
15523	D 60.325	B230
15578	d 25.400	B230
15580	d 26.988	B230
16150	d 38.100	B236
16284	D 72.238	B236
16929	D 74.988	B238
16986	d 43.000	B238
17098	d 24.981	B230
17118	d 30.000	B232
17244	D 62.000	B230, B232
17520	D 42.862	B228
17580	d 15.875	B228
17831	D 79.985	B240
17887	d 45.230	B240
18200	d 50.800	B242
18337	D 85.725	B242
18520	D 73.025	B236
18590	d 41.275	B236
18620	D 79.375	B240
18690	d 46.038	B240
18720	D 85.000	B242
18790	d 50.800	B242
19138	d 34.976	B234

Bearing No. BONE, CUP	Nominal Dimension (mm) d: BONE (Bore Dia.) D: CUP (Outside Dia.)	Pages
19150	d 38.100	B236
19268	D 68.262	B234, B236
21075	d 19.050	B228
21212	D 53.975	B228
L21511	D 34.988	B228
L21549	d 15.875	B228
22168	d 42.862	B238
22325	D 82.550	B238
23100	d 25.400	B230
23256	D 65.088	B248
23621	D 73.025	B234
23691	d 35.000	B234
24720	D 76.200	B234
24721	D 76.200	B238
24780	d 41.275	B238
25520	D 82.931	B238, B240
25521	D 83.058	B238
25523	D 82.931	B238, B240
25577	d 42.875	B238
25578	d 42.862	B238
25580	d 44.450	B238
25584	d 44.983	B240
25590	d 45.618	B240
25820	D 73.025	B234
25821	D 73.025	B234, B236
25877	d 34.925	B234
25878	d 34.925	B234
25880	d 36.487	B236
26118	d 30.000	B232
26131	d 33.338	B234
26283	D 72.000	B232, B234
26820	D 80.167	B238
26822	D 79.375	B238
26823	D 76.200	B238
26882	d 41.275	B238
26884	d 42.875	B238
27620	D 125.412	B252
27687	d 82.550	B252
27689	d 83.345	B252
27690	d 83.345	B252
27820	D 80.035	B236
27880	d 38.100	B236
28138	d 34.976	B234
28315	D 80.000	B234
28521	D 92.075	B242
28580	d 50.800	B242
28584	d 52.388	B242
28622	D 97.630	B244
28680	d 55.562	B244
28920	D 101.600	B246
28921	D 100.000	B246
28985	d 60.325	B246
29520	D 107.950	B246
29586	d 63.500	B246

Appendices

Bearing No. CONE, CUP	Nominal Dimension (mm) d:CONE (Bore Dia.) D:CUP (Outside Dia.)	Pages
29620	D 112.712	B248, B250
29630	D 120.650	B248
29675	d 69.850	B248
29685	d 73.025	B250
LM 29710	D 65.088	B236
LM 29711	D 65.088	B236
LM 29748	d 38.100	B236
LM 29749	d 38.100	B236
31520	D 76.200	B234
31594	d 34.925	B234
33262	d 66.675	B248
33275	d 69.850	B248
33281	d 71.438	B250
33287	d 73.025	B250
JHM 33410	D 55.000	B230
JHM 33449	d 24.000	B230
33462	D 117.475	B248, B250
33821	D 95.250	B242
33889	d 50.800	B242
34300	d 76.200	B250
34306	d 77.788	B252
34478	D 121.442	B250, B252
36620	D 193.675	B260
36690	d 146.500	B260
36920	D 227.012	B262
36990	d 177.800	B262
37425	d 107.950	B258
37625	D 158.750	B258
M 38510	D 66.675	B234
M 38511	D 65.987	B234
M 38547	d 35.000	B234
M 38549	d 34.925	B234
39236	d 60.000	B246
39250	d 63.500	B246
39412	D 104.775	B246
39520	D 112.712	B246, B248
39521	D 112.712	B248
39585	d 63.500	B246
39590	d 66.675	B248
41100	d 25.400	B230
41125	d 28.575	B230
41126	d 28.575	B230
41286	D 72.626	B230
42350	d 88.900	B254
42362	d 92.075	B256
42368	d 93.662	B256
42375	d 95.250	B256
42376	d 95.250	B256
42381	d 96.838	B256
42584	D 148.430	B256
42587	D 149.225	B254, B256
42620	D 127.000	B250, B252
42687	d 76.200	B250
42688	d 76.200	B250

Bearing No. BONE, CUP	Nominal Dimension (mm) d:BONE (Bore Dia.) D:CUP (Outside Dia.)	Pages
42690	d 77.788	B252
43118	d 30.162	B232
43131	d 33.338	B234
43300	D 76.200	B232
43312	D 79.375	B234
44143	d 36.512	B236
44150	d 38.100	B236
44157	d 40.000	B236
44162	d 41.275	B238
44348	D 88.501	B236, B238
L 44610	D 50.292	B230
L 44640	d 23.812	B230
L 44643	d 25.400	B230
L 44649	d 26.988	B230
45220	D 104.775	B244
45221	D 104.775	B244
45289	d 57.150	B244
L 45410	D 50.292	B232
L 45449	d 29.000	B232
46143	d 36.512	B236
46162	d 41.275	B238
46176	d 44.450	B238
46368	D 93.662	B236, B238
46720	D 225.425	B260
46780	d 158.750	B260
47420	D 120.000	B248, B250
47487	d 69.850	B248
47490	d 71.438	B250
47620	D 133.350	B250, B252
47680	d 76.200	B250
47685	d 82.550	B252
47686	d 82.550	B252
47687	d 82.550	B252
47820	D 146.050	B256
47890	d 92.075	B256
47896	d 95.250	B256
48120	D 161.925	B258
48190	d 107.950	B258
48220	D 182.562	B260
48282	d 120.650	B260
48286	d 123.825	B260
48290	d 127.000	B260
48320	D 190.500	B260
48385	d 133.350	B260
48393	d 136.525	B260
LM 48510	D 65.088	B234
LM 48511	D 65.088	B234
LM 48548	d 34.925	B234
48620	D 200.025	B260
48685	d 142.875	B260
49175	d 44.450	B238
49176	d 44.450	B238
49368	D 93.662	B238
49520	D 101.600	B242

Bearing No. BONE, CUP	Nominal Dimension (mm) d: BONE (Bore Dia.) D: CUP (Outside Dia.)	Pages
49585	d 50.800	B242
52387	d 98.425	B256
52393	d 100.012	B256
52400	d 101.600	B258
52618	D 157.162	B256, B258
52637	D 161.925	B256, B258
53150	d 38.100	B236
53162	d 41.275	B238
53176	d 44.450	B240
53177	d 44.450	B240
53178	d 44.450	B240
53375	D 95.250	B236, B240
53387	D 98.425	B238, B240
55175	d 44.450	B240
55187	d 47.625	B240
55200	d 50.800	B242
55200 C	d 50.800	B242
55206	d 52.388	B242
55437	D 111.125	B240, B242
55443	D 112.712	B240
56418	d 106.362	B258
56425	d 107.950	B258
56650	D 165.100	B258
59200	d 50.800	B242
59429	D 108.966	B242
64433	d 109.992	B258
64450	d 114.300	B258
64700	D 177.800	B258
65200	d 50.800	B242
65212	d 53.975	B244
65237	d 60.325	B246
65320	D 114.300	B240
65385	d 44.450	B240
65500	D 127.000	B242, B244, B246
66187	d 47.625	B240
66462	D 117.475	B240
66520	D 122.238	B244, B246
66584	d 53.975	B244
66585	d 60.000	B246
66587	d 57.150	B244
LM67010	D 59.131	B230, B232
LM67043	d 28.575	B230
LM67048	d 31.750	B232
67320	D 203.200	B260
67322	D 196.850	B260
67388	d 127.000	B260
67389	d 130.175	B260
67390	d 133.350	B260
67720	D 247.650	B260, B262
67780	d 165.100	B260
67787	d 174.625	B262
67790	d 177.800	B262
67820	D 266.700	B262
67885	d 190.500	B262

Bearing No. BONE, CUP	Nominal Dimension (mm) d: BONE (Bore Dia.) D: CUP (Outside Dia.)	Pages
67920	D 282.575	B262
67983	d 203.200	B262
67985	d 206.375	B262
L68110	D 59.131	B234
L68111	D 59.975	B234
L68149	d 35.000	B234
68450	d 114.300	B258
68462	d 117.475	B258
68709	D 180.000	B258
68712	D 180.975	B258
JL69310	D 63.000	B236
JL69349	d 38.000	B236
71412	d 104.775	B258
71425	d 107.950	B258
71437	d 111.125	B258
71450	d 114.300	B258
71453	d 115.087	B258
71750	D 190.500	B258
72187	d 47.625	B240
72200	d 50.800	B242
72200 C	d 50.800	B242
72212	d 53.975	B244
72212 C	d 53.975	B244
72218	d 55.562	B244
72218 C	d 55.562	B244
72225 C	d 57.150	B244
72487	D 123.825	B240, B242, B244
LM72810	D 47.000	B230
LM72849	d 22.606	B230
74500	d 127.000	B260
74525	d 133.350	B260
74537	d 136.525	B260
74550	d 139.700	B260
74850	D 215.900	B260
74856	D 217.488	B260
77375	d 95.250	B256
77675	D 171.450	B256
78225	d 57.150	B244
78250	d 63.500	B246
LM78310	D 62.000	B234
LM78310 A	D 62.000	B234
LM78349	d 35.000	B234
78537	D 136.525	B246
78551	D 140.030	B244, B246
78571	D 144.983	B244
HM81610	D 47.000	B228
HM81649	d 16.000	B228
M84210	D 59.530	B230
M84249	d 25.400	B230
M84510	D 57.150	B230
M84548	d 25.400	B230
M86610	D 64.292	B230, B232
M86643	d 25.400	B230
M86647	d 28.575	B230

Appendices

Bearing No. CONE, CUP	Nominal Dimension (mm) d:CONE (Bore Dia.) D:CUP (Outside Dia.)	Pages
M 86648 A	d 30.955	B232
M 86649	d 30.162	B232
M 88010	D 68.262	B232, B234
M 88043	d 30.162	B232
M 88046	d 31.750	B232
M 88048	d 33.338	B234
HM 88510	D 73.025	B232, B234
HM 88542	d 31.750	B232
HM 88547	d 33.338	B234
HM 88610	D 72.233	B230, B232, B234, B236
HM 88630	d 25.400	B230
HM 88638	d 32.000	B232
HM 88648	d 35.717	B236
HM 88649	d 34.925	B234
HM 89410	D 76.200	B234, B236
HM 89411	D 76.200	B234
HM 89443	d 33.338	B234
HM 89444	d 33.338	B234
HM 89446	d 34.925	B234
HM 89446 A	d 34.925	B234
HM 89449	d 36.512	B236
99100	D 254.000	B260
99550	d 139.700	B260
99575	d 146.050	B260
99587	d 149.225	B260
99600	d 152.400	B260
LM 102910	D 73.431	B240
LM 102949	d 45.242	B240
JLM 104910	D 82.000	B242
LM 104911	D 82.550	B242
LM 104911 A	D 82.550	B242
LM 104912	D 82.931	B242
LM 104947 A	d 50.000	B242
JLM 104948	d 50.000	B242
LM 104949	d 50.800	B242
M 201011	D 73.025	B236
M 201047	d 39.688	B236
JM 205110	D 90.000	B242
JM 205149	d 50.000	B242
JM 207010	D 95.000	B244
JM 207049	d 55.000	B244
JH 211710	D 120.000	B248
JH 211749	d 65.000	B248
HM 212010	D 122.238	B246, B248
HM 212011	D 122.238	B246, B248
HM 212044	d 60.325	B246
HM 212046	d 63.500	B246
HM 212047	d 63.500	B246
HM 212049	d 66.675	B248
JH 217210	D 150.000	B254
JH 217249	d 85.000	B254
HM 218210	D 147.000	B254
HM 218248	d 90.000	B254
HH 221410	D 190.500	B254, B256, B258

Bearing No. CONE, CUP	Nominal Dimension (mm) d:CONE (Bore Dia.) D:CUP (Outside Dia.)	Pages
HH 221432	d 87.312	B254
HH 221434	d 88.900	B254
HH 221440	d 95.250	B256
HH 221442	d 98.425	B256
HH 221447	d 99.982	B256
HH 221449	d 101.600	B258
HH 224310	D 212.725	B258
HH 224335	d 101.600	B258
HH 224340	d 107.950	B258
HH 224346	d 114.300	B258
M 224710	D 174.625	B260
M 224748	d 120.000	B260
LL 225710	D 165.895	B260
LL 225749	d 127.000	B260
HM 231110	D 236.538	B260
HM 231140	d 146.050	B260
M 236810	D 260.350	B262
M 236849	d 177.800	B262
LM 300811	D 68.000	B236
LM 300849	d 41.000	B236
L 305610	D 80.962	B242
L 305649	d 50.800	B242
JH 307710	D 110.000	B244
JH 307749	d 55.000	B244
JHM 318410	D 155.000	B254
JHM 318448	d 90.000	B254
L 327210	D 177.008	B260
L 327249	d 133.350	B260
LM 328410	D 187.325	B260
LM 328448	d 139.700	B260
H 414210	D 136.525	B248, B250
H 414245	d 68.262	B248
H 414249	d 71.438	B250
JH 415610	D 145.000	B250
JH 415647	d 75.000	B250
LM 501310	D 73.431	B236
LM 501314	D 73.431	B236
LM 501349	d 41.275	B236
LM 503310	D 75.000	B240
LM 503349	d 46.000	B240
HH 506310	D 114.300	B242
HH 506348	d 49.212	B242
JLM 506810	D 90.000	B244
JLM 506849	d 55.000	B244
JLM 508710	D 95.000	B246
JLM 508748	d 60.000	B246
JM 511910	D 110.000	B248
JM 511946	d 65.000	B248
JM 515610	D 130.000	B252
JM 515649	d 80.000	B252
HM 516410	D 133.350	B252
HM 516448	d 82.550	B252
JHM 516810	D 140.000	B254
JHM 516849	d 85.000	B254

Bearing No. CONE, CUP	Nominal Dimension (mm) d: CONE (Bore Dia.) D: CUP (Outside Dia.)	Pages
HM 518410	D 152.400	B254
HM 518445	d 88.900	B254
LM 522510	D 159.987	B258
LM 522546	d 107.950	B258
LM 522548	d 109.987	B258
LM 522549	d 109.987	B258
JHM 522610	D 180.000	B258
JHM 522649	d 110.000	B258
JHM 534110	D 230.000	B262
JHM 534149	d 170.000	B262
LM 603011	D 77.788	B240
LM 603012	D 77.788	B240
LM 603049	d 45.242	B240
L 610510	D 94.458	B246
L 610549	d 63.500	B246
JM 612910	D 115.000	B250
JM 612949	d 70.000	B250
LM 613410	D 112.712	B248
LM 613449	d 69.850	B248
HM 617010	D 142.138	B254
HM 617049	d 85.725	B254
L 623110	D 152.400	B258
L 623149	d 114.300	B258
JLM 710910	D 105.000	B248
JLM 710949	d 65.000	B248
JLM 714110	D 115.000	B250
JLM 714149	d 75.000	B250
JM 714210	D 120.000	B250
JM 714249	d 75.000	B250
H 715311	D 136.525	B246, B248, B250
H 715334	d 61.912	B246
H 715340	d 65.088	B248
H 715341	d 66.675	B248
H 715343	d 68.262	B248
H 715345	d 71.438	B250
JM 716610	D 130.000	B254
JM 716648	d 85.000	B254
JM 716649	d 85.000	B254
JM 718110	D 145.000	B254
JM 718149	d 90.000	B254
JM 719113	D 150.000	B256
JM 719149	d 95.000	B256
JM 720210	D 155.000	B256
JHM 720210	D 160.000	B256
JM 720249	d 100.000	B256
JHM 720249	d 100.000	B256
JL 724314	D 170.000	B260
JL 724348	d 120.000	B260
JL 725316	D 175.000	B260
JL 725346	d 125.000	B260
JM 734410	D 240.000	B262
JM 734449	d 170.000	B262
JM 738210	D 260.000	B262
JM 738249	d 190.000	B262

Bearing No. CONE, CUP	Nominal Dimension (mm) d: CONE (Bore Dia.) D: CUP (Outside Dia.)	Pages
HM 801310	D 82.550	B236
HM 801346	d 38.100	B236
M 802011	D 82.550	B238
M 802048	d 41.275	B238
HM 803110	D 88.900	B238
HM 803145	d 41.275	B238
HM 803146	d 41.275	B238
HM 803149	d 44.450	B238
M 804010	D 88.900	B240
M 804049	d 47.625	B240
HM 804810	D 95.250	B238, B240, B242
HM 804840	d 41.275	B238
HM 804843	d 44.450	B240
HM 804846	d 47.625	B240
HM 804848	d 48.412	B242
HM 804849	d 48.412	B242
HM 807010	D 104.775	B240, B242
HM 807011	D 104.775	B242
JHM 807012	D 105.000	B242
HM 807040	d 44.450	B240
HM 807044	d 49.212	B242
JHM 807045	d 50.000	B242
HM 807046	d 50.800	B242
JLM 813010	D 110.000	B250
JLM 813049	d 70.000	B250
JLM 820012	D 150.000	B256
JLM 820048	d 100.000	B256
JM 822010	D 165.000	B258
JM 822049	d 110.000	B258
JHM 840410	D 300.000	B262
JHM 840449	d 200.000	B262
HM 903210	D 95.250	B240
HM 903247	d 44.450	B240
HM 903249	d 44.450	B240
HM 911210	D 130.175	B244
HM 911242	d 53.975	B244
H 913810	D 146.050	B246, B248
H 913842	d 61.912	B246
H 913849	d 69.850	B248

NSK Sales Offices – Europe, Middle East and Africa

UK

NSK UK Ltd.
Northern Road, Newark
Nottinghamshire NG24 2JF
Tel. +44 (0) 1636 605123
Fax +44 (0) 1636 643276
info-uk@nsk.com

France & Benelux

NSK France S.A.S.
Quartier de l'Europe
2, rue Georges Guynemer
78283 Guyancourt Cedex
Tel. +33 (0) 1 30573939
Fax +33 (0) 1 30570001
info-fr@nsk.com

**Germany, Austria,
Switzerland, Nordic**

NSK Deutschland GmbH
Harkortstraße 15
40880 Ratingen
Tel. +49 (0) 2102 4810
Fax +49 (0) 2102 4812290
info-de@nsk.com

Italy

NSK Italia S.p.A.
Via Garibaldi, 215
20024 Garbagnate
Milanese (MI)
Tel. +39 02 995 191
Fax +39 02 990 25 778
info-it@nsk.com

Middle East

NSK Bearings Gulf Trading Co.
JAFZA View 19, Floor 24 Office 2/3
Jebel Ali Downtown,
PO Box 262163
Dubai, UAE
Tel. +971 (0) 4 804 8205
Fax +971 (0) 4 884 7227
info-me@nsk.com

Poland & CEE

NSK Polska Sp. z o.o.
Warsaw Branch
Ul. Migdałowa 4/73
02-796 Warszawa
Tel. +48 22 645 15 25
Fax +48 22 645 15 29
info-pl@nsk.com

Russia

NSK Polska Sp. z o.o.
Russian Branch
Office I 703, Bldg 29,
18th Line of Vasilievskiy Ostrov,
Saint-Petersburg, 199178
Tel. +7 812 3325071
Fax +7 812 3325072
info-ru@nsk.com

South Africa

NSK South Africa (Pty) Ltd.
25 Galaxy Avenue
Linbro Business Park
Sandton 2146
Tel. +27 (011) 458 3600
Fax +27 (011) 458 3608
nsk-sa@nsk.com

Spain

NSK Spain, S.A.
C/ Tarragona, 161 Cuerdo Bajo
2^a Planta, 08014 Barcelona
Tel. +34 93 2892763
Fax +34 93 4335776
info-es@nsk.com

Turkey

NSK Rulmanları Orta Doğu Tic. Ltd. Şti
19 Mayıs Mah. Atatürk Cad.
Ulya Engin İş Merkezi No: 68/3 Kat. 6
PK.: 34736 - Kozyatağı - İstanbul
Tel. +90 216 4777111
Fax +90 216 4777174
turkey@nsk.com

Please also visit our website: www.nskeurope.com | Global NSK: www.nsk.com

